



Register your new Bosch now:
www.bosch-home.com/welcome



Washing machine
WAE24177UK ...



BOSCH

en Instruction Manual and Installation Instructions

Your new washing machine

You have chosen a Bosch washing machine.

Please take a few minutes to read and become familiar with the advantages of your washing machine.

To meet the high quality demands required by Bosch, every washing machine that leaves our factory is carefully checked to ensure that it functions correctly and is in perfect condition.

For more information on our products, accessories, replacement parts and services, see our website www.bosch-home.com or contact our after-sales service centres.

If the operating and installation instructions describe different models, any differences will be pointed out at the relevant points in the text.



Read these operating and installation instructions before switching on the washing machine.

Display rules

Warning!

This combination of symbol and signal word indicates a possibly dangerous situation. Not heeding the warning can cause death or injuries.

Caution!

This signal word indicates a possibly dangerous situation. Not heeding the caution can cause property and/or environmental damage.

Note/tip

Information about the optimum use of the appliance/any other useful information.











1. 2. 3. / a) b) c)





The steps are represented by numbers or letters.





■ / -

Lists are represented by a small box or a dash.

Contents

	Intended use	4
	Safety instructions	5
	Electrical safety	5
	Risk of injury	5
	Safety for children	5
	Environmental protection	6
	Packaging/used appliance	6
	Tips on economical use	6
	Main points in brief	7
	Getting to know the appliance .	8
	Washing machine	8
	Control panel	9
	Laundry	10
	Sorting laundry	10
	Prepare the laundry	10
	Detergent	11
	Correct selection of detergent	11
	Saving energy and detergent	11
	Overview of programmes	12
	Programmes on the programme selector	12
	Starching	13
	Dyeing/bleaching	13
	Soaking	13
	Programme default settings ..	14
	Ⓢ Spin speed	14
	Additional programme settings 14	
	⌚ Speed*	14
	Ⓢ Eco*	14
	👕 Easy-Iron	14
	👕 Rinse plus*	14
	👕 Water plus*	14

	Operating the appliance	15
	Preparing the washing machine	15
	Select programme/switch on the appliance	15
	Change the programme default settings	15
	Select additional programme settings	15
	Placing laundry into the drum	15
	Measure and add detergent and care products	16
	Start the programme	17
	Adding laundry	17
	Changing the programme	17
	Cancel the programme	17
	Programme end during rinse hold ..	17
	Programme end	18
	Removing laundry/switching off the appliance	18
	Sensors	18
	Automatic load sensing	18
	Unbalanced load detection system ..	18
	Setting the signal	19
	Cleaning and maintenance	20
	Machine housing/control panel	20
	Drum	20
	Descaling	20
	Detergent drawer and housing	20
	Detergent solution pump blocked ..	21
	The drain hose at the siphon is blocked	22
	Filter in the water supply blocked ..	22
	Faults and what to do about them.	23
	Emergency release	23
	Information about the indicator lights	24
	Faults and what to do about them. .	24

	After-sales service	26
	Consumption rates	27
	Energy and water consumption, programme duration and residual moisture for the main washing programmes	27
	Efficiency test programmes for cotton fabrics	28
	Technical data	28
	Positioning and connecting	29
	Included with the appliance	29
	Safety instructions	29
	Installation surface	30
	Installation on a base or a wooden joist floor	30
	Installing the appliance in a kitchenette	30
	Removing the transport locks	30
	Hose and cable lengths	31
	Water inlet	32
	Water outlet	33
	Levelling	34
	Electrical connection	34
	Before washing for the first time	35
	Transportation	35

Intended use

- For private domestic use only.
- The washing machine is suitable for washing machine-washable fabrics and hand-washable wool in detergent solution.
- To be operated with cold mains water and standard detergents and care products which are suitable for use in washing machines.
- When measuring the amount of all detergents/additives/care products and cleaning agents, always check the manufacturer's instructions.
- The washing machine may be used by children over the age of 8 years old and by persons with reduced physical, sensory or mental capacity or by persons with a lack of experience or knowledge if they **are supervised** or have been **instructed** by a responsible person. Children must not carry out any cleaning or maintenance work without supervision.
- Keep pets away from the washing machine.

Read the Instruction Manual and Installation Instructions and all other information supplied with the washing machine and use the machine accordingly.

Retain the documents for subsequent use.

Safety instructions

Electrical safety

Warning **Risk of death!**

There is a risk of electric shock if you touch live components.

- Never touch or hold the mains plug with wet hands.
- Only pull out the mains cable by the plug and never by the cable, as this could damage it.

Risk of injury

Warning **Risk of injury!**

- If the washing machine is lifted by protruding components (e.g. the washing machine door), the components may break off and cause injuries. Do not lift the washing machine by protruding parts.
- If you climb onto the washing machine, the worktop may break and cause injuries. Do not climb onto the washing machine.
- If you lean/sit on the opened washing machine door, the washing machine may tip over and cause injuries. Do not lean on the washing machine door when it is open.

- Reaching into the drum while it is still rotating may cause hand injuries. Do not reach into the drum while it is rotating. Wait until the drum has stopped rotating.

Warning **Risk of scalding!**

When you are washing at high temperatures, there is a risk of scalding if you come into contact with hot detergent solution (e.g. when draining hot detergent solution into a washbasin). Do not reach into the hot detergent solution.

Safety for children

Warning **Risk of death!**

If children play with the washing machine, they may get into life-threatening situations or injure themselves.

- Do not leave children unattended near the washing machine.
- Do not let children play with the washing machine.

Warning **Risk of death!**

Children may lock themselves in appliances, putting their lives at risk.

When appliances have reached the end of their service life:

- Pull out the mains plug.

- Cut through the mains cable and remove it, along with the plug.
- Destroy the lock on the washing machine door.

 **Warning**
Risk of suffocation!

Children may become wrapped in packaging/film or packing parts if allowed to play with them, or they may pull them over their heads and suffocate. Keep packaging, film and packaging parts out of the reach of children.

 **Warning**
Risk of poisoning!

Detergents and care products may be poisonous if consumed. Keep detergents and care products out of the reach of children.

 **Warning**
Eye/skin irritation!

Detergents and care products may cause irritation if they come into contact with the eyes or skin. Keep detergents and care products out of the reach of children.

 **Warning**
Risk of injury!

When you wash at high temperatures, the glass in the washing machine door becomes hot.

Do not let children touch the hot washing machine door.

 **Environmental protection**

Packaging/used appliance











Dispose of packaging in an environmentally-responsible manner. This appliance is labelled in accordance with European Directive 2012/19/EU concerning used electrical and electronic appliances (waste electrical and electronic equipment - WEEE). The guideline determines the framework for the return and recycling of used appliances as applicable throughout the EU.

Tips on economical use

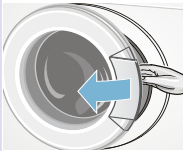
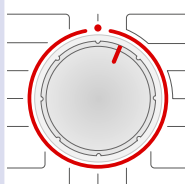
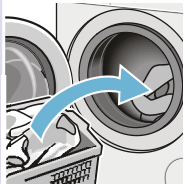
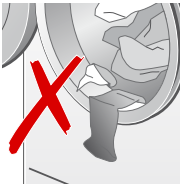
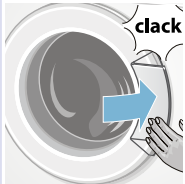
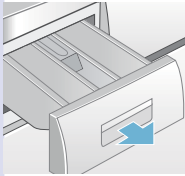
- Always fill the appliance with the maximum amount of laundry for each programme. Overview of programmes → *Page 12*
- Wash normally soiled laundry without a prewash.
- If the laundry is subsequently dried in a tumble dryer, select the spin speed according to the tumble dryer manufacturer's instructions.
- The selectable temperatures apply to the care labels on the textiles. The temperatures in the machine may deviate from this so that you get the optimum mix of energy-saving and washing results.

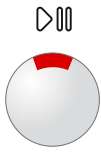

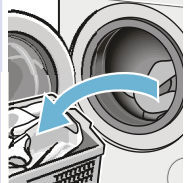
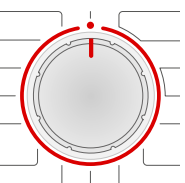
Main points in brief

1				
	Connect the mains plug.	Turn on the water tap (for models without Aqua-Stop).	Sort the laundry.	Open the washing machine door.
2				
	Select a programme, e.g. Cottons .	Load the laundry.	Do not trap any items of laundry.	Close the washing machine door.
3				
	Add detergent.	Change the programme default settings, if necessary.	Select additional settings, if necessary.	Start the programme.
4				
	Programme end.	Open the washing machine door and remove the laundry.	Turn the programme selector to ●.	Turn off the water tap (for models without Aqua-Stop).

Getting to know the appliance

Washing machine

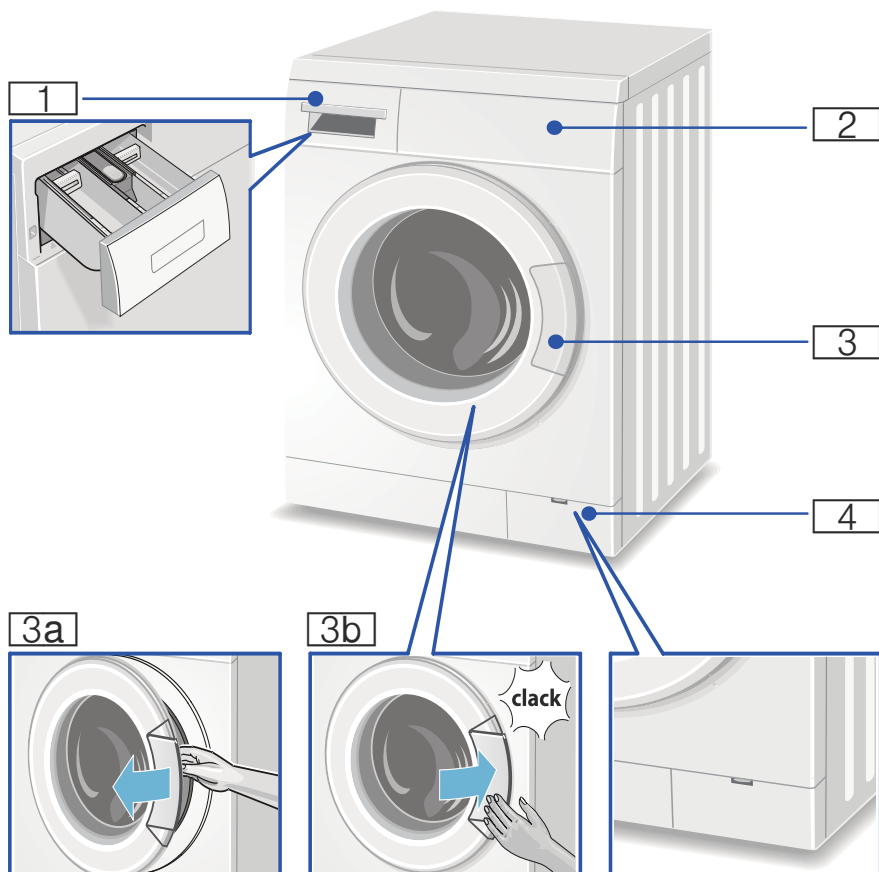

1 Detergent drawer → *Page 16*

2 Controls/display elements

3 Washing machine door with door handle

3a Open the washing machine door

3b Close the washing machine door

4 Service flap

Control panel

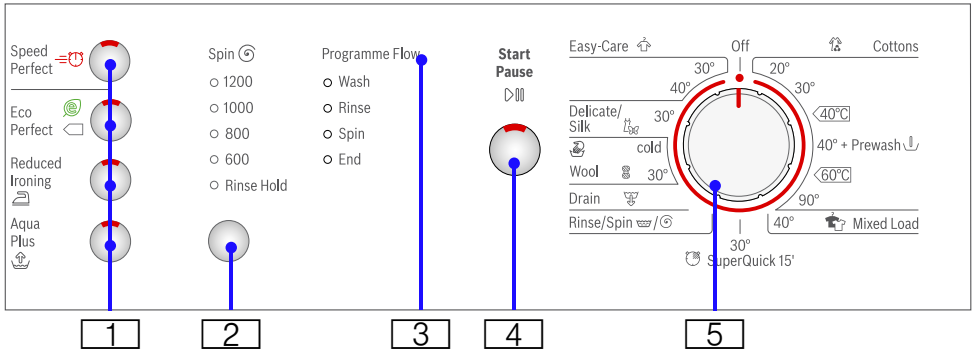

1 = **Speed***, **Eco***, **Easy Iron**, **Rinse Plus** / **Aqua plus*** additional programme settings (* depending on the model)

Overview of all additional programme settings

2 **Spin speed** for changing the default programme setting

= **Rinse stop**

3 **Status indicators**

Programme sequence indicators: **Wash**, **Rinse**, **Spin**, **Ready**

4 **Start/Pause** for starting, interrupting (adding laundry) and cancelling a programme





5 Programme selector for selecting a programme and for switching the machine on and off



Laundry

Sorting laundry

Sort your laundry according to the care instructions and manufacturer's information on the care labels, depending on:

- Type of fabric/fibre
- Colour
 - Note:** Laundry can discolour or not be cleaned correctly. Wash white and coloured laundry separately. Wash new bright fabrics separately the first time you wash them.
- Soiling
 - Wash laundry with the same level of soiling together. You can find examples of levels of soiling on → *Page 11*
 - **Light:** Do not pre-wash, select the **Speed** setting if necessary
 - **Normal**
 - **Heavy:** Load less laundry, select a programme with pre-wash
 - **Stains:** Remove/pretreat stains while they are fresh. First, dab the stain with soapy water/do not rub. Then wash the items of laundry with the appropriate programme. Stubborn/dried-in stains can sometimes only be removed with several washes.
- Symbols on the care labels
 - The numbers in the symbols indicate the maximum washing temperature which may be used.
 - : Suitable for a normal washing process; e.g. **Cottons** programme
 - : A gentle washing process is required; e.g. **Easy-Care** programme
 - : An especially gentle washing process is required; e.g. **Delicate/Silk** programme
 - : Suitable for washing by hand; e.g.  / **Wool** programme

- : Do not wash the laundry in the machine.

Prepare the laundry

Caution!

Damage to the appliance/fabrics

Foreign objects (e.g. coins, paperclips, needles, nails) may damage the laundry or components in the washing machine.

You should therefore note the following tips when preparing your laundry:

- Empty any pockets.

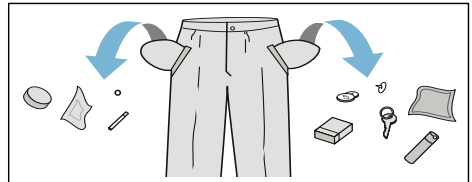

- Look out for metal items (paperclips, etc.) and remove them.
- Wash delicates in a laundry bag (tights, underwired bras, etc.).
- Close any zips, button up any cover buttons.
- Brush sand out of pockets and collars.
- Remove curtain fittings or place curtains in a laundry bag.

Detergent

Correct selection of detergent

The care label is crucial for selecting the correct detergent, temperature and treatment of the laundry. → See also www.sartex.ch

Visit www.cleanright.eu to find further information on detergents, care products and cleaning agents for domestic use.

- **Standard detergent with optical brighteners**
Suitable for heat-resistant white laundry made from linen or cotton
Programme: Cottons /
20 °C - max. 90 °C
- **Detergent for colours without bleach or optical brighteners**
Suitable for coloured laundry made from linen or cotton
Programme: Cottons /
20 °C - max. 60 °C
- **Detergent for colours/delicates without optical brighteners**
Suitable for coloured laundry made from easy-care fibres, synthetic fibres
Programme: Easy-Care /
20 °C - max. 60 °C
- **Delicates**
Suitable for delicate, fine fabrics, silk or viscose
Programme: Delicates/Silk /
20 °C - max. 40 °C
- **Detergent for woollens**
Suitable for woollen fabrics
Programme: Woollens /
20 °C - max. 40 °C

Saving energy and detergent

































For light and normal soiling, you can save energy (lower washing temperature) and detergent.









Saving	Soiling/note
Reduced temperature and detergent quantity as per the recommended dosage	<p>Light No visible dirt or stains. Clothing has taken on some body odour, e.g.:</p> <ul style="list-style-type: none"> ■ Light summer/sports clothing (worn for a few hours) ■ T-shirts, shirts, blouses (worn for up to one day) ■ Guest bed linen and hand towels (used for one day)
	<p>Normal Visible dirt or a few light stains, e.g.:</p> <ul style="list-style-type: none"> ■ T-shirts, shirts, blouses (sweat soaked, worn a few times) ■ Towels, bedding (used for up to one week)
	<p>Heavy Dirt and/or stains clearly visible, e.g. tea towels, baby items, work clothing</p>
Temperature as per the care label and detergent quantity as per the recommended dosage for heavy soiling	

Note: When measuring the amount of all detergents/additives/care products and cleaning agents, please always check the manufacturer's instructions and information. → Page 16

Overview of programmes

Programmes on the programme selector

Programme/type of washing/instructions	Settings
<p>Name of the programme</p> <p>Brief explanation of the programme and for which fabrics it is suitable.</p>	<p>Max. load;</p> <p>* Reduced load for the  Speed setting</p> <p>Temperature that can be selected</p> <p>Spin speed that can be selected;</p> <p>** Max. spin speed, depending on the model</p> <p>Possible programme settings</p>
<p> Cottons</p> <p>Hard-wearing fabrics, heat-resistant fabrics made of cotton or linen</p> <p> Cottons 40 °C +  Prewash : Programme with prewash, prewash at 30 °C; divide detergent between compartments I and II</p> <p>Note: The  Speed setting is suitable as a short programme for lightly soiled laundry.</p>	<p>Max. 7 kg/4* kg</p> <p>20, 30, 40, 60, 90 °C</p> <p> ... 1400** rpm</p> <p>, , , / </p>
<p> Easy-Care</p> <p>Synthetic or blended fabrics</p>	<p>Max. 3 kg</p> <p>30, 40°C</p> <p> ... 1200** rpm</p> <p>, , , / </p>
<p> Mixed Load</p> <p>Mixed load of cottons and synthetic fabrics</p> <p>Notes</p> <ul style="list-style-type: none"> ■ Different types of laundry can be washed together. ■  Mixed Load 40 °C with maximum spin speed is ideal as a short programme. 	<p>Max. 3 kg</p> <p>40 °C</p> <p> ... 1200** rpm</p> <p>, , , / </p>
<p> Delicate/Silk</p> <p>For delicate, washable fabrics, e.g. made of silk, satin, synthetic fibres or blends (e.g. silk blouses, silk scarves)</p> <p>Notes</p> <ul style="list-style-type: none"> ■ For delicates or silk, use a detergent suitable for machine-washing. ■ No spin cycle between the rinse cycles 	<p>Max. 2 kg</p> <p>30 °C</p> <p> ... 800 rpm</p> <p>, , , / </p>

Programme/type of washing/instructions	Settings
 Wool Hand or machine-washable wool or rich-wool textiles. Especially gentle wash programme to prevent shrinkage, longer programme pauses (textiles rest in wash liquor)	Max. 2 kg cold, 30 °C  ... 800 rpm
Notes <ul style="list-style-type: none"> ■ Wool is of animal origin, e.g.: Angora, alpaca, llama, sheep. ■ For wool, use a detergent that is suitable for machine-washing. 	-
 Rinse / Spin Laundry washed by hand, Rinse plus/Aqua plus button activated Note: If you require spin only, deactivate the button	Max. 7 kg -  ... 1200** rpm 
 Drain Drain the rinsing water after a programme using the  setting (without final spin) for gentle treatment of delicate laundry	Max. 7 kg - - -
 SuperQuick 15' Extra-short programme of approx. 15 minutes, suitable for small items of lightly soiled laundry	Max. 2 kg 30 °C  ... 1200** rpm -

Starching

Note: Laundry must not be treated with fabric softener.

Starching is possible in all wash programmes if liquid starch is used. Measure starch into compartment  in accordance with the manufacturer's instructions (clean first if necessary).

Dyeing/bleaching

Dye should only be used in normal household quantities. Salt may damage stainless steel. Always follow the dye manufacturer's instructions.

Do **not** use the washing machine to bleach clothes.

Soaking

1. Pour soaking agent/detergent into compartment **II** in accordance with the manufacturer's instructions.
2. Turn the programme selector to **Cottons 30 °C** programme.
3. Select **Start/Pause**.
4. After approx. 10 minutes select **Start/Pause**.
5. After the required soaking time reselect **Start/Pause** if the programme is to be continued, or change the programme.

Notes

- Load laundry of the same colour.
- No additional detergent is required; the soaking solution is used for washing.

Programme default settings

The spin speed for all programmes is preset at the factory.

You can change the default settings as follows.

Spin speed

The spin speed for all programmes is preset at the factory.

You can change the default settings as follows.

Before and while the selected programme is running, the spin speed or **Rinse stop** (without final spin, laundry soaks in the last rinsing water) can be set. The effects depend on the programme progress.

The maximum selectable spin speed depends on the model and the set programme.

Additional programme settings

Speed*

For washing in a shorter time with a washing result comparable to that of the standard programme.

Note: Do not exceed the maximum load.

Overview of programmes → *Page 12*

Eco*

For saving energy with a washing result comparable to that of the standard programme.

Note: The washing temperature is lower than the selected temperature. For special hygiene requirements, we recommend selecting a higher temperature or the  **Speed** option.

Easy-Iron

Special spin sequence with subsequent fluffing. Gentle final spin – residual moisture in the laundry slightly increased.

Rinse plus*

Extra rinse. For areas with very soft water or to further improve the rinsing result.

Water plus*

Increased water level and additional rinse cycle, extended washing time. For areas with very soft water or to further improve the rinsing result.

(* depending on model)

Operating the appliance

Preparing the washing machine

Note: The washing machine **must be correctly installed** and **connected** (from → *Page 29*).

1. Connect the mains plug.
2. Turn on the water tap.
3. Open the washing machine door.
4. Check that the drum is completely drained. Drain if necessary.

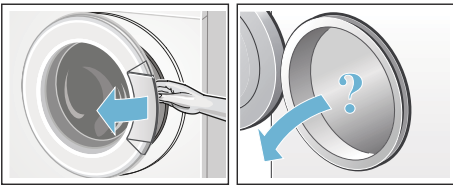

Select programme/switch on the appliance

Use the programme selector to select the required programme. Can be rotated in both directions.

The machine is switched on.

Change the programme default settings

You can use the default settings or change them.

To do this, repeatedly press the corresponding button until the required setting is displayed.

Note: All buttons are sensitive and only need to be touched lightly. If the buttons are held for longer, the appliance automatically runs through the setting options.

The settings are activated without needing to be confirmed.

They are not saved when the appliance is switched off.

Programme default settings
→ *Page 14*

Overview of programmes from
→ *Page 12*

Select additional programme settings

By selecting additional settings, you can better adapt the washing process to your items of laundry.

The settings can be selected or deselected depending on the programme progress.

The indicator lamp for the button lights up if a setting is active.

The settings are not saved when the appliance is switched off.

Additional settings → *Page 14*

Overview of programmes from
→ *Page 12*

Placing laundry into the drum

Warning **Risk of death!!**

Items of laundry pretreated with cleaning agents that contain solvents, e.g. stain remover/cleaning solvent, may cause an explosion after being loaded into the washing machine. Hand-rinse these items of laundry thoroughly beforehand.

Notes

- Mix items of washing of varying sizes. Laundry items of different sizes distribute themselves better during the spin cycle. Individual laundry items may cause an unbalanced load.

en Operating the appliance

- Observe the maximum specified load. Overfilling adversely affects the washing result and promotes creasing.
- 1. Unfold presorted laundry items and place them in the drum.
- 2. Make sure that no items of laundry are trapped between the door and the rubber seal, and close the door.



The indicator light for the Start/Pause button flashes. It is possible to change the settings.

Measure and add detergent and care products

Caution!

Damage to the appliance

Cleaning agents and agents for pretreating laundry (e.g. stain removers, prewash sprays, etc.) may cause damage if they come into contact with the surfaces of the washing machine. Do not allow these agents to come into contact with the surfaces of the washing machine. If necessary, immediately wipe away spray residue and other residues/droplets with a damp cloth.

Measuring

Measure the detergent and care products according to:

- Water hardness (ask your water supply company)
- The manufacturer's instructions on the packaging
- The amount of laundry
- Soiling → Page 11

Filling

Warning **Eye/skin irritation!**

Detergent and care products may spray out if the detergent drawer is opened while the machine is in operation. Open the drawer carefully. Rinse eyes or skin thoroughly if they come into contact with detergent/care products. If swallowed accidentally, seek medical advice.

Note: Dilute viscous fabric softener and fabric conditioner with water; this prevents blockages.

Pour the detergent and care products into the appropriate compartments:

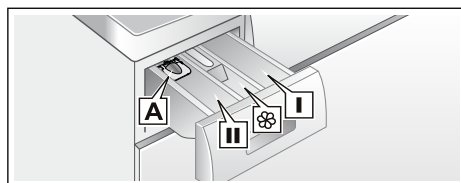

- | | |
|--|--|
| Measuring aid A | For liquid detergent |
| Compartment II | Detergent for the main wash, water softener, bleach, stain remover |
| Compartment  | Softener, starch.
Do not exceed the maximum |
| Compartment I | Detergent for prewash |

1. Pull out the detergent drawer as far as possible.
2. Add detergent and/or care products.
3. Close the detergent drawer.

Measuring aid* for liquid detergent

*Depending on the model

Position the measuring aid for measuring the correct amount of liquid detergent:

1. Pull out the detergent drawer. Press down the insert and fully remove the drawer.
2. Slide the measuring aid forwards, fold it down and click it into place.
3. Reinsert the drawer.

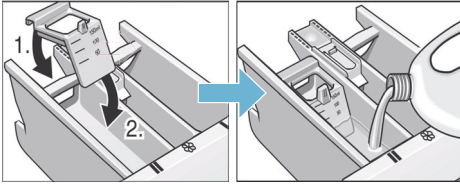

Note: Do not use the measuring aid for gel detergents and washing powder, or for programmes with prewash or when the "Finished in" time is selected.

For models without a measuring aid, pour the liquid detergent into the appropriate dispenser and place it in the drum.

Start the programme

Select the **Start/Pause** button. The indicator light lights up and the programme starts.

Adding laundry

After starting the programme, you can add or remove laundry as required.

To do this, press the **Start/Pause** button.

Note: Do not leave the washing machine door open for too long when adding laundry as water from the laundry may leak out.

For safety reasons, the washing machine door remains locked when the water level or temperature is high, or while the drum is rotating, and it is not possible to add laundry.

To continue the programme, press the **Start/Pause** button. The programme continues automatically.

Changing the programme

If you have started the wrong programme by mistake, you can change the programme as follows:

1. Select another programme.
2. Select **Start/Pause**. The new programme starts from the beginning.

Cancel the programme

For programmes at high temperature:

1. To cool the laundry, select **Rinse/Spin**.
2. Select **Start/Pause**.

For programmes at low temperatures:

1. Select **Start/Pause**.
2. Select **Rinse/Spin** (deactivate the **Rinse plus/Aqua plus** button) or select **Drain**.
3. Select **Start/Pause**.

Programme end during rinse hold

The **Rinse Stop** and  **Rinse** indicator lights light up and the indicator lamp for the **Start/Pause** button flashes.

To end the programme, set the programme selector to "Drain" or select a spin speed. Then select the **Start/Pause** button.

Programme end

The → **Ready** indicator light lights up and the indicator light for the Start/ Pause button flashes.

If the indicator light  also flashes, the washing machine has detected too much foam during the wash programme and automatically switches on a rinse cycle to remove the foam.

Note: Add less detergent to the next washing cycle with the same load.

Removing laundry/switching off the appliance

1. Open the washing machine door and remove the laundry.
2. Turn the programme selector to **Off**. Appliance is switched off.
3. Turn off the water tap.

Note: Not required for Aqua-Stop models.

Notes

- Do not leave any items of laundry in the drum. They may shrink in the next wash or discolour another item.
- Remove any foreign objects from the drum and the rubber seal – risk of rusting.

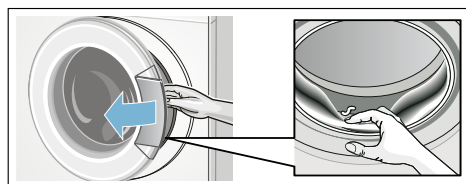

- Leave the washing machine door and detergent drawer open so that any residual water can dry away.

Sensors

Automatic load sensing

The automatic load sensing function adapts the water consumption ideally to each programme depending on the type of fabric and the load.

Unbalanced load detection system

The automatic unbalanced load detection system detects imbalances and ensures even distribution of the laundry by repeatedly starting and stopping drum spinning.

If the laundry is extremely unevenly distributed, the speed is reduced or the spin cycle is not performed for safety reasons.

Note: Place large and small items of laundry in the drum (from → *Page 24*).

Setting the signal

1. Activate setting mode for the signal volume

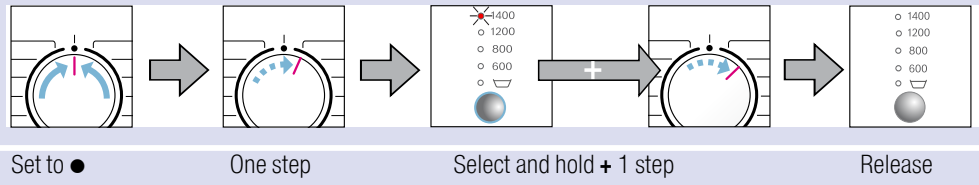

2. Optional: Blind mode* ON-OFF

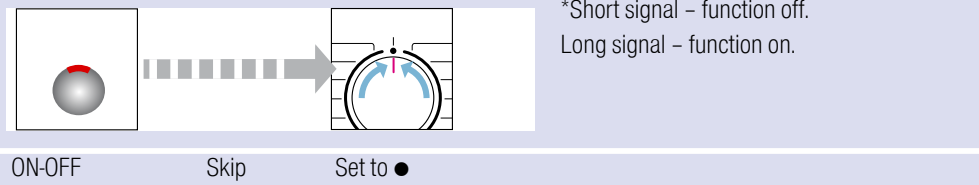

3. Set the volume for the button signals and information signals (depending on the model)

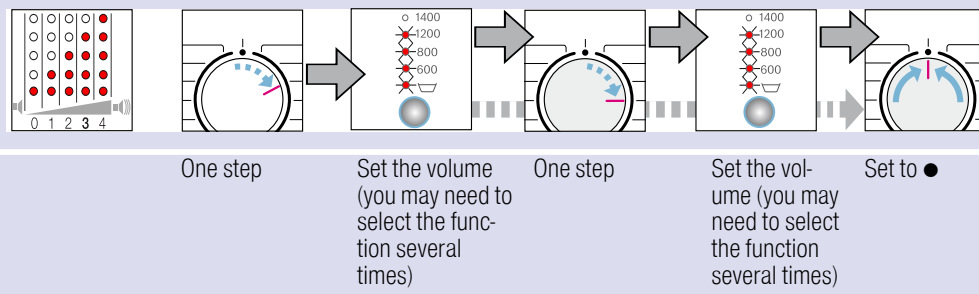



Cleaning and maintenance



Warning **Risk of death!**

There is a risk of electric shock if you touch live components. Switch off the appliance and unplug the mains plug.



Warning **Risk of poisoning!**

Toxic vapours can be produced by cleaning agents that contain solvents, e.g. cleaning solvent. Do not use cleaning agents that contain solvents.

Caution!

Damage to the appliance

Cleaning agents that contain solvents, e.g. cleaning solvent, can damage surfaces and components in the machine. Do not use cleaning agents that contain solvents.

Machine housing/control panel

- Wipe the housing and the control panel with a soft, damp cloth.
- Do not use any abrasive cloths, scourers or cleaning agents (stainless steel cleaners).
- Remove the detergent residue immediately.
- Cleaning with a jet of water is prohibited.

Drum

Wipe the inside of the rubber seal dry with a cloth. Leave the washing machine door open in order that the drum can dry. Use chlorine-free cleaning agents and not steel wool.

Descaling

Note: Make sure that there is no laundry in the machine.

Descaling should not be necessary if the detergent is measured out correctly. However, if it is required, follow the manufacturer's instructions for the descaling agent. Suitable descalers can be obtained via our website or from our after-sales service.

Detergent drawer and housing

If the washing machine contains detergent or fabric softener residues:

1. Pull out the detergent drawer. Press down the insert and fully remove the drawer from the housing.
2. To remove the insert, push the insert up from below with your finger.

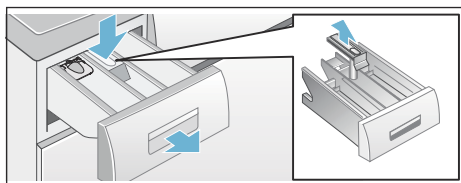

3. Clean the detergent dispenser tray and insert with water and a brush, and dry it. Also remove any detergent or fabric softener residues in the housing.
4. Fit the insert and lock it in place (push the cylinder onto the guide pin).
5. Push in the detergent drawer.

Note: Leave the detergent drawer open so that any residual water can evaporate.

Detergent solution pump blocked

⚠ Warning
Risk of scalding!

When you wash at high temperatures, the detergent solution gets very hot. If you come into contact with the hot detergent solution, you may be scalded. Allow the detergent solution to cool down.

1. Turn off the water tap so that no more water can flow in and has to be drained via the detergent solution pump.
2. Switch off the appliance. Pull out the mains plug.
3. Open and remove the service flap.

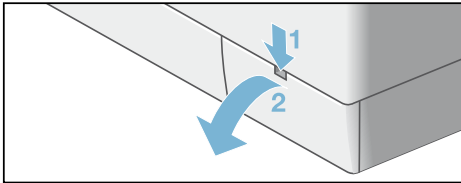

4. **For models with a drain hose:**
Take the drain hose out of the retainer.
Remove the sealing cap; allow the detergent solution to flow out into a suitable container.
Replace the sealing cap and place the drain hose in the retainer.

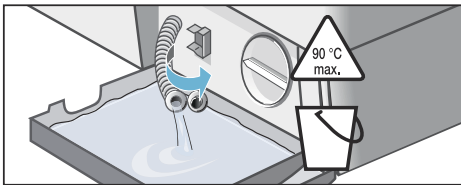

5. **For models without a drain hose:**
Carefully unscrew the pump cover until the detergent solution begins to flow out.
When the service flap is half full, close the pump cover and drain the service flap.

Repeat the above steps until all the detergent solution has completely drained out.

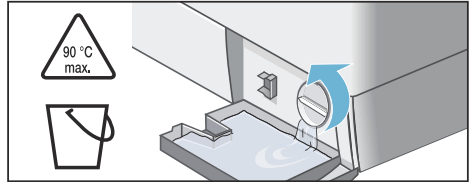

6. Carefully unscrew the pump cover; residual water may leak out. Clean the interior, pump cover thread and pump housing. The impeller in the detergent solution pump must be able to rotate. Refit the pump cover and screw it on tightly. The handle must be in a vertical position.

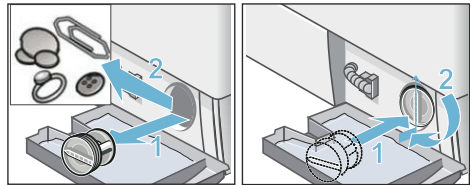

7. Place the service flap back on, lock it into place, and close it.

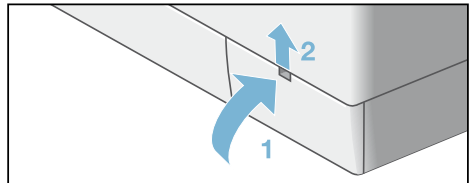

Note: To prevent unused detergent from flowing straight into the drain during the next wash: Pour 1 litre of water into compartment II and start the **Drain** programme.

The drain hose at the siphon is blocked

1. Switch off the appliance. Pull out the mains plug.
2. Loosen the hose clamp. Carefully remove the drain hose, residual water may leak out.
3. Clean the drain hose and siphon connecting piece.

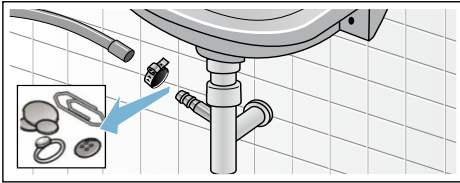

4. Reattach the drain hose and secure the connection point using the hose clamp.

Filter in the water supply blocked



Warning **Risk of electric shock!**

Do not immerse the Aqua-Stop safety valve in water (it contains an electric valve).

First, reduce the water pressure in the supply hose:

1. Turn off the tap.
2. Select any programme (except Rinse/Spin/Drain).
3. Select **Start**/Pause. Allow the programme to run for approximately 40 seconds.
4. Turn the programme selector to **Off**. Pull out the mains plug.
5. Clean the filter on the tap:
Disconnect the hose from the tap.
Clean the filter with a small brush.

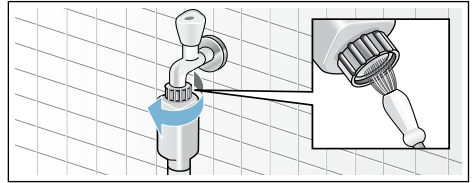

6. For standard and Aqua-Secure models, clean the filter on the rear of the appliance:
Remove the hose from the rear of the appliance.
Use pliers to remove the filter and then clean it.

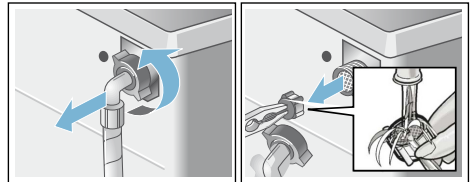

7. Connect the hose and check for leaks.

Faults and what to do about them.

Emergency release

E.g. in the event of a power cut

The programme will continue running when the power supply has been restored.

However, if the laundry has to be removed, the washing machine door can be opened as follows:

Warning

Risk of scalding!

When you are washing at high temperatures, there is a risk of scalding if you come into contact with hot detergent solution and laundry. If possible, leave it to cool down.

Warning

Risk of injury!

You may injure your hands if you reach into the drum while it is rotating. Do not reach into the drum while it is rotating. Wait until the drum has stopped rotating.

Caution!

Water damage





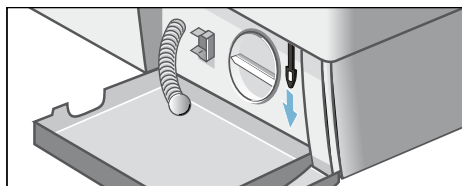









Any escaping water may cause water damage. Do not open the washing machine door if water can be seen through the glass.

1. Switch off the appliance. Pull out the mains plug.
2. Drain off the detergent solution
→ Page 21
3. Use a tool to pull the emergency release downwards and release it. The washing machine door can then be opened.





en Faults and what to do about them.

Information about the indicator lights

Display*	Cause/Remedy	Display*	Cause/Remedy
 1400 ○ 1200 ○ 800 ○ 600 ○ 	Close the washing machine door properly; washing may be trapped.	 1400 ○ 1200  800 ○ 600 	Motor fault. Call the after-sales service.
 1400 ○ 1200 ○ 800  600 ○ 	Drain pump blocked; clean the drain pump → <i>Page 21</i> Drain hose/outlet pipe blocked; clean drain hose on the siphon → <i>Page 22</i>	 1400 ○ 1200  800  600 	There is water in the base trough*, the appliance is leaking. Call the after-sales service.
 1400 ○ 1200 ○ 800 ○ 600 	Turn on the tap fully, supply hose kinked/jammed: Clean the filter → <i>Page 22</i> , water pressure too low.		* Depending on the model

Faults and what to do about them.

Faults	Cause/Remedy
Water is leaking from the appliance.	<ul style="list-style-type: none"> ■ Attach the drain hose correctly or replace it. ■ Tighten the screw joint on the supply hose.
The appliance is not filling with water.	<ul style="list-style-type: none"> ■ Start/Pause not selected? ■ Is the tap turned on?
Detergent is not being dispensed.	<ul style="list-style-type: none"> ■ Could the filter be clogged? Clean the filter. ■ Is the supply hose kinked or trapped?
The door cannot be opened.	<ul style="list-style-type: none"> ■ The safety function is activated. Wait for approx. 2 minutes. ■  (without final spin) selected? ■ Can be opened by emergency release only?
The programme does not start.	<ul style="list-style-type: none"> ■ Start/Pause selected? ■ Is the door closed?
The water is not draining.	<ul style="list-style-type: none"> ■  (without final spin) selected? ■ Clean the drain pump. ■ Clean the outlet pipe and/or the drain hose.
Water is not visible in the drum.	Not a fault – the water is below the visible area.

Faults	Cause/Remedy
The spin result is not satisfactory. Laundry is wet/too damp.	<ul style="list-style-type: none"> ■ Not a fault – unbalanced load detection system has stopped the spin cycle; washing unevenly distributed. Distribute small and large items of washing in the drum. ■  Easy-Iron selected? ■ Is the selected speed too low?
The spin cycle runs several times.	Not a fault – the unbalanced load detection system is adjusting an imbalance.
The programme is taking longer than usual.	<ul style="list-style-type: none"> ■ Not a fault – the unbalanced load detection system is adjusting an imbalance by repeatedly distributing the laundry. ■ Not a fault; the foam detection system is active – a rinse cycle has been switched on.
Residual water in the care product dispenser.	<ul style="list-style-type: none"> ■ Not a fault – the effect of the care product is not affected. ■ Clean the insert if necessary
Odours in the washing machine.	Run the Cottons 90 °C programme without laundry. Use standard detergent for this.
Wash indicator light flashes. Foam may also be leaking from the detergent drawer.	Have you used too much detergent? Mix one tablespoon of fabric softener with 1/2 litre of water and pour into compartment II (not for outdoor fabrics or those made with down). Use less detergent in the next washing cycle.
Loud noises, vibrations and machine "movement" during the spin cycle.	<ul style="list-style-type: none"> ■ Are the appliance's feet fixed? Secure the appliance's feet. ■ Have the transport locks been removed? Remove the transport locks.
Noises during spin and drain cycles.	Clean the drain pump
The indicator lights do not work while the appliance is running.	<ul style="list-style-type: none"> ■ Has there been a power failure? ■ Have the fuses blown? Reset/replace the fuses. ■ If the fault occurs repeatedly, call the after-sales service.
There is detergent residue on the laundry.	<ul style="list-style-type: none"> ■ Some phosphate-free detergents contain water-insoluble residue. ■ Select Rinse/Spin or brush the laundry after washing.
If you cannot rectify a fault yourself (after switching the machine off and on again) or a repair is required: <ul style="list-style-type: none"> ■ Turn the programme selector to Off. The appliance is switched off. ■ Unplug the mains plug from the socket. ■ Turn off the tap and call the after-sales service. 	

After-sales service

If you cannot rectify a fault yourself (Faults and what to do about them → *Page 24*), please contact our after-sales service. → Cover page

We will always find an appropriate solution in order to avoid unnecessary visits by engineers.

Please give the after-sales service the product number (E-Nr.) and the production number (FD) of the appliance.

E-Nr. _____ FD _____	
Product number	Production number

You can find this information (*depending on the model):

On the inside of the washing machine door*/in the opened service flap* and on the rear of the appliance.

Trust the expertise of the manufacturer.

Contact us for assistance. By doing so, you will ensure that the repairs are carried out by trained service personnel using genuine spare parts.



Consumption rates

Energy and water consumption, programme duration and residual moisture for the main washing programmes

Programme	Load	Energy consumption*	Water*	Programme duration*
Cottons 20 °C	7 kg	0,31 kWh	72 l	2 ¾ h
Cottons 40 °C	7 kg	0,85 kWh	72 l	2 ¾ h
Cottons 60 °C	7 kg	1,21 kWh	72 l	2 ¾ h
Cottons 90 °C	7 kg	2,01 kWh	77 l	3 h
Easy-Care 40 °C	3 kg	0,64 kWh	56 l	1 ¾ h
Mixed Load 40 °C	3 kg	0,46 kWh	36 l	1 ¼ h
Delicate/Silk 30 °C	2 kg	0,24 kWh	37 l	¾ h
 / Wool 30 °C	2 kg	0,22 kWh	47 l	¾ h







Programme	Approximate information on the residual moisture**			
	WAE28 ...	WAE24. ..	WAE20 ...	WAE16 ...
	max 1400 U/min	max 1200 U/min	max 1000 U/min	max 800 U/min
Cottons	53 %	58 %	68 %	80 %
Easy-Care	40 %	40 %	40 %	40 %
Delicate/Silk	30 %	30 %	30 %	30 %
Wool	45 %	45 %	45 %	45 %

* The values may deviate from the stated values depending on the following factors: water pressure and hardness; water inlet temperature; ambient temperature; type, amount and soiling of laundry; type of detergent used; fluctuations in the power supply and additional functions selected.

** Information on residual moisture based on programme-dependent spin speed limits and maximum loads.

Efficiency test programmes for cotton fabrics

The following programmes (standard programmes, indicated by ) are suitable for cleaning normally soiled cotton fabrics and are the most efficient with respect to combined energy and water consumption.

Standard programmes for Cottons in accordance with regulation (EU) no. 1015/2010	Load	Approximate programme duration
Cottons programme  + button  Eco	7 kg	3 ¾ h
Cottons programme  + button  Eco	3,5 kg	3 ¾ h
Cottons programme  + button  Eco	3,5 kg	3 ¼ h

Programme setting for testing and energy labelling in accordance with Directive 2010/30/EU with cold water (15 °C).
The specification of the programme temperature is based on the temperature stated on the care label in the textiles. The actual washing temperature may deviate from the stated programme temperature for energy-saving reasons.



Technical data

Dimensions:

850 x 600 x 590 mm

(height x width x depth)

Weight:

68 - 75 kg (depending on the model)

Mains connection:

Mains voltage 220-240 V, 50 Hz

Nominal current 10 A

Nominal power 2000-2300 W

Water pressure:

100 - 1000 kPa (1 - 10 bar)

Power consumption when switched off:

0.20 W

Power consumption when ready for use (left-on mode):

1.90 W

Positioning and connecting

Included with the appliance

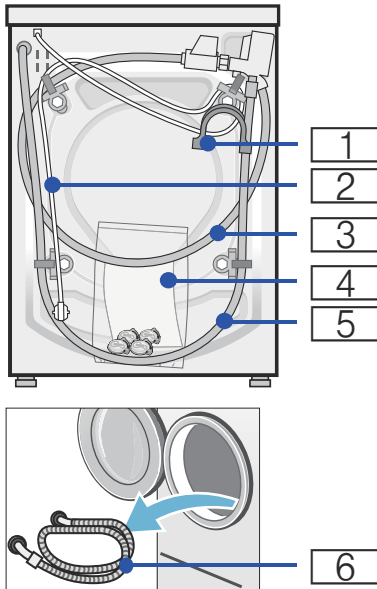

- 1 Elbow for securing the water drain hose*
- 2 Mains cable
- 3 Water supply hose on Aqua-Stop models
- 4 Bag*:
 - Installation and operating instructions
 - After-sales service location directory*
 - Warranty*
 - Cover caps for openings left after removing the transport locks
 - Spanner*
- 5 Water drain hose
- 6 Water supply hose on standard/Aqua-Secure models

* depending on the model

Notes

- Check the machine for transport damage. Never use a damaged machine. If you have a complaint, please contact the retailer from whom you purchased the appliance, or our after-sales service.
- Moisture in the drum is due to the final inspection.

In addition, a hose clamp (24-40 mm diameter, available from specialist dealers) is required to connect the water drain hose to a siphon.

Useful tools

- Spirit level for levelling
- Spanner with:
 - WAF 13 for loosening the transport locks, and
 - WAF 17 for aligning the appliance feet

Safety instructions

Warning Risk of injury!

- The washing machine is very heavy. Be careful when lifting/transporting the washing machine.
- If the washing machine is lifted by protruding components (e.g. the washing machine door), the components may break off and cause injuries. Do not lift the washing machine by protruding parts.
- If the hose and mains cables are not routed properly, there is a risk of tripping and injury. Lay hoses and cables in such a way that there is no risk of tripping.

Caution! Damage to the appliance

Frozen hoses may crack/burst. Do not install the washing machine in areas exposed to frost and/or outdoors.

Caution!

Water damage

The connection points for the water supply hose and water drain hose are under high water pressure. To prevent leaks and water damage, you must follow the instructions in this section.

Notes

- In addition to the safety information listed here, the local water and electricity supplier may have special requirements.
- If in doubt, have the appliance connected by a specialist.

Installation surface

Note: The washing machine must be stable so that it does not move around.

- The surface on which it is installed must be firm and level.
- Soft floors/floor coverings are not suitable.

Installation on a base or a wooden joist floor

Caution!

Damage to the appliance

The washing machine may "wander" and tip/topple from the base when spinning.

Use holding brackets to secure the feet of the appliance.

Order no. WMZ2200, WX975600, Z7080X0

Note: On wooden joist floors, install the washing machine:

- In a corner, if possible,
- On a water-resistant wooden board (min. 30 mm thick) which is screwed tightly to the floor.

Installing the appliance in a kitchenette

Warning

Install the appliance (underneath the worktop or fitted in a cabinet) before connecting it to the power supply.

Notes

- Recess width of 60 cm required.
- Only install the washing machine underneath a continuous worktop that is securely connected to adjacent cabinets.

Warning

Risk of electric shock!

Instead of the appliance covering plate, you **must** have a metal cover* fitted by an expert.

* Order no. WMZ2420, WZ10190

Removing the transport locks

Caution!

Damage to the appliance

- The machine is secured for transportation using transport locks. If the transport locks are not removed, the drum, for example, may become damaged when the machine is operated. Before using the appliance for the first time, make sure that you completely remove all four transport locks. Keep the locks in a safe place.
- To prevent transport damage from occurring if the appliance is moved at a later date, you must refit the transport locks before transporting the appliance.

Note: Store the screw and sleeve screwed together.

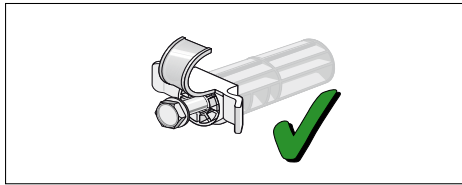

1. Take the hoses out of the holders.

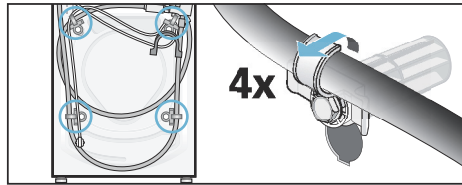

2. Unscrew and remove all four transport brace screws. Remove the sleeves. To do this, remove the mains cable from the holders.

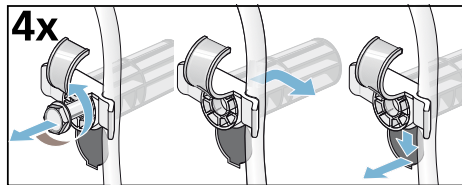

3. Fit the covers. Lock the covers firmly in place by applying pressure to the snap-in hooks.

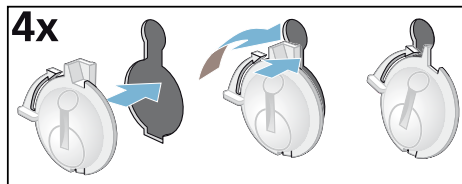

Hose and cable lengths

■ Left-hand connection

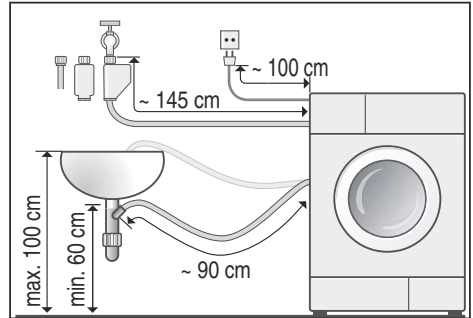

■ Right-hand connection

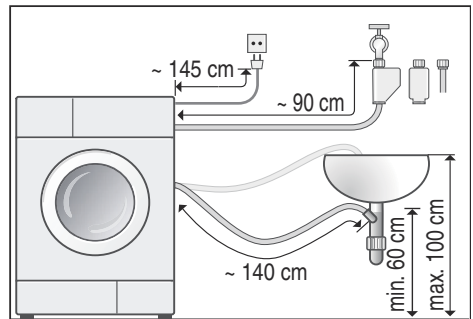

Tip:

The following are available from specialist dealers/the after-sales service:

- Extension for Aqua-Stop and cold water supply hose (approx. 2.50 m). Order no. WMZ2380, WZ10130, Z7070X0
- A longer supply hose (approx. 2.20 m) for standard model

Water inlet

Warning **Risk of death!**

There is a risk of electric shock if you touch live components. Do not immerse the Aqua-Stop safety valve in water (it contains an electric valve).

Observe the following when connecting the machine:

Notes

- Only operate the washing machine using cold mains water.
- Do not connect the machine to the mixer tap of an unpressurised hot-water boiler.
- Do not use a used supply hose. Only use the supply hose supplied or one that was purchased from an authorised specialist retailer.
- Do not bend, squash, modify or cut through the water supply hose (otherwise its strength is no longer guaranteed).
- Only tighten the screw connections by hand. If the screw connections are tightened too much with a tool (pliers), the thread may be damaged.

Optimum water pressure in the supply network

At least 100 kPa (1 bar)

Maximum 1000 kPa (10 bar)

When the tap is open, the water flow is at least 8 l/min.

If the water pressure is higher than this, a pressure-reducing valve must be installed.

Connection

Connect the water supply hose to the water tap ($\frac{3}{4}$ " = 26.4 mm) and to the appliance (not necessary for Aqua-Stop models as this is permanently installed):

■ Model: **Standard**

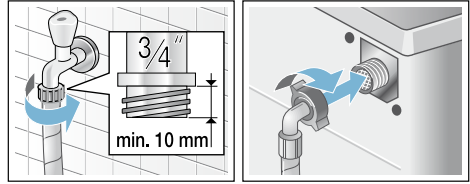

■ Model: **Aqua-Secure**

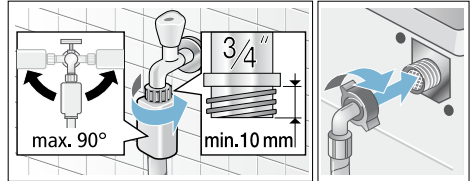

■ Model: **Aqua-Stop**

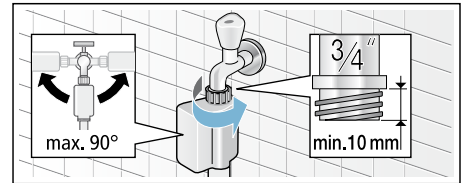

Note: Open the water tap carefully, checking the leak tightness of the connection points. The screw connection is under mains water pressure.

Water outlet

Caution! Water damage

If the drain hose slips out of the wash basin or the connection point during draining due to high water pressure, any escaping water may cause water damage.

Secure the drain hose so that it cannot slip out.

Notes

- Do not kink the water drain hose or put strain on it lengthways.
- Height difference between the installation surface and the drain:
Min. 60 cm, max. 100 cm

You can lay the water drain hose as follows:

■ Drainage into a washbasin

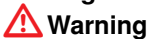

Warning

Risk of scalding!

When you are washing at high temperatures, there is a risk of scalding if you come into contact with hot detergent solution (e.g. when draining hot detergent solution into a washbasin).

Do not reach into the hot detergent solution.

Caution!

Damage to the appliance/fabrics

If the end of the drain hose is immersed in the drained water, water may be sucked back into the appliance and may damage the appliance/fabrics.

Make sure that:

- The plug does not block drainage from the washbasin.
- The end of the drain hose is not immersed in the drained water.
- The water drains away quickly enough.

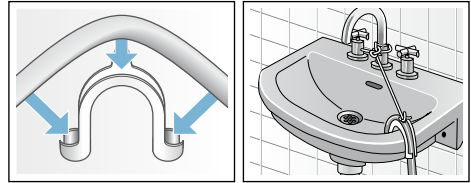

■ Drainage into a siphon

The connection point must be secured using a hose clamp with a diameter of 24-40 mm (available from specialist dealers).

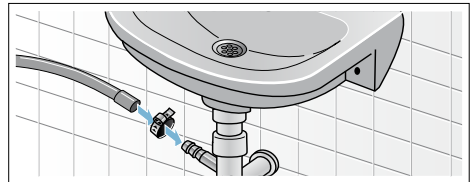

Levelling

Level the appliance using a spirit level. Incorrect levelling may result in intense noise, vibrations and "wandering".

1. Loosen the lock nuts using a spanner, by turning it in a clockwise direction.
2. Check the levelling of the washing machine with a spirit level, and adjust it if necessary. Change the height by turning the appliance feet. All four appliance feet must stand firmly on the ground.
3. Tighten the lock nut against the housing.
In doing so, hold the foot tight and do not adjust its height. The lock nuts on all four appliance feet must be screwed tightly against the housing.

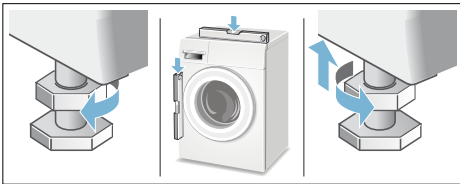

Electrical connection

Warning **Risk of death!**

There is a risk of electric shock if you touch live components.

- Never touch or hold the mains plug with wet hands.
- Only pull out the mains cable by the plug and never by the cable, as this could damage it.
- Never unplug the mains plug during operation.

Observe the following information and ensure that:

Notes

- The mains voltage and voltage indicated on the washing machine (rating plate) are the same. The connected load and fuse required are specified on the rating plate.
- The washing machine is only connected to an alternating current via a properly installed earthed socket.
- The mains plug fits the socket.
- The cable cross-section is adequate.
- The earthing system is properly installed.
- The mains cable is only replaced by a qualified electrician (if this is necessary). Replacement mains cables are available from the after-sales service.
- No multiple plugs/couplings or extension cables are used.
- If an earth-leakage circuit breaker is used, only a type which displays this symbol  is used. Only this symbol guarantees compliance with the currently applicable regulations.
- The mains plug can be accessed at all times.
- The mains cable is not bent, squashed, modified, cut through, or in contact with heat sources.

Before washing for the first time

The washing machine was thoroughly tested before leaving the factory. To remove any water that may be left over from the test, run the first wash cycle **without** any laundry.

Notes

- The washing machine **must be correctly installed and connected.** (from → *Page 29*).
 - Never use a damaged machine. Inform the after-sales service.
1. Check the machine.
 2. Remove the protective film from the control panel.
 3. Connect the mains plug.
 4. Turn on the tap.
 5. Close the door (do not load any laundry).
 6. Select the **Cottons 90 °C** programme.
 7. Open the detergent drawer.
 8. Pour approximately 1 litre of water into compartment **II**.
 9. Pour standard detergent into compartment **II**.

Note: To prevent foaming, only use half of the amount of detergent recommended by the detergent manufacturer. Do not use detergents designed for woollens or delicates.
 10. Close the detergent drawer.
 11. Select **Start/Pause**.
 12. Switch off the appliance at the end of the programme.

Your washing machine is now ready to use.

Transportation

E.g. when moving house

Preparatory work:

1. Turn off the water tap.
2. Reduce the water pressure in the supply hose.
Maintenance – filter in the water supply → *Page 22*
3. Drain the remaining detergent solution.
Maintenance – detergent solution pump blocked → *Page 21*
4. Disconnect the washing machine from the mains.
5. Remove the hoses.

Installing the transport locks:

1. Remove the covers and keep them in a safe place.
Use a screwdriver if necessary.
2. Insert all 4 sleeves.
Clip the mains cable securely in the holders. Insert and tighten the screws.

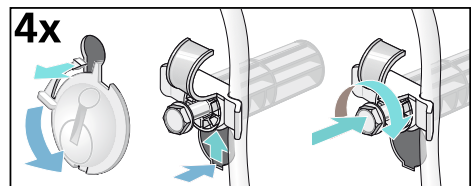

Before commissioning:

Notes

- The transport locks **must** be removed.
- To prevent unused detergent from flowing straight into the drain during the next wash: Pour approx. 1 litre of water into compartment **II** and start the **Drain** programme.

Aqua-Stop warranty

Only for appliances with Aqua-Stop

In addition to warranty claims against the vendor based on the purchase agreement and to our appliance warranty, we will provide compensation under the following conditions:

1. If water damage is caused due to a fault in our Aqua-Stop system, we will compensate domestic customers for the damage caused.
2. The liability guarantee is valid for the service life of the appliance.
3. It is a prerequisite of all warranty claims that the appliance with Aqua-Stop must have been installed and connected correctly in accordance with our instructions; this also includes a correctly fitted Aqua-Stop extension (genuine accessories).

Our warranty does not cover defective feed lines or fittings leading to the Aqua-Stop connection at the tap.

4. Appliances with Aqua-Stop do not need to be supervised during operation, nor secured afterwards by turning off the tap.
The tap only needs to be turned off if you are away from home for a long period, e.g. for several weeks' holiday.



Advice and repair order in the event of faults

GB 0344 892 8979 (Calls charged at local or mobile rate.)

IE 01450 2655 (0.03 € per minute at peak. Off peak 0.0088 € per minute.)

You can find the contact information for all countries in the attached after-sales service directory.

Robert Bosch, Hausgeräte GmbH
Carl-Wery-Straße 34
81739 München
DEUTSCHLAND



9001021195 (9407)