



Register your new Bosch now:
www.bosch-home.com/welcome













Extractor hood



BOSCH

en Instructions for installation
and use

Table of contents

INSTRUCTION MANUAL	2
 Intended use	2
 Important safety information	2
 Environmental protection	4
 Operating modes	4
 Operating the appliance	5
 Cleaning and maintenance	8
 Trouble shooting	9
 Customer service	10
INSTALLATION INSTRUCTIONS	11
 Important safety information	11
 General information	13
 Installation	14

INSTRUCTION MANUAL

Additional information on products, accessories, replacement parts and services can be found at www.bosch-home.com and in the online shop www.bosch-eshop.com

Intended use

Read these instructions carefully. Only then will you be able to operate your appliance safely and correctly. Retain the instruction manual and installation instructions for future use or for subsequent owners.

The appliance can only be used safely if it is correctly installed according to the safety instructions. The installer is responsible for ensuring that the appliance works perfectly at its installation location.

This appliance is intended for domestic use and the household environment only. The appliance is not intended for use outside. Do not leave the appliance unattended during operation. The manufacturer is not liable for damage which is caused by improper use or incorrect operation.

This appliance may be used by children over the age of 8 years old and by persons with reduced physical, sensory or mental capabilities or by persons with a lack of experience or knowledge if they are supervised or are instructed by a person responsible for their safety how to use the appliance safely and have understood the associated hazards.

Children must not play with, on, or around the appliance. Children must not clean the appliance or carry out general maintenance unless they are at least 8 years old and are being supervised.

Keep children below the age of 8 years old at a safe distance from the appliance and power cable.

Check the appliance for damage after unpacking it. Do not connect the appliance if it has been damaged in transport.

This appliance is not intended for operation with an external clock timer or a remote control.

Important safety information

Warning

Danger of suffocation!

Packaging material is dangerous to children. Never allow children to play with packaging material.

Warning

Danger of death!

Risk of poisoning from flue gases that are drawn back in.

Always ensure adequate fresh air in the room if the appliance is being operated in exhaust air mode at the same time as room air-dependent heat-producing appliance is being operated.

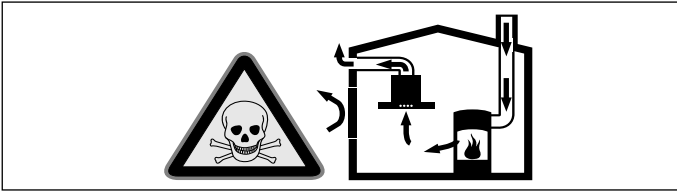

Room air-dependent heat-producing appliances (e.g. gas, oil, wood or coal-operated heaters, continuous flow heaters or water heaters) obtain combustion air from the room in which they are installed and discharge the exhaust gases into the open air through an exhaust gas system (e.g. a chimney).

In combination with an activated vapour extractor hood, room air is extracted from the kitchen and neighbouring rooms - a partial vacuum is produced if not enough fresh air is supplied. Toxic gases from the chimney or the extraction shaft are sucked back into the living space.

- Adequate incoming air must therefore always be ensured.
- An incoming/exhaust air wall box alone will not ensure compliance with the limit.

Safe operation is possible only when the partial vacuum in the place where the heat-producing appliance is installed does not exceed 4 Pa (0.04 mbar). This can be achieved when the air needed for combustion is able to enter through openings that cannot be sealed, for example in doors, windows, incoming/exhaust air wall boxes or by other technical means.

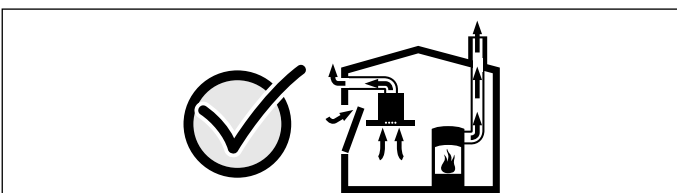

In any case, consult your responsible Master Chimney Sweep. He is able to assess the house's entire ventilation setup and will suggest the suitable ventilation measures to you.

Unrestricted operation is possible if the vapour extractor hood is operated exclusively in the circulating-air mode.

⚠ Warning **Risk of fire!**

- Grease deposits in the grease filter may catch fire.
Clean the grease filter at least every 2 months.
Never operate the appliance without the grease filter.
- Grease deposits in the grease filter may catch fire. Never work with naked flames close to the appliance (e.g. flambéing). Do not install the appliance near a heat-producing appliance for solid fuel (e.g. wood or coal) unless a closed, non-removable cover is available. There must be no flying sparks.
- Hot oil and fat can ignite very quickly. Never leave hot fat or oil unattended. Never use water to put out burning oil or fat. Switch off the hotplate. Extinguish flames carefully using a lid, fire blanket or something similar.
- When gas burners are in operation without any cookware placed on them, they can build up a lot of heat. A ventilation appliance installed above the cooker may become damaged or catch fire. Only operate the gas burners with cookware on them.
- Operating several gas burners at the same time gives rise to a great deal of heat. A ventilation appliance installed above the cooker may become damaged or catch fire. Never operate two gas burners simultaneously on the highest flame for longer than 15 minutes. One large burner of more than 5 kW (wok) is equivalent to the power of two gas burners.

⚠ Warning **Risk of burns!**

The accessible parts become very hot when in operation. Never touch hot parts. Keep children at a safe distance.

⚠ Warning **Risk of injury!**

- Components inside the appliance may have sharp edges. Wear protective gloves.
- Items placed on the appliance may fall down. Do not place any objects on the appliance.
- The light emitted by LED lights is very dazzling, and can damage the eyes (risk group 1). Do not look directly into the switched on LED lights for longer than 100 seconds.

Warning

Risk of electric shock!

- A defective appliance may cause electric shock. Never switch on a defective appliance. Unplug the appliance from the mains or switch off the circuit breaker in the fuse box. Contact the after-sales service.
- Incorrect repairs are dangerous. Repairs may only be carried out and damaged power cables replaced by one of our trained after-sales technicians. If the appliance is defective, unplug the appliance from the mains or switch off the circuit breaker in the fuse box. Contact the after-sales service.
- Do not use any high-pressure cleaners or steam cleaners, which can result in an electric shock.

Causes of damage

Caution!

Risk of damage due to corrosion. Always switch on the appliance while cooking to avoid condensation. Condensate can produce corrosion damage.

Always replace faulty bulbs to prevent the remaining bulbs from overloading.

Risk of damage due to ingress of humidity into the electronic circuitry. Never clean operator controls with a wet cloth.

Surface damage due to incorrect cleaning. Clean stainless steel surfaces in the direction of the grain only. Do not use any stainless steel cleaners for operator controls.

Surface damage due to strong or abrasive cleaning agents. Never use strong and abrasive cleaning agents.

Risk of damage from returning condensate. Install the exhaust duct in such a way that it falls away from the appliance slightly (1° slope).

Environmental protection

Environmentally-friendly disposal

Dispose of packaging in an environmentally-friendly manner.



This appliance is labelled in accordance with European Directive 2012/19/EU concerning used electrical and electronic appliances (waste electrical and electronic equipment - WEEE). The guideline determines the framework for the return and recycling of used appliances as applicable throughout the EU.

Operating modes

Exhaust air mode



The air which is drawn in is cleaned by the grease filters and conveyed to the exterior by a pipe system.

Note: The exhaust air must not be conveyed into a functioning smoke or exhaust gas flue or into a shaft which is used to ventilate installation rooms which contain heat-producing appliances.

- Before conveying the exhaust air into a non-functioning smoke or exhaust gas flue, obtain the consent of the heating engineer responsible.
- If the exhaust air is conveyed through the outer wall, a telescopic wall box should be used.

Circulating-air mode



The air which is drawn in is cleaned by the grease filters and an activated carbon filter and conveyed back into the kitchen.

Notes

- To bind odours in circulating-air mode, you must install an activated carbon filter. The different options for operating the appliance in circulating-air mode can be found in the brochure. Alternatively, ask your dealer. The required accessories are available from specialist retailers, from customer service or from the Online Shop.
- For appliances with an additional internal filter, only the CleanAir recirculation module (see Accessories for circulating-air mode) can be used.

Operating the appliance



These instructions apply to several appliance variants. It is possible that individual features are described which do not apply to your appliance.

Note: Switch on the extractor hood when you start cooking and switch it off again several minutes after you have finished cooking. This is the most effective way of removing the kitchen fumes.

Control panel model 1



Control panel



Explanation	
	Fan on/off
-	Reduce the fan settings/fan run-on time
+	Increase the fan settings/intensive setting 1, 2
	Light on/off/dimming

Setting the fan

Switching on the appliance

- Press the  button.
The fan starts at setting .
- Press the + or - button to change the fan strength.



Switching off

- Press the  button.

Intensive setting

You can use the intensive setting if there is a large build-up of odours and fumes/vapours.

Press the + button when the fan is at setting .

The intensive boost setting  is activated. Pressing the + button again activates the intensive boost  setting.

After approx. six minutes, the electronics automatically reduce the fan to a lower setting . If you want to end the intensive setting before the preset time expires, press the - button until the required fan setting is reached.

Fan run-on time

Press the - button until  appears.

After approx. ten minutes, the fan switches off automatically.

Lighting

The lighting can be switched on and off independently of the fan.

Press the  button.

Setting the brightness

Press and hold the  button until the desired brightness is reached.

Saturation display

When the metal mesh grease filters or the activated carbon filter are saturated, a signal sounds for approx. 4 seconds after the fan is switched off.

In addition, the corresponding symbol appears in the display:

- **Metal mesh grease filter:** 
- **Activated carbon filter:** 





If you have not yet done so, the metal mesh grease filters should be cleaned or the activated carbon filter changed now.

For instructions on how to clean the metal mesh grease filters, please refer to the section *Cleaning and maintenance*.

While the saturation displays are flashing, they can be reset. To do this, press the - button.

Switching over the display for circulating-air mode

For circulating-air mode, the electronic control display must be switched over accordingly:

- The extractor hood must be connected and switched off.
- Press the  and - button at the same time until the  display for starter sets for circulating-air mode or  display for CleanAir circulating air modules lights up.
- Repeatedly press the button combination to switch the electronic control display back to exhaust air mode ( display).

Audible signal

Switching on the acoustic signal

When the fan is switched off, press the  and + buttons at the same time for approx. three seconds. An acknowledgement signal sounds.

Switching off the acoustic signal

Repeat the "Switching on the acoustic signal" process.

Control panel model 2

Control panel



Explanation	
	Fan on/off
	Switch off the saturation display
-	Reduce the fan settings
+	Increase the fan settings/intensive setting 1, 2
	Fan run-on time
	Light on/off/dimming

Setting the fan

Switching on the appliance

- Press the button.
The fan starts at setting .
- Press the + or - button to change the fan strength.

Switching off

- Press the button.

Intensive setting

You can use the intensive setting if there is a large build-up of odours and fumes/vapours.

Press the + button when the fan is at setting .

The intensive boost setting is activated. Pressing the + button again activates the intensive boost setting.

After approx. six minutes, the electronics automatically reduce the fan to a lower setting . If you want to end the intensive setting before the preset time expires, press the - button until the required fan setting is reached.

Fan run-on time

The fan run-on time is possible at every fan setting (except boost and boost .

Select the desired fan setting and press the button.

min appears on the display.

Once this time has elapsed, the fan switches off automatically.

Setting the run-on time

When min appears on the display, press the + or - button.

You can set a run-on time of between 1 and 9 minutes.

Lighting

The lighting can be switched on and off independently of the fan.

Press the button.

Setting the brightness

Press and hold the button until the desired brightness is reached.

Saturation display

When the metal mesh grease filters or the activated carbon filter are saturated, a signal sounds for approx. 4 seconds after the fan is switched off.

In addition, the corresponding symbol appears in the display:

- **Metal mesh grease filter:**
- **Activated carbon filter:**

If you have not yet done so, the metal mesh grease filters should be cleaned or the activated carbon filter changed now.

For instructions on how to clean the metal mesh grease filters, please refer to the section *Cleaning and maintenance*.

While the saturation displays are flashing, they can be reset. To do this, press the .

Switching over the display for circulating-air mode

For circulating-air mode, the electronic control display must be switched over accordingly:

- The extractor hood must be connected and switched off.
- Press the and buttons at the same time until the display for starter sets for circulating-air mode or display for CleanAir circulating air modules lights up.
- Repeatedly press the button combination to switch the electronic control display back to exhaust air mode (display).

Audible signal

Switching on the acoustic signal

When the fan is switched off, press the and + buttons at the same time for approx. three seconds. An acknowledgement signal sounds.

Switching off the acoustic signal

Repeat the "Switching on the acoustic signal" process.

Control panel model 3

Control panel

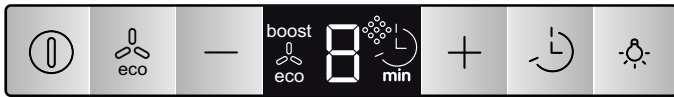

Explanation

	Fan on/off
	Eco function (automatic mode)
-	Reduce the fan settings
+	Increase the fan settings/intensive setting 1, 2
	Fan run-on time
	Light on/off/dimming

Setting the fan

Switching on the appliance

- Press the button.
The fan starts at setting **2**.
- Press the + or - button to change the fan strength.

Switching off

- Press the button.

Intensive setting

You can use the intensive setting if there is a large build-up of odours and fumes/vapours.

Press the + button when the fan is at setting **3**.

The intensive boost setting **!** is activated. Pressing the + button again activates the intensive boost **2** setting.

After approx. six minutes, the electronics automatically reduce the fan to a lower setting **.** If you want to end the intensive setting before the preset time expires, press the - button until the required fan setting is reached.

Automatic mode

Switching on the appliance

- Press the button.
The fan starts at **2** setting.
- Press the button.
The optimum fan setting **1, 2** or **3** is automatically set via a sensor.

Switching off the appliance

Press the or button to switch off automatic mode.

The fan switches off automatically if the sensor no longer detects a change in the air quality of the room.

The automatic mode lasts 4 hours at most.

Sensor control

In automatic mode, a sensor in the extractor hood detects the intensity of the cooking and roasting fumes. Depending on the setting of the sensor, the fan automatically switches to another fan setting.

Default sensitivity setting: **5**

Lowest sensitivity setting: **0**

Highest sensitivity setting: **9**

If the sensor control responds too quickly or too slowly, it can be changed accordingly:

1. When the fan is switched off, press the button and hold it for approx. 4 seconds. The setting is displayed.
2. Press the + or - button to change the setting of the sensor control.
3. To confirm the entries, press and hold the button for approx. 4 seconds.

Fan run-on time

The fan run-on time is possible at every fan setting (except boost **!** and boost **2**).

Select the desired fan setting and press the button.

9 min appears on the display.

Once this time has elapsed, the fan switches off automatically.

Setting the run-on time

When **9 min** appears on the display, press the + or - button.

You can set a run-on time of between 1 and 9 minutes.

Lighting

The lighting can be switched on and off independently of the fan.

Press the button.

Setting the brightness

Press and hold the button until the desired brightness is reached.

Saturation display

When the metal mesh grease filters or the activated carbon filter are saturated, a signal sounds for approx. 4 seconds after the fan is switched off.

In addition, the corresponding symbol appears in the display:

- **Metal mesh grease filter:**
- **Activated carbon filter:**





If you have not yet done so, the metal mesh grease filters should be cleaned or the activated carbon filter changed now.

For instructions on how to clean the metal mesh grease filters, please refer to the section **Cleaning and maintenance**.

While the saturation displays are flashing, they can be reset. To do this, press the - button.

Switching over the display for circulating-air mode

For circulating-air mode, the electronic control display must be switched over accordingly:

- The extractor hood must be connected and switched off.
- Press the  and  buttons at the same time until the  display for starter sets for circulating-air mode or  display for CleanAir circulating air modules lights up.
- Repeatedly press the button combination to switch the electronic control display back to exhaust air mode ( display).

Audible signal

Switching on the acoustic signal

When the fan is switched off, press the  and + buttons at the same time for approx. three seconds. An acknowledgement signal sounds.

Switching off the acoustic signal

Repeat the "Switching on the acoustic signal" process.

Cleaning and maintenance

Warning

Risk of burns!

The appliance will become hot during operation, especially near the bulbs. Allow the appliance to cool down before cleaning.

Warning

Risk of electric shock!

Penetrating moisture may result in an electric shock. Clean the appliance using a damp cloth only. Before cleaning, pull out the mains plug or switch off the circuit breaker in the fuse box.

Warning

Risk of electric shock!

Do not use any high-pressure cleaners or steam cleaners, which can result in an electric shock.

Warning

Risk of injury!

Components inside the appliance may have sharp edges. Wear protective gloves.

Cleaning agents

Observe the information in the table to ensure that the different surfaces are not damaged by using the wrong type of cleaning agent. Do not use

- harsh or abrasive cleaning agents,
- cleaning agents with a high concentration of alcohol,
- hard scouring pads or sponges,
- high-pressure cleaners or steam cleaners.

Wash new sponge cloths thoroughly before use.

Follow all instructions and warnings included with the cleaning agents.

Area	Cleaning agents
Stainless steel	Hot soapy water: Clean with a dish cloth and dry with a soft cloth. Clean stainless steel surfaces in the direction of the grain only. Special stainless steel cleaning products are available from our after-sales service or from specialist retailers. Apply a very thin layer of the cleaning product with a soft cloth.
Painted surfaces	Hot soapy water: Clean using a damp dish cloth and dry with a soft cloth/towel. Do not use any stainless steel cleaners.
Aluminium and plastic	Glass cleaner: Clean with a soft cloth.
Glass	Glass cleaner: Clean with a soft cloth. Do not use a glass scraper.
Operating controls	Hot soapy water: Clean using a damp dish cloth and dry with a soft cloth. Risk of damage to the electronics from penetrating moisture. Never clean operator controls with a wet cloth. Do not use any stainless steel cleaners.

Cleaning the metal mesh grease filters

These instructions apply to several appliance variants. It is possible that individual features are described which do not apply to your appliance.

Warning

Risk of fire!

Grease deposits in the grease filter may catch fire.

Clean the grease filter at least every 2 months.

Never operate the appliance without the grease filter.

Notes

- Do not use any aggressive, acidic or alkaline cleaning agents.
- When cleaning the metal mesh grease filters, also clean the holder for the metal mesh grease filters in the appliance using a damp cloth.
- The metal mesh grease filters can be cleaned in the dishwasher or by hand.

In the dishwasher:

Note: If the metal mesh grease filters are cleaned in the dishwasher, slight discolouration may occur. This has no effect on the function of the metal mesh grease filters.

- Do not clean heavily soiled metal mesh grease filters together with utensils.
- Place the metal mesh grease filters loosely in the dishwasher. The metal mesh grease filters must not be wedged in.

By hand:

Note: You can use a special grease solvent for stubborn dirt. It can be ordered via the Online Shop.

- Soak the metal mesh grease filters in a hot soapy solution.
- Clean the filters with a brush and then rinse them thoroughly.
- Leave the metal mesh grease filters to drain.

Removing metal grease filter

1. Open the lock and fold down the metal grease filter. While doing this, place the other hand under the metal grease filter.
2. Take the metal grease filter out of the holder.

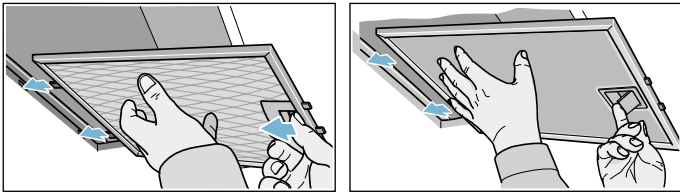

For edge extraction filters, pull the metal grease filter downwards. While doing this, place the other hand under the metal grease filter.

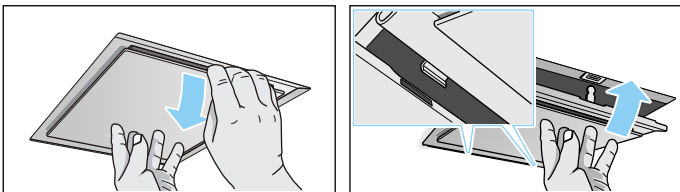

For additional filters, open the lock and fold down the metal grease filter. While doing this, place the other hand under the metal grease filter.

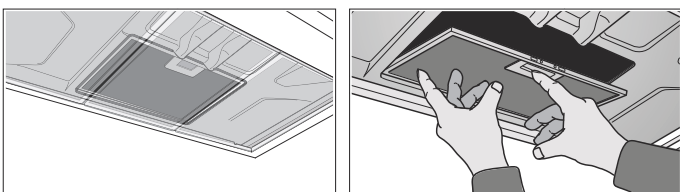

Notes

- Grease can accumulate in the bottom of the metal grease filter.
- Hold the metal grease filter level, otherwise grease will drip out.

3. Clean the metal grease filter.

Installing the metal mesh grease filter

1. Insert the metal mesh grease filter. While doing this, place the other hand under the metal mesh grease filter.
2. Fold the metal mesh grease filter upwards, locking it in place.

? Trouble shooting

Malfunctions often have simple explanations. Please read the following notes before calling the after-sales service.

⚠ Warning

Risk of electric shock!

Incorrect repairs are dangerous. Repairs may only be carried out and damaged power cables replaced by one of our trained after-sales technicians. If the appliance is defective, unplug the appliance from the mains or switch off the circuit breaker in the fuse box. Contact the after-sales service.

Malfunction table

Problem	Possible cause	Solution
The appliance does not work	The plug is not plugged in.	Connect the appliance to the electricity supply
	Power cut	Check whether other kitchen appliances are working
	Faulty fuse	Check in the fuse box to make sure that the fuse for the appliance is OK
The lighting does not work.	The bulbs are faulty.	For information on changing the bulbs, see the "Replacing Bulbs" section.

Replacing bulbs

These instructions apply to several appliance variants. It is possible that individual features are described which do not apply to your appliance.

⚠ Warning

Risk of electric shock!

When changing the bulbs, the bulb socket contacts are live. Before changing the bulb, unplug the appliance from the mains or switch off the circuit breaker in the fuse box.

Important Only use a bulb of the same type and same power (see the bulb holder or rating plate inside the appliance) – to do this, remove the metal mesh grease filter.

Replacing halogen bulbs

Note: When inserting halogen bulbs, do not touch the glass tube. Use a clean cloth to insert the halogen bulbs.

1. Carefully remove the bulb ring using a suitable tool.
2. Pull out the bulb and replace it with a bulb of the same type.

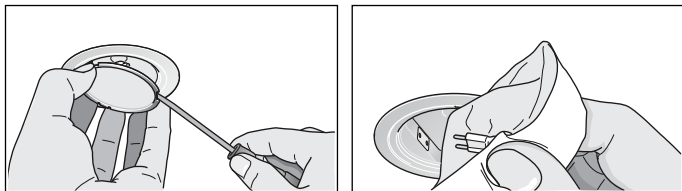

3. Insert the bulb cover.
4. Insert the mains plug or switch on the fuse again.

LED lights

Defective LED lights may be replaced by the manufacturer, their customer service or a qualified technician (electrician) only.

Warning

Risk of injury!

The light emitted by LED lights is very dazzling, and can damage the eyes (risk group 1). Do not look directly into the switched on LED lights for longer than 100 seconds.

Customer service

When calling us, please give the product number (E no.) and the production number (FD no.) so that we can provide you with the correct advice. The rating plate with these numbers can be found inside the appliance (remove the metal mesh grease filter to gain access).

You can make a note of the numbers of your appliance and the telephone number of the after-sales service in the space below to save time should it be required.

E no.	FD no.
After-sales service 	

Please be aware that a visit by an after-sales engineer will be charged if a problem turns out to be the result of operator error, even during the warranty period.

Please find the contact data of all countries in the enclosed customer service list.

To book an engineer visit and product advice

GB 0344 892 8979

Calls charged at local or mobile rate.

IE 01450 2655

0.03 € per minute at peak. Off peak 0.0088 € per minute.

Rely on the professionalism of the manufacturer. You can therefore be sure that the repair is carried out by trained service technicians who carry original spare parts for your appliances.

Accessories for circulating-air mode

(not included in the delivery)

Notes

- Follow the installation instructions supplied with the accessories.
- For appliances with an additional internal filter, only the CleanAir recirculation module can be used.

Basic equipment: Starter set for circulating-air mode - narrow

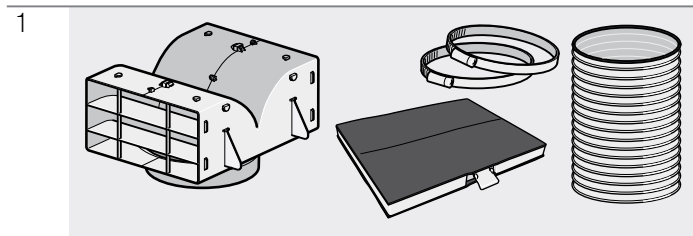

Throw-away filter

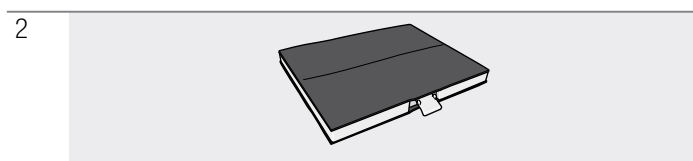

Basic equipment: Starter set for circulating-air mode - wide

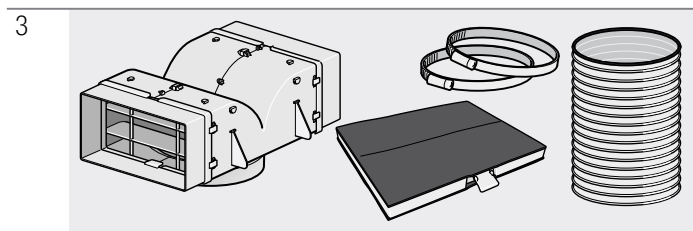

Throw-away filter

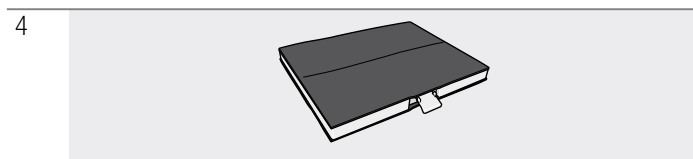

Basic equipment: CleanAir recirculation module - narrow

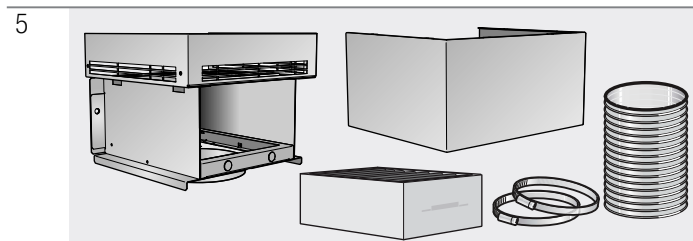

Throw-away filter

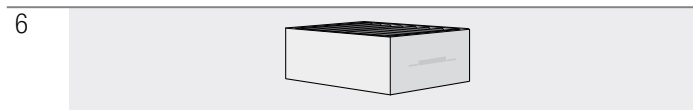

Basic equipment: CleanAir recirculation module - wide

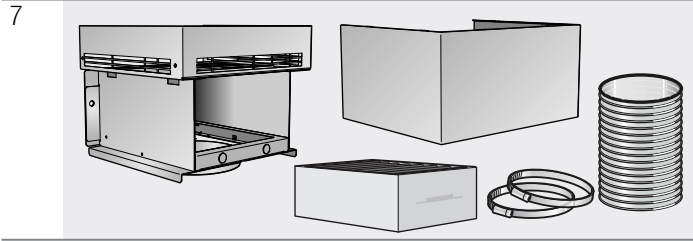

Throw-away filter

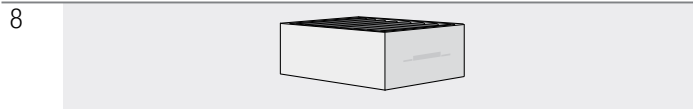

1	DHZ 5325 channel width 260 mm
2	DHZ 5326 channel width 260 mm
3	DHZ 5345 channel width 345 mm
4	DHZ 5346 channel width 345 mm
5	DSZ 6200 channel width 260 mm
6	DSZ 5201 channel width 260 mm
7	DSZ 6240 channel width 345 mm
8	DSZ 5201 channel width 345 mm

INSTALLATION INSTRUCTIONS

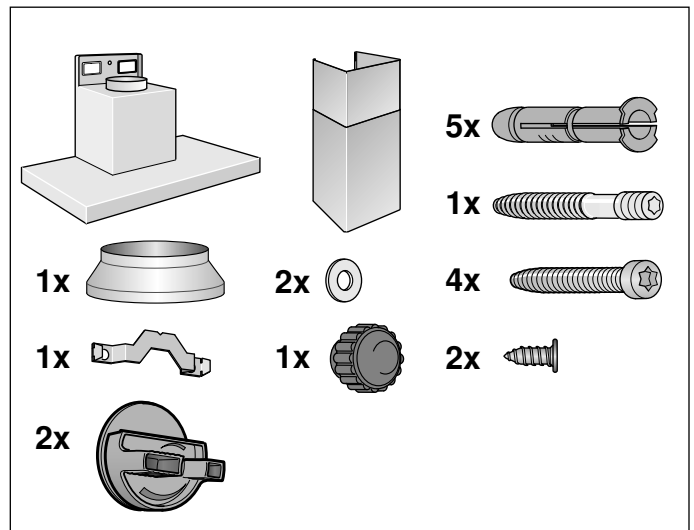
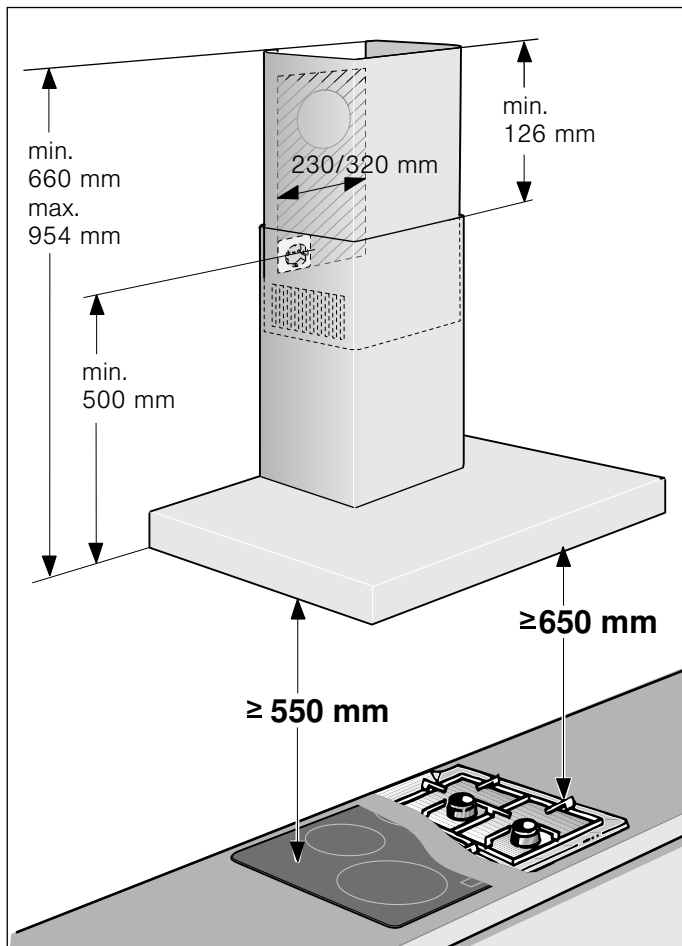

- This appliance is installed on the wall.
- Follow the enclosed installation instructions for additional special accessories (e.g. for circulating-air mode).
- The surfaces of the appliance are sensitive. Avoid damaging them during installation.

Important safety information

Read these instructions carefully. Only then will you be able to operate your appliance safely and correctly. Retain the instruction manual and installation instructions for future use or for subsequent owners.

The appliance can only be used safely if it is correctly installed according to the safety instructions. The installer is responsible for ensuring that the appliance works perfectly at its installation location.

The width of the extractor hood must correspond at least with the width of the hob.

For the installation, observe the currently valid building regulations and the regulations of the local electricity and gas suppliers.

When conveying the exhaust air, official and legal regulations (e.g. state building regulations) must be followed.

⚠ Warning
Risk of death!

Risk of poisoning from flue gases that are drawn back in. The exhaust air must not be conveyed into a functioning smoke or exhaust gas flue or into a shaft which is used to ventilate installation rooms that contain heating appliances. If the exhaust air is to be conveyed into a non-functioning smoke or exhaust gas flue, you must obtain the consent of the heating engineer responsible.

⚠ Warning
Danger of death!

Risk of poisoning from flue gases that are drawn back in.

Always ensure adequate fresh air in the room if the appliance is being operated in exhaust air mode at the same time as room air-dependent heat-producing appliance is being operated.

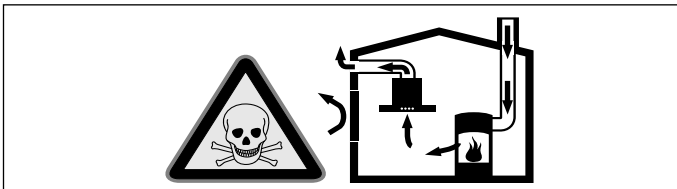

Room air-dependent heat-producing appliances (e.g. gas, oil, wood or coal-operated heaters, continuous flow heaters or water heaters) obtain combustion air from the room in which they are installed and discharge the exhaust gases into the open air through an exhaust gas system (e.g. a chimney).

In combination with an activated vapour extractor hood, room air is extracted from the kitchen and neighbouring rooms - a partial vacuum is produced if not enough fresh air is supplied. Toxic gases from the chimney or the extraction shaft are sucked back into the living space.

- Adequate incoming air must therefore always be ensured.
- An incoming/exhaust air wall box alone will not ensure compliance with the limit.

Safe operation is possible only when the partial vacuum in the place where the heat-producing appliance is installed does not exceed 4 Pa (0.04 mbar). This can be achieved when the air needed for combustion is able to enter through openings that cannot be sealed, for example in doors, windows, incoming/exhaust air wall boxes or by other technical means.

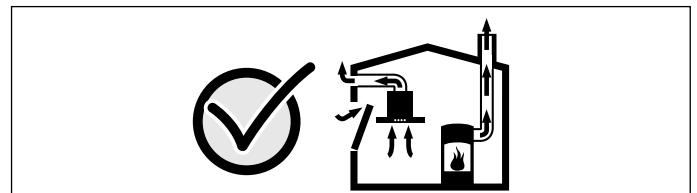

In any case, consult your responsible Master Chimney Sweep. He is able to assess the house's entire ventilation setup and will suggest the suitable ventilation measures to you.

Unrestricted operation is possible if the vapour extractor hood is operated exclusively in the circulating-air mode.

⚠ Warning
Danger of death!

Risk of poisoning from flue gases that are drawn back in. If installing a ventilation system in a room with a heat-producing appliance connected to a chimney/flue, the electricity supply to the hood must be equipped with a suitable safety switch.

⚠ Warning
Risk of fire!

Grease deposits in the grease filter may catch fire. The specified safety distances must be observed in order to prevent an accumulation of heat. Observe the specifications for your cooking appliance. If gas and electric hobs are operated together, the largest specified distance applies.

Only one side of the appliance may be installed directly next to a high-sided unit or a wall. The distance between the appliance and wall or high-sided unit must be at least 50 mm.

⚠ Warning**Risk of injury!**

- Components inside the appliance may have sharp edges. Wear protective gloves.
- The appliance may fall down if it has not been properly fastened in place. All fastening components must be fixed firmly and securely.
- The appliance is heavy. To move the appliance, 2 people are required. Use only suitable tools and equipment.

⚠ Warning**Risk of electric shock!**

Components inside the appliance may have sharp edges. These may damage the connecting cable. Do not kink or pinch the connecting cable during installation.

⚠ Warning**Risk of electric shock!**

It must always be possible to disconnect the appliance from the electricity supply. The appliance must only be connected to a protective contact socket which has been correctly installed. If the plug is no longer accessible following installation of the appliance, or a fixed connection is required, an all-pole isolating switch must be present on the installation side with a contact gap of at least 3 mm. The fixed connection must only be installed by an electrician.

⚠ Warning**Danger of suffocation!**

Packaging material is dangerous to children. Never allow children to play with packaging material.

👉 General information**Exhaust air mode****⚠ Warning****Risk of death!**

Risk of poisoning from flue gases that are drawn back in. The exhaust air must not be conveyed into a functioning smoke or exhaust gas flue or into a shaft which is used to ventilate installation rooms that contain heating appliances. If the exhaust air is to be conveyed into a non-functioning smoke or exhaust gas flue, you must obtain the consent of the heating engineer responsible.

If the exhaust air is conveyed through the outer wall, a telescopic wall box should be used.

Exhaust duct

Note: The device manufacturer does not assume any warranty for complaints attributable to the pipe section.

- The device achieves its optimum performance by means of a short, straight exhaust air pipe and as large a pipe diameter as possible.
- As a result of long rough exhaust air pipes, many pipe bends or pipe diameters that are smaller than 150 mm, the optimum extraction performance is not achieved and fan noise is increased.
- The pipes or hoses for laying the exhaust air line must consist of non-combustible material.

Round pipes

An inner diameter of 150 mm, but at least 120 mm, is recommended.

Flat ducts

The inner cross-section must correspond to the diameter of the round pipes.

dia. 150 mm ca. 177 cm²

dia. 120 mm ca. 113 cm²

- Flat ducts should not have any sharp deflections.
- Use sealing strips for deviating pipe diameters.

Checking the wall

- The wall must be level, vertical and adequately load-bearing.
- The depth of the bore holes must be the same length as the screws. The wall plugs must have a secure grip.
- The enclosed screws and wall plugs are suitable for solid brickwork. Suitable fasteners must be used for other structures (e.g. plasterboard, porous concrete, perforated bricks).
- The max. weight of the extractor hood is **40 kg**.

Electrical connection**⚠ Warning****Risk of electric shock!**

Components inside the appliance may have sharp edges. These may damage the connecting cable. Do not kink or pinch the connecting cable during installation.

The required connection data can be found on the rating plate inside the appliance; to do this, remove the metal mesh grease filter.

Length of the cable: approx. 1.30 m

This appliance complies with the EC interference suppression regulations.

⚠ Warning**Risk of electric shock!**

It must always be possible to disconnect the appliance from the electricity supply. The appliance must only be connected to a protective contact socket which has been correctly installed. If the plug is no longer accessible following installation of the appliance, or a fixed connection is required, an all-pole isolating switch must be present on the installation side with a contact gap of at least 3 mm. The fixed connection must only be installed by an electrician.

Installation

Preparing the installation

Caution!

Ensure that there are no electric wires, gas or water pipes in the area where holes are to be made.

1. Mark a vertical centre line on the wall from the ceiling to the lower edge of the extractor hood.
2. Mark positions for the screws and the contour of the attachment area.
3. Drill five 8 mm diameter holes to a depth of 80 mm for the attachments and press in the wall plugs flush with the wall.

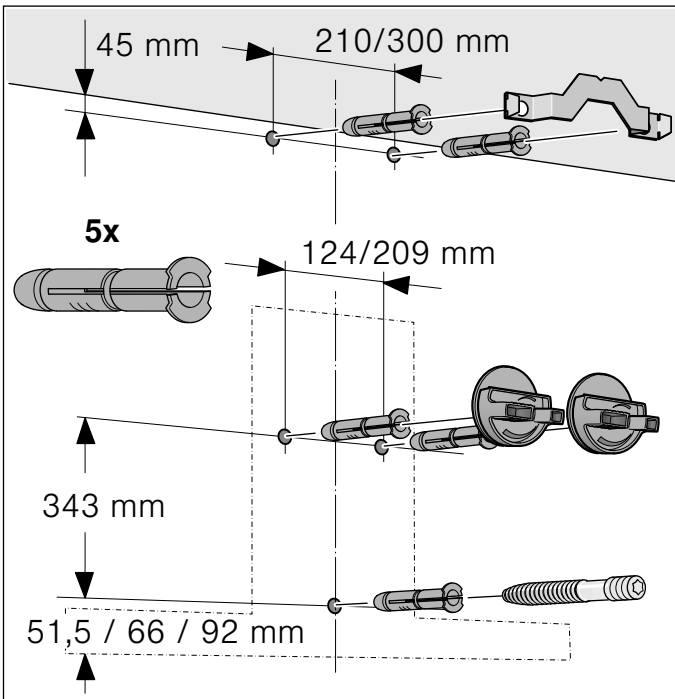

Installation

1. Screw on the fixing bracket for the flue duct. **A**

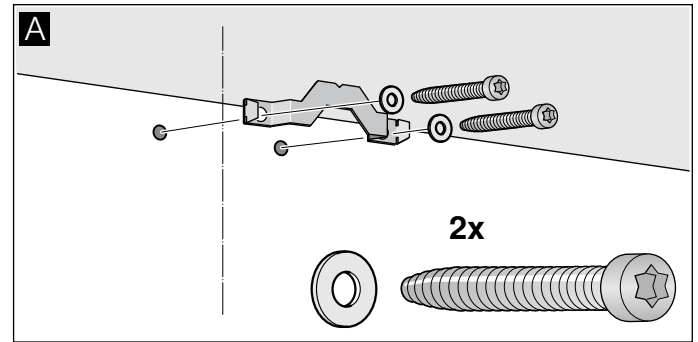

2. Screw on brackets for the extractor hood hand-tight. Do not firmly tighten the screws. **B**

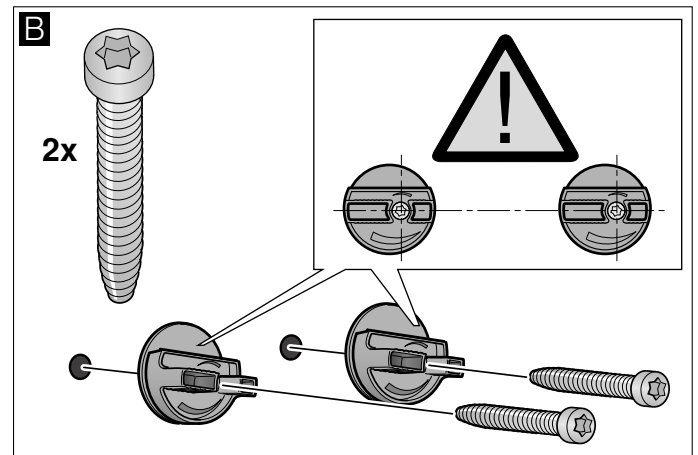

3. Screw in the threaded bolt, leaving it protruding out of the wall by 5–9 mm. **C**

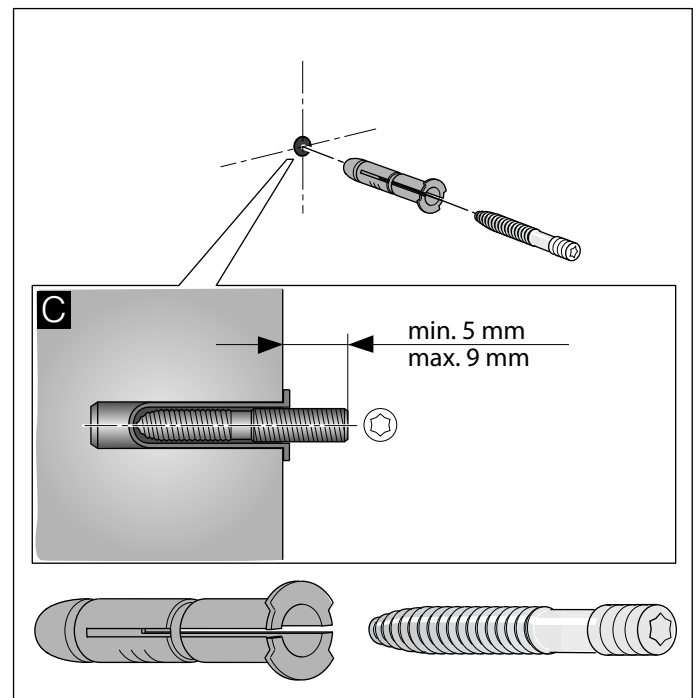

Attaching and aligning the appliance

1. First, remove the protective foil from the back of the appliance and, following installation, remove the foil completely.
2. When attaching the appliance, ensure that it engages firmly with the brackets. **D**
3. Align the appliance horizontally by turning the brackets. If required, the appliance can be moved to the right or left. **E**

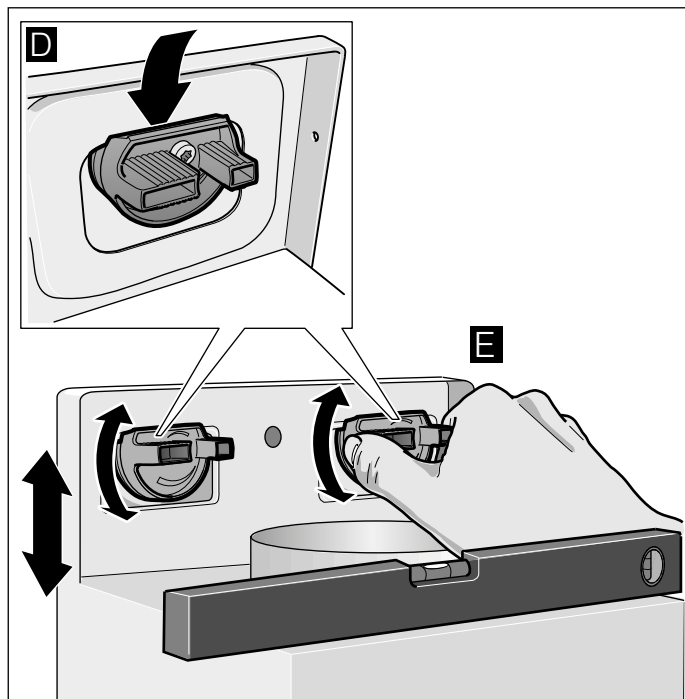

4. Firmly tighten the screws for the brackets. When doing so, hold the brackets securely in place. **F**
5. Firmly tighten the knurled nuts. **G**

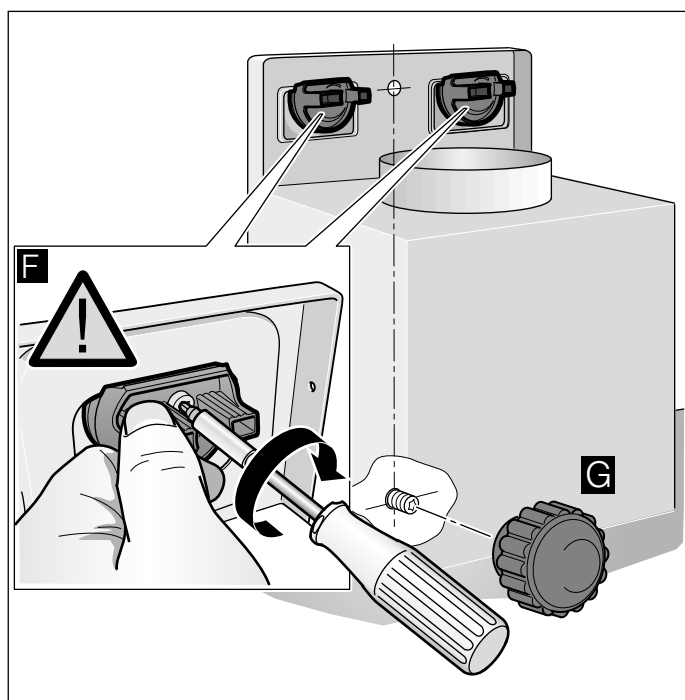

Connecting the pipes

Note: If using an aluminium pipe, smooth the connection area beforehand.

Exhaust-air pipe Ø 150 mm (recommended size)

Attach the exhaust-air pipe directly to the air-pipe connector and seal.

Exhaust-air pipe Ø 120 mm

1. Attach the reducing connector directly to the air-pipe connector.
2. Attach the exhaust air pipe to the reducing connector.
3. Seal both joints appropriately.

Attaching the flue duct

⚠ Warning

Risk of injury!

From sharp edges during installation. Always wear protective gloves while installing the appliance.

1. Separate the flue ducts.
To do this, remove the adhesive tape.
2. Remove the protective foil from both flue ducts.
3. Push one flue duct into the other.

Notes

- To prevent scratches, lay paper over the edges of the lower flue duct to protect the surface.
- Slots of the inner flue duct point downwards.

4. Place flue ducts on the appliance.
5. Push the inner flue duct upwards and attach it to the fixing brackets on the left and right. **A**
6. Press the flue duct downwards until it engages. **B**
7. Screw the flue duct to the sides of the fixing bracket using two screws. **C**

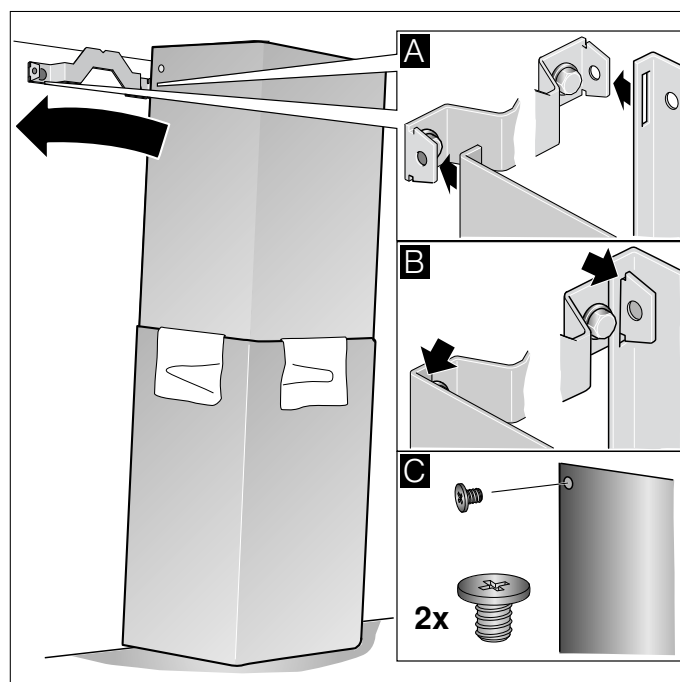



Robert Bosch Hausgeräte GmbH

Carl-Wery-Straße 34

81739 München

Germany

www.bosch-home.com



9001017124

950114