



Brief and handy: everything your dishwasher needs ...

Before using for the first time, read the Installation instructions and Operating instructions!

1

Adjusting the water softening system *

Ask your water supply company what the water hardness is and enter ...



| °Clarke | Hardness range | mmol/l | Setting | A | B | C |
|---------|----------------|---------|---------|----------------------------------|----------------------------------|----------------------------------|
| 0-8 | soft | 0-1,1 | 0 | <input type="radio"/> | <input type="radio"/> | <input type="radio"/> |
| 9-20 | medium | 1,2-2,9 | 1 | <input checked="" type="radio"/> | <input type="radio"/> | <input type="radio"/> |
| 21-26 | hard | 3,0-3,7 | 2 | <input checked="" type="radio"/> | <input checked="" type="radio"/> | <input type="radio"/> |
| 27-44 | hard | 3,8-6,2 | 3 | <input checked="" type="radio"/> | <input checked="" type="radio"/> | <input checked="" type="radio"/> |

* only before the first wash or if the water hardness has been changed

Quickly sorted ...

How to adjust

- Switch on ON/OFF switch.
 - Hold down button > and press START button until and flash.
 - Release the buttons.
 - The Salt refill indicator Dry indicator flash.
 - The A indicator lights up (= level 1).
- Change the setting as follows:
- Press the < button until the required setting has been selected.
 - Press START button.
 - The and displays go out. The selected setting is saved.
 - Close the door.

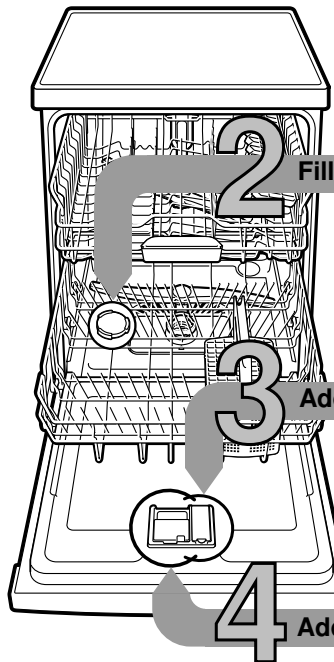

2 Filling the salt dispenser Dissolves limescale (not necessary when set to 0!) ...

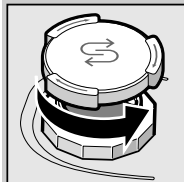

Open the lid.

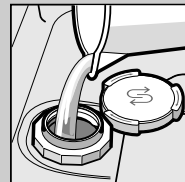

Only fill the salt dispenser with water before the first wash.

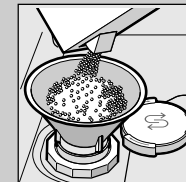

Add special salt (never use detergent!).

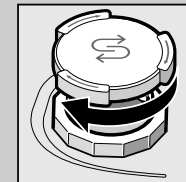

Close the lid. Rinse immediately.

3 Adding rinse aid Gets it sparkling clean ...

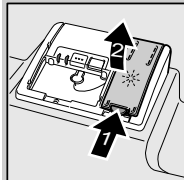

Press marking 1, lift lid 2.



For optimum drying results

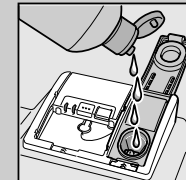

Add rinse aid.

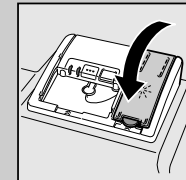

Close lid. CLICK!

4 Adding detergent A lot of dirt, a lot of detergent ...

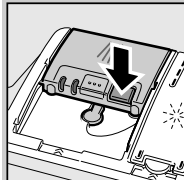

If required, open the cover (press button).



Attention: Combination products are not suitable for all programmes, follow manufacturer's instructions.

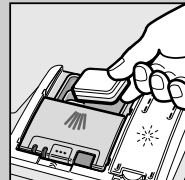

50 ml
25 ml
15 ml

Pour detergent into the dry detergent dispenser only.

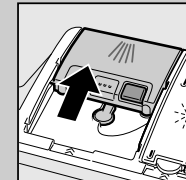

Slide cover shut, press. PLOP!

5 Switching on the appliance

6 Select programme Quick, economical or intensive ...

Overview of programmes

The max. possible number of programmes is illustrated in this overview. The corresponding programmes for your appliance can be found on the fascia.

The programme data has been measured in the laboratory according to European standard EN 50242. Deviations are possible in practice. * half normal load

The programme duration will be different if the machine is short of rinse additive or the function is turned off.

| | Intensive 70° | Auto 45°-65° | Eco 50° | Gentle 40° | Quick 45° | Prerinse |
|-----------------------------|---------------|--------------|---------|------------|-----------|----------|
| Duration: hs : mins | ← | 3:30 - 1:25 | → | ← | 0:29 * | 0:15 |
| Energy consumption in kWh | ← | 1,60 - 0,85 | → | ← | 0,80 | 0,05 |
| Water consumption in litres | ← | 19 - 9 | → | ← | 10 | 4 |

8 Start programme Here we go ...

9 Switch off the appliance Everything o.k. ...

Additional options **

Express Wash/Speed Perfect (VarioSpeed) ... is obtained by increased energy consumption at a constant cleaning performance.

Half load ... for a few items, saves water, energy and time.

Flexibility ...

Intensive zone ... perfect for a mixed load. Washing pressure and washing temperature are increased slightly.

Hygiene ... the temperature is increased during the final rinse process. This increases the hygiene status.

Extra drying ... improves the drying result by increased temperature in the final rinse. (Please take care with delicate dishes.)

** depending on model

Maintenance and care

For perfect rinsing results ...

Cleaning waste water pump

Filters
... check, if required, clean.

Rotate filter cylinder, remove filter system ...

rinse under running water ...

insert ...

Screw on filter system
NOTE MARK!

- Pull out the mains plug.
- Remove filters and scoop out water.
- Lever off cover (A).
- Check area around the fan impeller for foreign objects.
- Click cover shut (B).
- Insert filters.

Spray arms
... Remove blockages/deposits.

pull lower arm upwards ...

unscrew upper arm ...

clean spray nozzles under running water (if required use toothpicks) ...

Rectifying minor faults yourself ...

... as it is worth doing it yourself!

More information can be found in the operating instructions

| Fault | Possible causes | Remedial action |
|---------------------------------|--|--|
| Display "🔌" is lit | Supply fitting jammed or calcified | <ul style="list-style-type: none"> ▶ Open supply fitting. ▶ 1. Unscrew water connection. ▶ 2. Clean filter in the water connection. ▶ 3. Flow rate must be min. 10 l/min., when water supply is open. ▶ If the flow rate is less, replace the supply fitting. |
| | | |
| | Waste water hose is blocked or kinked | ▶ Install supply hose without kinks. |
| | Cover not attached to waste water pump | ▶ Install waste water hose without kinks. |
| | Waste water pump blocked | ▶ Attach cover (see above). |
| Display "🔧" flashes | Appliance has technical defect | ▶ Clean waste-water pump (see above). |
| | | ▶ Call factory customer service (state fault display). |
| | | ▶ Unplug appliance. |
| Residual water in the appliance | The programme has not yet ended | ▶ Switch on and close the appliance or terminate the programme (see Terminating the programme). |
| Rust on the cutlery | Cutlery not rust-resistant Hard knife blades are more susceptible | ▶ Use dishwasher-proof cutlery. |
| | Extraneous rust | ▶ Never wash rusting parts in the appliance. |

| Fault | Possible causes | Remedial action |
|--|---|---|
| Utensils are not clean | Utensils are situated close together or one above the other | ▶ Separate the utensils, prevent contact points. |
| Sand or gritty residue on the utensils | Too little detergent | ▶ Follow manufacturer's instructions (detergent). |
| | Unsuitable programme selected | ▶ Select a more intensive programme. |
| | Spray arm nozzles blocked | ▶ Clean the spray arms (see above). |
| | Filters dirty, not seated firmly | ▶ Clean the filters (see above). |
| | Spray arms blocked | ▶ Arrange the utensils so that the spray arms can rotate freely. |
| | | |
| Stains and streaks | Rinse aid dosage too high/too low | ▶ Streaks: reduce dosage. |
| | | ▶ Water or limescale stains: increase dosage. |
| Utensils not dry | Rinse aid | ▶ Increase dosage. |
| | | ▶ Change the product. |
| | The combined detergent used has a poor drying performance | ▶ Use rinse aid. |
| | Appliance setting | ▶ Activate intensive drying (depending on model). |
| Milky deposits on the utensils (can be removed) | Water softening system incorrectly set | ▶ Correctly set water softening system. |
| | No salt | ▶ Refill with special salt. |
| Milky deposits, glasses cloudy/tarnished (cannot be removed) | Glasses not dishwasher-proof | ▶ Use dishwasher-proof glasses. |
| | | ▶ Use a detergent suitable for glasses. |
| Plastic/utensils discoloured | Too little detergent | ▶ Follow manufacturer's instructions (detergent). |
| | Discoloration caused by food colourings (tomato sauce) | ▶ Discoloration is harmless; subsequent rinse cycles will cause it to fade. |

Terminating the programme ...

Loading the dishwasher correctly ...

While the programme is running, press the START button for approx. 3 sec. (Reset) until all displays go out.



The remaining programme sequence for draining the residual water takes approx. 1 minute.

Dishwasher-proof utensils not soiled with ash, wax, lubricating grease, ink or adhesive labels; remove large remnants of jam, milk products and food according to the operating instructions and check that the spray arms can rotate freely.