



Register your new Bosch now:  
[www.bosch-home.co.uk](http://www.bosch-home.co.uk)



**Filtrino THD20..**



**BOSCH**

en Instruction manual

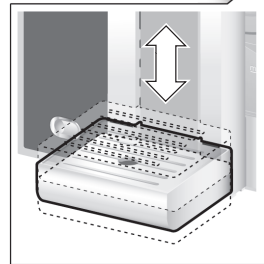
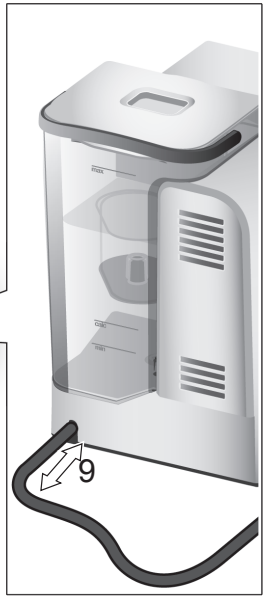
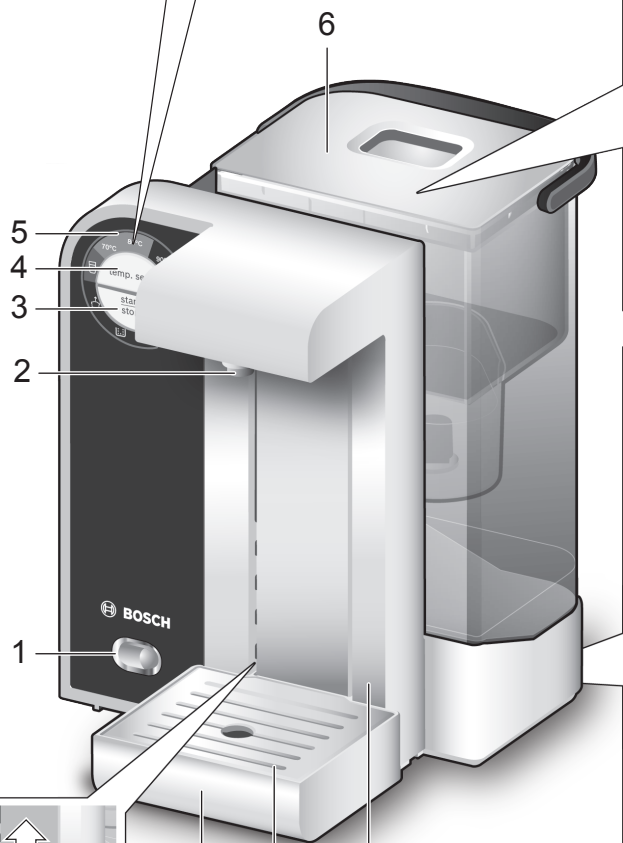
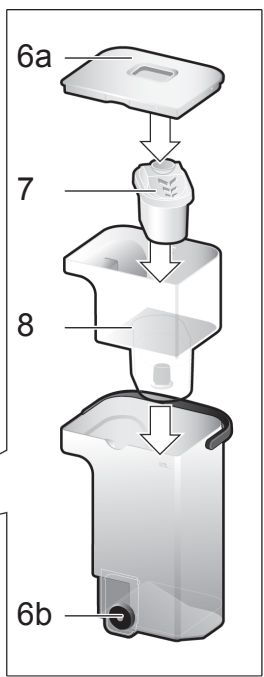
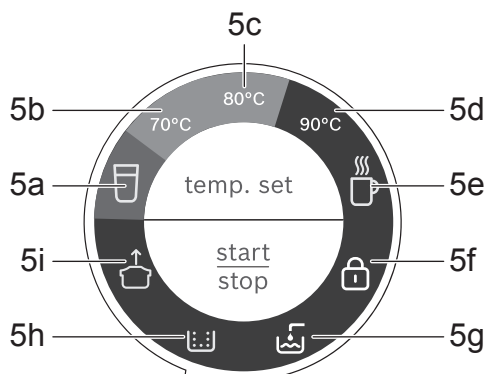

11a 11b 10

## Safety instructions

**Please read and follow the operating instructions carefully and keep them for later reference. Enclose these instructions when you give this appliance to someone else. This appliance is designed for the preparation of normal household quantities in the home, or in household-like, non-commercial environments. Household-like environments include staff kitchens in shops, offices, agricultural and other small businesses or for use by guests at bed-and-breakfast establishments, small hotels and similar residential facilities.**

### **⚠ Danger of electric shock!**

Connect and operate the appliance only according to the type plate specifications. To avoid potential hazards, repairs such as replacing a damaged cable must only be carried out by our customer service personnel.

This appliance can be used by children aged from 8 years and above and by persons with reduced physical, sensory or mental capabilities or lack of experience and knowledge if they have been given supervision or instruction concerning use of the appliance in a safe way and if they understand the hazards involved. Keep children under 8 years of age away from the appliance and connecting cable and do not allow them to use the appliance. Children shall not play with the appliance. Cleaning and user maintenance shall not be made by children unless they are older than 8 years and supervised.

Never immerse the appliance or mains cable in water.  
Never leave the appliance unattended while it is switched on!

Use only if power cord and appliance show no signs of damage.  
Should a fault occur, pull the plug or disconnect from the mains immediately.

Use the appliance in frost-free rooms only.  
Only use the appliance indoors at room temperature and up to 2000 m above sea level.

Drain the water tank once a day. For optimum results, fill the tank only with cool, fresh, non-carbonated water each day. Do not use chemically softened water.

**⚠ Risk of burns and fire!**

Keep in mind that with settings between 70 °C and  the water will be very hot.

When drawing water, steam may escape or hot water may splutter from the water outlet.

**⚠ Risk of suffocation!**

Do not allow children to play with packaging material.

**Congratulations on purchasing this Bosch appliance.**

**You have acquired a high-quality product that will bring you a lot of enjoyment.**







**Check your new appliance for any transport damage.**

**Dispose of the packaging (and of any old appliance being replaced) in an environmentally responsible manner.**

## Table of Contents

Safety instructions.....	3
Overview .....	5
Operating controls.....	5
Display elements.....	6
Using the appliance.....	6
Height adjustment .....	7
Fill quantity .....	7
Child lock.....	7
BRITA MAXTRA water filter system .....	8
Descaling .....	9
Maintenance and daily cleaning.....	10
Disposal.....	10
Simple troubleshooting .....	11
Technical data .....	12

## Overview

- 1 **on/off** switch
- 2 Water outlet
- 3 **start/stop** button
- 4 **temp. set** button
- 5 Display elements
  - a  Ambient water
  - b Water at 70 °C
  - c Water at 80 °C
  - d Water at 90 °C
  - e  Boiling water
  - f  Child lock
  - g  Add water / tank missing
  - h  Descale
  - i  Replace filter
- 6 Removable water tank
  - a Tank lid
  - b Float
- 7 Filter cartridge
- 8 Filter holder
- 9 Cable storage compartment
- 10 Height adjustment
- 11 Cup stand
  - a Drip tray
  - b Cup shelf

## Operating controls

### on/off switch

You use the **on/off** switch to turn the appliance on or completely off. When you switch it on, all nine display items light up briefly. The selected temperature (for example, ) lights up as long as the appliance is switched on.

**Note:** To save energy, it is recommended to turn the appliance off after each use.

### start/stop button









Press the **start/stop** button to draw water. To cut off the water supply early, press the button again.

**Note:** The temperature setting flashes while the machine provides water.

### temp. set button

Press the **temp. set** button to cycle through and select one of the temperature settings. The selected temperature lights up.





## Display elements

	On this setting, ambient water will be supplied.
<b>70°C</b> <b>80°C</b> <b>90°C</b>	With the <b>70°C</b> , <b>80°C</b> and <b>90°C</b> settings, the water will be heated to the selected temperature. Examples <b>70°C</b> – for white tea <b>80°C</b> – for green tea <b>90°C</b> – for instant beverages such as hot chocolate or coffee <b>Note:</b> The temperatures at the water outlet can vary by approximately $\pm 5\%$ .
	At this setting, the water will be boiled. This setting is suitable, for example, for black tea or instant soups.
	When the  icon lights up, the BRITA MAXTRA filter cartridge should be replaced. You can continue to heat water. For information about replacing the water filter cartridge, see the section titled “BRITA MAXTRA water filter system”. After changing the filter, hold down the <b>start/stop</b> button for at least 2 seconds,  will cease to light.
	The  icon lights up when the water tank needs to be refilled or is missing. Remove the water tank, fill it with fresh, cold water and return it to its correct position.
	The  icon lights up when the appliance needs to be descaled. Always follow the instructions in the “Descale” section when you descale the appliance.



The  icon lights up when the child lock is activated. At this point the water heater is deactivated, but you can still draw ambient water. To learn more about this setting, read the section titled “Child lock”.



 and  flash at the same time if there has been no hot water drawn for some time. For hygienic reasons, set the temperature to **90°C** or  and draw hot water (1 x). Extinguish  and ; the temperature last set lights up.

## Using the appliance

### General

With this appliance, you can filter water and dispense it at room temperature or heated to specific temperatures.

If you have questions regarding the filter cartridge, contact the BRITA Consumer Service at 0844 742 4800 (toll-free).

**Note:** The appliance is checked before delivery, which means there may be some isolated drops of water found. These drops of water are harmless, simply remove with a cloth.

### Setting up the appliance

Before you use the appliance for the first time, do the following:

- ▶ Remove film.
- ▶ Unroll or push in the right amount of cable from the cable compartment and plug the cable into a power outlet.
- ▶ Remove the water tank and clean it thoroughly under running water.
- ▶ Insert the filter cartridge as described in the section titled “BRITA MAXTRA water filter system”.
- ▶ Fill the water tank up to the **max** mark with fresh, cold water. Use only non-carbonated drinking water.
- ▶ Replace the water tank and push it firmly downward into place.

- ▶ Set the **on/off** switch to **on**. All display items will light up briefly, and then the **90°C** icon stays lit.
- ▶ Place a glass or cup holding at least 150 ml on the cup stand under the water outlet.
- ▶ Press the **start/stop** button to dispense one portion of water to rinse the appliance.

**Note:** Before using the appliance for the first time or after a long period of non-use, do not drink the first two glasses of water.

**The machine is now ready to use.**

### Dispensing water

- ▶ Set the cup stand to the appropriate height for the cup or glass.
- ▶ Place the cup or glass under the water outlet.
- ▶ Press the **temp. set** button to select the desired temperature.
- ▶ Press the **start/stop** button. The water will dispense from the outlet. The selected temperature flashes while the water is dispensed.

## Height adjustment

The adjustable cup stand lets you adjust the distance between your cup or glass and the water outlet. The lowest setting is suitable for taller glasses and cups. For smaller cups or soup cups you can insert the cup stand into one of the upper openings.



**Important:** Don't use the appliance without the cup stand.

## Fill quantity

The appliance ships with a preset fill quantity of 250 ml. You can change this quantity.

To adjust the fill quantity, proceed as follows:

- ▶ Hold down the **temp. set** button for at least 5 seconds.
- ▶ The indicator for the currently set fill quantity flashes.
- ▶ Press the **temp. set** button to select the desired fill quantity:
 



	= approx. 120 ml
<b>70°C</b>	= approx. 150 ml
<b>80°C</b>	= approx. 200 ml
<b>90°C</b>	= approx. 250 ml
	= approx. 300 ml
- ▶ Press the **start/stop** button – the setting is now stored.

**Important:** To keep the dispensed water from overflowing, make sure that you place a sufficiently large glass or cup under the water outlet.

**Note:** To change this setting at any time, repeat the above procedure.

## Child lock

For safety reasons, this appliance is equipped with a child lock. To activate it, proceed as follows:

- ▶ Press and hold the **temp. set** and **start/stop** buttons simultaneously for at least 5 seconds. The  and  icons light up.

**Info:** When the child lock is activated, only ambient water is available. When you press the **temp. set** button, the  flashes; all other settings are blocked.

To deactivate the child lock, proceed as follows:

Press and hold the **temp. set** and **start/stop** buttons simultaneously for at least 5 seconds. The  icon goes out.

## BRITA MAXTRA water filter system

In models equipped with a water filter system, only BRITA MAXTRA water filter cartridges may be used.

BRITA MAXTRA cartridges can be purchased from retailers or directly from Bosch Customer Service. (See the back pages of these instructions for contact information).



The appliance can be used with or without a filter cartridge.

Keep in mind that you will enjoy the benefits of BRITA filtration only if a MAXTRA filter cartridge is installed in the appliance. Tea and coffee also have more aroma when prepared with fresh, BRITA-filtered water.

To use the machine without a filter, simply remove the filter holder and the filter cartridge and adjust the machine settings accordingly.

**Important:** The Filter Yes/No setting controls the filter replacement indicator.

### Changing the filter setting

- ▶ Turn the appliance off with the **on/off** switch.
- ▶ Press and hold the **temp. set** button.
- ▶ Turn the appliance back on with the **on/off** switch – the  icon flashes.
- ▶ Press the **start/stop** button to select the Filter Yes/No setting:
  - Yes =  lights up
  - or
  - No =  does not light up
- ▶ Release the **temp. set** button – the setting is now stored, and the most recently selected temperature lights up.

**Note:** To change this setting at any time, repeat the above procedure.

After setting the filter to “yes”, the symbol  will light up after a certain time during operation. The BRITA MAXTRA filter cartridge is exhausted and needs to be changed.

To install a new filter cartridge, proceed as follows:

### Preparing and installing the BRITA MAXTRA filter cartridge

- ▶ Remove the filter cartridge’s protective packaging.
- ▶ Immerse the filter cartridge in cold tap water and shake it lightly (for about five seconds) to remove any air bubbles.
- ▶ Take the filter holder out of the water tank and firmly insert the cartridge into the holder until you hear a click.
- ▶ Hold the filter holder under the water tap and fill it with fresh, cold water; let the water run through the BRITA MAXTRA filter cartridge.
- ▶ Repeat this procedure two or three times.
- ▶ Place the filter holder with the filter cartridge back into its position in the empty water tank and fill the tank with cold tap water.
- ▶ Hold down **start/stop** button for at least 2 seconds to delete .

**Note:** To replace the cartridge, simply pull on the strap attached to the top of the cartridge. When installing a new cartridge, follow the above steps for preparing and inserting a cartridge.



Used BRITA MAXTRA water filter cartridges can be disposed of with the regular household garbage. If you have more questions, contact BRITA Consumer Service at 0844 742 4800 (toll-free).

### Important information

- Always store spare filter cartridges sealed in the original packaging in a cool and dry place.
- BRITA water filters are designed for use only with municipally treated tap water (note: this water is constantly controlled and according to legal regulations safe to drink) or with water from private supplies which has been tested as safe to drink. If an instruction is received from the authorities that mains water must be



boiled, the BRITA filtered water must also be boiled. When the instruction to boil water is no longer in force, the appliance and filter funnel must be cleaned and a new cartridge inserted to ensure any residual contaminants are removed.

- Please filter cold tap water only.
- Clean the appliance and filter funnel regularly.
- For certain groups of people (e.g. those with impaired immunity and for babies), it is generally recommended that tap water should be boiled; this also applies to BRITA filtered water.
- For hygiene reasons, the MAXTRA cartridge contents are subject to special treatment with silver. A very small amount of silver may be transferred to the water. This transference would be within the World Health Organisation (WHO) guidelines.
- During the filtering process, there may be a slight increase in potassium content. However, one litre of BRITA filtered water contains less potassium than e.g. an apple. If you have kidney disease and/or follow a potassium restricted diet, we recommend that you consult your doctor before using a BRITA water filter.
- Should your BRITA appliance not be in use for a prolonged period (e.g. holiday), BRITA recommends that you take out the cartridge, discard any water left inside the BRITA water filter and loosely insert the MAXTRA cartridge again. Before using the BRITA water filter again take out the cartridge, clean the appliance and funnel thoroughly and repeat the steps of the instructions for use in chapter: “Preparing and installing the BRITA MAXTRA filter cartridge”.
- BRITA filtered water is dedicated for human consumption. It is a perishable food and as such please consume within 1 to 2 days.
- Like each natural product, the consistency of the BRITA MicroporeFilter is subject to natural variances. This can lead to a slight abrasion of small carbon particles into your filtered water, noticeable as

black bits. These particles have no negative health effects. If ingested, they will not harm the human body. In case you observe carbon particles, BRITA recommends to flush the cartridge several times or until the black bits disappear.

- BRITA cannot accept responsibility or liability if you do not respect our recommendations for the use and exchange of the BRITA filter cartridge.

## Descaling

Your appliance has an automatic descaling programme. When the  icon lights up, run the descaling programme as soon as possible. If the descaling programme is not run as instructed, the appliance may be damaged.

**Tip:** With very hard, calciferous water, please descale the appliance more often than the  symbol is displayed. Even filtered water contains low amounts of calcium carbonate.

- ▶ Turn the appliance off with the **on/off** switch.
- ▶ Press and hold the **start/stop** button.
- ▶ Turn the appliance back on with the **on/off** switch.
- ▶ Release the **start/stop** button as soon as the  symbol lights up.

Now proceed as described under “Running the descaling programme”.

**Suitable descaling agents are available from Bosch Customer Service (Article No. 310967) or from specialty retailers.**

### Notes:

- Never interrupt the descaling programme.
- Never drink any of the liquids used in descaling.
- Never use vinegar or vinegar-based products.
- Always remove the filter holder and the filter cartridge before starting the descaling programme.

### Running the descaling programme

- ▶ Remove the water tank, pour out any remaining water, and reinsert it.
- ▶ Prepare the descaling solution according to the manufacturer's instructions and pour it into the water tank up to the **calc** mark. A descaling agent approved especially for this machine is available from Bosch Customer Service (Article No. 310967) or from specialty retailers.
- ▶ Place a container holding at least 500 ml under the water outlet. The container must fit the cup stand exactly and must remain in place. Set the cup stand to the lowest position.
- ▶ Press and hold the **start/stop** button for at least 10 seconds to start the descaling programme.
- ▶ The descaling programme will now run automatically. The  icon flashes while the programme is running. (The programme runs for approx. 10 minutes). The descaling solution is pumped through the appliance in multiple phases and then runs into the container until the water tank is almost empty. A small amount of solution is always left in the tank.
- ▶ When the most recently selected temperature icon lights up, the descaling program has finished.
- ▶ Rinse the water tank thoroughly and fill up to the **max** mark with fresh water.
- ▶ Now select and draw warm water three times to rinse out the appliance. Do not drink this water!

**Important:** Do not interrupt the descaling process under any circumstances. If the programme is interrupted because of, for example, too little water or a power failure, it must be restarted.

**The appliance is now fully operational again, and you can re-insert the filter holder with the BRITA MAXTRA filter cartridge.**

## Maintenance and daily cleaning

### Risk of electric shock

Switch off and unplug the appliance before cleaning.

Never immerse the appliance in water. Do not use a steam cleaner.

- ▶ Wipe the housing with a damp soft cloth.
- ▶ Rinse out the water tank with water only. Do not place it in the dishwasher.
- ▶ The lid of the water tank and all parts of the cup shelf can be washed in the dishwasher.
- ▶ Clean water tank daily and refill with fresh water.

## Disposal





Dispose of packaging in an environmentally-friendly manner. This appliance is labelled in accordance with European Directive 2012/19/EG concerning used electrical and electronic appliances (waste electrical and electronic equipment – WEEE). The guideline determines the framework for the return and recycling of used appliances as applicable throughout the EU. Please ask your specialist retailer about current disposal facilities.





## Guarantee

The guarantee conditions for this appliance are as defined by our representative in the country in which it is sold. Details regarding these conditions can be obtained from the dealer from whom the appliance was purchased. The bill of sale or receipt must be produced when making any claim under the terms of this guarantee.

Changes reserved.

## Simple troubleshooting

Problem	Possible cause	Remedy
The appliance is not working and none of the control lights are illuminated.	The appliance may have no power supply.	Check the appliance to see if it is connected to the power supply.
The machine is running but it is not producing any water.	The water tank is not fitted correctly.	Please check that the water tank is correctly fitted.
	The water tank was removed during the brewing stage or there is air in the system.	Draw the water once again.
	The float in the water tank is stuck.	Clean the water tank and release the float.
It is not possible to set the temperature.	The child-proof lock is activated.	Deactivate the child-proof lock.
The water splutters when drawn.	The cup stand is set too low.	Reduce the distance between the water outlet and the cup by raising the cup stand.
	Build-up of limescale in the water outlet.	Descale the appliance as described in the chapter "Descaling".
The temperature of the water drawn is too low.	The temperature set displays the water temperature directly at the water outlet.	Select a higher temperature.
	The glass or cup is too cold.	Rinse out the glass or cup with hot water before filling it or draw water first to heat it up.
	There is a build-up of limescale in the appliance.	Descale the appliance as described in the instructions. With extremely calciferous water, descale the appliance more often than the symbol is displayed.
Water is collecting in the water outlet.	Condensation water may result due to physical properties.	It is normal for condensation to appear, simply wipe it away.
The  symbol is lighting even though there is a sufficient amount of water in the water tank.	The float in the water tank is stuck.	Clean the water tank and release the float.
 lights up after only a few drawing cycles.	Possible operating error.	Descale the appliance as described in the chapter "Descaling".
 lights up even though a filter has been used.	Even filtered water contains low amounts of calcium carbonate.	Descale the appliance as described in the chapter "Descaling".
 lights up even though the appliance has just been descaled.	The descaling programme was interrupted because of, for example, too little water or a power failure.	Carry out the descaling programme again as described in the chapter "Descaling".

Problem	Possible cause	Remedy
Loud “cooking and pumping” noises are heard during the drawing process.	The filter is set to “yes” (see chapter “BRITA MAXTRA water filter system”) but there is no filter in place. Build-up of limescale in the appliance.	Descale the appliance as described in the chapter “Descaling”. Finally, programme the correct setting.
	The used water is particularly calciferous. Build-up of limescale in the appliance.	The appliance must be descaled more often than the  symbol lights up. Follow the instructions outlined in the chapter “Descaling”.
 ,  and  are all flashing at the same time, it is not possible to draw any water.	The appliance has a fault.	Disconnect the appliance from the power supply and contact Customer Service.
<b>If you are unable to rectify the problem, please contact Customer Service.</b>		

## Technical data

Power connection (voltage/frequency)	220-240 V / 50 Hz
Heater wattage	1600 W
Maximum static pump pressure	3.3 bar
Maximum water tank capacity (without filter)	2 litres
Length of power cable	80 cm
Dimensions (H x W x D)	290 x 223 x 267 mm
Weight, empty	2.3 kg

## Kundendienst – Customer Service

### **DE Deutschland, Germany**

BSH Hausgeräte Service GmbH  
Zentralwerkstatt für kleine  
Hausgeräte  
Trautskirchener Strasse 6-8  
90431 Nürnberg  
Online Auftragsstatus, Filterbeutel-  
Konfigurator und viele weitere  
Infos unter:  
[www.bosch-home.com](http://www.bosch-home.com)

Reparaturservice, Ersatzteile &  
Zubehör, Produkt-Informationen:  
Tel.: 0911 70 440 040  
mailto:cp-servicecenter@  
bshg.com  
Wir sind an 365 Tagen rund um die Uhr  
erreichbar.

### **AE United Arab Emirates,**

الإمارات العربية المتحدة

BSH Home Appliances FZE  
Round About 13,  
Plot Nr MO-0532A  
Jebel Ali Free Zone – Dubai  
Tel.: 04 881 4401  
mailto:service.uae@bshg.com  
[www.bosch-home.com/ae](http://www.bosch-home.com/ae)

### **AL Republika e Shqiperise, Albania**

AERTECH SH.P.K.  
Rruga Qemal Stafa  
Pallati i ri perball Prokuroris se  
Pergjithshme  
Hyrja C Kati 10  
Tirana  
Tel.: 066 206 47 94  
mailto:g.volina@aertech.al

### **AT Österreich, Austria**

BSH Hausgeräte  
Gesellschaft mbH  
Werkskundendienst  
für Hausgeräte  
Quellenstrasse 2  
1100 Wien  
Tel.: 0810 550 511\*  
Fax: 01 605 75 51 212  
mailto:vie-stoerungsannahme@  
bshg.com  
Hotline für Espresso-Geräte:  
Tel.: 0810 700 400\*  
[www.bosch-home.at](http://www.bosch-home.at)

\*innerhalb Österreichs zum Regionaltarif

### **AU Australia**

BSH Home Appliances Pty. Ltd.  
7-9 Arco Lane  
HEATHERTON, Victoria 3202  
Tel.: 1300 368 339  
mailto:bshau-as@bshg.com  
[www.bosch-home.com.au](http://www.bosch-home.com.au)

### **BA Bosna i Hercegovina, Bosnia-Herzegovina**

"HIGH" d.o.o.  
Gradačacka 29b  
71000 Sarajevo  
Info-Line: 061 100 905  
Fax: 033 213 513  
mailto:delicnanda@hotmail.com

### **BE Belgique, België, Belgium**

BSH Home Appliances S.A.  
Avenue du Laerbeek 74  
Laarbeeklaan 74  
1090 Bruxelles – Brussel  
Tel.: 070 222 141  
Fax: 024 757 291  
mailto:bru-repairs@bshg.com  
[www.bosch-home.be](http://www.bosch-home.be)

### **BG Bulgaria**

BSH Domakinski Uredi  
Bulgaria EOOD  
115K Tsarigradsko Chausse Blvd.  
European Trade Center Building,  
5th floor  
1784 Sofia  
Tel.: 02 892 90 47  
Fax: 02 878 79 72  
mailto:informacia.servis-bg@  
bshg.com  
[www.bosch.home.bg](http://www.bosch.home.bg)

### **BH Bahrain, مملكة البحرين**

Khalaifat Company  
Manama  
Tel.: 01 7400 553  
mailto:service@khalaifat.com

### **BY Belarus, Беларусь**

ООО "БСХ Бытовая техника"  
тел.: 495 737 2961  
mailto:mok-kdhl@bshg.com

### **CH Schweiz, Suisse, Svizzera, Switzerland**

BSH Hausgeräte AG  
Werkskundendienst für  
Hausgeräte  
Fahrweidstrasse 80  
8954 Geroldswil  
mailto:ch-info.hausgeraete@  
bshg.com  
Service Tel.: 0848 840 040  
Service Fax: 0848 840 041  
mailto:ch-reparatur@bshg.com  
Ersatzteile Tel.: 0848 880 080  
Ersatzteile Fax: 0848 880 081  
mailto:ch-ersatzteil@bshg.com  
[www.bosch-home.com](http://www.bosch-home.com)

### **CY Cyprus, Κύπρος**

BSH Ikiakes Syskeves-Service  
39, Arh. Makaanouri III Str.  
2407 Egomi/Nikosia (Lefkosia)  
Tel.: 7777 8007  
Fax: 022 658 128  
mailto:bsh.service.cyprus@  
cytanet.com.cy

### **CZ Česká Republika, Czech Republic**

BSH domácí spotřebiče s.r.o.  
Firemní servis domácích  
spotřebičů  
Pekařská 10b  
155 00 Praha 5  
Tel.: 0251 095 546  
Fax: 0251 095 549  
[www.bosch-home.com/cz](http://www.bosch-home.com/cz)

### **DK Danmark, Denmark**

BSH Hvidevarer A/S  
Telegrafvej 4  
2750 Ballerup  
Tel.: 44 89 89 85  
Fax: 44 89 89 86  
mailto:BSH-Service.dk@  
BSHG.com  
[www.bosch-home.dk](http://www.bosch-home.dk)

### **EE Eesti, Estonia**

SIMSON OÜ  
Raua 55  
10152 Tallinn  
Tel.: 0627 8730  
Fax: 0627 8733  
mailto:teenindus@simson.ee

### **ES España, Spain**

BSH Electrodomésticos  
España S.A.  
Servicio Oficial del Fabricante  
Parque Empresarial PLAZA,  
C/ Manfredonia, 6  
50197 Zaragoza  
Tel.: 902 245 255  
Fax: 976 578 425  
mailto:CAU-Bosch@bshg.com  
[www.bosch-home.es](http://www.bosch-home.es)

### **FI Suomi, Finland**

BSH Kodinkoneet Oy  
Itälahdenkatu 18 A, PL 123  
00201 Helsinki  
Tel.: 0207 510 700  
Fax: 0207 510 780  
mailto:Bosch-Service-  
FI@bshg.com  
[www.bosch-home.fi](http://www.bosch-home.fi)  
Lankapuhelimesta 8,28 snt/puhelu  
+ 7 snt/min (alv 23%)  
Matkapuhelimesta 8,28 snt/puhelu  
+ 17 snt/min (alv 23%)

**FR France**

BSH Electroménager S.A.S.  
50 rue Ardoin – BP 47  
93401 SAINT-OUEN cedex  
Service interventions à domicile:  
01 40 10 11 00

Service Consommateurs:  
0 892 698 010 (0,34 € TTC/mn)  
mailto:soa-bosch-conso@bshg.com  
Service Pièces Détachées et  
Accessoires:  
0 892 698 009 (0,34 € TTC/mn)  
www.bosch-home.fr

**GB Great Britain**

BSH Home Appliances Ltd.  
Grand Union House  
Old Wolverton Road  
Wolverton  
Milton Keynes MK12 5PT  
To arrange an engineer visit, to  
order spare parts and accessories  
or for product advice please visit  
www.bosch-home.co.uk  
or call  
Tel.: 0844 892 8979\*

\*Calls from a BT landline will be charged at  
up to 3 pence per minute. A call set-up fee  
of up to 6 pence may apply.

**GR Greece, Ελλάδα**

BSH Ikiakies Siskeves A.B.E.  
Central Branch Service  
17 km E.O. Athinon-Lamias &  
Potamou 20  
14564 Kifisia  
Πανελλήνιο τηλέφωνο: 181 82  
(αστική χρέωση)  
www.bosch-home.gr

**HK Hong Kong, 香港**

BSH Home Appliances Limited  
Unit 1 & 2, 3rd Floor  
North Block, Skyward House  
3 Sham Mong Road  
Tai Kok Tsui, Kowloon  
Hong Kong  
Tel.: 2565 6151  
Fax: 2565 6681  
mailto:bosch.hk.service@bshg.com  
www.bosch-home.cn

**HR Hrvatska, Croatia**

BSH kućni uređaji d.o.o.  
Kneza Branimira 22  
10000 Zagreb  
Tel.: 01 640 36 09  
Fax: 01 640 36 03  
mailto:informacije.servis-hr@  
bshg.com  
www.bosch-home.com/hr

**HU Magyarország, Hungary**

BSH Háztartási Készülék  
Kereskedelmi Kft.  
Háztartási gépek márkaszervize  
Királyhágó tér 8-9  
1126 Budapest  
Hibabejelentés  
Tel.: 01 489 5461  
Fax: 01 201 8786  
mailto:hibabejelentes@bsh.hu  
Alkatrészrendelés  
Tel.: 01 489 5463  
Fax: 01 201 8786  
mailto:alkatrészrendeles@bsh.hu  
www.bosch-home.com/hu

**IE Republic of Ireland**

BSH Home Appliances Ltd.  
Unit F4, Ballymount Drive  
Ballymount Industrial Estate  
Walkinstown  
Dublin 12  
Service Requests,  
Spares and Accessories  
Tel.: 01450 2655  
Fax: 01450 2520  
www.bosch-home.co.uk

**IL Israel, ישראל**

C/S/B Home Appliance Ltd.  
Ullei Building  
2, Hamelacha St.  
Industrial Park North  
71293 Lod  
Tel.: 08 9777 222  
Fax: 08 9777 245  
mailto:csb-serv@zahav.net.il  
www.bosch-home.co.il

**IN India, Bhārat, भारत**

BSH Customer Service Front Office  
Shop No.4, Everest Grande,  
Opp. Shanti Nagar Bus Stop,  
Mahakali Caves Road, Andheri East  
Mumbai 400093

**IS Iceland**

Smith & Norland hf.  
Noatuni 4  
105 Reykjavik  
Tel.: 0520 3000  
Fax: 0520 3011  
www.sminor.is

**IT Italia, Italy**

BSH Elettrodomestici S.p.A.  
Via. M. Nizzoli 1  
20147 Milano (MI)  
Numero verde 800 829 120  
mailto:info@bosch-elettrodomestici.it  
www.bosch-home.com/it

**KZ Kazakhstan, Қазақстан**

IP Turebekov Yerzhan  
Nurmanovich  
Jangeldina str. 15  
Shimkent 160018  
Tel.: 0252 31 00 06  
mailto:evrika\_kz@mail.ru

**LB Lebanon, لبنان**

Teheeni, Hana & Co.  
Boulevard Dora 4043 Beyrouth  
P.O. Box 90449  
Jdeideh 1202 2040  
Tel.: 01 255 211  
mailto:Info@Teheeni-Hana.com

**LT Lietuva, Lithuania**

Senuku prekybos centras UAB  
Jonavos g. 62  
44192 Kaunas  
Tel.: 0372 12146  
Fax: 0372 12165  
www.senukai.lt

**LU Luxembourg**

BSH électroménagers S.A.  
13-15 ZI Breedeweues  
1259 Senningerberg  
Tel.: 26349 300  
Fax: 26349 315  
mailto:lux-service.electromenager@  
bshg.com  
www.bosch-home.com/lu

**LV Latvija, Latvia**

General Serviss Limited  
Bullu street 70c  
1067 Riga  
Tel.: 07 42 41 37  
mailto:bt@olimpeks.lv  
Elkor Serviss  
Brivibas gatve 201  
1039 Riga  
Tel.: 067 0705 20; -36  
Fax: 067 0705 24  
mailto:domoservice@elkor.lv  
www.servisacentrs.lv

**MD Moldova**

S.R.L. "Rialto-Studio"  
ул. Щусева 98  
2012 Кишинев  
тел./факс: 022 23 81 80  
mailto:bosch-md@mail.ru

**ME Crna Gora, Montenegro**

Elektronika komerc  
Ul. Slobode 17  
84000 Bijelo Polje  
Tel./Fax: 050 432 575  
Mobil: 069 324 812  
mailto:ekobosch.servis@  
t-com.me

**MK Macedonia, Македонија**

GORENEC  
Jane Sandanski 69 lok.3  
1000 Skopje  
Tel.: 022 454 600  
Mobil: 070 697 463  
mailto:gorenecc@yahoo.com

**MT Malta**

Oxford House Ltd.  
Notabile Road  
Mriehel BKR 14  
Tel.: 021 442 334  
Fax: 021 488 656  
www.oxfordhouse.com.mt

**MV Raajjeyge Jumhooriyyaa, Maldives**

Lintel Investments  
Ma. Maadheli, Majeedhee Magu  
Malé  
Tel.: 0331 0742  
mailto:mohamed.zuhuree@  
intel.com.mv

**NL Nederland, Netherlands**

BSH Huishoudapparaten B.V.  
Taurusavenue 36  
2132 LS Hoofddorp  
Storingsmelding:  
Tel.: 088 424 4010  
Fax: 088 424 4845  
mailto:bosch-contactcenter@  
bshg.com

Onderdelenverkoop:  
Tel.: 088 424 4010  
Fax: 088 424 4801  
mailto:bosch-onderdelen@bshg.com  
www.bosch-home.nl

**NO Norge, Norway**

BSH Husholdningsapparater A/S  
Grensesvingen 9  
0661 Oslo  
Tel.: 22 66 06 00  
Fax: 22 66 05 50  
mailto:Bosch-Service-NO@  
bshg.com  
www.bosch-home.no

**NZ New Zealand**

BSH Home Appliances Ltd.  
Unit F 2, 4 Orbit Drive  
Mairangi Bay  
Auckland 0632  
Tel.: 09 477 0492  
Fax: 09 477 2647  
mailto:bshnz-cs@bshg.com  
www.bosch-home.co.nz

**PL Polska, Poland**

BSH Sprzęt Gospodarcstwa  
Domowego sp. z o.o.  
Al. Jerozolimskie 183  
02-222 Warszawa  
Centrala Serwisu  
Tel.: 801 191 534  
Fax: 022 572 7709  
mailto:Serwis.Fabryczny@bshg.com  
www.bosch-home.pl

**PT Portugal**

BSHP Electrodomésticos Lda.  
Rua Alto do Montijo, nº 15  
2790-012 Carnaxide  
Tel.: 707 500 545\*  
Fax: 214 250 701  
mailto:bosch.electrodomesticos.pt@  
bshg.com  
www.bosch-home.pt

\*(PT 0,10 €/min., Mobile 0,25 €/min)

**RO România, Romania**

BSH Electrocasnice srl.  
Sos. Bucuresti-Ploiesti,  
nr. 19-21, sect.1  
13682 Bucuresti  
Tel.: 021 203 9748  
Fax: 021 203 9733  
mailto:service.romania@bshg.com  
www.bosch-home.ro

**RU Russia, Россия**

ООО "БСХ Бытовая техника"  
Сервис от производителя  
Малая Калужская 19/1  
119071 Москва  
тел.: 495 737 2961  
mailto:mok-kdhl@bshg.com  
www.bosch-home.com

**SA Kingdom Saudi Arabia,**

المملكة العربية السعودية  
BSH Home Appliances  
Saudi Arabia L.L.C.  
Bin Hamran Commercial Centr.  
6th Floor 603B  
Jeddah 21481  
Tel.: 800 124 1247  
mailto:service.ksa@bshg.com  
www.bosch-home.com/sa

**SE Sverige, Sweden**

BSH Hushållsapparater AB  
Landsvägen 32  
169 29 Solna  
Tel.: 0771 11 22 77 local rate  
mailto:Bosch-Service-SE@  
bshg.com  
www.bosch-home.se

**SG Singapore, 新加坡**

BSH Home Appliances Pte. Ltd.  
TECHPLACE I and  
Mo Kio Avenue 10  
Block 4012 #01-01  
569628 Singapore  
Tel.: 6751 5000  
Fax: 6751 5005  
mailto:bshsgp.service@bshg.com  
www.bosch-home.com.sg

**SI Slovenija, Slovenia**

BSH Hišni aparati d.o.o.  
Litostrajska 48  
1000 Ljubljana  
Tel.: 01 583 07 01  
Fax: 01 583 08 89  
mailto:informacije.servis@  
bshg.com  
www.bosch-home.com/si

**SK Slovensko, Slovakia**

BSH domácí spotřebiče s.r.o.  
Organizačná zložka Bratislava  
Galvaniho 17/C  
821 04 Bratislava  
Tel.: 02 44 45 20 41  
mailto:opravy@bshg.com  
www.bosch-home.com/sk

**TR Türkiye, Turkey**

BSH Ev Aletleri Sanayi  
ve Ticaret A.S.  
Fatih Sultan Mehmet Mahallesi  
Balkan Caddesi No: 51  
34771 Ümraniye, İstanbul  
Tel.: 0 216 444 6333\*  
Fax: 0 216 528 9188  
mailto:careline.turkey@bshg.com  
www.bosch-home.com/tr  
\*Çağrı merkezini sabit hatlardan aramanın  
bedelli şehir içi ücretlendirme, Cep  
telefonlarından ise kullanılan tarifeye göre  
değişkenlik göstermektedir

**TW Taiwan, 台灣**

Achelis Taiwan Co. Ltd.  
4th floor, No. 112 Sec 1  
Chung Hsiao E Road  
Taipei ROC 100  
Tel.: 02 2321 6222  
mailto:Bosch@achelis.com.tw

**UA Ukraine, Україна**

ТОВ "БСХ Побутова Техніка"  
тел.: 044 490 2095  
mailto:bsh-service.ua@bshg.com  
www.bosch-home.com.ua

**XK Kosovo**

NTP GAMA  
Rruga Mag Prishtine-Ferizaj  
70000 Ferizaj  
Tel.: 0290 321 434  
mailto:a\_service@  
gama-electronics.com

**XS Srbija, Serbia**

BSH Kućni aparati d.o.o.  
Milutina Milankovića 11<sup>a</sup>  
11070 Novi Beograd  
Tel.: 011 205 23 97  
Fax: 011 205 23 89  
mailto:informacije.servis-sr@  
bshg.com  
www.bosch-home.rs

**ZA South Africa**

BSH Home Appliances (Pty) Ltd.  
15th Road Randjespark  
Private Bag X36, Randjespark  
1685 Midrand – Johannesburg  
Tel.: 086 002 6724  
Fax: 086 617 1780  
mailto:applianceserviceza@  
bshg.com  
www.bosch-home.com/za



UK +44 (0)844 892 8979

IRL +353 (0)1450 2655

**Customer Service**

**Great Britain**

Bosch Customer Service

Grand Union House

Old Wolverton Road

Milton Keynes MK12 5PT

**[www.bosch-home.co.uk](http://www.bosch-home.co.uk)**



**9000984289**