

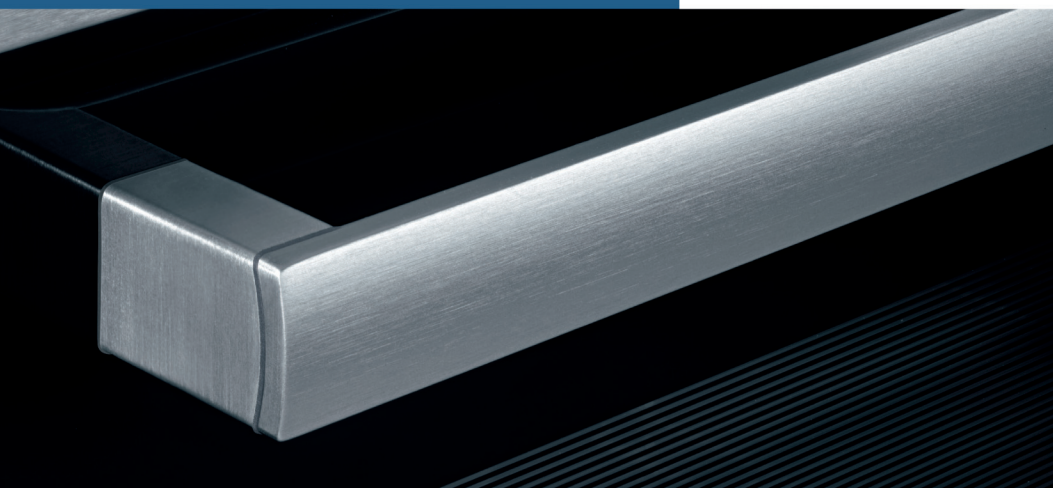

Register your new Bosch now:
www.bosch-home.com/welcome



**Built-in oven
HVA531NS0**



BOSCH

[en] Instruction manual

en Table of contents

Important safety information	3	Troubleshooting	11
Causes of damage	5	Replacing the oven light bulb.....	11
Your new appliance	5	After-sales service	12
Function selector.....	5	E number and FD number	12
Temperature selector	6	Energy and environment tips	12
The electronic clock	6	Saving energy.....	12
Accessories	6	Environmentally-friendly disposal.....	12
Before using the oven for the first time	7	Acrylamide in foodstuffs	12
Setting the clock	7	Tips for using your appliance	13
Baking out the oven	7	Baking	13
Cleaning the accessories.....	7	Roasting and grilling	13
How to operate your oven	7	Tested for you in our cooking studio.....	14
Switching on the oven.....	7		
Operating the electronic clock	7		
Setting the automatic timer	8		
Displaying and changing set values	8		
Care and cleaning	9		
Cleaning agents	9		
Removing and installing the door panels	9		
Removing and fitting the appliance door.....	10		
Removing and inserting the hook-in racks	11		

Additional information on products, accessories, replacement parts and services can be found at www.bosch-home.com and in the online shop www.bosch-eshop.com

Important safety information

Read these instructions carefully. Only then will you be able to operate your appliance safely and correctly. Retain the instruction manual and installation instructions for future use or for subsequent owners.

This appliance is only intended to be fully fitted in a kitchen. Observe the special installation instructions.

Check the appliance for damage after unpacking it. Do not connect the appliance if it has been damaged in transport.

Only a licensed professional may connect appliances without plugs. Damage caused by incorrect connection is not covered under warranty.

This appliance is intended for domestic use only. The appliance must only be used for the preparation of food and drink. The appliance must be supervised during operation. Only use this appliance indoors.

This appliance is intended for use up to a maximum height of 2000 metres above sea level.

This appliance may be used by children over the age of 8 years old and by persons with reduced physical, sensory or mental capabilities or by persons with a lack of experience or knowledge if they are supervised or are instructed by a person responsible for their safety how to use the appliance safely and have understood the associated hazards.

Children must not play with, on, or around the appliance. Children must not clean the appliance or carry out general maintenance unless they are at least 8 years old and are being supervised.

Keep children below the age of 8 years old at a safe distance from the appliance and power cable.

Always slide accessories into the cooking compartment correctly. See "*Description of accessories*" in the instruction manual.

Risk of fire!

- Combustible items stored in the cooking compartment may catch fire. Never store combustible items in the cooking compartment. Never open the appliance door if there is smoke inside. Switch off the appliance and unplug it from the mains or switch off the circuit breaker in the fuse box.
- A draught is created when the appliance door is opened. Greaseproof paper may come into contact with the heating element and catch fire. Do not place greaseproof paper loosely over accessories during preheating. Always weight down the greaseproof paper with a dish or a baking tin. Only cover the surface required with greaseproof paper. Greaseproof paper must not protrude over the accessories.

Risk of burns!

- The appliance becomes very hot. Never touch the interior surfaces of the cooking compartment or the heating elements. Always allow the appliance to cool down. Keep children at a safe distance.
- Accessories and ovenware become very hot. Always use oven gloves to remove accessories or ovenware from the cooking compartment.
- Alcoholic vapours may catch fire in the hot cooking compartment. Never prepare food containing large quantities of drinks with a high alcohol content. Only use small quantities of drinks with a high alcohol content. Open the appliance door with care.

Risk of scalding!

- The accessible parts become hot during operation. Never touch the hot parts. Keep children at a safe distance.
- When you open the appliance door, hot steam may escape. Open the appliance door with care. Keep children at a safe distance.
- Water in a hot cooking compartment may create hot steam. Never pour water into the hot cooking compartment.

Risk of injury!

Scratched glass in the appliance door may develop into a crack. Do not use a glass scraper, sharp or abrasive cleaning aids or detergents.

Risk of electric shock!

- Incorrect repairs are dangerous. Repairs may only be carried out by one of our trained after-sales engineers. If the appliance is faulty, unplug the mains plug or switch off the fuse in the fuse box. Contact the after-sales service.
- The cable insulation on electrical appliances may melt when touching hot parts of the appliance. Never bring electrical appliance cables into contact with hot parts of the appliance.
- Do not use any high-pressure cleaners or steam cleaners, which can result in an electric shock.
- When replacing the cooking compartment bulb, the bulb socket contacts are live. Before replacing the bulb, unplug the appliance from the mains or switch off the circuit breaker in the fuse box.
- A defective appliance may cause electric shock. Never switch on a defective appliance. Unplug the appliance from the mains or switch off the circuit breaker in the fuse box. Contact the after-sales service.

Causes of damage

Caution!

- Accessories, foil, greaseproof paper or ovenware on the cooking compartment floor: do not place accessories on the cooking compartment floor. Do not cover the cooking compartment floor with any sort of foil or greaseproof paper. Do not place ovenware on the cooking compartment floor if a temperature of over 50 °C has been set. This will cause heat to accumulate. The baking and roasting times will no longer be correct and the enamel will be damaged.
- Water in a hot cooking compartment: do not pour water into the cooking compartment when it is hot. This will cause steam. The temperature change can cause damage to the enamel.
- Moist food: do not store moist food in the cooking compartment when it is closed for prolonged periods. This will damage the enamel.

- Fruit juice: when baking particularly juicy fruit pies, do not pack the baking tray too generously. Fruit juice dripping from the baking tray leaves stains that cannot be removed. If possible, use the deeper universal pan.
- Cooling with the appliance door open: only allow the cooking compartment to cool when it is closed. Even if the appliance door is only open a little, front panels of adjacent units could be damaged over time.
- Very dirty door seal: If the door seal is very dirty, the appliance door will no longer close properly when the appliance is in use. The fronts of adjacent units could be damaged. Always keep the door seal clean.
- Appliance door as a seat, shelf or worktop: Do not sit on the appliance door, or place or hang anything on it. Do not place any cookware or accessories on the appliance door.
- Inserting accessories: depending on the appliance model, accessories can scratch the door panel when closing the appliance door. Always insert the accessories into the cooking compartment as far as they will go.
- Carrying the appliance: do not carry or hold the appliance by the door handle. The door handle cannot support the weight of the appliance and could break.

Your new appliance

Get to know your appliance. You will find information on the control panel, the oven, types of heating and accessories.

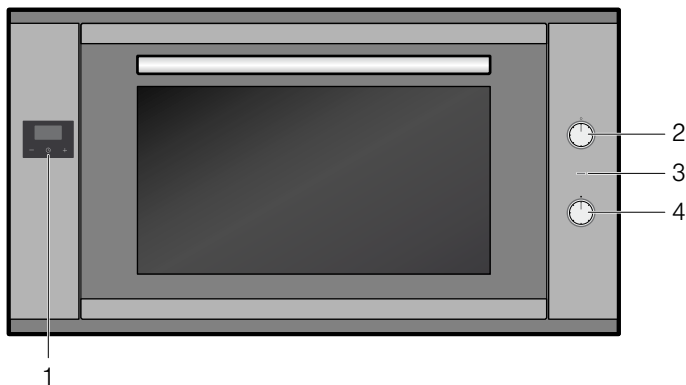

Explanation

1	Electronic clock
2	Function selector
3	Indicator light
4	Temperature selector

Function selector

Use the function selector to set the heating function.

Setting	Use
<input type="radio"/> Off position	The oven is switched off.
<input type="checkbox"/> Top/bottom heating	For cakes, bakes and lean joints. Heat is emitted evenly from the top and bottom.
<input checked="" type="checkbox"/> Hot air	For cakes and pastries on one or two levels. The fan distributes the heat from the ring heating element in the back panel evenly around the cooking compartment.

* Heating function used to determine the energy efficiency class in accordance with EN 50304.

Setting	Use
<input checked="" type="checkbox"/> Hot air eco*	For cakes and pastries on one or two levels. The fan distributes the heat from the ring heating element in the back panel evenly around the cooking compartment. With this heating function, the oven lighting remains switched off.
<input checked="" type="checkbox"/> Air recirculation	For cakes, pastries and fresh pizza on one or two levels. The fan distributes heat from the heating elements evenly around the cooking compartment.
<input checked="" type="checkbox"/> Pizza setting	Quick preparation of frozen products without preheating, e.g. pizza, chips or strudel. The bottom heating element and the ring heating element in the back panel heat up.
<input checked="" type="checkbox"/> Hot air grill	For baking or roasting meat, poultry and whole fish. The fan causes the hot air to circulate around the dish.
<input type="checkbox"/> Full-surface grill	For grilling steaks, sausages, toast and pieces of fish. The whole area below the grill element becomes hot.
<input type="checkbox"/> Centre-area grill	For grilling small amounts of steak, sausages, toast and pieces of fish. The centre part of the grill heating element becomes hot.
<input type="checkbox"/> Bottom heating	For extending the cooking time. The heat is emitted only from below.
<input checked="" type="checkbox"/> Lighting	The oven lighting is switched on.

* Heating function used to determine the energy efficiency class in accordance with EN 50304.

Note: When you set the heating function, the oven light in the cooking compartment switches on.

Note: With the "Hot air eco" heating function, the oven lighting remains switched off.

Temperature selector

Set the temperature or grill setting using the temperature selector.

Setting	Meaning	
●	Off position	The oven does not heat up.
50-250	Temperature range	The temperature in the cooking compartment in °C.

The indicator light is lit when the oven is heating up. It goes out during pauses in heating.

The electronic clock

You can use the electronic clock to control your oven. You can therefore preselect, for example, the time at which the oven is to switch on or at which time the automatic timer is to end the baking or cooking process. The electronic clock can also be used as a timer.

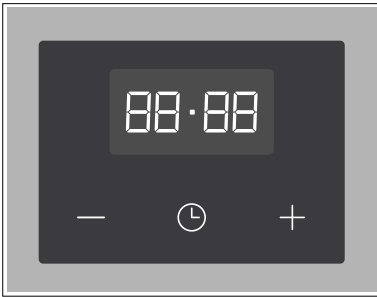

Function buttons for the electronic clock

Symbol	Meaning	Use
🕒	Electronic clock	Sets the cooking time or the time
-	Minus	Reduces the cooking time or the time
+	Plus	Increases the cooking time or the time

Accessories

The accessories can be inserted into the cooking compartment at 4 different levels. Always insert them as far as they will go so that the accessories do not touch the door panel. Ensure that the accessories have always been inserted into the cooking compartment correctly.

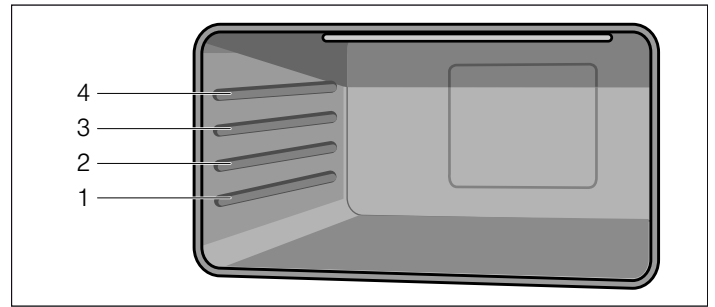

The pull-out rails allow you to pull accessories out completely.

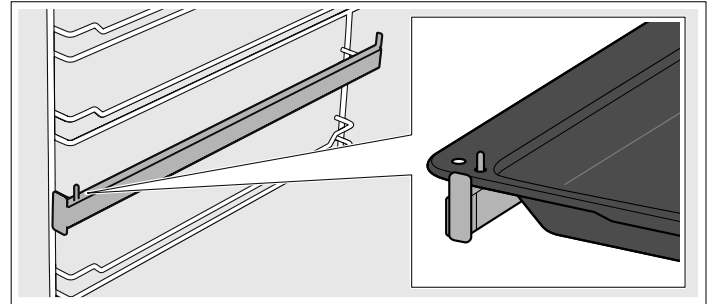

You can pull out the accessories two thirds of the way without them tipping. This allows dishes to be removed easily.

The accessories may become deformed when they become hot. As soon as they have cooled down, the deformation disappears with no effect on the function.

You can buy accessories from the after-sales service, from specialist retailers or online.

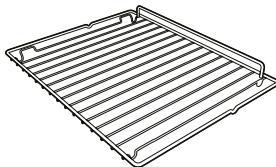
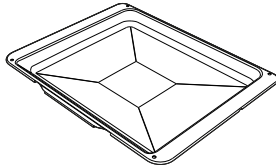
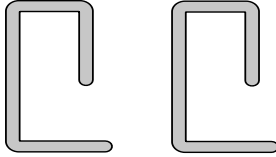
Accessories	Description
	Baking and roasting shelf For ovenware, cake tins, joints, grilled items, frozen meals.
	Enamel baking tray For moist cakes, pastries, frozen meals and large roasts. Can also be used as a drip tray to collect run-off fat.
	Locking pins For locking the hinges.

Before using the oven for the first time

In this section, you can find out what you must do before using your appliance to prepare food for the first time. Read the *Safety information* section beforehand.

Remove the appliance packaging and dispose of it appropriately.

Setting the clock

After the appliance has been connected to the mains or after a power cut, three zeros and the "A" symbol flash on the display.

1. Press the  button until the dot flashes on the display.
2. Set the current time with the "+" and "-" buttons.

After seven seconds, the time that has been set is adopted.

Note: To change the set time, press the "+" and "-" buttons until the dot flashes on the display. Then set the current time with the "+" and "-" buttons.

Baking out the oven

Precleaning the oven

1. Remove the accessories and the hook-in racks from the cooking compartment.
2. Completely remove any leftover packaging, e.g. small pieces of polystyrene, from the cooking compartment.
3. Some parts are covered with a protective film. Remove this scratch protection film.
4. Clean the outside of the appliance with a soft, damp cloth.
5. Clean the cooking compartment with hot soapy water.

Heating up the oven

To remove the new cooker smell, heat up the oven when it is empty and closed.

1. Turn the function selector to the Top/bottom heating operating mode.
2. Turn the temperature selector to the maximum temperature.
3. Switch the oven off after 40 minutes.

Note: When the appliance is heating up for the first time, you may hear crackling noises coming from the oven.

Recleaning the oven

1. Clean the cooking compartment with hot soapy water.
2. Refit the hook-in racks.

Cleaning the accessories

Before using the accessories, clean them thoroughly using a cloth and warm soapy water.

How to operate your oven

Pop-out operating controls

The function selector and the temperature selector can be popped out. Press the operating control in question to pop it in or out.

Switching on the oven

1. Use the function selector to set the heating function.
2. Use the temperature selector to set the temperature.

The oven begins to heat up.

Switching off the oven

Turn the function selector and temperature selector to the off position.

Changing settings



The heating function and temperature or grill setting can be changed at any time using their respective selectors.

Heating up

To heat up the cooking compartment as quickly as possible, use the "Circulated air" heating function. If the set temperature has been reached (indicator light has gone out), set the required heating function.

Operating the electronic clock

In addition to the clock time and remaining time, the following symbols may appear on the display:

Symbol	Meaning
•	Dot between the displayed hours and minutes. Flashes when it is possible to set the clock time.
	Timer Displays the operating statuses for the timer.
A	Automatic mode Displays the operating statuses for Automatic mode.
	Operating readiness If this symbol is displayed, the oven is ready to use.

Setting the time on the clock

After the appliance has been connected to the mains or after a power cut, three zeros and the "A" symbol flash on the display.



1. Press the  button until the dot flashes on the display.
2. Set the current time with the "+" and "-" buttons.

After seven seconds, the time that has been set is adopted.



Note: To change the set time, press the "+" and "-" buttons until the dot flashes on the display. Then set the current time with the "+" and "-" buttons.

Setting the timer



The timer has no influence on the functions of the oven. The duration of the timer can be set to between 1 minute and 23 hours and 59 minutes.

1. Press the  button until the  symbol flashes on the display and three zeros are displayed.
2. Set the required cooking time with the "+" and "-" buttons.
An audible signal sounds once the time has elapsed.

Notes

- To change the remaining time, press the  button until the  symbol flashes on the display. Then change the remaining time with the "+" and "-" buttons.
- To cancel the setting, press the  button until the symbol flashes on the display. Then press the "+" and "-" buttons at the same time.

Switching off the acoustic signal

Press the  button until the  symbol disappears.

After seven minutes, the signal switches off automatically.

Changing the audible signal



Three different audible signals are available.

1. Press the "+" and "-" buttons simultaneously.
2. Press the  button.
The current audible signal is shown in the display panel, e.g. "Tone 1".
3. Press the "-" button to select a different audible signal.

Setting the automatic timer



The electronic clock can be used to switch the oven on or off automatically.

Automatic switch-off

1. Press the  button until the  symbol flashes on the display and three zeros are displayed.
2. Press the  function button again until "dur" and "0.00" flash alternately on the display panel and the "A" symbol flashes.
3. Set the cooking time with the "+" and "-" buttons.
The cooking time can be set to between 1 minute and 10 hours.
4. Set the required heating function and temperature.
The oven starts and the "A" symbol and the current clock time appear on the display panel.





The cooking time has elapsed

An audible signal sounds, the  symbol disappears from the display panel and the "A" symbol flashes.

1. Switch off the temperature selector and function selector.
2. Press the  button until the  symbol appears.
The oven switches back to manual mode.



Automatic switch-on and switch-off

Baking or roasting starts for the set duration at a later time which you chose.

1. Press the  button until the  symbol flashes on the display and three zeros are displayed.
2. Press the  function button again until "dur" and "0.00" flash alternately on the display panel and the "A" symbol flashes.
The current time may be 17:30, for example.
3. Set the cooking time (e.g. 1 hour) with the "+" and "-" buttons.
The cooking time can be set to between 1 minute and 10 hours.
4. Press the  function button again until "End" and the switch-off time "18:30" (i.e. the current time plus the set cooking time) flash alternately on the display panel.
5. Set the switch-off time (e.g. 19:30) using the "+" and "-" buttons.
The switch-off time can be set to up to 23 hours and 59 minutes.
6. Set the required heating function and temperature.
The  symbol disappears from the display panel.
In this example, the oven starts at 18:30 and switches off again at 19:30.

The cooking time has elapsed



An audible signal sounds, the  symbol disappears from the display panel and the "A" symbol flashes.

1. Switch off the temperature selector and function selector.
2. Press the  button until the  symbol appears.
The oven switches back to manual mode.

Displaying and changing set values





The set values and the remaining time for the various operating modes of the electronic clock can be viewed and changed on the display panel at any time.

Displaying the remaining time for the timer

Press the  button until the  symbol flashes on the display.

The remaining time appears on the display and can be changed with the "+" and "-" buttons.

Displaying and changing the cooking time and switch-off time.

1. Press the  button until the  symbol flashes on the display panel.
2. Press the  button again until "dur" and the remaining cooking time flash alternately on the display panel and the "A" symbol flashes.
The cooking time can be changed with the "+" and "-" buttons. Press the "+" and "-" buttons at the same time to switch off the automatic timer.
3. Press the  button again until "End" and the set switch-off time flash alternately on the display panel.
The switch-off time can be changed with the "+" and "-" buttons. Press the "+" and "-" buttons at the same time to switch off the automatic timer.

Care and cleaning

With good care and cleaning, your oven will remain clean and fully-functioning for a long time to come. Here we will explain how to maintain and clean your oven correctly.

Notes

- Slight differences in the colours on the front of the oven are caused by the use of different materials, such as glass, plastic and metal.
- Shadows on the door panel which look like streaks, are caused by reflections made by the oven light.
- Enamel is baked on at very high temperatures. This can cause some slight colour variations. This is normal and does not affect their function. The edges of thin trays cannot be completely enamelled. As a result, these edges can be rough. This will not impair the anti-corrosion protection.

⚠ Risk of electric shock!

Do not use any high-pressure cleaners or steam cleaners, which can result in an electric shock.

⚠ Risk of burns!

The appliance becomes very hot. Never touch the interior surfaces of the cooking compartment or the heating elements. Always allow the appliance to cool down. Keep children at a safe distance.

Cleaning agents

Damage to the various different surfaces caused by using the wrong cleaning agent can be avoided by observing the following instructions.

Do not use

- harsh or abrasive cleaning agents
- cleaning agents with high concentrations of alcohol
- hard scouring pads and sponges
- high-pressure cleaners or steam cleaners.

Wash new sponge cloths thoroughly before use.

Area	Cleaning agent
Appliance exterior	Hot soapy water: Clean with a dish cloth and dry with a soft cloth. Do not use glass cleaner or a glass scraper.
Stainless steel	Hot soapy water: Clean with a dish cloth and dry with a soft cloth. Remove flecks of limescale, grease, starch and albumin (e.g. egg white) immediately. Corrosion can form under such flecks. Special stainless steel cleaning products suitable for hot surfaces are available from our after-sales service or from specialist retailers. Apply a very thin layer of the cleaning product with a soft cloth.
Aluminium and plastic	Glass cleaner: Clean with a soft cloth.

Area	Cleaning agent
Enamel surfaces (smooth surfaces)	To facilitate cleaning, you can switch on the interior lighting and, if necessary, detach the appliance door. Apply commercially available washing-up liquid or a vinegar solution with a soft, damp cloth or chamois; dry with a soft cloth. Soften any burnt-on food residues with a damp cloth and washing-up liquid. For stubborn dirt, we recommend using oven cleaning gel. This can be applied directly to the affected area. Leave the cooking compartment open to dry after cleaning.
Door panels	Glass cleaner: Clean with a soft cloth. Do not use a glass scraper.
Glass cover for the oven light	Hot soapy water: Clean with a dish cloth.
Seal Do not remove.	Hot soapy water: Clean with a dish cloth. Do not scour.
Rails	Hot soapy water: Soak and clean with a dish cloth or brush.
Accessories	Hot soapy water: Soak and clean with a dish cloth or brush.

Removing and installing the door panels

To facilitate cleaning, you can remove the glass panels from the oven door.

Removing the door panels

1. Open the oven door fully.
2. Lock both hinges on the left and right using the locking pin.

Note: The locking pins must be fully inserted into the holes in the hinges.

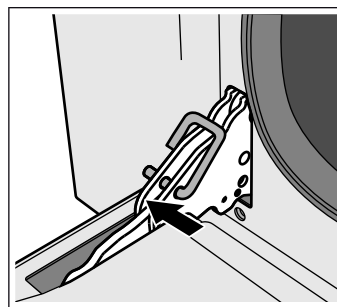

3. Lift the bottom of the inner panel slightly until the fastening pins come out of the holder (1).
4. Carefully lift the top of the inner panel until the fastening pins come out of the holder (2).

Caution!

When lifting the inner panel, the middle panel may stick to the inner panel. Make sure that the middle panel does not fall.

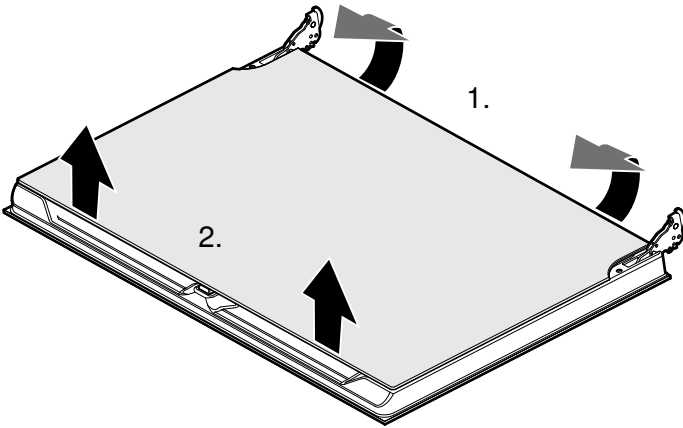

- 5. Remove the inner panel.
- 6. Remove the middle panel.

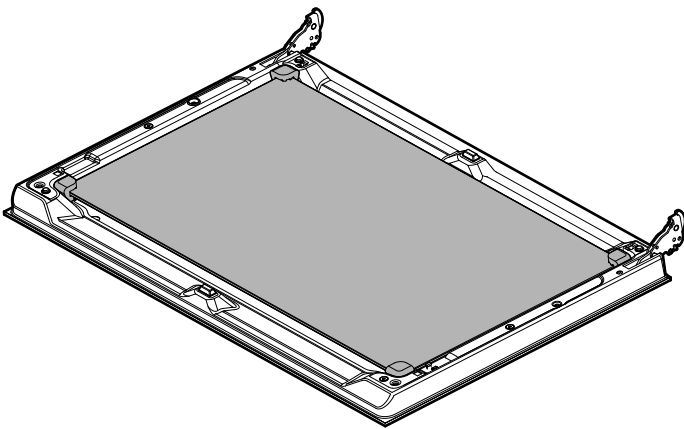

Note: The middle panel is kept in place with rubber bushings rather than retaining pins.

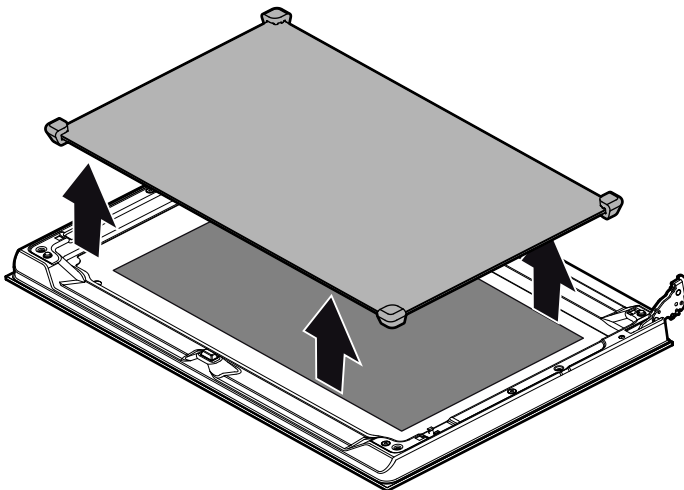

Clean the panels with glass cleaner and a soft cloth.

⚠ Risk of injury!

Scratched glass in the appliance door may develop into a crack. Do not use a glass scraper, sharp or abrasive cleaning aids or detergents.

Fitting the door panels

- 1. Reinsert the middle panel.

Notes

- If the Low-E symbol can be read, the middle panel is inserted correctly.
- Make sure that the panel is seated correctly. All rubber mounts must lay flat against the outer panel.

- 2. Reinsert the inner panel.

Note: All four fastening pins must engage in the holders provided for them.

- 3. Remove the locking pins and close the oven door.

Removing and fitting the appliance door

If the oven is very heavily soiled, the oven door can be removed for easier cleaning. Normally, however, this is not necessary.

Removing the appliance door

- 1. Open the oven door fully.
- 2. Lock both hinges on the left and right using the locking pin (a).
- Note:** The locking pins must be fully inserted into the holes in the hinges.
- 3. Grip the oven door on either side with both hands and close the oven door by approx. 30° (b).

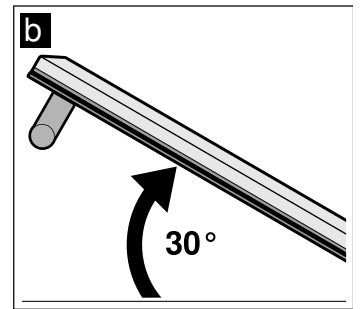
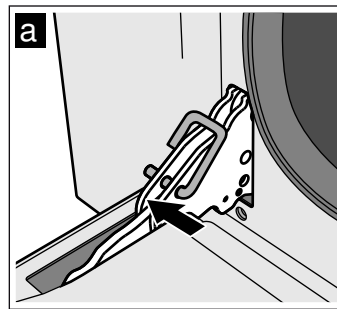

- 4. Raise the oven door slightly and pull it out.

Note: Do not fully close the oven door. The hinges could become bent and the enamel could be damaged.

Fitting the appliance door

- 1. Grip the oven door on either side with both hands.
- 2. Slide the hinges into the slots in the oven (a).

Note: The notch below the hinges must engage into the frame of the oven (b).

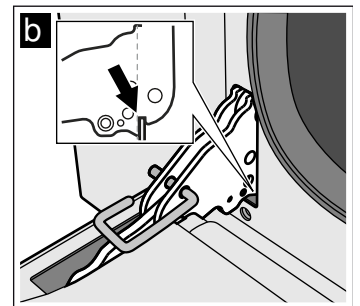
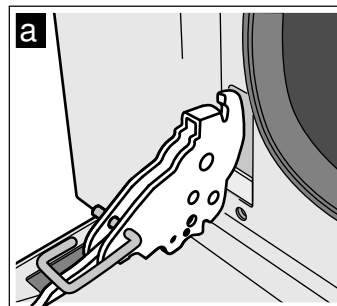

- 3. Lower the door downwards.
- 4. Remove the locking pins.

⚠ Risk of injury!

Do not reach into the hinge if the oven door falls out unintentionally or a hinge snaps closed. Call after-sales service.

Removing and inserting the hook-in racks

You can remove the hook-in racks for easier cleaning.

Removing the hook-in racks

The hook-in racks are each fixed to the side panels of the cooking compartment at three points.

1. Grip the front of the hook-in rack and pull it to the middle of the cooking compartment.
The front hook of the hook-in rack will release from the hole.
2. Fold out the hook-in rack further and pull it from the rear holes of the side panel.
3. Hold the catalytic cooking compartment panel in place.

4. Remove the hook-in rack from the cooking compartment.

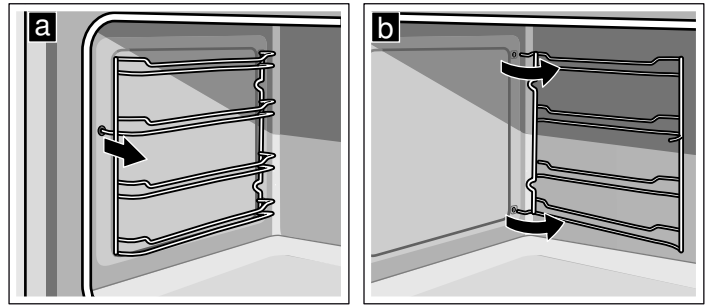

Inserting the hook-in rack

1. Hold the catalytic cooking compartment panel in place.
2. Insert the hooks of the hook-in rack into the rear holes in the side panel.
3. Press the front hook of the hook-in rack into the hole.

Troubleshooting

Malfunctions often have simple explanations. Please read the following notes before calling the after-sales service.

Problem	Possible cause	Notes/remedy
The appliance does not work.	Circuit breaker faulty.	Look in the fuse box and check that the circuit breaker for the cooker is in working order.
	Power cut	Check whether the kitchen light works.
The oven cannot be switched off.	The electronics are faulty.	Switch off the circuit breaker. Contact the after-sales service.
The clock display flashes.	Power cut	Reset the clock.
The oven does not heat up.	Circuit breaker faulty.	Check the circuit breaker and replace if necessary.
	The function selector has not been set.	Set the function selector.
The door glass is broken.		Switch off the appliance. Contact the after-sales service.
Fruit juice or albumen stains on enamelled surfaces.	Moist cake or meat juices.	Harmless change in the enamel, cannot be removed.

⚠ Risk of electric shock!

Incorrect repairs are dangerous. Repairs may only be carried out by one of our trained after-sales engineers.

Incorrect repairs may result in significant risk to the user.

Replacing the oven light bulb

If the oven light bulb fails, it must be replaced. Replacement heat-resistant bulbs can be obtained from the after-sales service or from specialist retailers. Please specify the E number and FD number of your appliance. Do not use any other type of bulb.

⚠ Risk of electric shock!

When replacing the cooking compartment bulb, the bulb socket contacts are live. Before replacing the bulb, unplug the appliance from the mains or switch off the circuit breaker in the fuse box.

1. Allow the cooking compartment to cool down.
2. Open the appliance door.
3. Place a tea towel in the cooking compartment to prevent damage.
4. Remove the hook-in racks.
5. Remove the glass cover. To do this, open the glass cover at the front with your hand. Should you experience difficulties removing the glass cover, use a spoon to help.
6. Remove the oven light bulb.

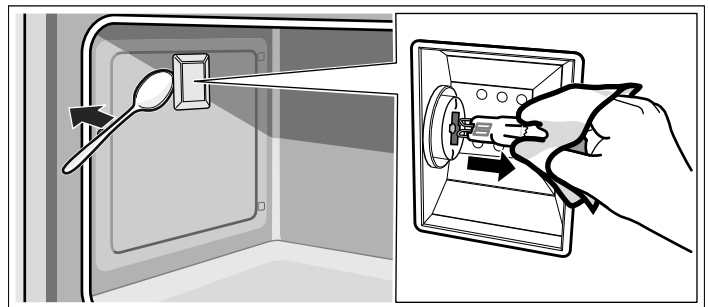

7. Replace the oven light bulb with a bulb of the same type:
Voltage: 230 V;
Power: 40 W;
Fitting: G9;
Temperature resistance: 300 °C
8. Refit the glass cover for the oven light bulb.
9. Refit the hook-in racks.
10. Remove the tea towel.
11. Switch the circuit breaker back on.
12. Check that the oven lighting is working again.

After-sales service

Our after-sales service is there for you if your appliance needs to be repaired. We will always find the right solution in order to avoid unnecessary visits from a service technician.

E number and FD number

When calling us, please give the product number (E no.) and the production number (FD no.) so that we can provide you with the correct advice. To find the identification plate with the numbers, open the oven door and look at the front of the bottom of the cooking compartment. To save time, you can make a note of the number of your appliance and the telephone number of the after-sales service in the space below, should it be required.

E no.	FD no.
After-sales service 	

Please note that there will be a fee for a visit by a service technician in the event of a malfunction, even during the warranty period.

You can find the contact information for your nearest after-sales service in all countries here or in the attached after-sales service directory.

Repair order and advice if faults occur

- A** 0810 240 260
D 01801 22 33 55
(€0.039/min. from a landline,
max. €0.42/min. from a mobile phone)
CH 0848 840 040

Put your trust in the expertise of the manufacturer. You can then be sure that the repair work is carried out by trained service technicians who can supply original spare parts for your household appliance.

Energy and environment tips

Here you can find tips on how to save energy when baking and roasting and how to dispose of your appliance properly.

Saving energy

- Only preheat the oven when it is specified in the recipe that you should do so.
- Use dark, black lacquered or enamelled baking tins. They absorb the heat particularly well.
- Open the oven door as infrequently as possible while you are cooking, baking or roasting.
- It is best to bake several cakes one after the other. The oven is still warm. This reduces the baking time for the second cake. You can also place two loaf tins next to each other.
- For longer cooking times, you can switch the oven off 10 minutes before the end of the cooking time and use the residual heat to finish cooking.

Environmentally-friendly disposal

Dispose of packaging in an environmentally-friendly manner.



This appliance is labelled in accordance with European Directive 2012/19/EU concerning used electrical and electronic appliances (waste electrical and electronic equipment - WEEE). The guideline determines the framework for the return and recycling of used appliances as applicable throughout the EU.

Acrylamide in foodstuffs

Acrylamide is mainly produced in grain and potato products prepared at high temperatures, such as potato crisps, chips,

toast, bread rolls, bread or fine baked goods (biscuits, gingerbread, cookies).

Tips for keeping acrylamide to a minimum when preparing food

General	<ul style="list-style-type: none">■ Keep cooking times to a minimum.■ Cook meals until they are golden brown, but not too dark.■ Large, thick pieces of food contain less acrylamide.
Baking	With Top/bottom heating max. 200 °C. With 3D hot air or hot air max. 180 °C.
Biscuits	With Top/bottom heating max. 190 °C. With 3D hot air or hot air max. 170 °C. Egg or egg yolk reduces the production of acrylamide.
Oven chips	Spread out a single layer evenly on the baking tray. Cook at least 400 g at once on a baking tray so that the chips do not dry out.

Tips for using your appliance

Here you will find a selection of tips on ovenware and preparation methods.

Notes

- Use the accessories provided. Additional accessories may be obtained as special accessories from specialist retailers or from the after-sales service.
Before using the oven, remove any unnecessary accessories and ovenware from the cooking compartment.
- Always use an oven cloth or oven gloves when taking accessories or cookware out of the cooking compartment.

Baking tips

How to establish whether sponge cake is baked through.	Approx. 10 minutes before the end of the baking time stated in the recipe, insert a cocktail stick into the cake at its deepest point. If no cake mixture sticks to the wood, the cake is ready.
The cake collapses.	Use less fluid next time or set the oven temperature 10 degrees lower. Note the stirring times indicated in the recipe.
The cake has risen high in the middle and less around the edges.	Do not grease the sides of the springform cake tin. After baking, carefully loosen the cake using a knife.
The cake is too dark on the top.	Place it lower in the oven, select a lower temperature and bake the cake for a little longer.
The cake is too dry.	When it is done, make small holes in the cake using a cocktail stick. Then drizzle fruit juice or an alcoholic drink over it. Next time, set the temperature 10 degrees higher and reduce the baking time.
The bread or cake (e.g. cheesecake) looks good but is sticky on the inside (soggy with wet streaks).	Next time, use less liquid and bake at a lower temperature for slightly longer. For cakes with a moist topping, bake the base first. Sprinkle it with almonds or bread crumbs and then place the topping on top. Take care to follow recipes and baking times.
The pastries are not evenly browned.	Select a slightly lower temperature to ensure that the cake is baked more evenly. Excess greaseproof paper can affect the air circulation. Always cut the greaseproof paper to suit the size of the baking tray.
The bottom of a fruit flan is too light.	Place the cake one level lower the next time.
The fruit juice overflows.	Next time, use the deeper universal pan, if you have one.
Small baked items made out of yeast dough stick to one another during baking.	There should be a gap of approx. 2 cm around each item. This gives enough space for the baked items to expand and turn brown on all sides.
Condensation forms when you bake moist cakes.	Baking may create water vapour, which escapes above the door. The steam may settle and form water droplets on the control panel or on the fronts of adjacent units. This is a natural process.

Roasting and grilling

Ovenware

You may use any heat-resistant ovenware. Always place the ovenware in the middle of the wire rack. The enamelled baking tray is also suitable for large roasts.

Roasting tips

- A lower temperature produces more even browning.
- Depending on the size of the joint, add 2 or 3 tablespoons of liquid to lean meat and 8 to 10 tablespoons of liquid to pot roasts.
- When cooking duck or goose, pierce the skin on the underside of the wings to allow the fat to run out.
- Poultry will turn out particularly crispy and brown if you baste it towards the end of the roasting time with butter, salted water or orange juice.
- Turn pieces of meat halfway through the cooking time.
- When the roast is ready, turn off the oven and allow it to rest for an additional 10 minutes. This will allow the meat juices to distribute themselves better inside the roast.

Baking

Baking tins

- Use light-coloured baking tins and trays wherever possible.
- Always place the baking tins on the middle of the baking and roasting wire rack.

- When roasting large pieces of meat, you may find that the amount of steam and condensation on the oven door is more than usual. This is a normal occurrence which has no effect on the oven's performance. Once roasting is complete, dry the oven door and window with a cloth.
- If you are roasting on the wire rack, insert the enamelled baking tray into shelf position 1 to collect the drips of fat.

Grilling tips

- If possible, grill items should be of equal thickness. They should be at least 2 to 3 cm thick. This ensures that they brown evenly while also remaining succulent.
- Place the food to be grilled in the centre of the wire rack. Pour a little water into the enamelled baking tray and insert this into the shelf position underneath the grill to collect the drips of fat. Never place it on the cooking compartment floor.
- Drizzle some oil over the food to be grilled before you place it on the wire rack under the grill.
- If the food to be grilled is thin, turn it over halfway through grilling; if it is thick, turn it over several times during grilling. Use tongs when turning the food to avoid piercing it and, in the case of meat, to keep the meat juices inside the meat.
- Dark meats such as lamb and beef brown better and more quickly than light meats such as pork and veal.

Roasting tips

How can you tell when the roast is ready?	Use a meat thermometer (available from specialist retailers) or carry out a "spoon test". Press down on the roast with a spoon. If it feels firm, it is ready. If the spoon can be pressed in, it needs to be cooked for a little longer.
The roast is too dark and the crackling is burnt in places.	Check the shelf position and temperature.
The roast looks good but the juices are burnt.	Next time, use a smaller roasting dish and add more liquid.
The roast looks good, but the juices are too clear and watery.	Next time, use a larger roasting dish and add less liquid.

Tested for you in our cooking studio.

Here, you can find a selection of dishes and the ideal settings for them. We will show you which type of heating, temperature and shelf position are best suited for your dish.

Notes

- The times specified in the tables are only guidelines. They will depend on the quality and composition of the food.
- Use the accessories provided. Additional accessories may be obtained as optional accessories from specialist retailers or from the after-sales service.
Before using the oven, remove any unnecessary accessories and ovenware from the cooking compartment.
- Always use an oven cloth or oven gloves when taking hot accessories or cookware out of the cooking compartment.

All values refer to a preheated oven.

Dish	Weight (kg)	Shelf position	Type of heating	Temperature in °C	Cooking time in minutes
Lasagne	3-4	1		200-230	50-60
Pasta bake	2	1		220-230	40-45
Joint of veal	1.5	2		180-190	70-80
Pork loin	1	2		180-190	50-60
Joint of hare	1.5	2		180-190	70-80
Grilled chicken	1	2		180-190	50-60
Grilled chicken	2	2		180-190	80-90
Sausage	1	3		max.	7-9 first side 5-6 second side
Pork chop	2	4		max.	12-15 first side 5-7 second side
Fresh fish	1.5	2		160-170	50-60
Fresh pizza	2	1		max.	9-11
Bread	2	2		190-200	40-50
Sponge cake	1	2		150-160	50-60
Jam tarts	1	2		160-170	40-50
Brioche	1	2		160-170	25-30
Muffins	x 15, 30 g each	2		170	25



Robert Bosch Hausgeräte GmbH

Carl-Wery-Straße 34

81739 München

Germany

www.bosch-home.com



9000971545

960701