



Steam oven

















[en] INSTRUCTION MANUAL

C17DR02.0B





# Table of contents

	<b>Intended use</b> . . . . .	<b>4</b>		<b>Basic settings</b> . . . . .	<b>18</b>
	<b>Important safety information</b> . . . . .	<b>4</b>		Changing the basic settings . . . . .	18
	<b>Causes of damage</b> . . . . .	<b>5</b>		List of basic settings . . . . .	18
	<b>Environmental protection</b> . . . . .	<b>6</b>		<b>Cleaning</b> . . . . .	<b>19</b>
	Saving energy . . . . .	6		cleaning agents . . . . .	19
	Environmentally-friendly disposal . . . . .	6		Descaling . . . . .	20
	<b>Getting to know your appliance</b> . . . . .	<b>7</b>		Removing and fitting the appliance door . . . . .	21
	Control panel . . . . .	7		Removing and installing the door panels . . . . .	21
	Controls . . . . .	7		Cleaning the rails . . . . .	22
	Main menu . . . . .	7		<b>Trouble shooting</b> . . . . .	<b>23</b>
	Steaming menu . . . . .	8		Fault table . . . . .	23
	Cooking compartment functions . . . . .	8		Replacing the cooking compartment bulb . . . . .	24
				Replacing the glass cover or seals . . . . .	24
				Changing the door seal . . . . .	24
	<b>Accessories</b> . . . . .	<b>8</b>		<b>Customer service</b> . . . . .	<b>25</b>
	Accessories included . . . . .	8		E number and FD number . . . . .	25
	Inserting accessories . . . . .	9		<b>Settings table and tips</b> . . . . .	<b>25</b>
	Optional accessories . . . . .	9		Accessories . . . . .	25
	<b>Before using for the first time</b> . . . . .	<b>10</b>		Ovenware . . . . .	25
	Before using for the first time . . . . .	10		Cooking time and quantity . . . . .	25
	Initial use . . . . .	10		Distributing food evenly . . . . .	25
	Calibrating the appliance and cleaning the cooking compartment . . . . .	10		Pressure-sensitive food . . . . .	25
	Cleaning the accessories . . . . .	11		Cooking a menu . . . . .	25
				Vegetables . . . . .	26
	<b>Operating the appliance</b> . . . . .	<b>11</b>		Side dishes and pulses . . . . .	26
	Switching the appliance on and off . . . . .	11		Poultry and meat . . . . .	27
	Filling the water tank . . . . .	11		Fish . . . . .	27
	Setting and starting the appliance operation . . . . .	12		Soup vegetables, miscellaneous . . . . .	28
	Changing or cancelling the appliance operation . . . . .	13		Dessert, compote . . . . .	28
	After each use . . . . .	13		Reheating food . . . . .	29
				Defrosting . . . . .	29
	<b>Time-setting options</b> . . . . .	<b>14</b>		Dough proving . . . . .	29
	Showing and hiding the time-setting options . . . . .	14		Extracting juice . . . . .	29
	Setting the timer . . . . .	14		Preserving . . . . .	30
	Setting the cooking time . . . . .	14		Frozen products . . . . .	30
	Start delay – "Ready at" . . . . .	14		Test dishes . . . . .	31
	Checking, changing or deleting settings . . . . .	14			
	<b>Programmes</b> . . . . .	<b>15</b>			
	Selecting a programme . . . . .	15			
	Information about the programmes . . . . .	15			
	Table . . . . .	16			
	<b>Childproof lock</b> . . . . .	<b>17</b>			
	Automatic childproof lock . . . . .	17			
	One-time childproof lock . . . . .	17			

---

Additional information on products, accessories, replacement parts and services can be found at [www.neff-international.com](http://www.neff-international.com) and in the online shop [www.neff-eshop.com](http://www.neff-eshop.com)

## Intended use

Read these instructions carefully. Only then will you be able to operate your appliance safely and correctly. Retain the instruction manual and installation instructions for future use or for subsequent owners.

This appliance is only intended to be fully fitted in a kitchen. Observe the special installation instructions.

Check the appliance for damage after unpacking it. Do not connect the appliance if it has been damaged in transport.

Only a licensed professional may connect appliances without plugs. Damage caused by incorrect connection is not covered under warranty.

This appliance is intended for domestic use only. The appliance must only be used for the preparation of food and drink. The appliance must be supervised during operation. Only use this appliance indoors.

This appliance is intended for use up to a maximum height of 2000 metres above sea level.

This appliance may be used by children over the age of 8 years old and by persons with reduced physical, sensory or mental capabilities or by persons with a lack of experience or knowledge if they are supervised or are instructed by a person responsible for their safety how to use the appliance safely and have understood the associated hazards.

Children must not play with, on, or around the appliance. Children must not clean the appliance or carry out general maintenance unless they are at least 8 years old and are being supervised.

Keep children below the age of 8 years old at a safe distance from the appliance and power cable.

Always slide accessories into the cooking compartment the right way round.

→ "Accessories" on page 8

## Important safety information

### Warning – Risk of burns!

- The appliance becomes very hot. Never touch the interior surfaces of the cooking compartment or the heating elements. Always allow the appliance to cool down. Keep children at a safe distance.
- Accessories and ovenware become very hot. Always use oven gloves to remove accessories or ovenware from the cooking compartment.
- Hot steam may escape during operation. Do not touch the ventilation openings. Keep children away.

### Warning – Risk of scalding!

- The accessible parts become hot during operation. Never touch the hot parts. Keep children at a safe distance.
- Water in a hot cooking compartment may create hot steam. Never pour water into the hot cooking compartment.
- When you open the appliance door, hot steam can escape. Steam may not be visible, depending on its temperature. When opening, do not stand too close to the appliance. Open the appliance door carefully. Keep children away.
- The water in the evaporator dish is still hot even after the appliance has been switched off. Do not empty the evaporator dish immediately after switching off the appliance. Allow the appliance to cool down before cleaning it.
- Hot liquid may spill over the sides of the accessory when it is removed from the cooking compartment. Remove hot accessories with care and always wear oven gloves.

### Warning – Risk of injury!

- Scratched glass in the appliance door may develop into a crack. Do not use a glass scraper, sharp or abrasive cleaning aids or detergents.
- Flammable liquids can catch fire in the cooking compartment when it is hot (explosion). Do not fill the water tank with any flammable fluids (e.g. alcoholic drinks). Only fill the water tank with water or with the descaling solution that is recommended by us.

**⚠ Warning – Risk of electric shock!**

- Incorrect repairs are dangerous. Repairs may only be carried out by one of our trained after-sales engineers. If the appliance is faulty, unplug the mains plug or switch off the fuse in the fuse box. Contact the after-sales service.
- The cable insulation on electrical appliances may melt when touching hot parts of the appliance. Never bring electrical appliance cables into contact with hot parts of the appliance.
- Do not use any high-pressure cleaners or steam cleaners, which can result in an electric shock.
- When replacing the cooking compartment bulb, the bulb socket contacts are live. Before replacing the bulb, unplug the appliance from the mains or switch off the circuit breaker in the fuse box.
- A defective appliance may cause electric shock. Never switch on a defective appliance. Unplug the appliance from the mains or switch off the circuit breaker in the fuse box. Contact the after-sales service.

** Causes of damage****Caution!**

- Accessories, foil, greaseproof paper or ovenware on the cooking compartment floor: Do not place accessories on the cooking compartment floor. Do not cover the cooking compartment floor with any sort of foil or greaseproof paper. The cooking compartment floor and the evaporator dish must always be kept clear. A build-up of heat may damage the appliance. Always place ovenware in a perforated cooking container or on a wire rack.
- Aluminium foil in the cooking compartment must not come into contact with the door panel. This could cause permanent discolouration of the door panel.
- Ovenware: Ovenware must be heat and steam resistant.
- Ovenware with areas of rust: Do not use any ovenware which displays areas of rust. Even the smallest spots of rust can lead to corrosion in the cooking compartment.
- Dripping liquids: When steaming with a perforated cooking container, always insert the baking tray, the universal pan or the solid cooking container underneath. Dripping liquid is caught.
- Moisture in the cooking compartment: Over an extended period of time, moisture in the cooking compartment may lead to corrosion. Allow the cooking compartment to dry after use. Do not keep moist food in the closed cooking compartment for extended periods of time. Do not store food in the cooking compartment.
- Extremely dirty seal: If the seal is very dirty, the appliance door will no longer close properly during operation. The fronts of adjacent units could be damaged. Always keep the seal clean.  
→ "Cleaning" on page 19
- Appliance door as a seat, shelf or worktop: Do not sit on the appliance door, or place or hang anything on it. Do not place any cookware or accessories on the appliance door.
- Inserting accessories: depending on the appliance model, accessories can scratch the door panel when closing the appliance door. Always insert the accessories into the cooking compartment as far as they will go.
- Carrying the appliance: do not carry or hold the appliance by the door handle. The door handle cannot support the weight of the appliance and could break.
- Looking after the appliance: The cooking compartment on your appliance is made of high-quality stainless steel. Improper care may lead to corrosion in the cooking compartment. Refer to the care and cleaning instructions in the instruction manual. Remove food residues from the cooking compartment as soon as the appliance has cooled.
- Hot water in the water tank: Hot water can damage the pump. Only fill the water tank with cold water.

- Descaling solution: Do not allow descaling solution to come into contact with the control panel or other sensitive surfaces. These will damage the surfaces. If this does happen, remove the descaling solution immediately with water.
- Cleaning the water tank: Do not clean the water tank in the dishwasher. Otherwise, the water tank will be damaged. Clean the water tank with a soft cloth and standard washing-up liquid.



## Environmental protection

Your new appliance is particularly energy-efficient. Here you can find tips on how to save even more energy when using the appliance, and how to dispose of your appliance properly.

### Saving energy

- Only preheat the appliance if this is specified in the recipe or in the tables in the operating instructions.
- Use dark, black lacquered or enamelled baking tins. They absorb heat particularly well.
- Open the appliance door as infrequently as possible during operation.
- It is best to bake several cakes one after the other. The cooking compartment is still warm. This reduces the baking time for the second cake. You can place two cake tins next to each other in the cooking compartment.
- For longer cooking times, you can switch the appliance off 10 minutes before the end of the cooking time and use the residual heat to finish cooking.

### Environmentally-friendly disposal

Dispose of packaging in an environmentally-friendly manner.



This appliance is labelled in accordance with European Directive 2012/19/EU concerning used electrical and electronic appliances (waste electrical and electronic equipment - WEEE). The guideline determines the framework for the return and recycling of used appliances as applicable throughout the EU.

## Getting to know your appliance

In this chapter, we will explain the displays and controls. You will also find out about the various functions of your appliance.

**Note:** Depending on the appliance model, individual details and colours may differ.

### Control panel

In the control panel, set the appliance's different functions. The current settings are shown on the display.



- 1** Display
- 2** Touch buttons
- 3** ShiftControl control





	Start/Stop	Starting or stopping the operation → "Setting and starting the appliance operation" on page 12
---	------------	---

### Controls

Use the controls to set your appliance simply and directly.

#### Touch buttons

There are sensors under the touch buttons. Touch on the corresponding touch button to select a function.

Touch button	Use
 on/off	Switching the appliance on or off → "Switching the appliance on and off" on page 11
 Main menu	Selecting operating modes and settings → "Setting and starting the appliance operation" on page 12
 Time-setting options	Setting the timer, cooking time, or "Ready at" start delay → "Time-setting options" on page 14
 Childproof lock	Activating or deactivating the childproof lock → "Childproof lock" on page 17
 Information	Displaying further information Displaying the current temperature → "Setting and starting the appliance operation" on page 12

#### ShiftControl control



Use the ShiftControl control element to navigate through the lines on the display and select the settings. Settings that you can change have left and right arrows < >.



Button	Use
<	Left Navigates to the left on the display
>	Right Navigates to the right on the display
^	Up Navigates upwards on the display
v	Down Navigates downwards on the display

**Note:** You can also scroll through the settings values quickly by pressing and holding a button. As soon as you release the button, you stop scrolling through the values quickly.

#### Main menu





Touch the  touch button to access the main menu.

Menu	Use
	Steaming Setting and starting the appropriate type of steam heating. → "Operating the appliance" on page 11
	Steam programmes Prepare dishes with steam. → "Programmes" on page 15

	Basic settings Individually adjusting the appliance settings → "Basic settings" on page 18
	Descale → "Cleaning" on page 19

## Steaming menu

Your appliance has different types of heating. After switching on the appliance, you are taken directly to the Steaming menu, in which you can find the types of heating.

Type of heating	Temperature	Use
 Steaming	30-100 °C	For vegetables, fish, side dishes, for juicing fruit and for blanching
 Reheating	80-100 °C	For plated meals Cooked food is gently reheated. The steam ensures that the food does not dry out
 Dough proving	30-50 °C	For yeast dough Dough will rise considerably more quickly than at room temperature. The surface of the dough does not dry out
 Defrost setting	30-60 °C	For fruit and vegetables The moisture gently transfers the heat to the food. The food does not dry out or lose its shape

## Cooking compartment functions

The functions in the cooking compartment make your appliance easier to use. This, for example, enables the cooking compartment to be well lit and a cooling fan to prevent the appliance from overheating.

### Opening the appliance door

If you open the appliance door during an operation, the operation is paused. The operation continues to run when you close the door.

**Note:** For some types of heating, the operation continues to run even when the appliance door is open.

### Interior lighting

If you open the appliance door, the interior lighting switches on. If the door remains open for longer than around 15 minutes, the lighting switches off again.

For most operating modes, the interior lighting switches on as soon as the operation is started. When the operation has finished, the lighting switches off.

**Note:** You can set the interior lighting not to come on during the operation in the basic settings. → "Basic settings" on page 18

### Cooling fan

The cooling fan switches on and off as required. The hot air escapes above the door.

### Caution!

Do not cover the ventilation slots. Otherwise, the appliance may overheat.

So that the cooking compartment cools down more quickly after the operation, the cooling fan continues to run for a certain period afterwards.



**Note:** You can change how long the cooling fan continues to run for in the basic settings. → "Basic settings" on page 18

## Accessories

Your appliance is accompanied by a range of accessories. Here, you can find an overview of the accessories included and information on how to use them correctly.

### Accessories included

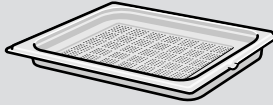
Your appliance is equipped with the following accessories:

	<b>Steam container, perforated, size L</b> For the steaming of whole fish or large quantities of vegetables, for juicing berries, etc.
	<b>Steam container, unperforated, size L</b> For catching dripping liquid when steaming and for cooking rice, pulses and cereals

Only use genuine accessories. They are specially adapted for your appliance.

You can buy accessories from the after-sales service, from specialist retailers or online.



## Inserting accessories

The cooking compartment has four shelf positions. The shelf positions are counted from the bottom up.

In some appliances, the top shelf position in the cooking compartment features a grill symbol.

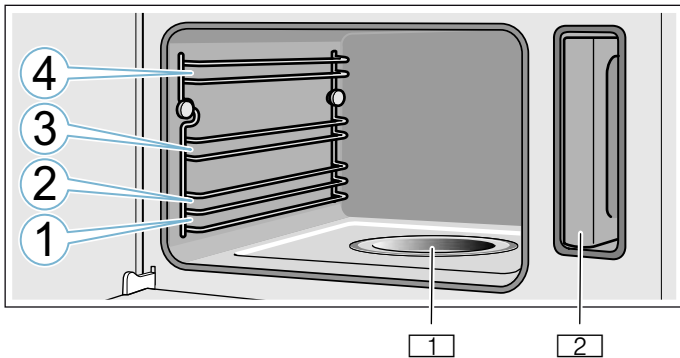

- 1 Evaporator dish
- 2 Water tank in the water tank recess

### Caution!

- Do not place anything on the cooking compartment floor. Do not cover it with aluminium foil. A build-up of heat could damage the appliance. The cooking compartment floor and the evaporator dish must always be kept clear. Always place ovenware in a perforated cooking container or on a wire rack.
- Do not slide any accessories between the shelf positions, or they may tip.

### Locking function

The accessories can be pulled out approximately halfway until they lock in place. The locking function prevents the accessories from tilting when they are pulled out. The accessories must be inserted into the cooking compartment correctly for the tilt protection to work properly.

When inserting the wire rack, ensure that the lug **b** is facing downwards and the **a** safety lug on the wire rack is at the rear and is facing upwards.

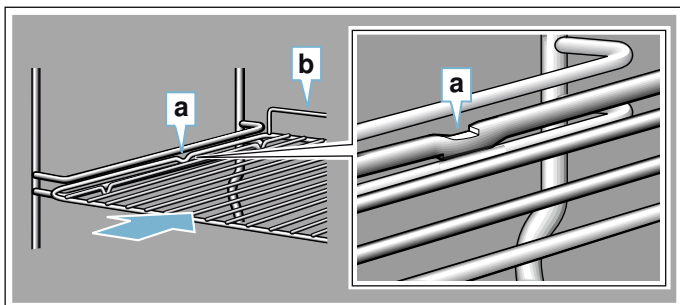

When inserting steam containers, ensure that the lug **c** is facing downwards.

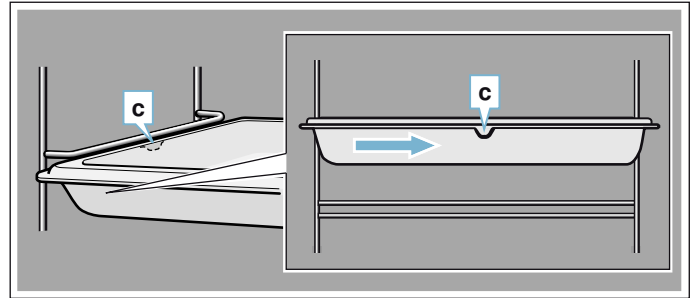

## Optional accessories

You can purchase optional accessories from the after-sales service and specialist retailers, or on the Internet. You will find a comprehensive range of products for your appliance in our brochures and on the Internet.

Both availability and whether it is possible to order online differ between countries. Please see your sales documents for more details.

**Note:** Not all optional accessories are suitable for every appliance. When purchasing, please always quote the exact designation (E no.) of your appliance.  
→ "Customer service" on page 25

### Optional accessories

Steam container, perforated, size S
Steam container, unperforated, size S
Steam container, perforated, size L
Steam container, unperforated, size L
Wire rack for steamer
Porcelain cooking container, unperforated, size S
Porcelain cooking container, unperforated, size L
Decorative strip



## Before using for the first time

Before you can use your new appliance, you must make some settings. You must also clean the cooking compartment and accessories.

### Before using for the first time

Before using the appliance for the first time, enquire about the water hardness of your tap water from your water supplier.

So that the appliance can reliably remind you to decalcify it when required, you must correctly set your water hardness range.

#### Caution!

The appliance may be damaged if unsuitable liquids are used.

Do not use distilled water, highly chlorinated tap water (>40 mg/l) or other liquids.

Only use cold, fresh tap water, softened water or uncarbonated mineral water.

#### Notes

- If your water is very hard, we recommend that you use softened water.
- If you only use softened water, you can set the water hardness range to "softened" in this case.
- If you use mineral water, set the water hardness range to "4 very hard".
- If you use mineral water, only use uncarbonated mineral water.

Water hardness range	Setting
0	0 softened
1 (up to 1.3 mmol/l)	1 soft
2 (1.3 - 2.5 mmol/l)	2 medium
3 (2.5 - 3.8 mmol/l)	3 hard
4 (above 3.8 mmol/l)	4 very hard

### Initial use

As soon as the appliance is connected to the power supply, the first setting "Language" appears on the display.

#### Setting the language

1. Use the  $\vee$  button to navigate to the bottom line.
2. Use the  $\langle$  or  $\rangle$  button to select the language.
3. Use the  $\wedge$  button to return to "Language".
4. Use the  $\rangle$  button to select the next setting.

#### Setting the time

1. Use the  $\vee$  button to navigate to the next line.
2. Use the  $\langle$  or  $\rangle$  button to select the current time.
3. Press the  $\wedge$  button.
4. Use the  $\rangle$  button to select the next setting.

#### Setting the date

1. Use the  $\vee$  button to navigate to the next line.
2. Use the  $\langle$  or  $\rangle$  button to select the current day.
3. Use the  $\wedge$  button to return to "Day".
4. Use the  $\rangle$  button to select the next setting.
5. Use the  $\vee$  button to navigate to the next line.
6. Use the  $\langle$  or  $\rangle$  button to select the current month.
7. Use the  $\wedge$  button to return to "Month".
8. Use the  $\rangle$  button to select the next setting.
9. Use the  $\vee$  button to navigate to the next line.
10. Use the  $\langle$  or  $\rangle$  button to select the current year.
11. Use the  $\wedge$  button to return to "Year".
12. Use the  $\rangle$  button to select the next setting.

#### Setting the water hardness

1. Use the  $\vee$  button to navigate to the bottom line.
2. Use the  $\langle$  or  $\rangle$  button to select the water hardness range.
3. Use the  $\wedge$  button to return to "Water hardness".
4. Use the  $\rangle$  button to apply the settings.  
The initial use is complete.

#### Notes

- You can change these settings at any time in the basic settings. → "Basic settings" on page 18
- After connecting the appliance to the power or following a power cut, the settings for initial use are shown in the display.

### Calibrating the appliance and cleaning the cooking compartment

The boiling point of water depends on the air pressure. During calibration, the appliance sets itself to the pressure ratio at the installation location. This occurs automatically during the first steam operation. This results in a lot of steam.

#### Preparing the calibration

1. Remove the accessories from the cooking compartment.
2. Remove leftover packaging, such as polystyrene pellets, from the cooking compartment.
3. Before calibrating the appliance, wipe the smooth surfaces in the cooking compartment with a soft, wet cloth.

#### Calibrating the appliance and cleaning the cooking compartment

##### Notes

- The calibration can only be started once the cooking compartment is cold (room temperature).
  - Do not open the appliance door during calibration. Calibration will otherwise be interrupted.
1. Use the  $\text{\textcircled{1}}$  touch button to switch on the appliance.
  2. Fill the water tank. → "Filling the water tank" on page 11

- Set the heating type, temperature and cooking time, then start the appliance operation. → "Setting and starting the appliance operation" on page 12

Settings	
Heating type	Steam 
Temperature	100 °C
Cooking time	20 minutes

- Use the  touch button to switch off the appliance.
- Wait until the cooking compartment has cooled down.
- Clean the smooth surfaces with soapy water and a dish cloth.
- Empty the water tank and dry the cooking compartment. → "After each use" on page 13

#### Notes

- So that the appliance adapts to a new installation location after moving house, reset the appliance to the factory settings. Repeat the initial use settings and the calibration.
- The appliance saves the calibration settings, even in the event of a power cut or disconnection from the mains. It must not be calibrated again.

### Cleaning the accessories

Clean the accessories thoroughly using soapy water and a dish cloth or soft brush.

## Operating the appliance

You have already learnt about the controls and how they work. Now we will explain how to set your appliance. You will learn about what happens when you switch the appliance on and off, and how to select the operating mode.

#### Warning – Risk of scalding!

When you open the appliance door, hot steam can escape. Steam may not be visible, depending on its temperature. When opening, do not stand too close to the appliance. Open the appliance door carefully. Keep children away.

#### Warning – Risk of scalding!

The water in the evaporator dish is still hot even after the appliance has been switched off. Do not empty the evaporator dish immediately after switching off the appliance. Allow the appliance to cool down before cleaning it.

### Switching the appliance on and off

Touch the  touch button to switch the appliance on or off.

After switching off the appliance, on the display you can see how high the residual heat in the cooking compartment is.

Display	Meaning
-h-	Residual heat (between 60 °C and 100 °C)

#### Notes

- Certain displays and notes, such as the residual heat in the cooking compartment, remain visible on the display even when the appliance is switched off.
- After an appliance operation, the cooling fan runs on audibly until the cooking compartment has been cooled as far as possible.
- Switch off your device when you do not need to use it. If no settings are applied for a long time, the appliance switches itself off automatically.

### Filling the water tank

When you open the appliance door, you will see the water tank on the right-hand side. Before starting the operation, fill the water tank with water.

Ensure that you have correctly set the water hardness range. → "Basic settings" on page 18

#### Caution!

The appliance may become damaged due to the use of unsuitable liquids.

Do not use distilled water, highly chlorinated tap water (> 40 mg/l) or other liquids.

Only use cold, fresh tap water, softened water or uncarbonated mineral water.

Fill the water tank before each use:

1. Open the appliance door.
2. Remove the water tank from the water tank recess (picture 1).
3. Fill the water tank with cold water up to the "max." mark. (Picture 2).

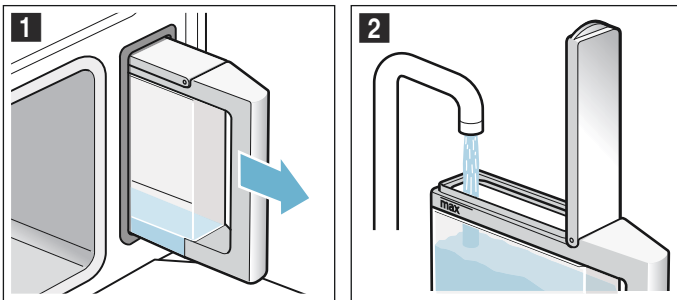

4. Close the tank cover until you feel it engage.
5. Insert the filled water tank (picture 3).
6. Check whether the water tank is pushed in flush with the water tank recess (picture 4).

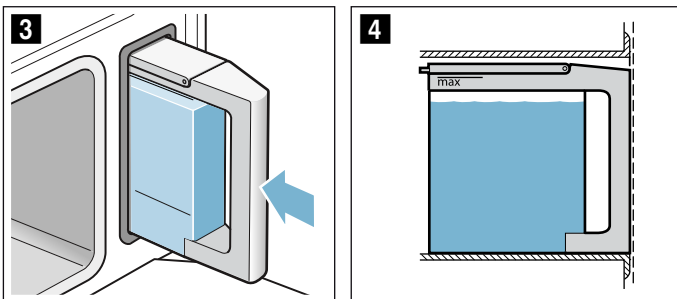

7. Close the appliance door.

The water tank has been filled. You can now start the operation.

### Refilling the water tank

If the water tank is empty, the prompt to fill the water tank appears on the display. The operation is stopped.

1. Carefully open the appliance door.
2. Remove the water tank and fill it.
3. Slide the water tank back in and close the appliance door.
4. Start the operation.  
The operation continues.

### Setting and starting the appliance operation

Example: 15 minutes steaming at 90 °C

1. Touch the touch button to switch on the appliance.  
You are taken directly to the steaming menu.

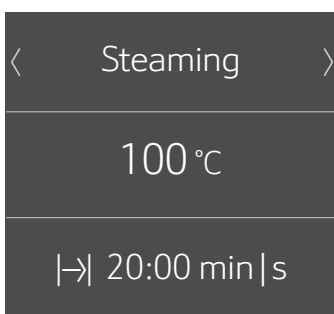

2. Use the or button to select the type of heating.
3. Use the button to navigate to the next line.
4. Use the or button to select the temperature.

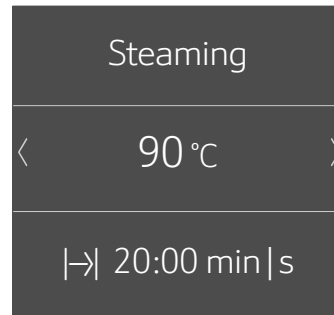

5. Use the button to navigate to the next line.
6. Press the or button to change the cooking time. You are taken to the time-setting options menu.
7. Use the or button to select the cooking time.

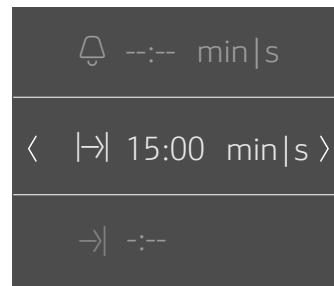

8. Use the button to exit the time-setting options menu.
9. Touch the touch button.  
The appliance starts the operation.

### Notes

- If you have started the steaming type of heating, the cooking time only begins to count down when the set temperature has been reached.
- If you open the appliance door during steaming, the appliance operation stops. After the appliance door has been closed again, the appliance must first heat up to the set temperature before the cooking time continues to count down.
- If you would like to go directly to the main menu after switching on the appliance, you can select the main menu under "Operation after switching on" in the basic settings chapter.

### Default values

The appliance suggests a temperature or setting for each type of heating. You can accept this value or change it in the appropriate area.

### Heating bar

As soon as a type of heating has started, the heating bar appears on the display. The heating bar shows the temperature increase in the cooking compartment.



**Note:** The temperature indicator is not displayed for the steaming type of heating.

### Displaying the current temperature

To show the current temperature on the display, press the  touch button.







The current temperature is shown briefly only when heating up.

### Further information

If the  touch button lights up, information can be displayed. Touch the  touch button to do this. The information is displayed for a few seconds.

## Changing or cancelling the appliance operation

### Changing the appliance operation

1. Use the  button to stop the operation.
2. Use the  or  button to navigate to the line for the setting that should be changed.
3. Use the  or  button to change the setting.
4. Use the  touch button to start the changed operation.

**Note:** The cooling fan may continue to run while an operation is interrupted.

### Cancelling the appliance operation

Press and hold the  touch button until the appliance operation is cancelled.

**Note:** The Descale function cannot be cancelled.

## After each use

### Warning – Risk of scalding!

When you open the appliance door, hot steam can escape. Steam may not be visible, depending on its temperature. When opening, do not stand too close to the appliance. Open the appliance door carefully. Keep children away.

Moisture and dirt remain in the cooking compartment after each operation. Therefore dry and clean the appliance after each use. Also empty the water tank after each use.

### Drying the cooking compartment

### Warning – Risk of scalding!

The water in the evaporator dish may still be hot. Allow it to cool before wiping.

1. Leave the appliance door ajar until the appliance has cooled down.
2. Remove any dirt from the cooking compartment immediately.
3. Wipe out the cooled cooking compartment and evaporator dish with the cleaning sponge and dry with a soft cloth.
4. Wipe the front of the units dry if condensation has formed.

## Emptying the water tank



The water tank must be emptied and dried after each steam operation.

### Caution!

- Do not dry the water tank in the hot cooking compartment. This will damage the water tank.
  - Do not clean the water tank in the dishwasher. This will damage the water tank.
1. Open the appliance door.
  2. Remove the water tank and empty the residual water.
  3. Thoroughly dry the seal in the tank cover and the water tank recess in the appliance.
  4. Insert the water tank into the water tank recess.
  5. Close the appliance door.

## Time-setting options

Your appliance has different time-setting options.

Time-setting option	Use
 Timer	The timer functions like an egg timer. The appliance does not switch on and off automatically.
 Cooking time	Once the set cooking time has elapsed, the appliance switches off automatically.
 Ready at	The appliance switches on automatically, and once the set cooking time has elapsed and the end time has passed, it switches off automatically.

**Note:** If you have set a time-setting option, the time interval increases if you set a higher value. Example: You can set a cooking time of up to one hour in one-minute increments; for cooking times over one hour, you can set a cooking time in five-minute increments.

### Showing and hiding the time-setting options







To show or hide the time-setting options, touch the  touch button.

**Note:** After a particular length of time, the time-setting options that are shown are automatically hidden. If you have already set a cooking time, it will be applied.



### Setting the timer







The timer can be set when the appliance is switched on or off.

1. Touch the  touch button.  
The time-setting options are shown on the display.
2. Select the cooking time using the  button.  
**Note:** When the appliance is switched on, use the  button to navigate to the Timer  line and then select the cooking time using the  button.
3. Touch the  touch button to start the timer.  
The  symbol appears on the display. The timer counts down.

**Note:** As soon as the set time has elapsed, a signal sounds. To cancel the signal tone, touch the  touch button.

### Setting the cooking time

Once the set cooking time has elapsed, the appliance switches off automatically. The function can only be used in combination with a type of heating.

1. Touch the  touch button.
2. Set the type of heating and temperature.
3. Touch the  touch button.  
The time-setting options are shown in the display.
4. Use the  or  button to set the cooking time.
  - Default value for the  button = 10 minutes
  - Default value for the  button = 30 minutes
5. Touch the  touch button to start the set cooking time.







As soon as the cooking time has elapsed, an audible signal sounds and the appliance ends the operation automatically. Touch the  touch button to end the audible signal.

### Start delay – "Ready at"

The appliance switches on automatically and switches off at the preset end time. To do this, set the cooking time and determine the end time for the operation.





The start delay can only be used in combination with a type of heating.

#### Notes

- Ensure that food is not left in the cooking compartment for too long as it may spoil.
  - It is not possible to start every type of heating with a start delay.
1. Slide food into the cooking compartment on a suitable accessory and close the appliance door.
  2. Touch the  touch button.
  3. Set the type of heating and temperature.
  4. Touch the  touch button.  
The time-setting options are shown on the display.
  5. Select the cooking time using the  button.
  6. Use the  button to navigate to the " Ready at" line.
  7. Select the end time using the  button.
  8. Touch the  touch button.  
The appliance waits until the appropriate time to start the operation.

As soon as the end time has passed, a signal sounds and the appliance stops the operation automatically. To cancel the signal tone, touch the  touch button.

### Checking, changing or deleting settings

1. Touch the  touch button.  
The time-setting options are shown on the display.
2. Use the  or  button to navigate through the lines.
3. If necessary, change the setting using the  or  button. Set "00:00" to delete a time function.  
The setting is applied automatically.

## Programmes

You can prepare food very easily using the various programmes. The programme then applies the most suitable settings.









### Selecting a programme

#### **Warning – Risk of scalding!**

Hot steam may escape when the appliance door is opened. Open the appliance door carefully during or after cooking. When opening the door, do not lean over it. Ensure that, depending on the temperature, steam is not visible.

Select the appropriate programme from the programme table. Follow the instructions for the programmes.

**Note:** Do not leave food which spoils easily in the cooking compartment for too long.

1. Touch the  touch button.
2. Use the  or  button to select "Steam programmes ".
3. Use the  button to navigate to the next line. The food options are displayed.
4. Use the  or  button to select the required programme.
5. Use the  button to navigate to the next line.
6. Touch the  touch button. The programme starts.





As soon as the cooking time has elapsed, an audible signal sounds and the appliance ends the operation automatically. Touch the  touch button to end the audible signal.

Some programmes offer you the opportunity to continue cooking your dish.

If you are happy with the cooking result, use the  button to select "Finish".

If you are not happy with the cooking result, you can continue cooking your dish.

### Continue cooking

1. Use the  button to select "Continue cooking". A suggested cooking time appears on the display.
2. If necessary, use the  or  button to adjust the suggested cooking time.
3. Touch the  touch button to start "Continue cooking".  
or  
Wait until the appliance automatically applies your setting.

### Switching off the appliance

Touch the  touch button to switch off the appliance.

### Cancelling

Press and hold the  touch button until the appliance operation is cancelled.

## Information about the programmes

All programmes are designed for cooking on one level.

The cooking result may vary according to the size and quality of the food.

### Cookware

Use the suggested cookware. All meals have been tested using this cookware. The cooking result may change if you use different cookware.

When cooking in the perforated steam container, also insert the solid steam container at level 1. Dripping liquid is caught.

### Amount/weight

Do not fill the food more than 4 cm deep in the accessory.

The total weight must be within the specified weight range.

### Cooking time

The displayed temperature may change during the first few minutes, as the heating-up time depends on the temperature of the food and the water, amongst other things.

### Preparing vegetables

Do not season vegetables until after cooking.

### Preparing cereal products/lentils

Weigh the food and add the correct ratio of water:

Basmati rice 1:1.5

Couscous 1:1

Brown rice 1:1.5

Lentils 1:2

Stir cereal products after cooking. The remaining water is quickly absorbed.

### Steaming chicken breast

Do not place chicken breasts on top of each other in the cookware.

### Steaming fish

When preparing fish, grease the perforated steam container.

Do not place whole fish or fish fillets on top of each other. Enter the weight of the heaviest fish and choose pieces as similar in size as possible.

### Preparing yoghurt

Heat the milk to 90 °C on the hob. Then leave to cool to 40 °C. It is sufficient to heat UHT milk to 40 °C. Stir in 150 g (chilled) yogurt.

Pour into cups or small jars and cover with cling film. Place the cups or jars onto the steamer tray and position as indicated in the table. After preparation, leave the yogurt to cool in the refrigerator.

### Making rice pudding

Weigh the rice and add 2.5 times the amount of milk. Ensure the level of rice and milk in the accessory is no higher than 2.5 cm. Stir after cooking. The remaining milk is quickly absorbed.

### Making fruit compote

The programme is only suitable for fruits with stones and pips. Weigh the fruit and add approximately 1/3 of the water, and add sugar and spices according to taste.

**Sterilising bottles**

Always clean the bottles with a bottle brush immediately after use. Then clean them in the dishwasher.

Place the bottles in the perforated steam container so that they do not touch one another.

Dry the bottles with a clean cloth after sterilising. The process corresponds to normal sterilisation by boiling.

**Cooking eggs**

Pierce the eggs before cooking. Do not place eggs on top of each other.

**Table**

Follow the instructions for the programmes.

Programme	Notes	Accessories	Level
Steam cauliflower florets*	Florets of equal size	perforated + solid steam container	3 1
Steam broccoli florets*	Florets of equal size	perforated + solid steam container	3 1
Steam green beans*	-	perforated + solid steam container	3 1
Steam sliced carrots*	slices, approx. 3 mm thick	perforated + solid steam container	3 1
Steam frozen mixed vegetables	-	perforated + solid steam container	3 1
Unpeeled boiled potatoes*	medium-sized, dia. 4 - 5 cm	perforated + solid steam container	3 1
Basmati rice	max. 0.75 kg	solid steam container	2
Brown rice	max. 0.75 kg	solid steam container	2
Couscous	max. 0.75 kg	solid steam container	2
Lentils	max. 0.55 kg	solid steam container	2
Reheat cooked side dishes*		solid steam container	2
Steam fresh chicken breast	Total weight 0.2 - 1.5 kg	perforated + solid steam container	3 1
Steam fresh fish fillet	max. 2.5 cm thick	perforated + solid steam container	3 1
Steam whole fresh fish	0.3 - 2 kg	perforated + solid steam container	3 1
Yogurt in glass jars	-	jars + solid steam container	2
Rice pudding	-	solid steam container	2
Fruit compote*	-	solid steam container	2
Sterilising bottles*		solid steam container	2
Soft-boiled eggs*	Eggs, size M, max. 1 kg	perforated + solid steam container	3 1
Hard-boiled eggs*	Eggs, size M, max. 1.8 kg	perforated + solid steam container	3 1

\* You can set an operation with a set time for this programme





## Childproof lock

Your appliance is equipped with a childproof lock so that children cannot switch it on accidentally or change any settings.

Your appliance has two different locks.













Lock	Activate/deactivate
Automatic childproof lock	Via the Settings menu → "Basic settings" on page 18
One-time childproof lock	Via the  touch button

**Note:** As soon as you activate the childproof lock, the control panel is locked. The  and  touch buttons are not included. You can deactivate the childproof lock at any time.



### Automatic childproof lock

The control panel is locked so that the appliance cannot be switched on. To switch it on, the automatic childproof lock must be interrupted. After the appliance operation, the control panel is locked automatically.















#### Activating

1. Touch the  touch button.
2. Touch the  touch button.
3. Use the  or  button to select the "Settings".
4. Use the  button to navigate to the next line.
5. Use the  or  button to select "Automatic childproof lock".
6. Use the  button to navigate to the next line.
7. Use the  or  button to select "Activated".
8. Touch the  touch button.
9. Use the  button to navigate to the next line to save the setting.  
The "Automatic childproof lock" is activated. The  symbol appears on the display after switching off the appliance.

#### Cancelling

1. Press and hold the  touch button until "Childproof lock deactivated" appears on the display.
2. Touch the  touch button.
3. Switch on the required appliance operation.



#### Deactivating

1. Press and hold the  touch button until "Childproof lock deactivated" appears on the display.
2. Touch the  touch button.
3. Touch the  touch button.
4. Use the  or  button to select the "Settings".
5. Use the  button to navigate to the next line.
6. Use the  or  button to select "Automatic childproof lock".
7. Use the  button to navigate to the next line.
8. Use the  or  button to select "Deactivated".
9. Touch the  touch button.
10. Use the  button to navigate to the next line to save the setting.  
The "Automatic childproof lock" is deactivated.
11. Touch the  touch button.

### One-time childproof lock

The control panel is locked so that the appliance cannot be switched on. To switch it on, the one-time childproof lock must be deactivated. After the appliance is switched off, the control panel is no longer locked.













#### Activating and deactivating

1. Press and hold the  touch button until "Childproof lock activated" appears on the display.  
The childproof lock is activated.
2. Press and hold the  touch button until "Childproof lock deactivated" appears on the display.  
The childproof lock is deactivated.

## Basic settings

There are various settings available to you in order to help use your appliance effectively and simply. You can change these settings as required.

### Changing the basic settings

1. Touch the  touch button.
2. Touch the  touch button.
3. Use the  or  button to select the "⚙️ Settings".
4. Use the  button to navigate to the next line.
5. Use the  or  button to select the setting.
6. Use the  button to navigate to the next line.
7. Use the  or  button to select the setting.
8. Touch the  touch button.
9. To save the setting, use the  button to select "Save".  
To discard the setting, use the  button to select "Discard".

### List of basic settings

Setting	Selection
Language	Select language
Time of day	Sets the current time
Date	Sets the current date
Water hardness	0 (softened)
	1 (soft)
	2 (medium)
	3 (hard)
	4 (very hard)
Audible signal duration	Short
	Medium
	Long
Button tone	Switched off (Exception: The button tone for the  touch button remains switched on)
	Switched on
Display brightness	Adjustable across 5 levels
Clock display	Digital
	Off
Lighting	On during operation
	Off during operation
Automatic childproof lock	Deactivated
	Activated
Operation after switching on	Steaming
	Main menu
	Steam programmes
Night-time dimming	Switched off
	Switched on (display dimmed between 10 p.m. and 5.59 a.m.)
Brand name logo	Display
	Do not display

Fan run-on time	Recommended
	Minimum
Factory settings	Load

## Cleaning

With good care and cleaning, your appliance will retain its appearance and remain fully functioning for a long time to come. We will explain here how you should correctly care for and clean your appliance.

### **Warning – Risk of short circuit!**

Do not use high-pressure cleaners or steam jet cleaners to clean your appliance.

### **Caution!**

#### **Risk of surface damage**

Do not use

- harsh or abrasive cleaning agents
- oven cleaners
- corrosive or aggressive cleaners, or those containing chlorine
- cleaning agents with a high alcohol content

## cleaning agents

Appliance exterior (with aluminium front)	Use soapy water and dry with a soft cloth. Mild window cleaning agent - wipe over the aluminium front horizontally and without applying pressure using a soft window cloth or a lint-free microfibre cloth.
Appliance exterior (with stainless steel front)	Use soapy water and dry with a soft cloth. Always remove flecks of limescale, grease, starch and albumin (e.g. egg white) immediately. Special stainless steel cleaning agents can be obtained from the after-sales service or from specialist retailers.
Cooking compartment interior with evaporator dish	Hot, soapy water or a vinegar solution - use the enclosed cleaning sponge or a soft washing-up brush. <b>Caution!</b> <b>The cooking compartment could rust.</b> Do not use steel pads or scourers.
Water tank	Soapy water - do not clean in the dishwasher.
Tank recess	Rub dry after every use
Seal in the water tank lid	Thoroughly dry after every use
Rails	See section: Cleaning the rails
Door panels	See section: Cleaning the door panels <b>Caution!</b> <b>Risk of surface damage</b> After cleaning, wipe the door panels with glass cleaner, then dry. Otherwise, stains will be caused that will not be able to be removed.
Door seal	Hot soapy water
Accessories	Soak in hot soapy water. Clean with a brush or washing-up sponge or in the dishwasher. If the rails are discoloured by starchy foods (e.g. rice), clean them with a vinegar solution.

## Cleaning sponge

The enclosed cleaning sponge is very absorbent. Use the cleaning sponge only for cleaning the cooking compartment and for removing residual water from the evaporator dish.

Wash the cleaning sponge thoroughly before using for the first time. You can wash the cleaning sponge in the washing machine (hot wash).

If such an agent comes into contact with the front of the appliance, wash it off immediately with water.

### **Caution!**

#### **Risk of surface damage**

If descaler comes into contact with the front of the appliance or any other sensitive surfaces, wash it off immediately with water.

Remove food residues from the cooking compartment as soon as the appliance has cooled.

Salts are very corrosive and can cause rust. Remove remains of acidic sauces (ketchup, mustard) or salted food from the cooking compartment immediately after cooling.

Do not use hard scouring pads or cleaning sponges.

## Microfibre cloth

The honeycomb microfibre cloth is particularly suitable for cleaning sensitive surfaces such as glass, glass ceramic, stainless steel or aluminium (product no. 460 770, also available from our online eShop). It removes liquid and greasy deposits in one go.

## Descaling

The appliance must be descaled regularly in order for it to continue operating correctly.

There are several steps in the descaling programme. For hygiene reasons, the descaling programme must be run through completely so that the appliance can be ready for operation again.









- Descale (approx. 30 minutes), then empty the evaporator dish and refill the water tank
- First rinsing cycle (20 seconds), then empty the evaporator dish
- Second rinsing cycle (20 seconds), then remove the remaining water

If descaling is interrupted (for example, due to a power failure or because the appliance is switched off), you are prompted to continue with the descaling programme after the appliance is switched back on.

The frequency with which the appliance must be descaled depends on the hardness of the water used. When only five more steam-assisted operations are possible, or fewer, the appliance reminds you to descale it with a message on the display. The number of remaining operations is displayed after the appliance is switched on. You can therefore prepare for the descaling in good time.

### Start

#### Caution!

- Damage to the appliance: Use only liquid descalers that are recommended by us for the descaling programme. The time the product needs to work during descaling depends on the type of descaler used. Other descalers may damage the appliance. Descaler order no. 311 680
  - Descaling solution: Do not allow any descaling solution or descaler to come into contact with the control panel or other delicate surfaces. This will damage the surfaces. If this does happen, remove the descaling solution immediately with water.
1. Mix 300 ml water with 60 ml liquid descaler to make a descaling solution.
  2. Remove the water tank and fill with descaling solution.
  3. Fully insert the water tank filled with the descaling solution.
  4. Close the appliance door.
  5. Touch the  touch button.
  6. Touch the  touch button.
  7. Use the  or  button to select "Descal" .
  8. Use the  button to navigate to the next line. The duration of the descaling programme is displayed. It cannot be changed.
  9. Use the  button to navigate to the next line.
  10. Touch the  touch button. The appliance is descaled. The time counts down on the display. As soon as the descaling programme has finished, an audible signal sounds.

### First rinsing cycle

1. Remove the descaling solution from the evaporator dish using the cleaning sponge.
2. Remove the water tank, rinse thoroughly, fill with water and reinsert.
3. Close the appliance door.
4. Touch the  touch button. The appliance rinses. The first rinsing cycle ends after around 20 seconds.
5. Open the appliance door.
6. Thoroughly rinse out the cleaning sponge with water.
7. Remove the remaining water in the evaporator dish using the cleaning sponge.
8. Proceed with the second rinsing cycle.

### Second rinsing cycle

1. Remove the water tank, rinse thoroughly, fill with water and reinsert.
2. Close the appliance door.
3. Touch the  touch button. The appliance rinses. The second rinsing cycle ends after around 20 seconds.
4. Remove the remaining water in the evaporator dish using the cleaning sponge.
5. Wipe out the cooking compartment using the cleaning sponge and then dry with a soft cloth.
6. Switch off the appliance. Descaling is complete and the appliance is ready for use again.

### Descaling the evaporator dish only

You can also use "Descal" if you do not wish to descale the whole appliance, but only the evaporator dish in the cooking compartment.

The only difference is as follows:

1. Mix 100 ml water with 20 ml liquid descaler to make a descaling solution.
2. Completely fill the evaporator dish with descaling solution.
3. Fill the water tank with water only.
4. Start "Descal" as described.

You can also descale the evaporator dish manually.

## Removing and fitting the appliance door

For cleaning purposes and to remove the door panels, you can detach the appliance door.

The appliance door hinges each have a locking lever. When the locking levers are closed (figure 1), the appliance door is secured in place. It cannot be detached.

When the locking levers are open in order to detach the appliance door (figure 2), the hinges are locked. They cannot snap shut.

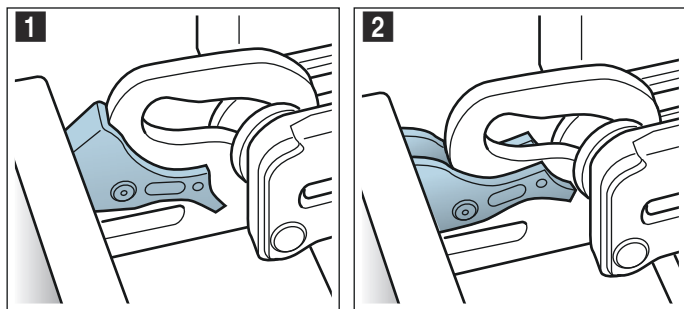

### **Warning** Risk of injury!

- If the hinges are not locked, they can snap shut with great force. Ensure that the locking levers are always fully closed or, when detaching the appliance door, fully open.
- The hinges on the appliance door move when opening and closing the door, and you may be trapped. Keep your hands away from the hinges.

### Removing the appliance door

1. Open the appliance door fully and push it in the direction of the appliance.
2. Fold up the two locking levers on the left and right (figure 1).
3. Close the appliance door as far as it goes **a**. With both hands, grip the door on the left- and right-hand side and pull it up and out (figure 2).

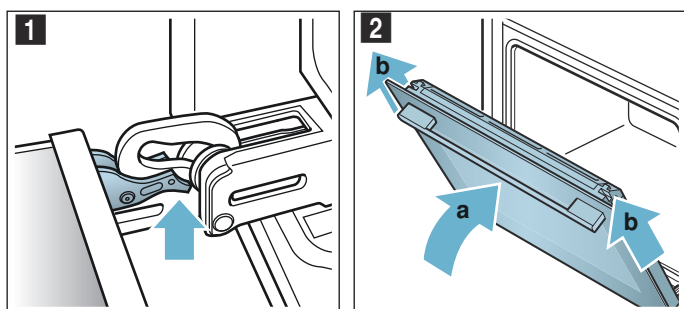

### Fitting the appliance door

Reattach the appliance door in the opposite sequence to removal.

1. When attaching the appliance door, ensure that both hinges are inserted straight into the opening (figure 1).  
Place both hinges at the bottom on the outer panel and use this as a guide.  
Ensure that the hinges are inserted into the correct opening. You must be able to insert them easily and without resistance. If you can feel any resistance, check that the hinges are inserted into the correct opening.

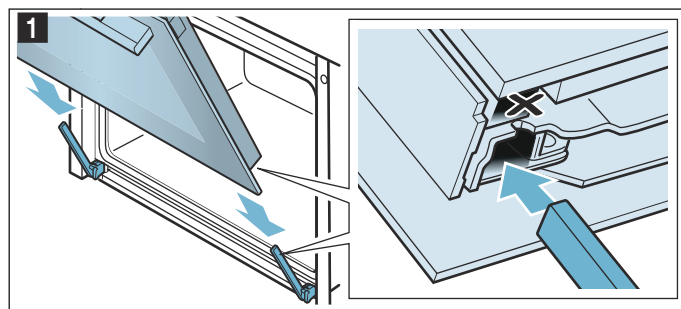

2. Open the appliance door fully. Fold both locking levers closed again (figure 2).

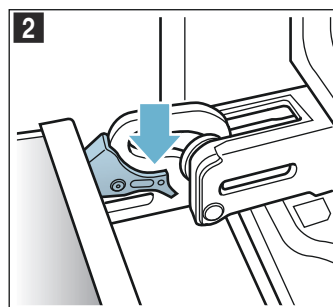

3. Close the cooking compartment door.

### Removing and installing the door panels

To facilitate cleaning, you can remove the glass panels from the appliance door.

#### Removing the door from the appliance

1. Open the appliance door slightly.
2. Press on the right and left side of the cover (figure 1).
3. Remove the cover (figure 2).

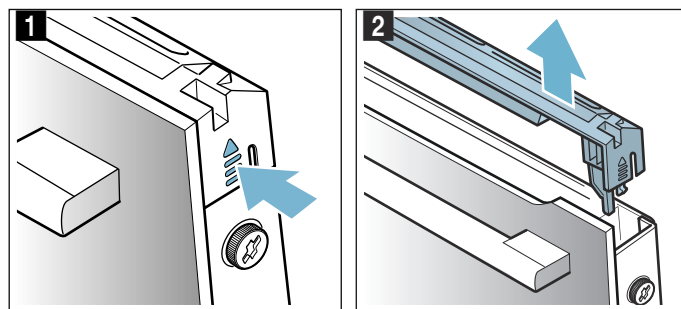

4. Loosen and remove the screws on the left and right of the appliance door (figure 3).
5. Before closing the door again, trap a tea towel which has been folded several times in the door (figure 4). Pull out the front panel upwards and lay it on a flat surface with the door handle facing downwards.

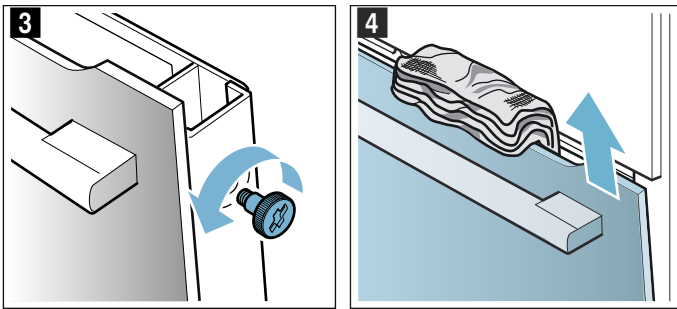

Clean the panels with glass cleaner and a soft cloth.

**⚠ Warning**  
**Risk of injury!**

- Scratched glass in the appliance door may develop into a crack. Do not use a glass scraper, sharp or abrasive cleaning aids or detergents.
- The hinges on the appliance door move when opening and closing the door, and you may be trapped. Keep your hands away from the hinges.

**Fitting the door on the appliance**

1. Insert the front panel at the bottom into the retainers (figure 1).
2. Close the front panel until both upper hooks are opposite the opening (figure 2).

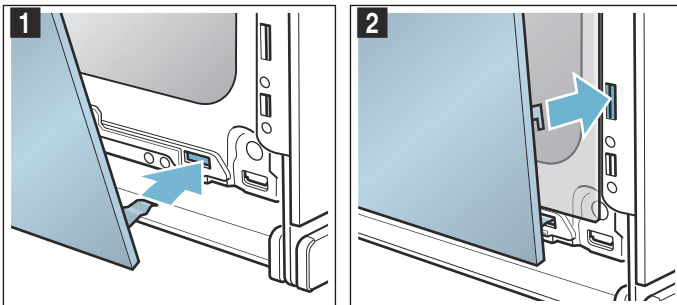

3. Press the front panel at the bottom until it clicks audibly into place (figure 3).
4. Open the appliance door again slightly and remove the tea towel.
5. Screw both screws back in on the left and right.
6. Put the cover back in place and press on it until it clicks audibly into place (figure 4).

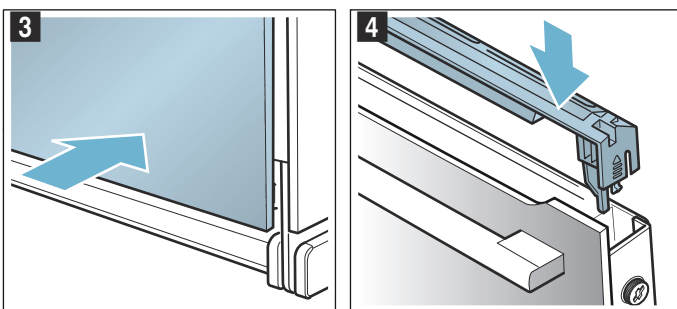

7. Close the appliance door.

**Caution!**

Do not use the cooking compartment again until the panels have been correctly fitted.

**Cleaning the rails**

The rails can be removed for cleaning.

**⚠ Warning – Risk of burning due to hot components in the cooking compartment!**

Wait until the cooking compartment has cooled down.

**Detaching the rails**

**Note:** Swing the front of the rail as far as possible (until you feel resistance), otherwise the appliance side panel may become bent.

1. Carefully press the front of the rail upwards until it becomes detached, and release it from the holder at the side (fig. 1).
2. Detach the rail from the holder and remove it (fig. 2).

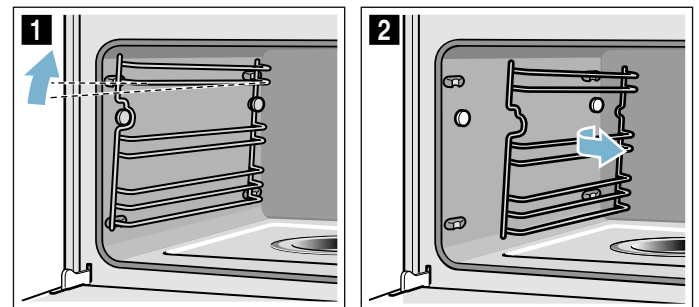

3. Clean the rails with washing-up liquid and a sponge/brush or  
Clean the rails in the dishwasher.

**Attaching the rails**

1. Position the rail so that the indentations are facing upwards.
2. Hook the rail in at the back and push it towards the rear until it engages (fig. 3).
3. Hook the front of the rail onto the holder and press down until it engages and is fixed level in place in the appliance once more (fig. 4).

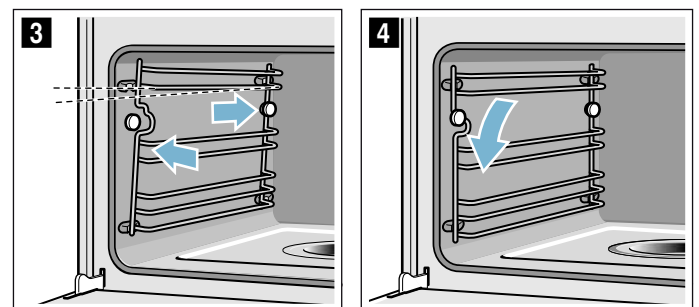

Each set of rails only fits on one side.

## Trouble shooting

If a fault occurs, there is often a simple explanation. Before calling the after-sales service, please refer to the fault table and attempt to correct the fault yourself.

**Tip:** If a meal does not turn out exactly as you wanted, refer to the "Tested for you in our cooking studio" section. Here, you will find plenty of cooking tips and notes.

**⚠ Warning – Risk of electric shock!**  
Incorrect repairs are dangerous. Repairs may only be carried out and damaged power cables replaced by

one of our trained after-sales technicians. If the appliance is defective, unplug the appliance from the mains or switch off the circuit breaker in the fuse box. Contact the after-sales service.

### Fault table

**⚠ Warning – Risk of electric shock!**

- Work on the appliance electronics may only be performed by a specialist.
- Always disconnect the appliance from the power supply when work is carried out on the electronics. Switch off the circuit breaker or remove the fuse from your household fuse box.

Fault	Possible cause	Notes/remedy
The appliance does not work	The plug is not plugged into the mains	Connect the appliance to the power supply
	Power cut	Check whether other kitchen appliances are working
	The circuit breaker is faulty	Check in the fuse box to make sure that the fuse for the appliance is OK
The appliance cannot be switched on; the  symbol is shown on the display	The automatic childproof lock is activated	Press and hold the  touch button until the  symbol goes out
The appliance cannot be operated when it is switched on; the  symbol is shown on the display	The childproof lock is activated	Press and hold the  touch button until the  symbol goes out
The appliance does not heat up;  is shown on the display	Demo mode is activated in the basic settings	Disconnect the appliance from the mains for approx. 10 seconds (switch off the circuit breaker in the fuse box) and then deactivate demo mode in the basic settings within 3 minutes → "Basic settings" on page 18
"EXXX" appears on the display, e.g. "E0111"	Technical problem	Switch the appliance off and back on again If the message appears again, call the after-sales service
The appliance cannot be started	The appliance door is not fully closed	Close the appliance door
	The appliance is not switched off	Switch the appliance off and back on again
The appliance is prompting you to wipe down the cooking compartment and fill the water tank	The power supply has been disconnected or the appliance has been switched off during the descaling process	Once the appliance is switched on again, rinse it twice
After switching on an operating mode, a message is shown on the display which indicates that the temperature is too high	The appliance has not cooled down sufficiently	Allow the appliance to cool down and switch the operating mode on again
The appliance prompts you to descale without the counter appearing beforehand	The set water hardness range is too low	Carry out descaling Check the set water hardness range and adjust it, if necessary
Buttons flash	Normal occurrence caused by condensation behind the control panel	As soon as the condensation has evaporated, the buttons no longer flash
Liquid in the evaporator dish has fully evaporated, even though the water tank is full	The water tank has not been inserted properly	Push in the water tank completely until you feel it engage
	The feed line to the water tank is blocked	Descale the appliance Check the set water hardness range and change it, if necessary
The water tank empties for no discernible reason. The evaporator dish overflows	The water tank was not closed properly	Close the lid until you feel it lock into place
	The tank lid seal is dirty	Clean the seal
	The tank lid seal is faulty	Obtain a new water tank from the after-sales service

The appliance's display prompts you to fill up the water tank even though it is full.	The water tank has not been inserted properly The detection system is not working	Push in the water tank completely until you feel it engage Call the after-sales service
The appliance's display prompts you to fill up the water tank even though it is not yet empty, or the water tank is empty but no corresponding message appears on the display	The water tank is dirty. The moving water level indicators are jammed	Shake and clean the water tank. If the jammed parts cannot be freed, obtain a new water tank from the after-sales service
"Appliance heating" appears on the display but the appliance is not reaching the selected temperature	Automatic calibration values not optimal	Restore the appliance's factory settings and repeat the steps required for first-time operation → "Basic settings" on page 18 → "Before using for the first time" on page 10 The next time you use the steam function at 100 °C, calibration will run automatically and more steam will be produced
When you cook with steam, a lot of steam is produced	The appliance is being automatically calibrated	Normal procedure
When cooking with steam, a lot of steam is produced repeatedly	The appliance is unable to calibrate itself automatically if cooking times are too short	Reset the appliance to the factory settings and repeat the calibration process
Steam escapes from the ventilation slots during cooking	Normal procedure	Not possible

### Replacing the cooking compartment bulb

Heat-resistant 230 V/25 W halogen bulbs with seals are available from the after-sales service. Please specify the E number and FD number of your appliance.

#### **⚠ Warning – Risk of electric shock!**

When replacing the cooking compartment bulb, the bulb socket contacts are live. Before replacing the bulb, unplug the appliance from the mains or switch off the circuit breaker in the fuse box.

#### **⚠ Warning – Risk of burns!**

The appliance becomes very hot. Never touch the interior surfaces of the cooking compartment or the heating elements. Always allow the appliance to cool down. Keep children at a safe distance.

1. Unplug the appliance from the mains or switch off the circuit breaker in the fuse box.
2. Turn the cover anti-clockwise to remove it.
3. Remove the bulb.  
Insert the new bulb, making sure that the pins are in the correct position. Push the bulb in firmly.

#### **Caution!**

Only operate the appliance with the glass cover and seals.

4. Slide the new seals and the clamping ring onto the glass cover in the right order.

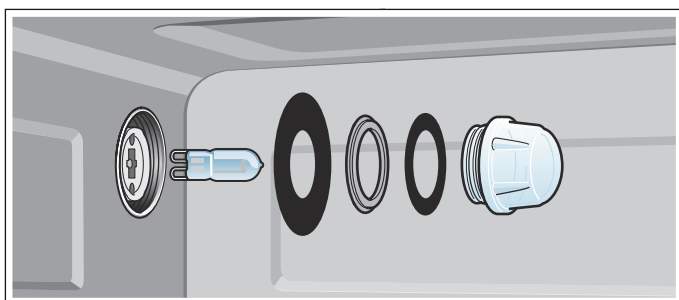

5. Screw the glass cover with the seals back on again.
6. Connect the appliance to the power supply and carry out commissioning again.

### Replacing the glass cover or seals

If the glass cover for the halogen bulb or the seals are damaged, they must be replaced. A new glass cover can be obtained from the after-sales service. Please specify the E number and FD number of your appliance.

### Changing the door seal

If the seal around the outside of the cooking compartment is faulty, it must be replaced. Replacement seals for your appliance can be obtained from the after-sales service. Please specify the E number and FD number of your appliance.

1. Open the appliance door.
2. Pull off the old seal.
3. Push in the new door seal at one point and pull it in all the way round. The joint must be at the side.
4. Check again that the seal is correctly fitted in the corners.

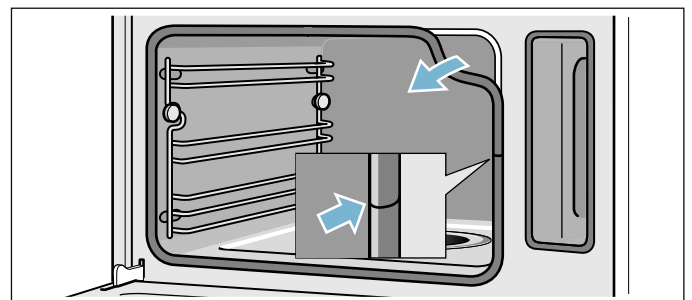



## Customer service

Our after-sales service is there for you if your appliance needs to be repaired. We will always find an appropriate solution, also in order to avoid after-sales personnel having to make unnecessary visits.

### E number and FD number

When calling us, please quote the full product number (E no.) and the production number (FD no.) so that we can provide you with the correct advice. The rating plate bearing these numbers can be found when you open the appliance door.

If your appliance operates with steam, you will find the rating plate on the right-hand side behind the panel.

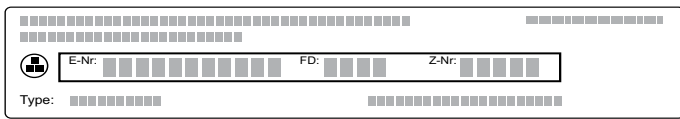

To save time, you can make a note of the numbers for your appliance and the telephone number of the after-sales service in the space below in case you need them.

E no.	FD no.
-------	--------

### After-sales service

Please note that a visit from an after-sales service engineer is not free of charge in the event that the appliance has been misused, even during the warranty period.

Please find the contact data of all countries in the enclosed customer service list.

### To book an engineer visit and product advice

**GB** 0344 892 8989

Calls charged at local or mobile rate.

**IE** 01450 2655

0.03 € per minute at peak. Off peak 0.0088 € per minute.

Rely on the professionalism of the manufacturer. You can therefore be sure that the repair is carried out by trained service technicians who carry original spare parts for your appliances.

## Settings table and tips

Steaming is a particularly gentle way of cooking food. The steam surrounds the dish thereby preventing a loss of nutrients from the food. Cooking takes place without excess pressure. As a result, the shape, colour and typical aroma of the dishes are retained.

The tables contain a selection of dishes which are particularly suitable for your steam oven. You can find out which heating type, accessories, temperature and cooking time are best to select. Unless otherwise stated, the information given applies to inserting accessories when the appliance is cold.

### Accessories

Use the accessories provided.

When steaming in the perforated steam container, always insert the solid steam container underneath. Dripping liquid is caught.

### Ovenware

When using ovenware, always place it in the middle of the perforated steam container.

Ovenware must be heat and steam resistant. Cooking times are increased if thick-sided ovenware is used.

Food which would normally be prepared in a bain-marie should always be covered with foil (e.g. when melting chocolate).

### Cooking time and quantity

The cooking times when steaming depend on the item size, but do not depend on the total quantity. The appliance can steam food to a maximum of 2 kg.

Follow the unit sizes given in the tables. The cooking time is reduced for smaller pieces and increased for larger ones. Cooking time is also influenced by the quality and ripeness of the food. The values quoted can therefore only serve as a guideline.

### Distributing food evenly

Always distribute the food evenly in the ovenware. It will not cook evenly if the layers are of different depths.

### Pressure-sensitive food

When layering delicate foods in the steam container, do not pile them too high. You should ideally use two steam containers.

### Cooking a menu

With steam, you can cook a whole menu at once, without the different flavours mixing. Place the food with the longest cooking time in the appliance first and delay the rest until the appropriate time. This means that all the food will be ready at the same time.

The overall cooking time is extended with menu cooking, as a little steam escapes each time the appliance door is opened and has to be reheated.

## Vegetables

Place the vegetables in the perforated steam container and insert at level 3. Always insert the solid steam container underneath at level 1. Any dripping liquid will be caught.

Food	Size	Accessories	Type of heating	Temperature in °C	Cooking time in min.
Artichokes	whole	perforated + solid	Steaming	100	30 - 35
Cauliflower	whole	perforated + solid	Steaming	100	25 - 35
Cauliflower	florets	perforated + solid	Steaming	100	10 - 15
Broccoli	florets	perforated + solid	Steaming	100	8 - 10
Peas	-	perforated + solid	Steaming	100	5 - 10
Fennel	sliced	perforated + solid	Steaming	100	10 - 14
Vegetable flan	-	1.5 l bain-marie dish + wire rack at level 2	Steaming	100	50 - 70
Green beans	-	perforated + solid	Steaming	100	20 - 25
Carrots	sliced	perforated + solid	Steaming	100	10 - 20
Kohlrabi	sliced	perforated + solid	Steaming	100	20 - 25
Leek	sliced	perforated + solid	Steaming	100	6 - 9
Sweetcorn	whole	perforated + solid	Steaming	100	25 - 35
Swiss chard*	shredded	perforated + solid	Steaming	100	8 - 10
Green asparagus*	whole	perforated + solid	Steaming	100	7 - 12
White asparagus*	whole	perforated + solid	Steaming	100	10 - 15
Spinach*	-	perforated + solid	Steaming	100	2 - 3
Romanesco	florets	perforated + solid	Steaming	100	8 - 10
Brussels sprouts	florets	perforated + solid	Steaming	100	20 - 30
Beetroot	whole	perforated + solid	Steaming	100	40 - 50
Red cabbage	shredded	perforated + solid	Steaming	100	30 - 35
White cabbage	shredded	perforated + solid	Steaming	100	25 - 35
Courgette	sliced	perforated + solid	Steaming	100	3 - 4
Mangetout	-	perforated + solid	Steaming	100	8 - 12

\* Preheat the appliance

## Side dishes and pulses

Add water or liquid in the proportion specified. For example: 1:1.5 = add 150 ml liquid for every 100 g rice.

You may select any shelf position you wish for the solid steam container.

Food	Ratio	Accessories	Level	Type of heating	Temperature in °C	Cooking time in min.
Unpeeled boiled potatoes (medium size)	-	perforated + solid	3 1	Steaming	100	35 - 45
Boiled potatoes (quartered)	-	perforated + solid	3 1	Steaming	100	20 - 25
Brown rice	1:1.5	solid	-	Steaming	100	35 - 45
Long grain rice	1:1.5	solid	-	Steaming	100	20 - 30
Basmati rice	1:1.5	solid	-	Steaming	100	20 - 30
Parboiled rice	1:1.5	solid	-	Steaming	100	15 - 20
Risotto	1:2	solid	-	Steaming	100	30 - 35
Lentils	1:2	solid	-	Steaming	100	35 - 50
Canellini beans, pre-softened	1:2	solid	-	Steaming	100	65 - 75
Couscous	1:1	solid	-	Steaming	100	6 - 10

Food	Ratio	Accessories	Level	Type of heating	Temperature in °C	Cooking time in min.
Unripe spelt grain, coarse ground	1:2.5	solid	-	Steaming	100	15 - 20
Millet, whole	1:2.5	solid	-	Steaming	100	25 - 35
Wheat, whole	1:1	solid	-	Steaming	100	60 - 70
Dumplings	-	perforated + solid	3 1	Steaming	95	20 - 25

## Poultry and meat

### Poultry

Food	Amount	Accessories	Height	Heating type	Temperature in °C	Cooking time in min.
Chicken breast	0.15 kg each	solid	2	Steam	100	15 - 25
Duck breast*	0.35 kg each	solid	2	Steam	100	12 - 18

\* Sear first and wrap in foil

### Beef

Food	Amount	Accessories	Height	Heating type	Temperature in °C	Cooking time in min.
Thin slice of sirloin, medium*	1 kg	solid	2	Steam	100	25 - 35
Thick piece of sirloin, medium*	1 kg	perforated + solid	3 1	Steam	100	30 - 40

\* Sear first and wrap in foil

### Pork

Food	Amount	Accessories	Level	Type of heating	Temperature in °C	Cooking time in min.
Fillet of pork	0.5 kg	solid	2	Steaming	100	16 - 20
Pork medallions*	approx. 3 cm thick	solid	2	Steaming	100	10 - 12
Smoked pork ribs	sliced	solid	2	Steaming	100	15 - 20

\* Sear first and wrap in foil

### Sausages

Food	Accessories	Level	Type of heating	Temperature in °C	Cooking time in min.
Wiener sausages	perforated + solid	3 1	Steaming	80 - 90	12 - 18
Bavarian veal sausages	perforated + solid	3 1	Steaming	80 - 90	20 - 25

### Fish

Food	Amount	Accessories	Height	Heating type	Temperature in °C	Cooking time in min.
Sea bream, whole	0.3 kg each	perforated + solid	3 1	Steam	80 - 90	15 - 25
Sea bream fillet	0.15 kg each	perforated + solid	3 1	Steam	80 - 90	10 - 20
Fish terrine	1.5 l bain-marie dish	solid	2	Steam	70 - 80	40 - 80
Trout, whole	0.2 kg each	perforated + solid	3 1	Steam	80 - 90	12 - 15

Food	Amount	Accessories	Height	Heating type	Temperature in °C	Cooking time in min.
Cod fillet	0.15 kg each	perforated + solid	3 1	Steam	80 - 90	10 - 14
Salmon fillet	0.15 kg each	perforated + solid	3 1	Steam	100	8 - 10
Mussels	1.5 kg	solid	2	Steam	100	10 - 15
Ocean perch fillet	0.15 kg each	perforated + solid	3 1	Steam	80 - 90	10 - 20
Sole rolls, stuffed		perforated + solid	3 1	Steam	80 - 90	10 - 20

### Soup vegetables, miscellaneous

Food	Accessories	Height	Heating type	Temperature in °C	Cooking time in min.
Royale (egg custard)	solid	2	Steam	90	15 - 20
Semolina dumplings	perforated + solid	3 1	Steam	90 - 95	7 - 10
Hard-boiled eggs (Size M, max. 1.8 kg)	perforated + solid	3 1	Steam	100	10 - 12
Soft-boiled eggs (Size M, max. 1 kg)	perforated + solid	3 1	Steam	100	6 - 8

### Dessert, compote

#### Compote

Weigh the fruit and add approximately  $\frac{1}{3}$  of the water, then add sugar and spices according to taste.

#### Rice pudding

Weigh the rice and add 2.5 times the amount of milk. Ensure the level of rice and milk in the accessory is no higher than 2.5 cm. Stir after cooking. The remaining milk is quickly absorbed.

#### Yogurt

Heat the milk to 90 °C on the hob. Then leave to cool to 40 °C. It is sufficient to heat UHT milk to 40 °C.

Stir in 150 g (chilled) yogurt. Pour into cups or small jars and cover with cling film. Place the cups or glasses onto the steamer tray and set as indicated in the table.

After preparation, leave the yogurt to cool in the refrigerator.

Food	Accessories	Type of heating	Temperature in °C	Cooking time in min.
Yeast dumplings	solid	Steaming	100	20 - 25
Crème caramel	small moulds + perforated	Steaming	80	15 - 20
Rice pudding*	solid	Steaming	100	25 - 35
Yoghurt*	Portion-sized glasses + perforated	Steaming	40	300 - 360
Apple compote	solid	Steaming	100	10 - 15
Pear compote	solid	Steaming	100	10 - 15
Cherry compote	solid	Steaming	100	10 - 15
Rhubarb compote	solid	Steaming	100	10 - 15
Plum compote	solid	Steaming	100	15 - 20

\* You can also use the appropriate programme (see section: Automatic programmes)

## Reheating food

Using Reheat, dishes can be gently reheated. They taste and look like they have been freshly prepared.

Food	Accessories	Level	Type of heating	Temperature in °C	Cooking time in min.
Vegetables	solid steam container	3	Reheating	100	12 - 15
Pasta, potatoes, rice	solid steam container	3	Reheating	100	5 - 25

## Defrosting

The steam function "Defrost" is suitable for defrosting frozen fruit and vegetables. It is best to allow poultry, meat and fish to defrost in the refrigerator. To defrost the frozen food, remove it from its packaging. Place frozen fruit and vegetables into the steaming pan with the perforated base, and place the steaming pan with the unperforated base underneath. This keeps the food away from the water that forms as it defrosts, and allows this water to be collected as it drips down. For frozen food that needs to retain liquid when it is cooked, e.g. creamed spinach, use the steaming pan with the

unperforated base or cookware placed on the wire rack.

The times specified in the table are intended as a guide. They are dependent on the quality, freezing temperature (-18 °C) and composition of the food. Time ranges are specified. Set the shortest time initially, and then extend the time if necessary.

**Tip:** Food that has been frozen in thinner pieces or in portions defrosts more quickly than food items frozen in a block.

Food	Amount	Accessories	Level	Temperature in °C	Cooking time in min.
Berries	0.5 kg	perforated + solid	3 1	50 - 55	15 - 20
Vegetables	0.5 kg	perforated + solid	3 1	40 - 50	15 - 50

## Dough proving

Dough will prove considerably more quickly using the dough proving setting than at room temperature.

You may select any shelf position you wish for the wire rack or place the wire rack carefully on the cooking

compartment floor.

Caution: Do not scratch the cooking compartment floor.

Place the dough bowl on the wire rack. Do not cover the dough.

Food	Amount	Accessories	Temperature in °C	Cooking time in min
Yeast dough	1 kg	Bowl + wire rack	35	20 - 30

## Extracting juice

Before juicing, place the berries in a bowl and sprinkle with sugar. Leave to stand for at least one hour to draw out the juice.

Pour the berries into the perforated steam container and insert at level 3. Insert the solid steam container at level 1 to catch the juice.

Finally, place the berries in a cloth and squeeze out the rest of the juice.

Food	Accessories	Height	Heating type	Temperature in °C	Cooking time in min.
Raspberries	perforated + solid	3 1	Steam	100	30 - 45
Redcurrants	perforated + solid	3 1	Steam	100	40 - 50

## Preserving

Preserve food which is as fresh as possible. When foods are stored for a relatively long period, their vitamin content is reduced and they ferment and spoil more easily.

Only use fruit and vegetables which are in perfect condition.

The following foods cannot be preserved with your appliance:

Contents of tins, meat, fish or pastry dough.

Check preserving jars, rubber rings, clips and springs.

Clean rubber rings and jars thoroughly with hot water. The "Sterilise bottles" programme is also suitable for cleaning jars.

Place the jars into the perforated steam container. They must not touch each other.

After the specified cooking time, open the appliance door.

Do not remove the preserving jars from the appliance until they have completely cooled down.

Food	Accessories	Height	Heating type	Temperature in °C	Cooking time in min.
Vegetables	1-litre preserving jars	2	Steam	100	30 - 120
Stone fruits	1-litre preserving jars	2	Steam	100	25 - 30
Pip fruits	1-litre preserving jars	2	Steam	100	25 - 30

## Frozen products

Observe the manufacturer's instructions on the packaging.

The cooking times indicated apply to dishes placed in a cold cooking compartment.

Food	Accessories	Level	Type of heating	Temperature in °C	Cooking time in min.
Pasta, fresh, refrigerated*	solid	2	Steaming	100	5 - 10
Trout	perforated + solid	3 1	Steaming	80 - 100	20 - 25
Salmon fillet	perforated + solid	3 1	Steaming	80 - 100	20 - 25
Broccoli	perforated + solid	3 1	Steaming	100	6 - 10
Cauliflower	perforated + solid	3 1	Steaming	100	5 - 8
Beans	perforated + solid	3 1	Steaming	100	6 - 10
Peas	perforated + solid	3 1	Steaming	100	5 - 12
Carrots	perforated + solid	3 1	Steaming	100	4 - 6
Mixed vegetables	perforated + solid	3 1	Steaming	100	6 - 10
Brussels sprouts	perforated + solid	3 1	Steaming	100	5 - 10

\* Add a little liquid

**Test dishes**

Test dishes in accordance with EN 60350-1.

These tables have been produced for test institutes to facilitate the inspection and testing of the various appliances.

Food	Accessories	Level	Type of heating	Temperature in °C	Cooking time in min.
Broccoli (Steam distribution)	perforated + solid	3 1	Steaming	100	7 - 9
Broccoli (Steam supply)	perforated + solid	3 1	Steaming	100	7 - 9
Peas* (Maximum load)	perforated + solid	3 1	Steaming	100	5 - 12
* Spread out 2.0 kg peas evenly in the container.					



Constructa Neff  
Vertriebs-GmbH  
Carl-Wery-Straße 34  
D-81739 München

Register your product online

[www.neff-international.com](http://www.neff-international.com)



9000943390  
960706  
en