

# TASSIMO

FIDELIA



## TAS 40xx TAS 42xx

de Gebrauchsanleitung  
en Instruction manual  
fr Mode d'emploi  
es Instrucciones de uso  
pt Instruções de serviço  
it Istruzioni per l'uso  
nl Gebruiksaanwijzing  
sv Bruksanvisning  
da Brugsanvisning  
no Bruksanvisning  
el Οδηγίες χρήσης  
pl Instrukcja obsługi  
cs Návod k použití  
sk Návod na použitie  
ro Instrucțiuni de utilizare  
ru Правила пользования  
uk Інструкція з експлуатації  
ko 사용 설명서

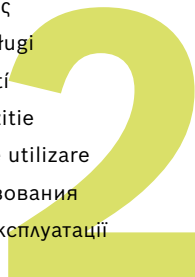

**BOSCH**



**de** Inbetriebnahme  
**en** First time use  
**fr** La première utilisation  
**es** Puesta en servicio  
**pt** Primeira utilização  
**it** Messa in funzione  
**nl** Ingebruikneming  
**sv** Idrifttagning  
**da** Ibrugtagning

**no** Første gangs bruk  
**el** Θέση σε λειτουργία  
**pl** Uruchamianie  
**cs** Uvedení do provozu  
**sk** Uvedenie do prevádzky  
**ro** Prima utilizare  
**ru** Ввод в эксплуатацию  
**uk** Перше використання  
**ko** 처음 사용할 때



**de** Getränkezubereitung  
**en** Beverage preparation  
**fr** Préparation de boissons  
**es** Preparación de bebidas  
**pt** Preparação de bebidas  
**it** Preparazione delle bevande  
**nl** Toebereiden van dranken  
**sv** Tillredning av drycker  
**da** Tilberedelse af drikke

**no** Tilberedning av drikker  
**el** Παρασκευή ροφήματος  
**pl** Przygotowanie napoju  
**cs** Příprava nápojů  
**sk** Príprava nápojov  
**ro** Prepararea băuturilor  
**ru** Приготовление напитков  
**uk** Приготування напою  
**ko** 음료 준비



**de** Reinigen  
**en** Cleaning  
**fr** Nettoyage  
**es** Limpiar  
**pt** Limpar  
**it** Pulizia  
**nl** Reinigen  
**sv** Rengöring  
**da** Rengøring

**no** Rengjøring  
**el** Καθαρισμός  
**pl** Czyszczenie  
**cs** Čistění  
**sk** Čistenie  
**ro** Curățarea  
**ru** Очистка  
**uk** Очищення  
**ko** 청소



**de** Entkalken  
**en** Descaling  
**fr** Détartrage  
**es** Descalcificar  
**pt** Descalcificar  
**it** Decalcificare  
**nl** Ontkalken  
**sv** Avkalkning  
**da** Afkalkning

**no** Avkalking  
**el** Απασβέστωση  
**pl** Odkamianie  
**cs** Odstranění vodního kamene  
**sk** Odstránenie vodného kameňa  
**ro** Decalcifierea  
**ru** Удаление накипи  
**uk** Видалення накипу  
**ko** 석회질 제거

de Stromschlaggefahr!  
 en Risk of electric shock!  
 fr Risque de choc électrique!  
 es ¡Peligro de electrocución!  
 pt Perigo de choque eléctrico!  
 it Pericolo di scossa elettrica!  
 nl Gevaar van elektrische schok!  
 sv Risk för elektrisk stöt!  
 da Fare for elektrisk stød!  
 no Fare for elektrisk støt!  
 el Κίνδυνος ηλεκτροπληξίας!

pl Niebezpieczeństwo porażenia prądem!  
 cs Nebezpečí úrazu elektrickým proudem!  
 sk Nebezpečenstvo zasiahnutia elektrickým prúdom!  
 ro Pericol de electrocutare!  
 ru Опасность поражения током!  
 uk Небезпека ураження електричним струмом!  
 ko 감전 위험!



de Verbrennungsgefahr!  
 en Risk of burns!  
 fr Risque de brûlure!  
 es ¡Peligro de quemaduras!  
 pt Perigo de queimadura!  
 it Pericolo di ustioni!  
 nl Verbrandingsgevaar!  
 sv Brännskaderisk!  
 da Fare for forbrænding!

no Fare for forbrenning!  
 el Κίνδυνος εγκαυμάτων!  
 pl Niebezpieczeństwo poparzenia!  
 cs Nebezpečí opaření!  
 sk Nebezpečenstvo oparenia!  
 ro Pericol de arsuri!  
 ru Риск получения ожогов!  
 uk Небезпека опшарення!  
 ko 화상 위험!

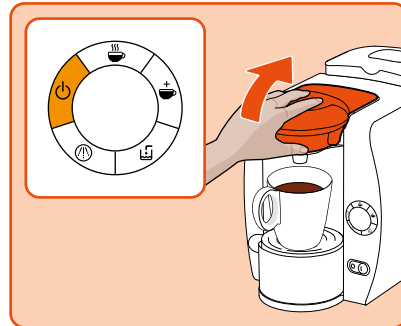
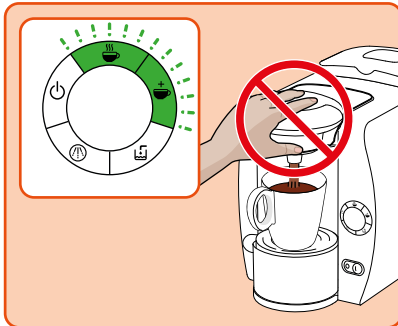

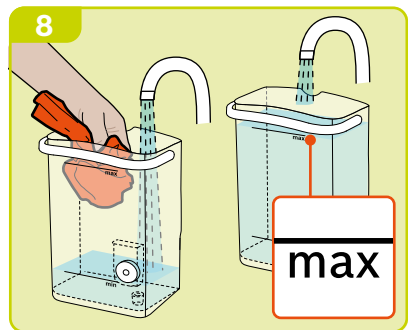
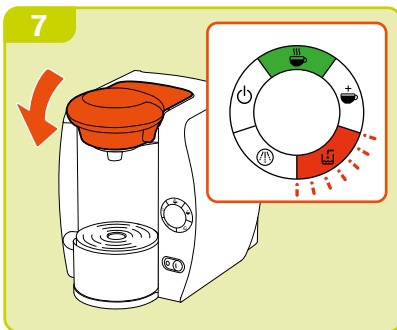
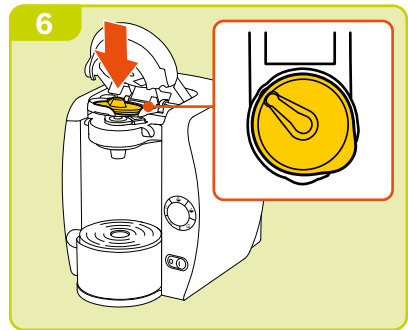
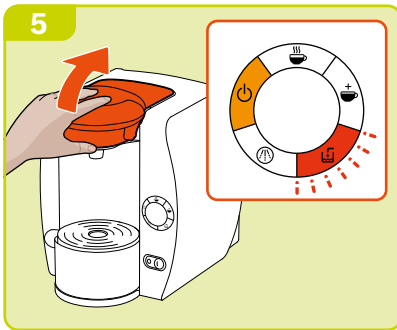
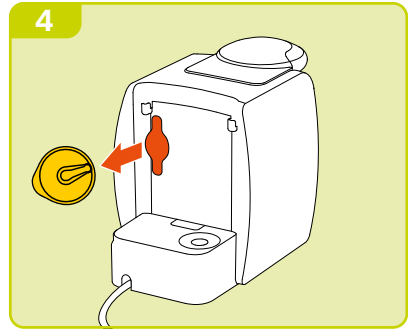
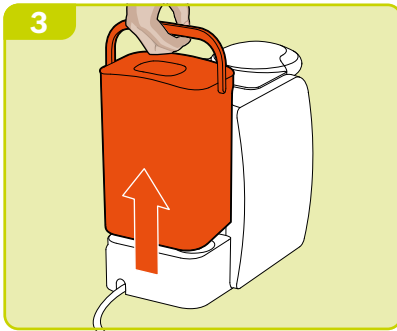
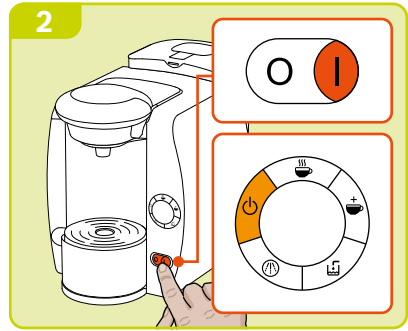
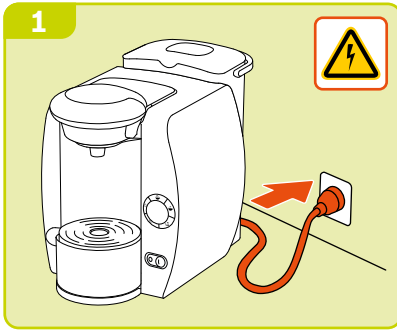

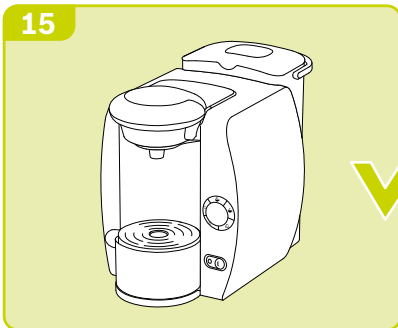
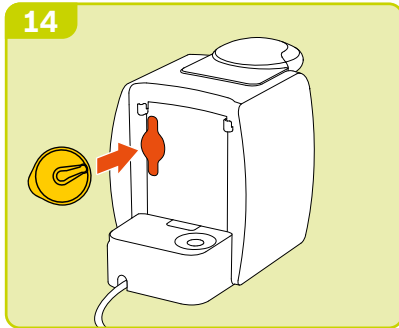
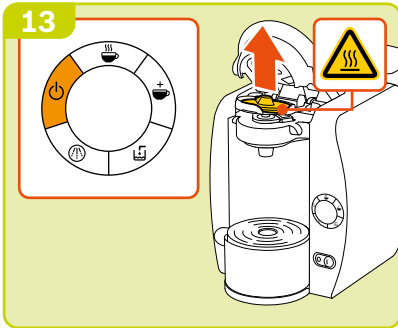
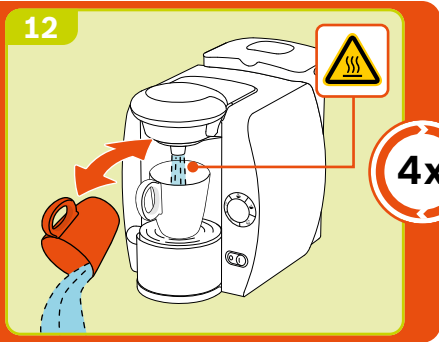
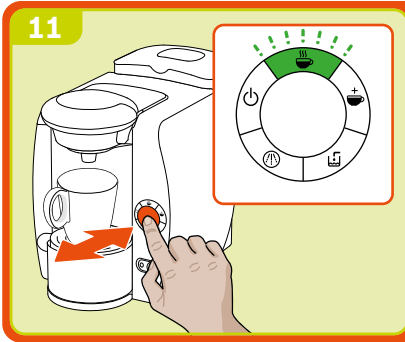
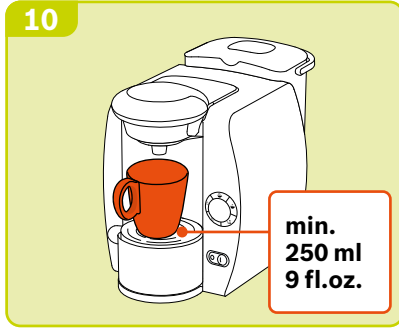
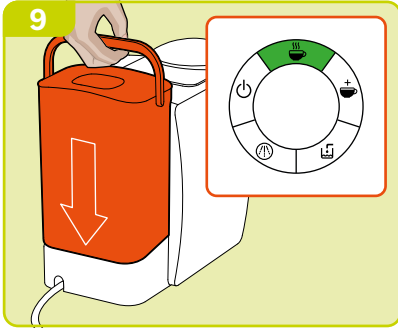

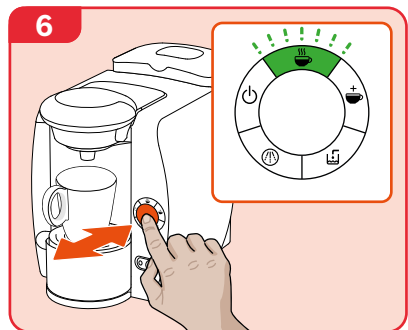
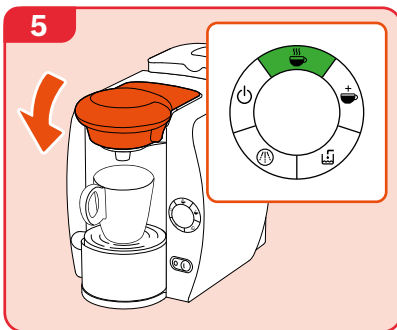
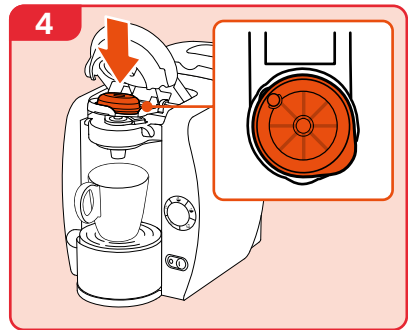
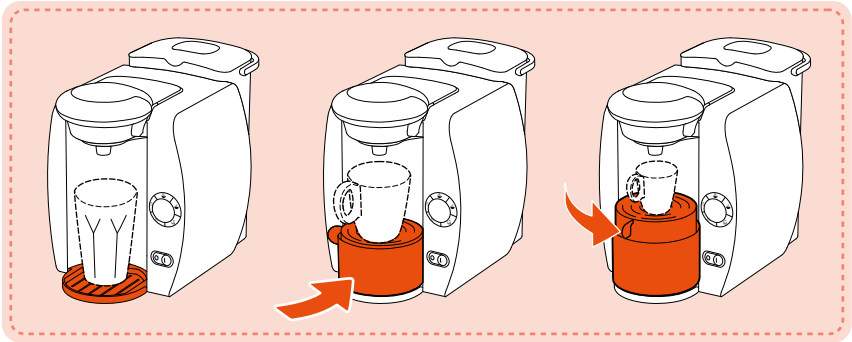
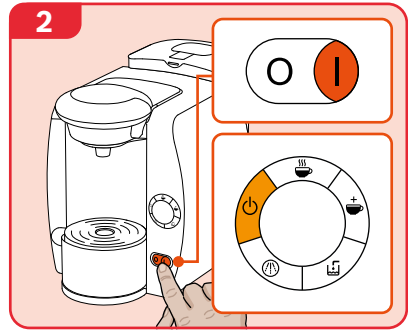
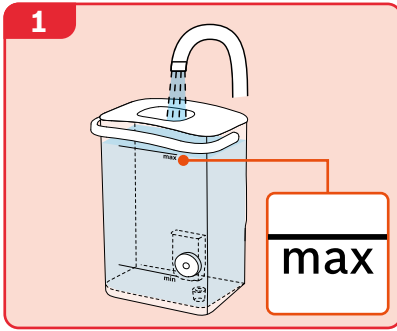

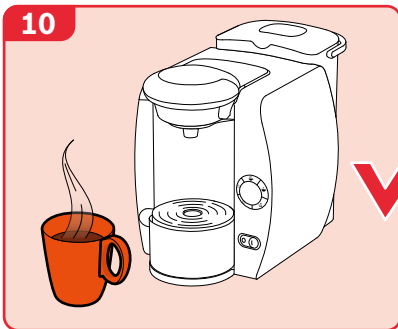
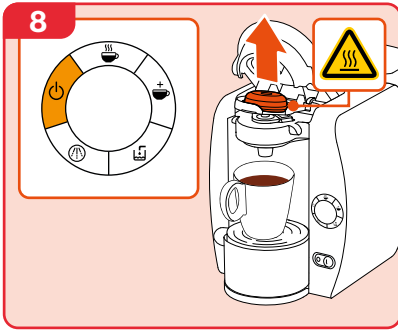
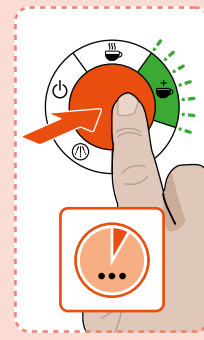
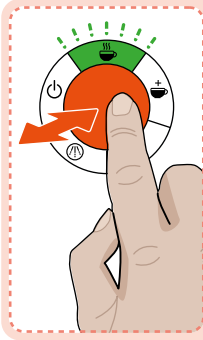
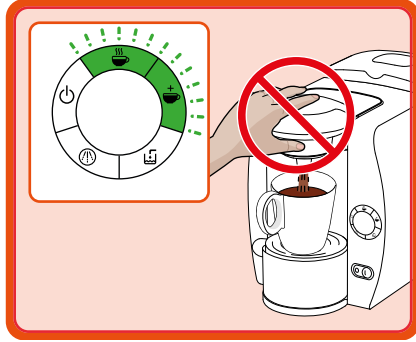
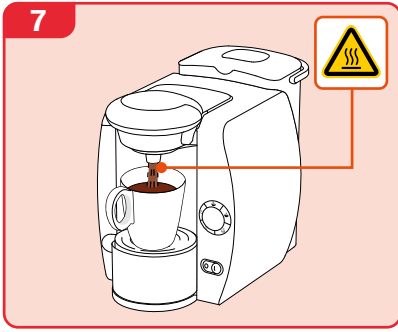

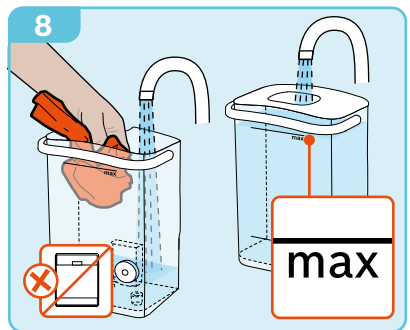
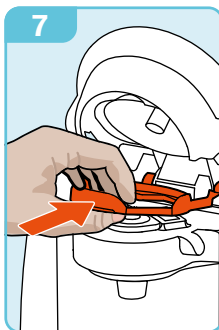
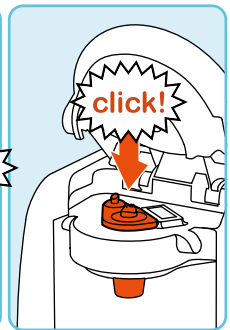
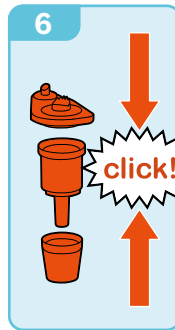
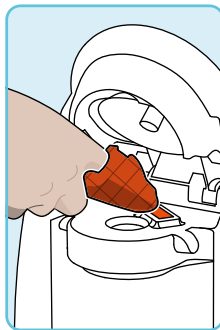
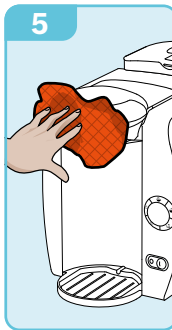
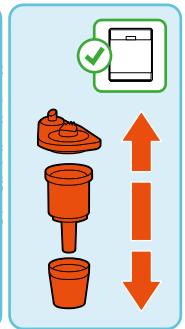
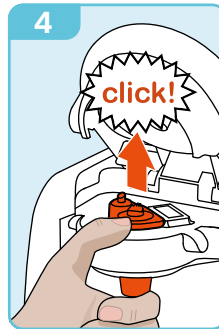
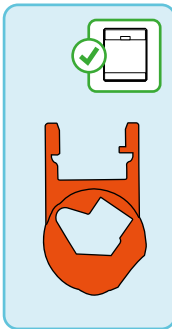
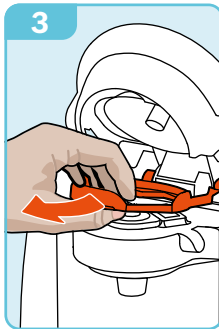
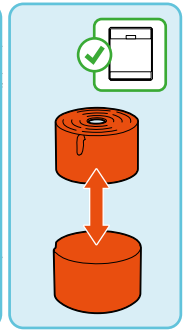
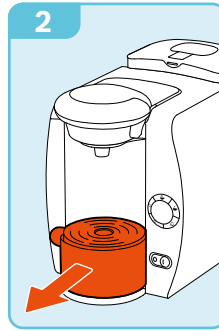
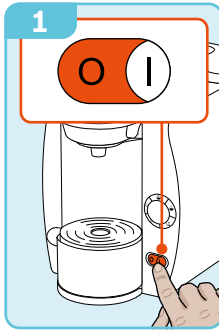



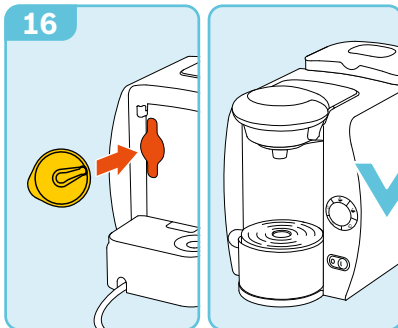
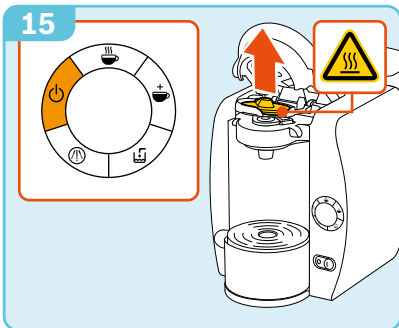
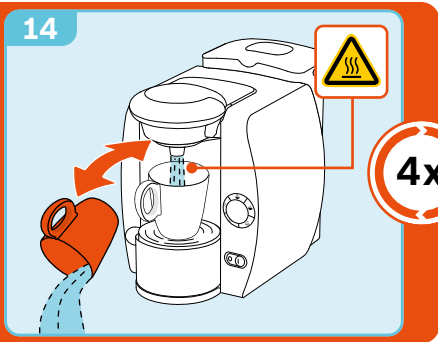
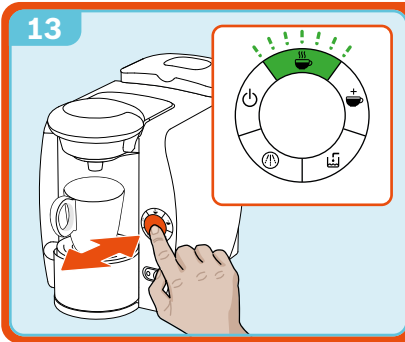
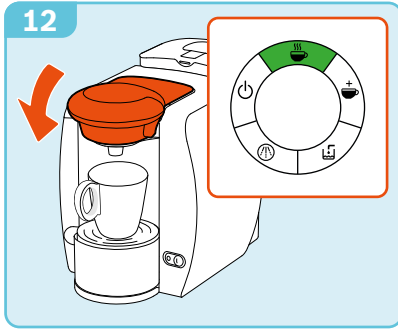
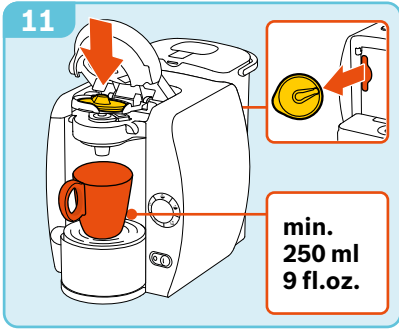
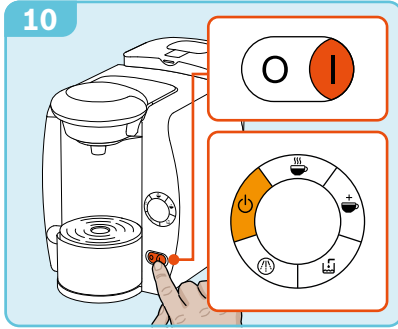
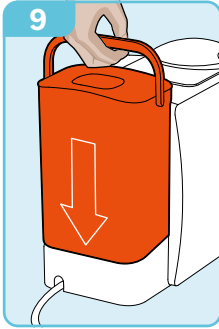

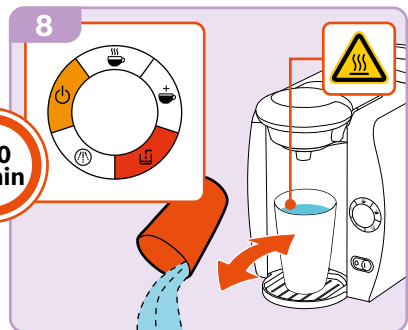
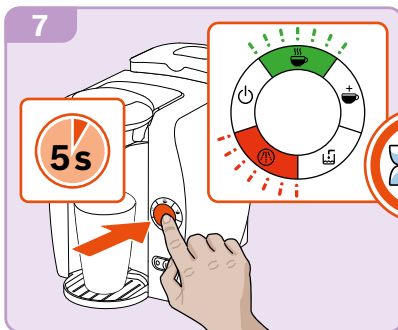
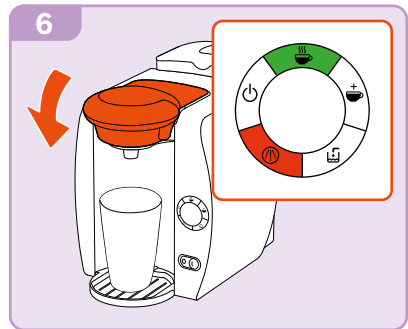
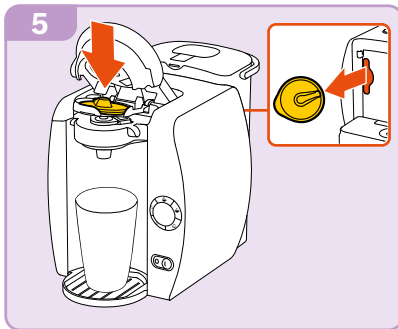
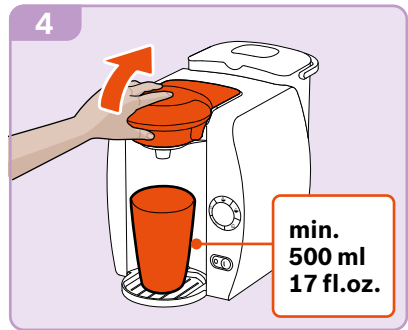
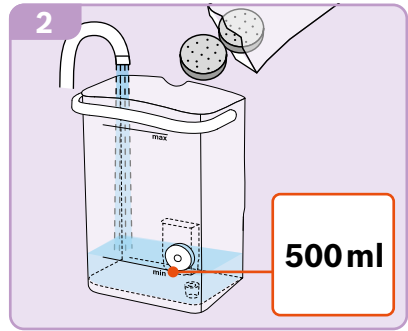
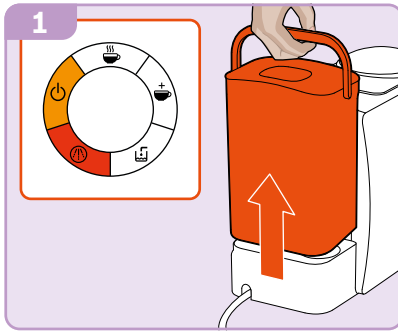

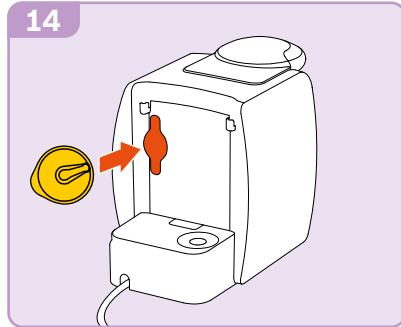
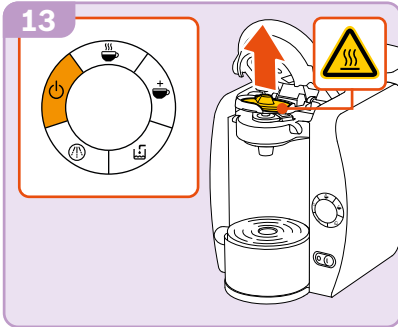
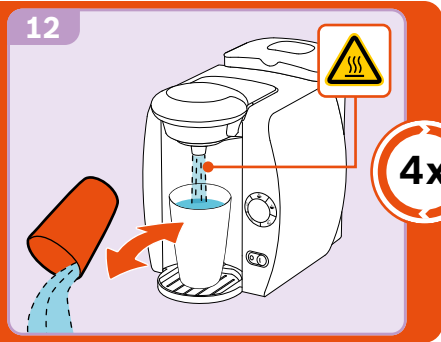
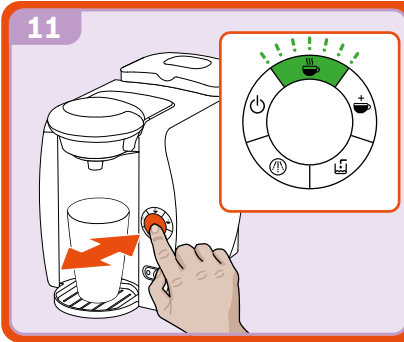
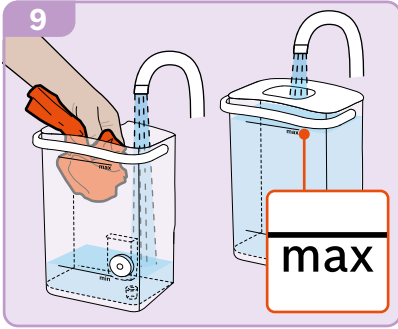



- de** Beachten Sie unbedingt die Sicherheitshinweise in der beiliegenden Gebrauchsanleitung – Teil 1! Dort finden Sie auch detaillierte Informationen zum Gebrauch, Garantiehinweise und Kontaktadressen.
- en** Always follow the safety instructions in the included manual part 1! You will also find detailed information regarding Care and Use, Warranty and Contact information for Customer Service.
- fr** Suivez toujours les consignes de sécurité fournies dans la partie 1 de ce manuel. Vous trouverez également des informations sur l'entretien, l'utilisation, les conditions de garantie et les coordonnées du service client.
- es** Lea atentamente estas instrucciones de uso y la información adjunta antes de utilizar la máquina. También encontrará información detallada referente al uso, garantía y direcciones de contacto.
- pt** Respeite impreterivelmente os avisos de segurança que se encontram na parte 1 das instruções de serviço fornecidas! Encontrará também informações detalhadas a respeito da utilização, garantia e informações de contacto.
- it** Seguire sempre le avvertenze di sicurezza nelle istruzioni per l'uso allegate – Parte 1! È inoltre possibile trovare informazioni dettagliate sull'uso, informazioni sulla garanzia e indirizzi di contatto.
- nl** Neem altijd de veiligheidsaankwijzingen uit deel 1 van de meegeleverde gebruiksaanwijzing in acht! In deze gebruiksaanwijzing vindt u tevens gedetailleerde informatie over het gebruik en de garantie, evenals contactadressen.
- sv** Beakta säkerhetsanvisningarna i del 1 i den bifogade bruksanvisningen. Där hittar du också detaljerade informationer om användningen, garantin och kontaktadresser.
- da** Følg under alle omstændigheder sikkerhedsanvisningerne i den vedlagte brugsanvisning – del 1! Her finder du også detaljer om brug, garantioplysninger og kontaktadresser.
- no** Følg alltid instruksjonene i den vedlagte bruksanvisningen – del 1! Der finner du også detaljert informasjon om bruk, garantivilkår og kontaktadresser.
- el** Προσέξτε οπωσδήποτε τις υποδείξεις ασφαλείας στις συνημμένες οδηγίες χρήσης – μέρος 1! Εκεί θα βρείτε επίσης λεπτομερείς πληροφορίες για τη χρήση, υποδείξεις εγγύησης και διευθύνσεις επικοινωνίας.
- pl** Należy koniecznie przestrzegać instrukcji bezpieczeństwa w dołączonej instrukcji obsługi – część 1! Można znaleźć tam również szczegółowe informacje na temat użytkowania urządzenia, gwarancji oraz adresy kontaktowe.
- cs** Vždy dbejte bezpečnostních pokynů uvedených v přiloženém návodu k použití – část 1! Zde najdete také podrobné informace týkající se použití, záruční podmínky a kontaktní adresy.
- sk** Venujte bezpodmienečne pozornosť bezpečnostným pokynom uvedeným v priloženom návode na použitie – časť 1! Tu nájdete aj podrobné informácie o používaní, záručné podmienky a kontaktné adresy.
- ro** Vă rugăm să respectați obligatoriu instrucțiunile de siguranță prezentate în instrucțiunile de utilizare atașate - partea 1! Acolo găsiți informații detaliate cu privire la utilizare, indicații referitoare la garanție și date de contact.
- ru** Обязательно соблюдайте указания по технике безопасности, которые приведены в части 1 инструкции по эксплуатации! В инструкции Вы найдете подробную информацию об использовании и гарантии, а также контактные данные.
- uk** Обов'язково дотримуйтеся вказівок з техніки безпеки в доданій інструкції з експлуатації – частина 1! Там міститься також детальна інформація щодо використання, вказівки про гарантію та контактні адреси.
- ko** 함께 제공된 사용 설명서의 파트 1에 있는 안전 지침을 반드시 따르십시오. 관리와 사용, 보증 및 고객 서비스 센터의 연락처 정보에 관한 자세한 정보를 찾아볼 수 있습니다.

## Robert Bosch Hausgeräte GmbH

Carl-Wery-Str. 34, 81739 München / Germany

www.bosch-home.com

9000 942 662 – 11/13