

TASSIMO

SUNY



TAS 32xx

de Gebrauchsanleitung
en Instruction manual
fr Mode d'emploi
es Instrucciones de uso
pt Instruções de serviço
it Istruzioni per l'uso
nl Gebruiksaanwijzing
sv Bruksanvisning
da Brugsanvisning
no Bruksanvisning
el Οδηγίες χρήσης
pl Instrukcja obsługi
cs Návod k použití
sk Návod na použitie
ro Instrucțiuni de utilizare
ru Правила пользования
uk Інструкція з експлуатації
ko 사용 설명서

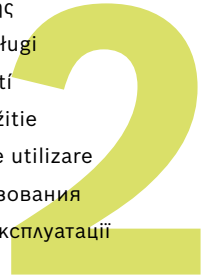

BOSCH



de Inbetriebnahme
en First time use
fr La première utilisation
es Puesta en servicio
pt Primeira utilização
it Messa in funzione
nl Ingebruikneming
sv Idrifttagning
da Ibrugtagning

no Første gangs bruk
el Θέση σε λειτουργία
pl Uruchamianie
cs Uvedení do provozu
sk Uvedenie do prevádzky
ro Prima utilizare
ru Ввод в эксплуатацию
uk Перше використання
ko 처음 사용할 때



de Getränkezubereitung
en Beverage preparation
fr Préparation de boissons
es Preparación de bebidas
pt Preparação de bebidas
it Preparazione delle bevande
nl Toebereiden van dranken
sv Tillredning av drycker
da Tilberedelse af drikke

no Tilberedning av drikker
el Παρασκευή ροφήματος
pl Przygotowanie napoju
cs Příprava nápojů
sk Príprava nápojov
ro Prepararea băuturilor
ru Приготовление напитков
uk Приготування напою
ko 음료 준비



de Reinigen
en Cleaning
fr Nettoyage
es Limpiar
pt Limpar
it Pulizia
nl Reinigen
sv Rengöring
da Rengøring

no Rengjøring
el Καθαρισμός
pl Czyszczenie
cs Čistění
sk Čistenie
ro Curățarea
ru Очистка
uk Очищення
ko 청소



de Entkalken
en Descaling
fr Détartrage
es Descalcificar
pt Descalcificar
it Decalcificare
nl Ontkalken
sv Avkalkning
da Afkalkning

no Avkalking
el Απασβέστωση
pl Odkamianie
cs Odstránění vodního kamene
sk Odstránenie vodného kameňa
ro Decalcifierea
ru Удаление накипи
uk Видалення накипу
ko 석회질 제거

de Stromschlaggefahr!
 en Risk of electric shock!
 fr Risque de choc électrique!
 es ¡Peligro de electrocución!
 pt Perigo de choque eléctrico!
 it Pericolo di scossa elettrica!
 nl Gevaar van elektrische schok!
 sv Risk för elektrisk stöt!
 da Fare for elektrisk støt!
 no Fare for elektrisk støt!
 el Κίνδυνος ηλεκτροπληξίας!

pl Niebezpieczeństwo porażenia prądem!
 cs Nebezpečí úrazu elektrickým proudem!
 sk Nebezpečenstvo zasiahnutia elektrickým prúdom!
 ro Pericol de electrocutare!
 ru Опасность поражения током!
 uk Небезпека ураження електричним струмом!
 ko 감전 위험!



de Verbrennungsgefahr!
 en Risk of burns!
 fr Risque de brûlure!
 es ¡Peligro de quemaduras!
 pt Perigo de queimadura!
 it Pericolo di ustioni!
 nl Verbrandingsgevaar!
 sv Brännskaderisk!
 da Fare for forbrænding!

no Fare for forbrenning!
 el Κίνδυνος εγκαυμάτων!
 pl Niebezpieczeństwo poparzenia!
 cs Nebezpečí opaření!
 sk Nebezpečenstvo oparenia!
 ro Pericol de arsuri!
 ru Риск получения ожогов!
 uk Небезпека опшарення!
 ko 화상 위험!

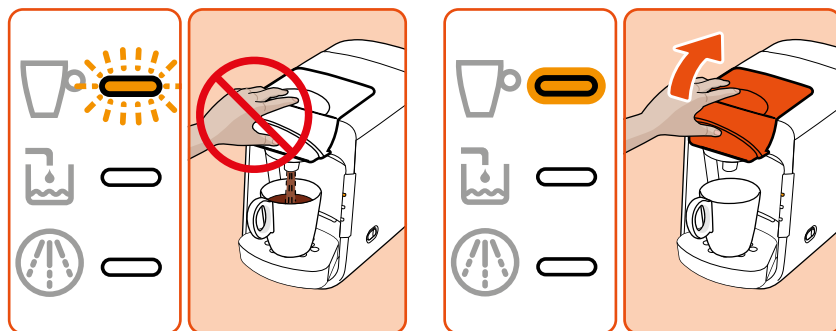

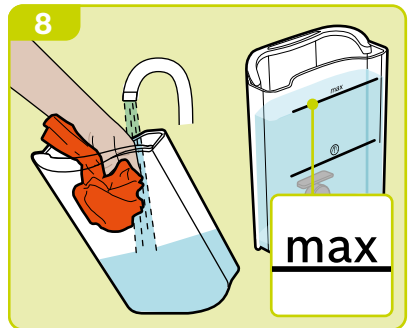
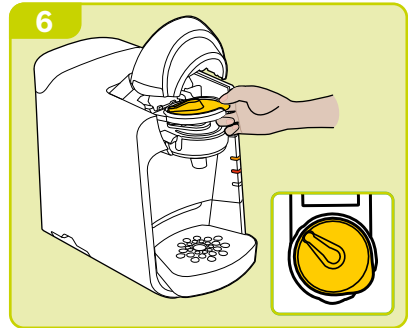
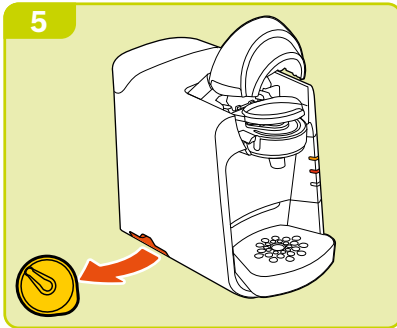
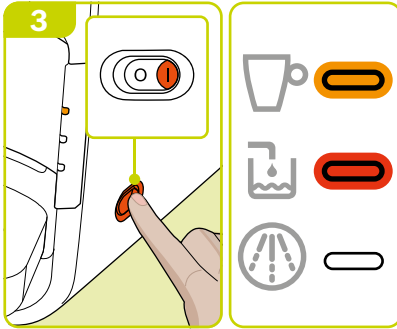
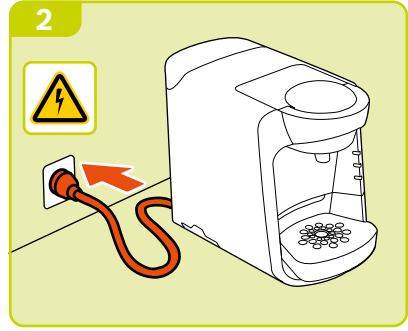
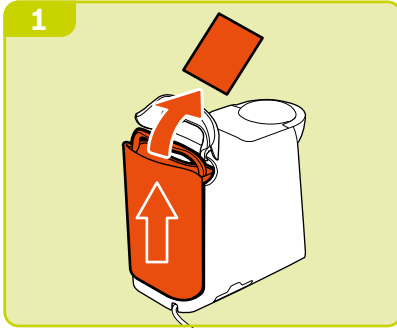

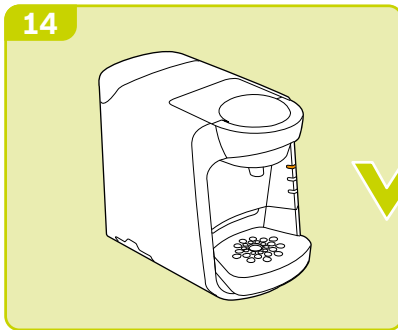
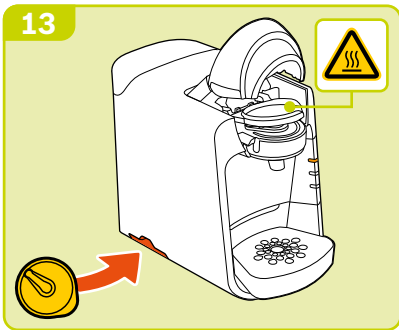
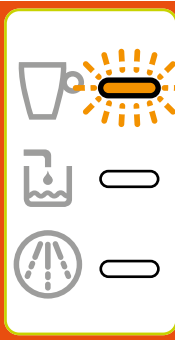
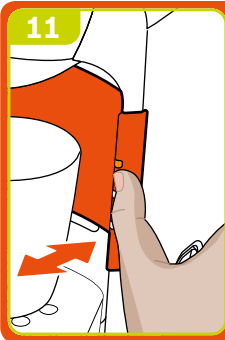
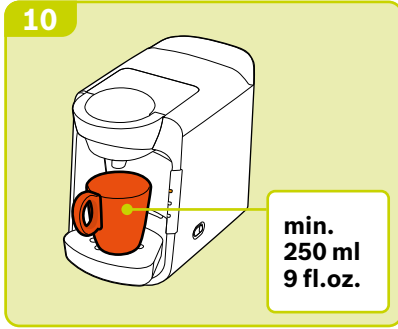
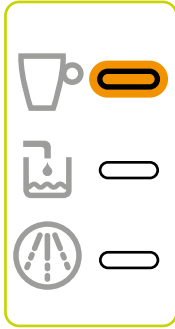
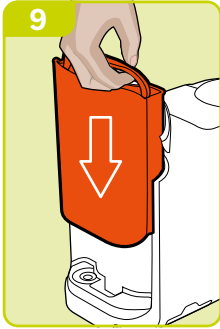

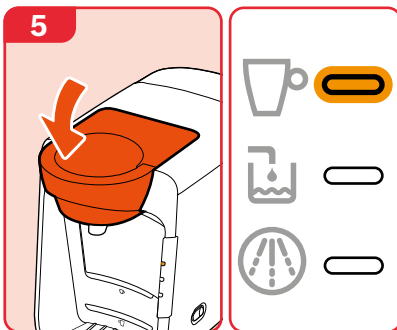
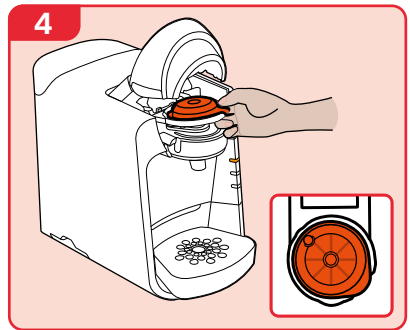
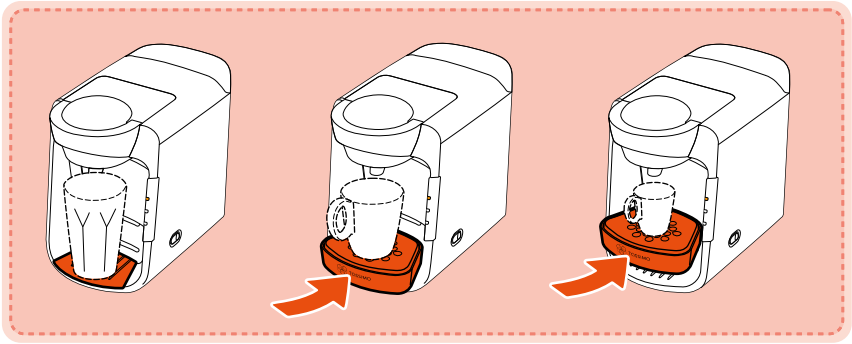
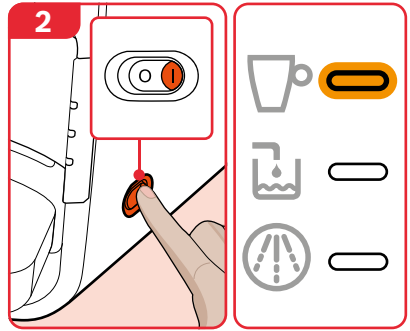
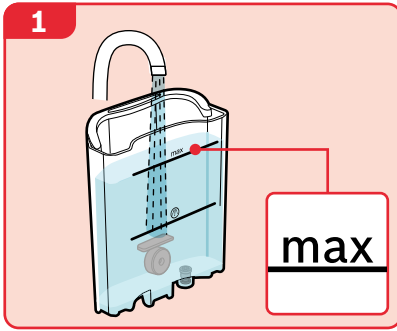

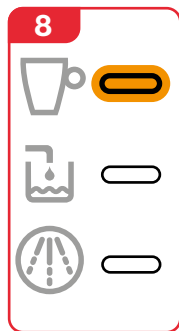
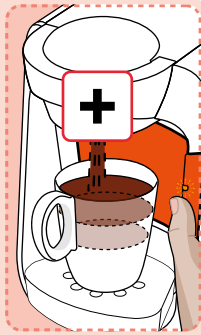
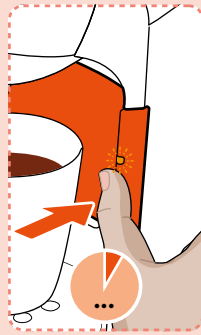
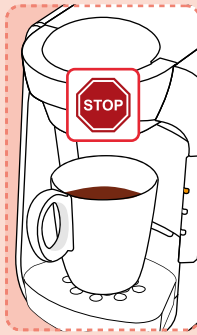
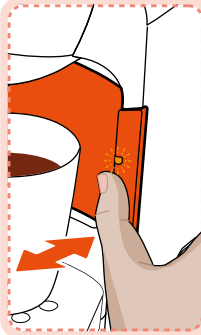
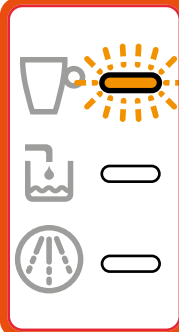
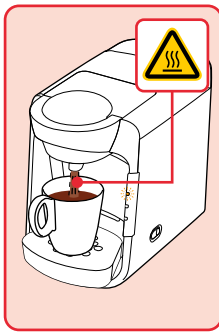
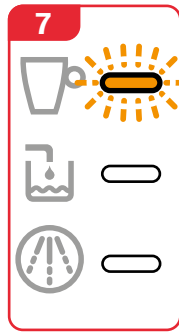
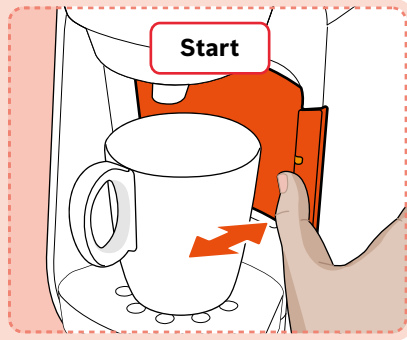
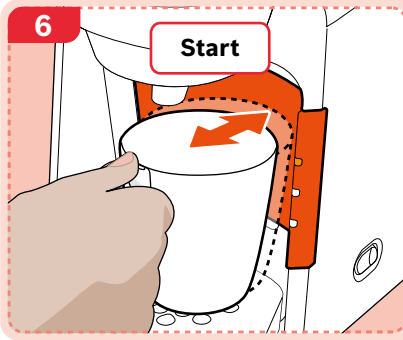

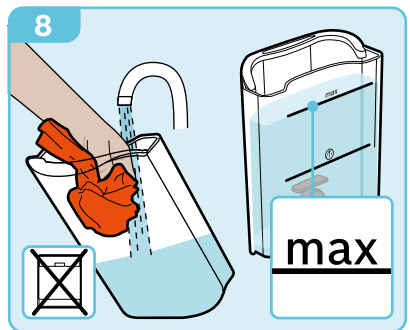
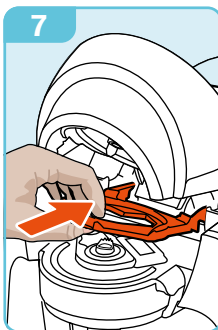
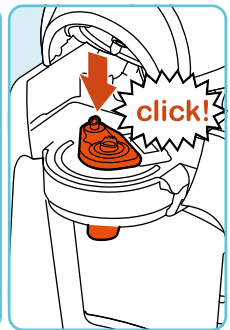
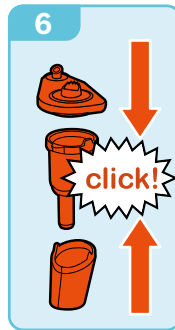
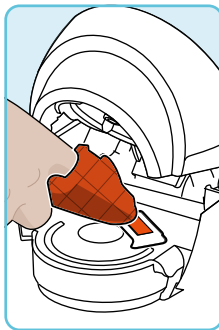
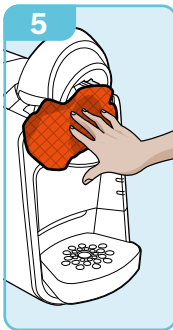
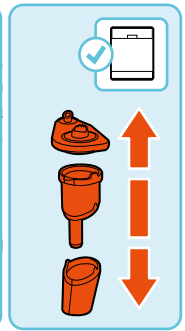
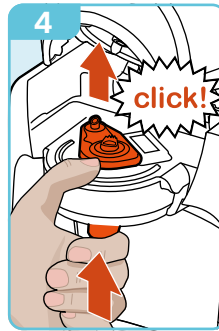
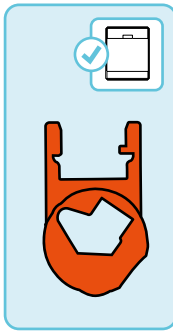
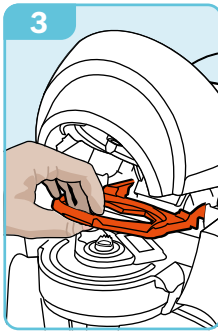
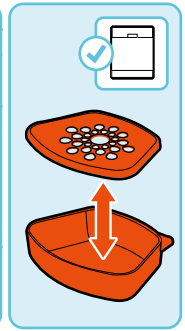
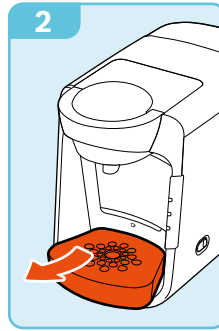
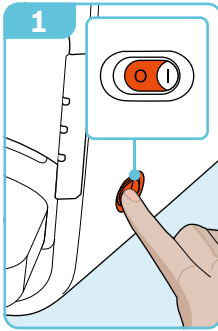

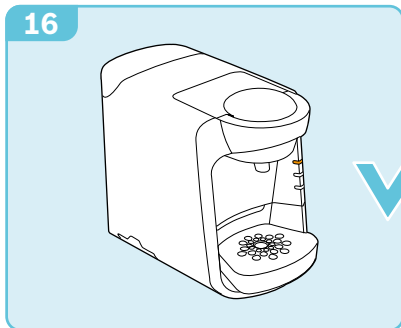
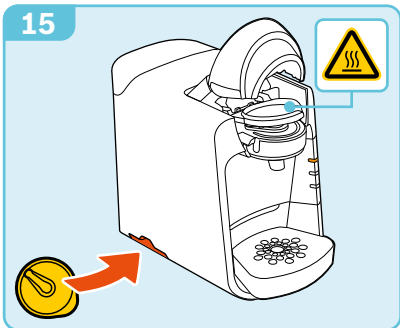
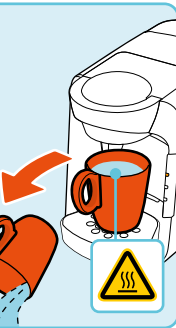
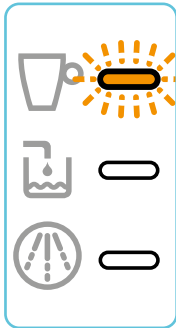
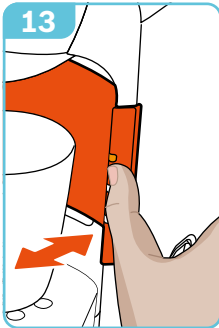
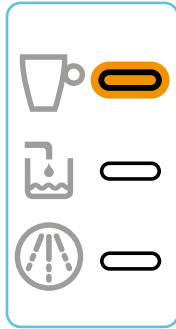
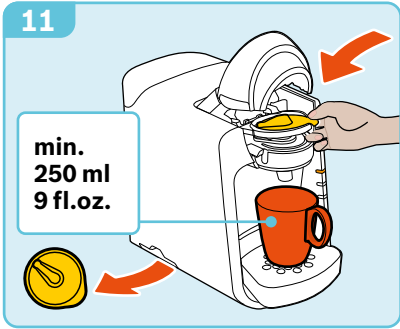
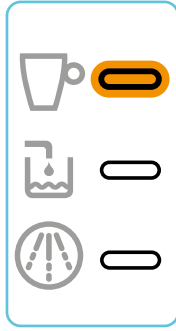
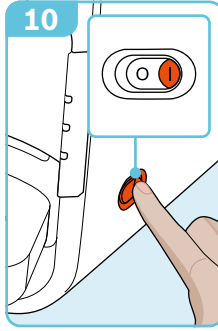
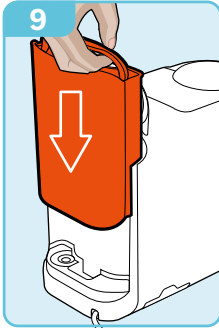

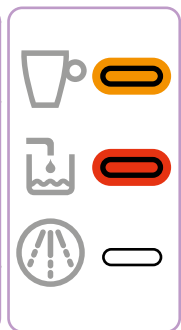
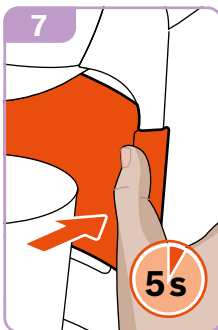
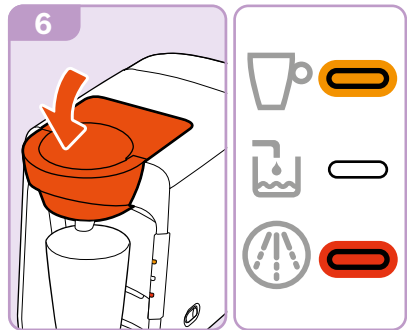
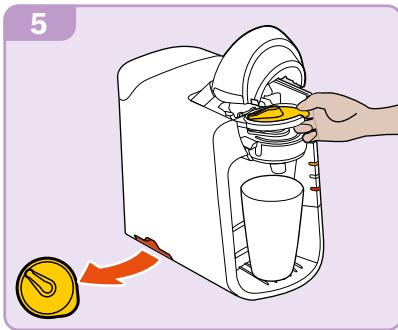
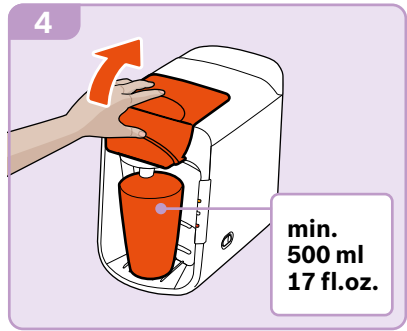
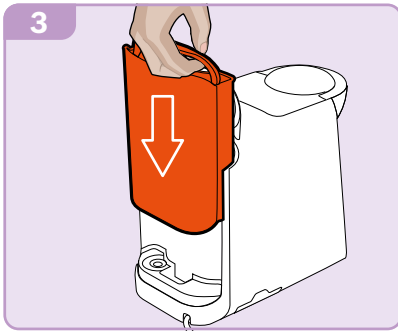
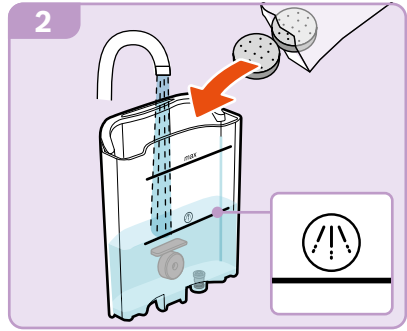
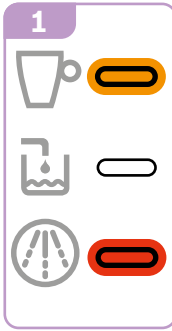

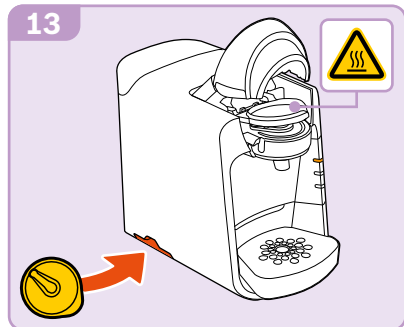
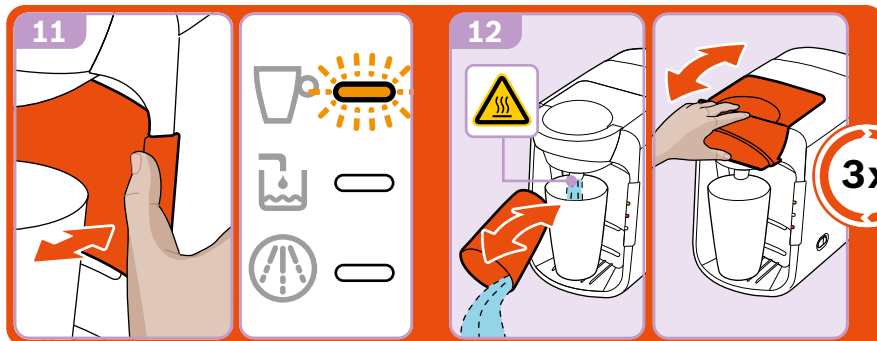
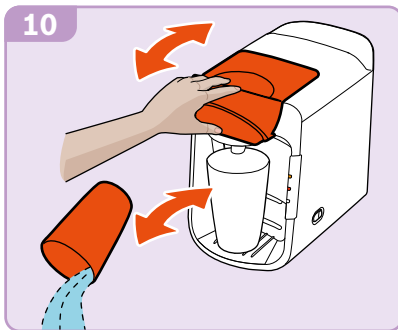
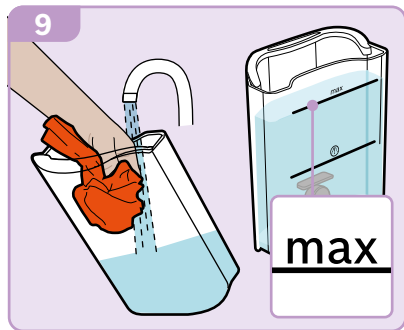



- de** Beachten Sie unbedingt die Sicherheitshinweise in der beiliegenden Gebrauchsanleitung – Teil 1! Dort finden Sie auch detaillierte Informationen zum Gebrauch, Garantiehinweise und Kontaktadressen.
- en** Always follow the safety instructions in the included manual part 1! You will also find detailed information regarding Care and Use, Warranty and Contact information for Customer Service.
- fr** Suivez toujours les consignes de sécurité fournies dans la partie 1 de ce manuel. Vous trouverez également des informations sur l'entretien, l'utilisation, les conditions de garantie et les coordonnées du service client.
- es** Lea atentamente estas instrucciones de uso y la información adjunta antes de utilizar la máquina. También encontrará información detallada referente al uso, garantía y direcciones de contacto.
- pt** Respeite impreterivelmente os avisos de segurança que se encontram na parte 1 das instruções de serviço fornecidas! Encontrará também informações detalhadas a respeito da utilização, garantia e informações de contacto.
- it** Seguire sempre le avvertenze di sicurezza nelle istruzioni per l'uso allegate – Parte 1! È inoltre possibile trovare informazioni dettagliate sull'uso, informazioni sulla garanzia e indirizzi di contatto.
- nl** Neem altijd de veiligheidsaanwijzingen uit deel 1 van de meegeleverde gebruiksaanwijzing in acht! In deze gebruiksaanwijzing vindt u tevens gedetailleerde informatie over het gebruik en de garantie, evenals contactadressen.
- sv** Beakta säkerhetsanvisningarna i del 1 i den bifogade bruksanvisningen. Där hittar du också detaljerade informationer om användningen, garantin och kontaktadresser.
- da** Følg under alle omstændigheder sikkerhedsanvisningerne i den vedlagte brugsanvisning – del 1! Her finder du også detaljer om brug, garantioplysninger og kontaktadresser.
- no** Følg alltid instruksjonene i den vedlagte bruksanvisningen – del 1! Der finner du også detaljert informasjon om bruk, garantivilkår og kontaktadresser.
- el** Προσέξτε οπωσδήποτε τις υποδείξεις ασφαλείας στις συνημμένες οδηγίες χρήσης – μέρος 1! Εκεί θα βρείτε επίσης λεπτομερείς πληροφορίες για τη χρήση, υποδείξεις εγγύησης και διευθύνσεις επικοινωνίας.
- pl** Należy koniecznie przestrzegać instrukcji bezpieczeństwa w dołączonej instrukcji obsługi – część 1! Można znaleźć tam również szczegółowe informacje na temat użytkowania urządzenia, gwarancji oraz adresy kontaktowe.
- cs** Vždy dbejte bezpečnostních pokynů uvedených v přiloženém návodu k použití – část 1! Zde najdete také podrobné informace týkající se použití, záruční podmínky a kontaktní adresy.
- sk** Venujte bezpodmienečne pozornosť bezpečnostným pokynom uvedeným v priloženom návode na použitie – časť 1! Tu nájdete aj podrobné informácie o používaní, záručné podmienky a kontaktné adresy.
- ro** Vă rugăm să respectați obligatoriu instrucțiunile de siguranță prezentate în instrucțiunile de utilizare atașate - partea 1! Acolo găsiți informații detaliate cu privire la utilizare, indicații referitoare la garanție și date de contact.
- ru** Обязательно соблюдайте указания по технике безопасности, которые приведены в части 1 инструкции по эксплуатации! В инструкции Вы найдете подробную информацию об использовании и гарантии, а также контактные данные.
- uk** Обов'язково дотримуйтеся вказівок з техніки безпеки в доданій інструкції з експлуатації – частина 1! Там міститься також детальна інформація щодо використання, вказівки про гарантію та контактні адреси.
- ko** 함께 제공된 사용 설명서의 파트 1에 있는 안전 지침을 반드시 따르십시오. 관리와 사용, 보증 및 고객 서비스 센터의 연락처 정보에 관한 자세한 정보를 찾아볼 수 있습니다.

Robert Bosch Hausgeräte GmbH

Carl-Wery-Str. 34, 81739 München / Germany

www.bosch-home.com

9000 940 661 – 10/13