



Combination steam oven HBC34D.54.



BOSCH

[en] Instruction manual

Important safety information	4	Troubleshooting	19
Causes of damage	5	Replacing the cooking compartment bulb	20
Your new appliance	6	Changing the door seal.....	21
Control panel	6	After-sales service	21
Operating modes	6	E number and FD number	21
Automatic calibration	7	Environmental protection	21
Your accessories	7	Environmentally-friendly disposal.....	21
Accessories	7	Tips for saving energy	21
Inserting accessories	7	Tables and tips	22
Cooking compartment	7	Steam	22
Optional accessories	8	Hot air	22
Before using for the first time	8	Combination	22
Setting the clock	8	Vegetables	22
Setting the water hardness range	8	Side dishes and pulses	23
Before first use	8	Poultry and meat.....	24
Cleaning the accessories before use	9	Fish.....	25
Operating the appliance	9	Bakes, additional soup ingredients, etc.	26
Filling the water tank	9	Dessert, compote	26
Switching on the appliance.....	9	Cakes and pastries	26
Switching off the appliance.....	10	Reheating food.....	28
After each use	10	Defrosting.....	28
Time-setting options	10	Proving dough.....	29
Setting the timer	10	Juicing.....	29
Setting the cooking time.....	10	Preserving	29
Setting a later end time	11	Frozen products.....	29
Setting the clock	11	Test dishes	31
Automatic programmes	12		
Setting a programme	12		
Notes about the programmes	12		
Programme table	13		
Childproof lock	14		
Activating the childproof lock	14		
Deactivating the childproof lock	14		
Basic settings	14		
Automatic safety cut-out	15		
Care and cleaning	15		
cleaning agents.....	16		
Cleaning aid.....	16		
Descaling.....	17		
Removing and fitting the appliance door.....	18		
Cleaning the door panels.....	18		
Cleaning the rails	19		

Additional information on products, accessories, replacement parts and services can be found at www.bosch-home.com and in the online shop www.bosch-eshop.com

Important safety information

Read these instructions carefully. Only then will you be able to operate your appliance safely and correctly. Retain the instruction manual and installation instructions for future use or for subsequent owners.

This appliance is only intended to be fully fitted in a kitchen. Observe the special installation instructions.

Check the appliance for damage after unpacking it. Do not connect the appliance if it has been damaged in transport.

Only a licensed professional may connect appliances without plugs. Damage caused by incorrect connection is not covered under warranty.

This appliance is intended for domestic use only. The appliance must only be used for the preparation of food and drink. The appliance must be supervised during operation. Only use this appliance indoors.

This appliance may be used by children over the age of 8 years old and by persons with reduced physical, sensory or mental capacity or by persons with a lack of experience or knowledge if they are supervised or are instructed by a person responsible for their safety how to use the appliance safely and have understood the associated hazards.

Children must not play with the appliance. Children must not clean the appliance or carry out general maintenance unless they are at least 8 years old and are being supervised.

Keep children below the age of 8 years old at a safe distance from the appliance and power cable.

Always slide accessories into the cooking compartment correctly. See "*Description of accessories*" in the instruction manual.

Risk of fire!

- Combustible items stored in the cooking compartment may catch fire. Never store combustible items in the cooking compartment. Never open the appliance door if there is smoke inside. Switch off the appliance and unplug it from the mains or switch off the circuit breaker in the fuse box.
- A draught is created when the appliance door is opened. Greaseproof paper may come into contact with the heating

element and catch fire. Do not place greaseproof paper loosely over accessories during preheating. Always weight down the greaseproof paper with a dish or a baking tin. Only cover the surface required with greaseproof paper. Greaseproof paper must not protrude over the accessories.

Risk of burns!

- The appliance becomes very hot. Never touch the interior surfaces of the cooking compartment or the heating elements. Always allow the appliance to cool down. Keep children at a safe distance.
- Accessories and ovenware become very hot. Always use oven gloves to remove accessories or ovenware from the cooking compartment.
- Alcoholic vapours may catch fire in the hot cooking compartment. Never prepare food containing large quantities of drinks with a high alcohol content. Only use small quantities of drinks with a high alcohol content. Open the appliance door with care.
- Hot steam may escape during operation. Do not touch the ventilation openings. Keep children away.

Risk of scalding!

- The accessible parts become hot during operation. Never touch the hot parts. Keep children at a safe distance.
- Water in a hot cooking compartment may create hot steam. Never pour water into the hot cooking compartment.
- When you open the appliance door, hot steam can escape. Steam may not be visible, depending on its temperature. When opening, do not stand too close to the appliance. Open the appliance door carefully. Keep children away.
- The water in the evaporator dish is still hot even after the appliance has been switched off. Do not empty the evaporator dish immediately after switching off the appliance. Allow the appliance to cool down before cleaning it.
- Hot liquid may spill over the sides of cooking containers when they are removed from the cooking compartment. Remove hot cooking containers with care and always wear oven gloves.

Risk of injury!

- Scratched glass in the appliance door may develop into a crack. Do not use a glass scraper, or sharp or abrasive cleaning aids or detergents.
- Flammable liquids can catch fire in the cooking compartment when it is hot (explosion). Do not fill the water tank with any flammable fluids (e.g. alcoholic drinks). Only fill the water tank with water or with the descaling solution that is recommended by us.

Risk of electric shock!

- Incorrect repairs are dangerous. Repairs may only be carried out by one of our trained after-sales engineers. If the appliance is faulty, unplug the mains plug or switch off the fuse in the fuse box. Contact the after-sales service.
- The cable insulation on electrical appliances may melt when touching hot parts of the appliance. Never bring electrical appliance cables into contact with hot parts of the appliance.
- Penetrating moisture may cause an electric shock. Do not use any high-pressure cleaners or steam cleaners.
- When replacing the cooking compartment bulb, the bulb socket contacts are live. Before replacing the bulb, unplug the appliance from the mains or switch off the circuit breaker in the fuse box.
- A defective appliance may cause electric shock. Never switch on a defective appliance. Unplug the appliance from the mains or switch off the circuit breaker in the fuse box. Contact the after-sales service.

Causes of damage

Caution!

- Do not place anything on the cooking compartment floor. Do not cover it with aluminium foil. A build-up of heat could damage the appliance.
The cooking compartment floor and the evaporator dish must always be kept clear. Always place ovenware in a perforated cooking container or on a wire rack.
- Aluminium foil in the cooking compartment must not come into contact with the door panel. This could cause permanent discolouration of the door panel.
- Ovenware must be heat and steam resistant. Silicone baking tins are not suitable for combined operation with steam.
- Do not use ovenware that shows signs of rust. Even the smallest spots of rust can lead to corrosion in the cooking compartment.
- When steaming with a perforated cooking container, always insert the baking tray or the solid cooking container underneath. Dripping liquid is caught.
- Do not store moist food in the closed cooking compartment for long periods. It can lead to corrosion in the cooking compartment.
- Fruit juice may leave stains in the cooking compartment. Always remove fruit juice immediately and wipe the cooking compartment with a moist and dry cloth.
- If the door seal is very dirty, the appliance door will no longer close properly during operation. The fronts of adjacent units could be damaged. Always keep the door seal clean and replace when necessary.
- Do not place anything on the open appliance door. The appliance could be damaged.
- Do not carry or hold the appliance by the door handle. The door handle cannot support the weight of the appliance, and could break.
- The cooking compartment in your appliance is made of high grade stainless steel. Improper care can lead to corrosion in the cooking compartment. Refer to the care and cleaning instructions in the instruction manual. Remove food residues from the cooking compartment as soon as the appliance has cooled.

Your new appliance

In this section, you will find information on

- the control panel
- the types of heating
- automatic calibration

Control panel

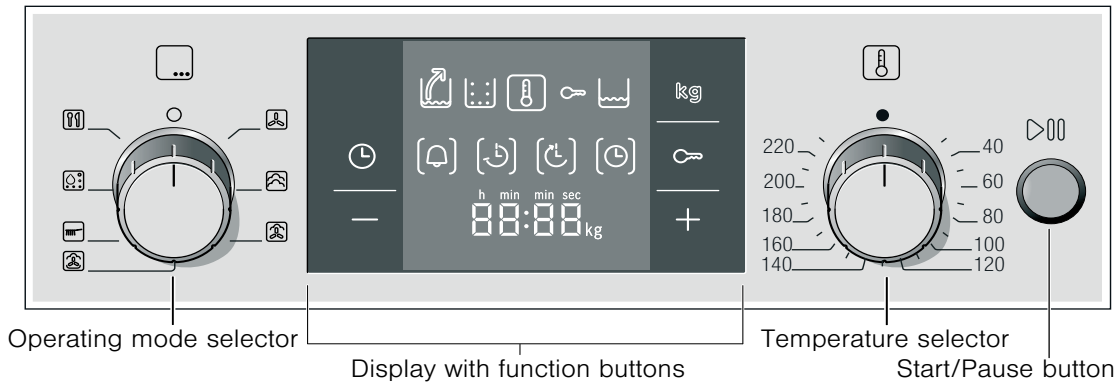

Control element		Use
Operating mode selector		Switches the appliance on and off Selects the operating mode
Function buttons		Press briefly: Selects time-setting options (see section: Time-setting options) Press and hold when the appliance is off: Selects the basic settings (see section: Basic settings)
		Selects the weight of the food for a programme (see section: Automatic programmes)
		Switches childproof lock on and off (see section: Childproof lock)
		Changes the values for clock, cooking time, weight etc.
Temperature selector		Selects a temperature
Start/Pause button		Press briefly: starts or interrupts (Pause)cooking Press and hold: ends cooking

Pop-out control knob

The operating mode and temperature selectors are pop-out

knobs. Simply push the appropriate control knob to pop it in or out.

Operating modes

You can use the operating mode selector to set your appliance for various different applications.

Operating mode		Used for
Hot air	30 - 230 °C	For moist cakes, sponges and pot roasts. A fan in the back wall of the oven distributes the heat evenly inside the cooking compartment.
Steam	35 - 100 °C	For vegetables, fish, side dishes, for juicing fruit and for blanching. For proving dough (at 35 °C). The food is completely surrounded by steam.
Combination	120 - 230 °C	For meat, bakes, and pastries. Hot air and steam are combined.
Reheat	100 - 180 °C	For plated meals and baked items. Cooked food is gently reheated. The steam ensures that the food does not dry out.
Cleaning aid		Makes cleaning the cooking compartment easier (see section: Cleaning aid)
Descaling		For descaling the water system and the evaporator dish (see section: Descaling)
Automatic programmes		Selects a programme (see section: Automatic programmes)

Automatic calibration

The boiling temperature of water depends on the air pressure. During calibration, the appliance is adapted to the pressure conditions in the location where it is installed. This happens automatically when you first use the appliance (see section: First use). More steam develops than usual.

It is important that the appliance steams without interruption for 20 minutes at 100 °C. Do not open the appliance door during this time.

If the appliance was not able to calibrate itself automatically (for example, because the appliance door was opened), the

calibration process is carried out again during the next cooking operation.

After moving house

So that the appliance automatically adjusts itself to its new location, you must reset the appliance to the factory settings (see section: Basic settings) and repeat the initial start-up process (see section: First use).

After a power cut

The appliance saves the calibration settings even in the event of a power cut or disconnection from the mains. Recalibration is not necessary.

Your accessories

The accessories supplied with your appliance are suitable for making many dishes. Ensure that you always insert the accessories into the cooking compartment the right way round.

Accessories

Use only the accessories supplied with the product or available from the after-sales service. They are specially designed for your appliance.

Your appliance is equipped with the following accessories:

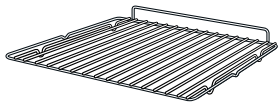

Wire rack

For ovenware, cakes and ovenproof dishes, and for roasting

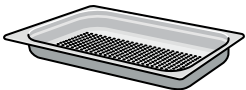

Cooking container, perforated, GN 1/3, 40 mm deep

For steaming vegetables, juicing berries and defrosting



Cooking container, solid, GN 1/3, 40 mm deep

For cooking rice, pulses and cereals

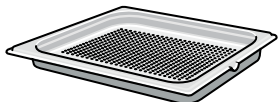

Cooking container, perforated, GN 2/3, 40 mm deep

for the steaming of whole fish or large quantities of vegetables, for juicing berries, etc.



Cooking container, solid, GN 2/3, 28 mm deep (baking tray)

For baking tray bakes and for catching dripping liquid during steaming

You can buy accessories from the after-sales service, from specialist retailers or online.

Note: The cooking containers may warp during and after cooking. This is caused by the considerable temperature differences acting on the accessories. It may occur if only a part of the accessory is occupied with food or if you place frozen items, such as pizza, on the accessory. Once accessories cool down again, they regain their original shape. This does not affect their function.

Inserting accessories

The accessories are equipped with a locking function. The locking function prevents the accessories from tilting when they are pulled out. The accessories must be inserted into the cooking compartment correctly for the tilt protection to work properly.

When inserting the wire rack, check

- that the lug (a) is pointing downwards
- that the safety lug on the wire rack is at the back and facing upwards.

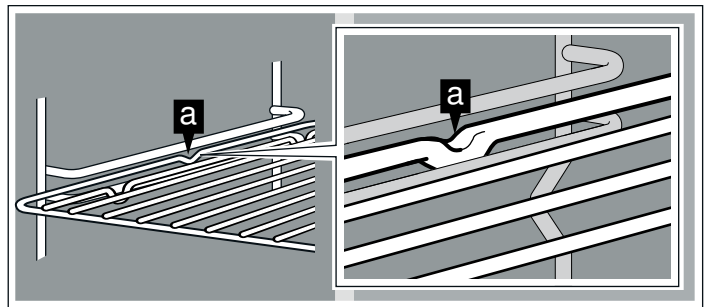

When inserting the cooking container, ensure that the lug (a) is facing downwards.

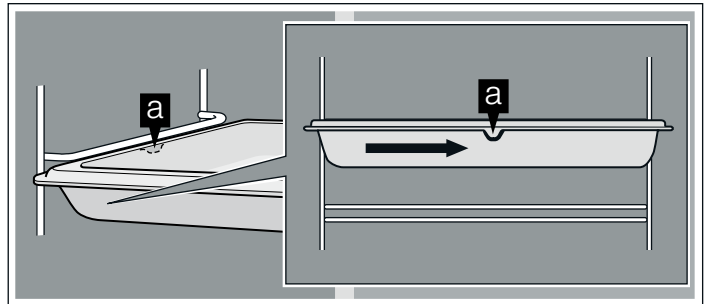

Cooking compartment

The cooking compartment has four shelf positions. The shelf positions are counted from the bottom up.

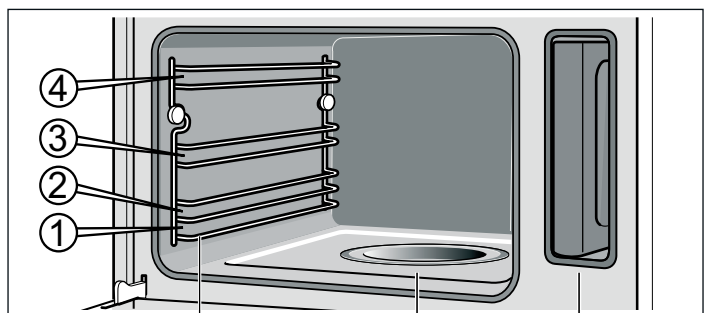

Rails for accessories

Evaporator dish

Tank recess with water tank

Caution!

- Do not place anything on the cooking compartment floor. Do not cover it with aluminium foil. A build-up of heat could damage the appliance.
The cooking compartment floor and the evaporator dish must always be kept clear. Always place ovenware in a perforated cooking container or on a wire rack.
- Do not slide any accessories between the shelf positions, or they may tip.

Optional accessories

You can obtain further accessories from specialist retailers:

Accessories	Order no.
Cooking container, solid, GN 2/3, 40 mm deep	HEZ36D453
Cooking container, perforated, GN 2/3, 40 mm deep	HEZ36D453G

Accessories	Order no.
Cooking container, solid, GN 2/3, 28 mm deep (baking tray)	HEZ36D452
Cooking container, solid, GN 1/3, 40 mm deep	HEZ36D153
Cooking container, perforated, GN 1/3, 40 mm deep	HEZ36D153G
Porcelain cooking container, solid, GN 2/3	HEZ36D353P
Porcelain cooking container, solid, GN 1/3	HEZ36D153P
Grease filter	HEZ36DF
Wire rack	HEZ36DR4
Roasting set	HEZ36DB4
Cleaning sponge	643 254
Descaler	311 138
Honeycomb microfibre cloth	460 770

Before using for the first time

In this section you will find out which steps are required before using the appliance for the first time:

- Setting the clock
- Setting the water hardness range
- Starting the appliance for the first time
- Cleaning the accessories before use

Setting the clock

After the power has been connected, the  symbol and **00:00** light up in the display. Set the clock.

1. Press the  button.
The time **12:00** is shown in the display.
2. Use the **+** or **-** button to set the clock.
After a few seconds, the time which has been set is adopted.

Setting the water hardness range

Caution!

The appliance may become damaged due to the use of unsuitable liquids.

Do not use distilled water, highly chlorinated tap water (> 40 mg/l) or other liquids.

Only use cold, fresh tap water, softened water or uncarbonated mineral water.



The water hardness "medium" is the default setting. Change the value if your water is softer or harder.

You can check the water hardness with the test strips supplied or ask your water supplier.

Notes

- If your water is very hard, we recommend that you use softened water.
- If you use only softened water, you can set your appliance to the "softened" water hardness range.
- If you use mineral water, set the water hardness to hard.
- If you use mineral water, you must only use non-carbonated mineral water (see section "Filling and emptying the water tank").

You can change the water hardness in the basic settings when the appliance is switched off.



1. If required, turn the operating mode selector to **O** to switch off the appliance.
2. Press and hold the  button until **c 0 3** appears in the display.
3. Press the  button repeatedly until **c 5 2** appears ("medium" water hardness).
4. Use the temperature selector to set the water hardness.

Water hardness	Setting symbol
softened	c 5 0
1-soft	c 5 1
2-medium	c 5 2
3-hard	c 5 3
4-very hard	c 5 4

5. Press and hold the  button.
Your setting is saved.

Before first use

Before first use, heat the empty appliance for 20 minutes at 100 °C using  Steam. Do not open the appliance door during this time. The appliance is automatically calibrated (see section: Automatic calibration).

1. Fill and insert the water tank (see section: Filling the water tank).
Before using for the first time, moisten the seal in the tank cover with a little water.
2. Turn the operating mode selector to  Steam.
3. Turn the temperature selector to 100 °C.
4. Press the  button.

The appliance heats up to 100 °C. The cooking time (20 minutes) does not start to count down until the set temperature has been reached. Do not open the appliance door during this time.

The cooking operation ends automatically and an audible signal sounds.

- To switch off the appliance, turn the operating mode and temperature selectors to 0.
Leave the appliance door ajar until the appliance has cooled down.

Cleaning the accessories before use

Using soapy water and a soft cloth, clean the accessories thoroughly before first use.

Operating the appliance

In this section, you can read about

- how to fill the water tank
- how to switch the appliance on and off
- what to note after each cooking operation

Filling the water tank

When you open the appliance door, you will see the water tank on the right-hand side.

Caution!

Use of unsuitable liquids may damage the appliance

- Only use fresh tap water, softened water or uncarbonated mineral water.
- If your tap water is very hard, we recommend that you use softened water.
- Do not use distilled water, highly chlorinated tap water (> 40 mg/l) or other liquids.

You can obtain information about your tap water from your water supplier. The water hardness can be checked with the test strips enclosed.

Fill the water tank before each use:

- Open the appliance door and take out the water tank (fig. A).
- Fill the water tank with cold water up to the "max" mark (fig. B).

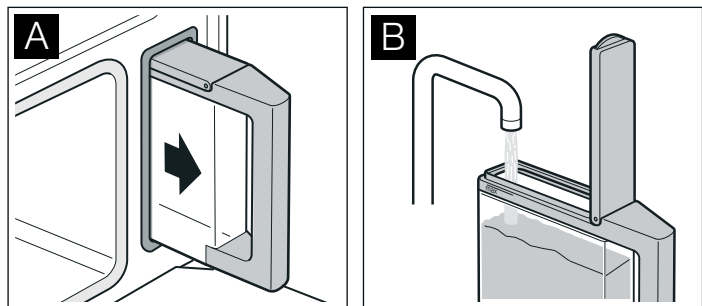

- Close the tank cover until you feel it engage.
- Slide in the water tank all the way (fig. C).

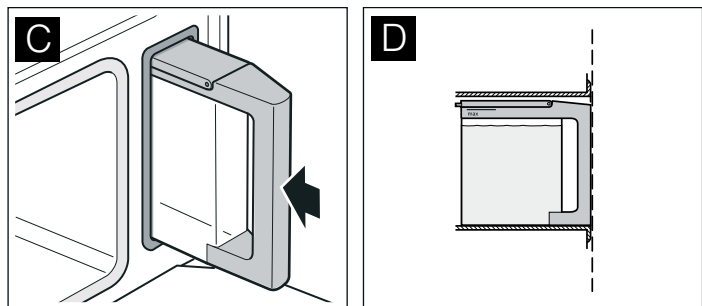

The tank must be flush with the water tank recess (fig. D).

Switching on the appliance

⚠ Risk of scalding!

When you open the appliance door and remove the cooking containers, hot liquids may squirt out because the cooking containers may have warped. When opening, do not stand too close to the appliance. Open the appliance door carefully.

Remove the cooking container carefully. Keep children at a safe distance.

Note: Always use the cooking container and wire rack in their standard position (not the other way up).



- Turn the operating mode selector to the required operating mode.
- Turn the temperature selector to set the temperature.

Operating mode	Temperature range	Default cooking time
Hot air	30 - 230 °C	-
Steam	35 - 100 °C	20 minutes
Combination	120 - 230 °C	30 minutes
Reheat	100 - 180 °C	10 minutes

For operating modes involving steam, you must now set a cooking time (see also section: Time-setting options). A default cooking time then appears in the display.

- Press repeatedly until the brackets are around the Cooking time.
- Use the + or - button to set the cooking time.
- Press the to start cooking.

The appliance heats up.

The symbol lights up until the set temperature has been reached and each time the temperature rises.

In the Steam operating mode, the cooking time does not start counting down until the heating-up time has finished.

If the cooking operation does not start, but an audible signal sounds, you have set a temperature outside of the possible temperature range. Check the temperature range for the operating mode.

Changing the temperature

You can change the temperature at any time. To do this, turn the temperature selector.

If you set a temperature that lies outside the possible temperature range, the cooking operation is interrupted (Pause).

Pause

Briefly press the to interrupt cooking (pause). The cooling fan may continue running. Press the to start. If you open the appliance door during cooking, operation is interrupted. Close the appliance door and press the to restart.

If you have switched on the basic setting "Continue operation after closing door", restarting is not required (see section: Basic settings).

Display



If the water tank is empty, a signal sounds and the symbol (Fill water tank) appears. Cooking is interrupted.

- Open the appliance door carefully.
Hot steam will escape.
- Remove the water tank, fill up to the "max" mark and slide the tank back in.
- Press the button.

Switching off the appliance

Risk of scalding!

Hot steam may escape when the appliance door is opened. Open the appliance door carefully during or after cooking. When opening the door, do not lean over it. Ensure that, depending on the temperature, steam is not visible.

Press and hold the  button to end cooking. If you have set a cooking time, cooking is ended automatically. An audible signal sounds. Press the  button to stop the audible signal.

To switch off the appliance, turn the operating mode and temperature selectors back to .

The cooling fan may continue to run when you open the appliance door.

After each use

Emptying the water tank.

1. Open the appliance door carefully.
Hot steam will escape.

2. Remove and clean the water tank.
3. Thoroughly dry the seal in the tank cover and the tank recess in the appliance.

Caution!

Do not dry the water tank in the hot cooking compartment. This will damage the water tank.

Drying the cooking compartment

Risk of scalding!

The water in the evaporator dish may still be hot. Allow it to cool before wiping.

1. Leave the appliance door ajar until the appliance has cooled down.
2. Once it has cooled down, wipe out the cooking compartment and the evaporator dish with the enclosed cleaning sponge and dry well with a soft cloth.
3. Remove food residues from the cooking compartment as soon as the appliance has cooled. Burnt-on remains will be much harder to remove later.
4. Wipe kitchen units or handles if condensation has formed on them.

Time-setting options

Your appliance has many different time-setting options. You can use the  button to access the menu and switch between the individual options.

All the time symbols are lit during the time when you can make settings. The [] brackets show you which time-setting function you have currently selected.



A time-setting function which has already been set can be changed directly with the **+** or **-** button, when its time symbol is in brackets.

Checking the time-setting option

Press the  button repeatedly until the brackets are around the appropriate symbol. The display shows the value for a few seconds.

Setting the timer

You can use the timer as a kitchen timer. It runs independently of the cooking operation. The timer has its own signal. In this way, you can tell whether it is the timer or a cooking time which has elapsed.

1. Press the  button.
The time symbols in the display light up, the brackets are around .

2. Use the **+** or **-** button to set the timer.
Default value for the **+** button = 10 minutes
Default value for the **-** button = 5 minutes
After a few seconds, the timer duration set is adopted. The timer starts. The  symbol for the timer appears, and the time starts counting down.

Changing the timer duration

Use the **+** or **-** button to change the timer duration. After a few seconds, the change is adopted.

Once the timer duration has elapsed

An audible signal sounds. **00:00** appears in the display. Switch the timer off with the  button.

Cancelling the timer duration

Use the **-** button to set the timer duration to **00:00**. After a few seconds, the change is adopted.



Setting the cooking time

If you set the cooking time for your dish, the operation will end automatically after this time. The appliance stops heating.

For operating modes involving steam, you must always set a cooking time.

Example in the picture: cooking time of 45 minutes.

Prerequisite: An operating mode and temperature have been set.

1. Press  repeatedly until the brackets are around the  Cooking time.

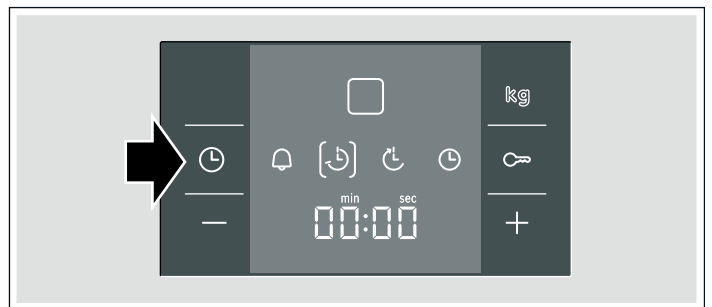



The time symbols light up. **00:00** appears in the display.

2. Use the **+** or **-** button to set the cooking time.
Default value for the **+** button = 30 minutes
Default value for the **-** button = 10 minutes



3. Press the  button.

The appliance heats up. The cooking time starts counting down in the display. The  symbol lights up.

In the  Steam operating mode, the cooking time does not start counting down until the heating-up time has finished.

Changing the cooking time

Use the **+** or **-** button to change the cooking time. If the timer has been set, first press the  button.

After a few seconds, the change is adopted.

The cooking time has elapsed

An audible signal sounds. The appliance stops heating. Press the  button to stop the audible signal. To switch off the appliance, turn the operating mode and temperature selectors back to the 0 position. Open the appliance door carefully. Hot steam will escape.

Cancelling the cooking time

Use the **-** button to set the cooking time to **00:00**. After a few seconds, the change is adopted. If the timer has been set, first press the  button.

Setting a later end time

You can delay the time at which you wish your dish to be ready. The appliance starts automatically and is ready at the desired time. You can, for example, put your dish in the cooking compartment in the morning and set the cooking time so that it is ready at lunch time.

Ensure that food is not left in the cooking compartment for too long as it may spoil.



For some programmes it is not possible to change the end time.

In the  Steam operating mode, the cooking time does not start counting down until the heating-up time has finished. The selected end time is delayed by the length of the heating-up time.

Example in the picture:
it is 10:30, the dish will take 45 minutes to cook but should be ready at 12:30.

Prerequisites:

An operating mode and temperature have been set.

1. Press  repeatedly until the brackets are around the  Cooking time.

2. Use the **+** or **-** button to set the cooking time.

3. Press the  button.

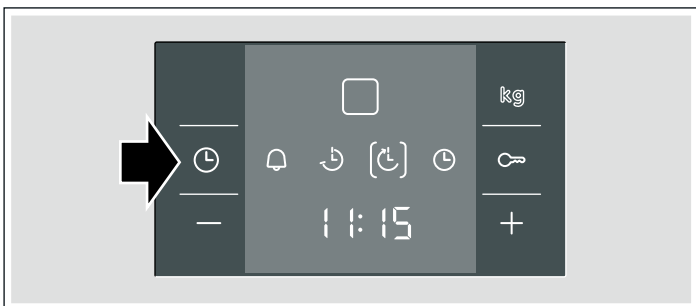

The brackets are around  (End time). The time when the dish will be ready is displayed.



4. Use the **+** button to delay the end time.



5. Press the  button.

The appliance switches to standby. The  end time is shown in the display. Cooking starts at the right time. The cooking time starts counting down in the display.

Changing the end time



Use the **+** or **-** button to change the end time. If the timer has been set, first press the  button repeatedly until the  end time appears.

After a few seconds, the change is adopted. Do not change the end time if the cooking time has already started to elapse. The cooking result would no longer be correct.

The cooking time has elapsed

An audible signal sounds. The appliance stops heating. Press the  button to stop the audible signal. To switch off the appliance, turn the operating mode and temperature selectors back to the 0 position. Open the appliance door carefully. Hot steam will escape.

Cancelling the end time



Use the **-** button to set the end time back to the current time. If the timer has been set, first press the  button repeatedly until the  cooking time appears.

After a few seconds, the change is adopted. The selected cooking time starts counting down straight away.

Setting the clock

Example: changing from summer to winter time.



No other time-setting function should be set.

1. Press the  repeatedly until the  Clock symbol appears.

2. Use the **+** or **-** button to set the clock.

After a few seconds, the time which has been set is adopted.

After a power cut

After a power cut, the  and **00:00** symbols light up in the display. Press the  button. Use the **+** or **-** button to set the clock. After a few seconds, the time which has been set is adopted.

Hiding the clock

You can hide the clock. It is then only visible when the appliance is in operation (see section: Basic settings).

Automatic programmes

You can prepare food really easily with 40 different programmes.

In this section, you will find out

- how to set one of the automatic programmes
- hints and tips on the programmes
- which programmes you can set

Setting a programme

Select the appropriate programme from the programme table. Follow the instructions for the programmes.

1. Turn the operating mode selector to .
The first programme **P 9** appears in the display.
2. Use the **+** or **-** button to set the programme.



3. Press the **kg** button.
A default weight appears in the display.
For some programmes, you do not have to enter a weight. If this is the case, **0:00** kg appears.
4. Use the **+** or **-** button to set the weight of the food.



5. Press the  button.
The programme cooking time counts down in the display.

Setting a later end time

You can delay the end time for some programmes. The programme will be started later and finish at the desired time (see Section: Time-setting options).

Cancelling the programme

Turn the operating mode selector back to **o**.

End of the programme

An audible signal sounds. Cooking has finished. To switch off the appliance, turn the operating mode selector back to **o**.

Risk of scalding!

Hot steam may escape when the appliance door is opened. Open the appliance door carefully during or after cooking. When opening the door, do not lean over it. Ensure that, depending on the temperature, steam is not visible.

Notes about the programmes

All programmes are designed for cooking on one level.

The cooking result can vary according to the size and quality of the food.

Ovenware

Use the suggested ovenware. All meals have been tested using this ovenware. The cooking result may change if you use different ovenware.

When cooking in the perforated cooking container, also insert the solid cooking container at level 1. Dripping liquid is caught.

Amount/weight

Do not fill the food more than 4 cm deep in the accessories.

The automatic programmes require the weight of the food. With individual pieces, always enter the weight of the largest piece. The total weight must be within the specified weight range.

Cooking time

After the programme is started, the cooking time is displayed. It may change during the first 10 minutes, as the heating-up time depends, among other things, on the temperature of the food and the water.

Preparing vegetables P1 - P8

Do not season vegetables until after cooking.

Preparing rice P9 - P 10

Weigh the rice and add to the water in a ratio of 1:1.5. Enter the weight excluding liquid. Stir the rice after cooking. The remaining water is quickly absorbed.

Cooking poultry P 11 - P 13

Do not place chicken breasts or chicken portions on top of each other in the ovenware. The chicken portions can be marinated beforehand.

Slow cooking sirloin P 15

With sirloin, it is recommended that you use a thick piece. Sear the meat well beforehand.

Slow-cooked leg of lamb P 19

Sear the meat well beforehand.

Steaming fish P 21 - P 22

When preparing fish, grease the perforated cooking container.

Do not place whole fish or fish fillets on top of each other. Enter the weight of the heaviest fish and choose pieces as similar in size as possible.

Baking plaited loaf P 24

Allow the yeast dough to prove in the combination steam oven for half an hour using Steam at 40 °C.

Preparing rice pudding P 25

Weigh the rice and add 2.5 times the amount of milk. Ensure the level of rice and milk in the accessory is no higher than 2.5 cm. Stir after cooking. The remaining milk is quickly absorbed.

Preparing yoghurt P 26

Heat the milk to 90 °C on the hob. Then leave to cool to 40 °C. If you are using UHT milk, you do not need to heat it.

Stir in one to two teaspoons of natural yoghurt per 100 ml milk, or the corresponding amount of yoghurt culture into the milk. Pour the mixture into clean jars and seal them.

After preparation, leave the glasses to cool in the refrigerator.

Baking bread P 27 - P 28

The programmes are designed for baking loaves of bread without a tin. The dough should not be too soft. Score the dough several times with a sharp knife to a depth of approx. 1 cm before baking.

Baking bread rolls P 29

The rolls should all be the same weight. Enter the weight of an individual bread roll.

Defrosting P 35 - P 37

When freezing, lay the food as flat as possible and in portion-sized pieces at -18 °C. Do not freeze excessively large quantities. Once defrosted, food will not keep for as long and spoils more quickly than fresh food.

Leave the food to defrost in the freezer bag, on a plate or on the perforated cooking container. Always insert the baking tray underneath. The food is then not left lying in the defrost water and the cooking compartment remains clean.

All defrost programmes apply to raw food.

If necessary, the meal can occasionally be split apart or pieces which have already defrosted can be removed from the appliance.

After defrosting, allow the food to stand for a further 5-15 minutes to come up to room temperature.

Health risk!

When defrosting food from animal sources, you must remove the liquid that escapes during defrosting. It must never come into contact with other food. Bacteria could be transferred. After defrosting, operate the combination steam oven for 15 minutes using Hot air at 180 °C.

Defrosting fish fillets (P 35): Never place the fish fillets on top of each other.

Defrosting whole poultry (P 36): Remove the packaging before defrosting. Leave the poultry to stand after defrosting. With

large poultry (e.g. small turkeys), you can remove the giblets after approximately 30 minutes standing time.

Disinfecting bottles P 38

Always clean the bottles with a bottle brush immediately after drinking. Then clean them in the dishwasher.

Place the bottles in the perforated cooking container so that they do not touch one another.

Dry the bottles with a clean cloth after sterilising. The process corresponds to normal sterilisation by boiling.

Preserving P 39

This programme is suitable for fruits with a stone and core and for vegetables (except beans).

Blanch pumpkin before preserving.

The programme is designed for 1 litre jars.

After the end of the programme, open the appliance door to prevent cooking from continuing. Leave the jars to cool down for a few minutes in the cooking compartment.

Cooking eggs P 40

Pierce the eggs before cooking. Do not place eggs on top of each other. Size M corresponds to a unit weight of approx. 50 g.

Programme table

This section contains all your combination steam oven programmes. Follow the instructions for the programmes.

Programme	Notes	Accessories	Level
P 1*	Steam cauliflower florets	florets of equal size	perforated cooking container + 3 baking tray 1
P 2*	Steam broccoli florets	florets of equal size	perforated cooking container + 3 baking tray 1
P 3*	Steam green beans	-	perforated cooking container + 3 baking tray 1
P 4*	Steam sliced carrots	slices, approx. 3 mm thick	perforated cooking container + 3 baking tray 1
P 5*	Steam white asparagus	-	perforated cooking container + 3 baking tray 1
P 6	Steam frozen mixed vegetables	-	perforated cooking container + 3 baking tray 1
P 7*	Boiled potatoes	medium-sized, quartered, weight per piece 30 - 40 g	perforated cooking container + 3 baking tray 1
P 8*	Unpeeled boiled potatoes	medium-sized, dia. 4 - 5 cm	perforated cooking container + 3 baking tray 1
P 9	Long grain rice	max. 0.75 kg	solid cooking container 2
P 10	Basmati rice	max. 0.75 kg	solid cooking container 2
P 11	Fresh chicken	total weight 0.7 - 1.5 kg	wire rack + baking tray 2
P 12	Fresh chicken portions	0.04 - 0.35 kg each	wire rack + baking tray 2
P 13	Steam fresh chicken breast	Total weight 0.2 - 1.5 kg	perforated cooking container + 3 baking tray 1
P 14*	Fresh pot roast joints	1 - 1.5 kg	baking tray 2
P 15	Slow cook fresh sirloin (medium)	total weight 1 - 2 kg	baking tray 2
P 16*	Fresh lean joint of veal	1 - 2 kg	wire rack + baking tray 2
P 17*	Stuffed breast of veal	1 - 2 kg	wire rack + baking tray 2
P 18*	Fresh joint of pork (neck), boned	0.8 - 2 kg	wire rack + baking tray 2
P 19	Fresh leg of lamb, boned, slow cook (medium)	1 - 2 kg	baking tray 2
P 20	Meat loaf made from fresh minced meat	Total weight 0.5 - 2 kg	baking tray 2
P 21	Steam whole, fresh fish	0.3 - 2 kg	perforated cooking container + 3 baking tray 1

* You can delay the end time for this programme



Programme	Notes	Accessories	Level
P22	Steam fresh fish fillet	max. 2.5 cm thick	perforated cooking container + 3 baking tray 1
P23	Blue mussels	-	perforated cooking container + 3 baking tray 1
P24	Plaited loaf	0.6 - 1.8 kg	baking tray + greaseproof 2 paper
P25	Rice pudding	-	baking tray 2
P26	Yogurt in glass jars	-	jars + 2 perforated cooking container
P27*	Bake multigrain bread	0.6 - 2 kg	baking tray + greaseproof 2 paper
P28*	Bake rye bread	0.6 - 2 kg	baking tray + greaseproof 2 paper
P29*	Bake fresh bread rolls	Weight per piece 0.05 - 0.1 kg	baking tray + greaseproof 2 paper
P30*	Reheat 1 portion	-	wire rack 2
P31*	Reheat side dishes	-	baking tray 2
P32*	Reheat cooked vegetables	-	baking tray 2
P33*	Reheat cooked pizza (thin base)	-	wire rack + baking tray 3
P34*	Reheat cooked pizza (deep-pan base)	-	wire rack + baking tray 3
P35	Defrost fish fillet	max. 2.5 cm thick	perforated cooking container + 3 baking tray 1
P36	Defrost whole poultry	max. 1.5 kg	perforated cooking container + 3 baking tray 1
P37	Defrost berries	-	perforated cooking container + 3 baking tray 1
P38*	Disinfect bottles	-	perforated cooking container 2
P39	Preserving	in 1 litre jars	perforated cooking container + 3 baking tray 1
P40*	Soft-boiled eggs	Eggs, size M, max. 1 kg	perforated cooking container + 3 baking tray 1

* You can delay the end time for this programme



Childproof lock

The appliance has a childproof lock to prevent children switching it on accidentally or changing a setting.

Activating the childproof lock

Press and hold the  button for approx. 4 seconds until the  symbol appears.

The control panel is locked.

Even with the childproof lock activated, you can switch the appliance off, set the timer and switch off the audible signal using the  button or pressing and holding the  button.







Deactivating the childproof lock

Press and hold the  button until the symbol goes out. You can make settings again.

Basic settings

Your appliance has various basic settings, which are preset at the factory. You can, however, change these basic settings as required.

If you want to cancel all the changes, you can restore the factory settings.

1. If required, turn the operating mode selector to  to switch off the appliance.
2. Press and hold the  button until  3 (display brightness = bright) appears in the display.
3. Press the  button until the desired basic setting appears.
4. Press the  or  button to change the basic setting.
5. Press and hold the  button to exit basic settings.
The change is saved.

You can change the following basic settings:

Basic setting	Function	Possible settings
c0 3	Display brightness	c0 1 = dark c0 2 = medium c0 3 = bright
c1 2	Signal duration: Sets the length of the audible signal at the end of an operation	c1 1 = short (10 seconds) c1 2 = medium (2 minutes) c1 3 = long (5 minutes)
c2 1	Displays the clock when the appliance is off	c2 0 = off c2 1 = on
c3 1	Continues after the door is closed. The operation does not go back to the beginning when the appliance door is opened	c3 0 = off c3 1 = on
c4 2	Time until changes are automatically saved	c4 1 = short (2 seconds) c4 2 = medium (5 seconds) c4 3 = long (10 seconds)
c5 2	Sets the water hardness range for the descaling indicator	c5 0 = softened c5 1 = soft (I) c5 2 = medium (II) c5 3 = hard (III) c5 4 = very hard (IV)
c6 0	Steam cooking heat signal:	c6 0 = off c6 1 = on
c7 0	Restores the appliance to the factory settings: ■ all changes to the basic settings are cleared ■ Automatic calibration is carried out again	c7 0 = do not restore c7 1 = restore

Automatic safety cut-out

If you do not change the settings on your appliance for several hours, the automatic safety switch-off function will be activated. **FB** appears in the display.

Press any button to deactivate the automatic safety switch-off. You can now make new settings.

Care and cleaning

In this section, you will find information on

- care and cleaning of your appliance
- the cleaning aid
- descaling

Risk of short circuit!

Do not use high-pressure cleaners or steam jet cleaners to clean your appliance.

Caution!

Risk of surface damage: Do not use

- harsh or abrasive cleaning agents
- oven cleaners
- corrosive or aggressive cleaners, or those containing chlorine
- cleaning agents with a high alcohol content

If such an agent comes into contact with the front of the appliance, wash it off immediately with water.

Caution!

Risk of surface damage: If descaler or the oven and grill cleaning gel comes into contact with the front of the appliance or other sensitive surfaces, wash it off immediately with water.

Remove food residues from the cooking compartment as soon as the appliance has cooled. Burnt-on remains will be much harder to remove later.

For heavy soiling use the cleaning aid (see section: Cleaning aid).

Salts are very corrosive and can cause rust. Remove remains of acidic sauces (ketchup, mustard) or salted food from the cooking compartment immediately after cooling.

Do not use hard scouring pads or cleaning sponges.

cleaning agents

Appliance exterior (with aluminium front)	Use soapy water and dry with a soft cloth. Mild window cleaning agent - wipe over the aluminium front horizontally and without applying pressure using a soft window cloth or a lint-free microfibre cloth.
Appliance exterior (with stainless steel front)	Use soapy water and dry with a soft cloth. Always remove flecks of limescale, grease, starch and albumin (e.g. egg white) immediately. Special stainless steel cleaning agents can be obtained from the after-sales service or from specialist retailers.
Cooking compartment interior with evaporator dish	Hot, soapy water or a vinegar solution - use the enclosed cleaning sponge or a soft washing-up brush. Caution! The cooking compartment could rust.: Do not use steel pads or scourers.
Water tank	Soapy water - do not clean in the dishwasher.
Tank recess	Rub dry after every use
Seal in the water tank lid	Thoroughly dry after every use
Rails	See section: Cleaning the rails
Door panels	See section: Cleaning the door panels Caution! Risk of surface damage: After cleaning, wipe the door panels with glass cleaner, then dry. Otherwise, stains will be caused that will not be able to be removed.
Door seal	Hot soapy water
Accessories	Soak in hot soapy water. Clean with a brush or washing-up sponge or in the dishwasher. If the rails are discoloured by starchy foods (e.g. rice), clean them with a vinegar solution.

Cleaning sponge

The enclosed cleaning sponge is very absorbent. Use the cleaning sponge only for cleaning the cooking compartment and for removing residual water from the evaporator dish.

Wash the cleaning sponge thoroughly before using for the first time. You can wash the cleaning sponge in the washing machine (hot wash).

Microfibre cloth

The honeycomb microfibre cloth is particularly suitable for cleaning sensitive surfaces such as glass, glass ceramic, stainless steel or aluminium (product no. 460 770, also available from our online eShop). It removes liquid and greasy deposits in one go.

Cleaning aid

The cleaning aid loosens dirt in the cooking compartment using steam. It can then be removed easily.

The cleaning process consists of:

- Cleaning (approx. 30 minutes), then empty the evaporator dish and wipe out the appliance
- 1st rinse (20 seconds), then empty the evaporator dish
- 2nd rinse (20 seconds), then remove the remaining water

All three steps must be completed in full. The appliance is ready for operation again only after the 2nd rinse.

Preparation

Allow the cooking compartment to cool down and remove the accessories. Clean the evaporator dish with the enclosed cleaning sponge.

Put a drop of washing-up liquid into the evaporator dish on the cooking compartment floor.



Starting the cleaning aid

1. Turn the operating mode selector to  Cleaning aid.
2. Fill the water tank with water up to the "max" mark and slide it in.

3. Press the  button.

The cleaning aid starts running. The light in the cooking compartment remains switched off.

Emptying the evaporator dish and wiping out the appliance



An audible signal sounds after approx. 30 minutes. The  (Empty evaporator dish) and  00:40 min symbols appear.

1. Open the appliance door.
2. Take the rails out of the cooking compartment and clean them (see section: Cleaning the rails).
3. Wipe out all loosened food residues from the cooking compartment and the evaporator dish using a soft washing-up brush and the cleaning sponge.
4. If required, fill the water tank with water and reinsert it.
5. Close the appliance door.

1st rinse

Press the  button.
The appliance starts rinsing.

Empty evaporator dish



After 20 seconds,  (Empty evaporator dish) and  0:20 appear.

1. Open the appliance door.
2. Thoroughly rinse out the cleaning sponge.
3. Remove the remaining water from the evaporator dish using the cleaning sponge.
4. Close the appliance door.

2nd rinse

Press the  button.
The appliance starts rinsing.

Removing the remaining water

After 20 seconds,  (Empty evaporator dish) and  00:00 appear in the display.

1. Open the appliance door.

2. Remove the remaining water from the evaporator dish using the cleaning sponge.
3. Wipe out the cooking compartment using the cleaning sponge and then dry with a soft cloth.
4. To switch off the appliance, turn the operating mode selector back to 0.

The cleaning aid has finished.

Cancelling the cleaning aid

Note: After cancelling the cleaning aid, the appliance must be rinsed twice. The appliance is locked for other applications until the second rinsing operation is complete.

1. Press and hold the ▷ button in order to cancel the cleaning aid.
[-] 00:40 min appears in the display.
To ensure that no washing-up liquid remains in the appliance, it must be rinsed twice after a cancellation.

2. Press the ▷ button.
The symbol (Empty evaporator dish) appears.

Now proceed as described in the section "Emptying the evaporator dish and wiping out the appliance".

Descaling

The appliance must be descaled at regular intervals in order for it to continue operating correctly. The indicator reminds you to do this.

You can only dispense with descaling completely if you exclusively use softened water.

The descaling operation consists of:

- Descal (approx. 30 minutes), then refill the water tank and empty the evaporator dish
- 1st rinse (20 seconds), then empty the evaporator dish
- 2nd rinse (20 seconds), then remove the remaining water

All three steps must be completed in full. The appliance is ready for operation again only after the 2nd rinse.

Descaler

Only use the liquid descaler recommended by the after-sales service for descaling (product no. 311 138, also available online from the eShop). Other descalers may damage the appliance.

1. Prepare a descaling solution by mixing 300 ml water and 60 ml liquid descaler.
2. Empty the water tank and fill with descaling solution.

Caution!

Risk of surface damage: If descaler comes into contact with the front of the appliance or any other sensitive surfaces, wash it off immediately with water.

Starting descaling

The cooking compartment must have cooled down completely.

1. Turn the operating mode selector to Descale.
2. Slide in the water tank containing the descaling solution and close the appliance door.
3. Press the ▷ button.
The descaling process starts. The light in the cooking compartment remains switched off.

Emptying the evaporator dish and refilling the water tank

An audible signal sounds after approx. 30 minutes. The symbol (Fill water tank) and [-] 00:40 min are displayed.

1. Open the appliance door.
2. Rinse the water tank thoroughly, fill with water and reinsert.

The symbol (Empty evaporator dish) appears.

3. Remove the descaling solution from the evaporator dish using the cleaning sponge supplied.
4. Close the appliance door.

1st rinse

Press the ▷ button.
The appliance starts rinsing.

Empty evaporator dish

After 20 seconds, symbol (Empty evaporator dish) and [-] 0:20 appear.

1. Open the appliance door.
2. Thoroughly rinse out the cleaning sponge.
3. Remove the remaining water from the evaporator dish using the cleaning sponge.
4. Close the appliance door.

2nd rinse

Press the ▷ button.
The appliance starts rinsing.

Removing the remaining water

After 20 seconds, symbol (Empty evaporator dish) and 00:00 appear.

1. Open the appliance door.
2. Remove the remaining water from the evaporator dish using the cleaning sponge.
3. Wipe out the cooking compartment using the cleaning sponge and then dry with a soft cloth.
4. To switch off the appliance, turn the operating mode selector back to 0.
Descaling is complete.

Cancelling the descaling

Note: After cancelling, the appliance must be rinsed twice. The appliance is locked for other applications until the second rinsing operation is complete.

1. Press and hold the ▷ button to cancel the descaling process.
[-] 00:40 min appears in the display.
To ensure that no descaling solution remains in the appliance, it must be rinsed twice after a cancellation.

2. Press the ▷ button.
The symbol (Fill water tank) appears.

Now proceed as described in the "Emptying the evaporator dish and refilling the water tank" section.

Descaling the evaporator dish only

You can also use the Descale operating mode if you do not wish to descale the whole appliance, but only the evaporator dish in the cooking compartment.

The only difference is as follows:

1. Prepare a descaling solution by mixing 100 ml water and 20 ml liquid descaler.
2. Completely fill the evaporator dish with descaling solution.
3. Fill the water tank with water only.
4. Start the Descale operating mode as described.

You can also descale the evaporator dish manually.

Removing and fitting the appliance door

You can remove the appliance door to clean it more thoroughly.

⚠ Risk of injury!

The hinges of the appliance door may snap shut with great force. Always open the hinge locking lever fully when removing the appliance door and close it fully after refitting. Do not reach into the hinge.

⚠ Risk of injury!

If the appliance door has only been unhinged on one side, do not reach into the hinge. The hinge can snap back with great force. Call the after-sales service.

Removing the appliance door

1. Open the appliance door fully.
2. Fold out the locking levers on the left and right fully (figure A). The hinges are secured and cannot snap closed.
3. Close the appliance door until you feel some resistance.
4. With both hands, grip the door on the left and right-hand side, close the door a little more and pull it out (Fig. B).

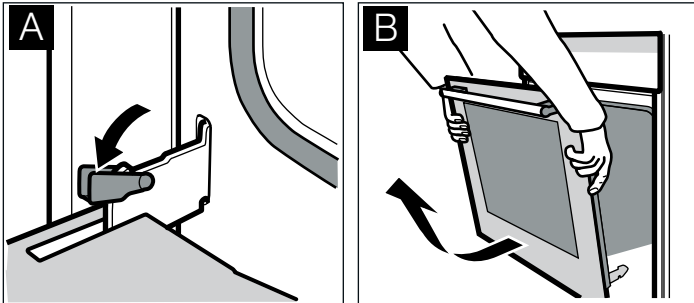

Fitting the appliance door

Refit the appliance door after cleaning.

1. Insert the hinges in the left and right-hand bracket (figure C). The notch on both hinges must engage.
2. Open the appliance door fully.
3. Close the locking levers on the left and right-hand side fully (figure D).

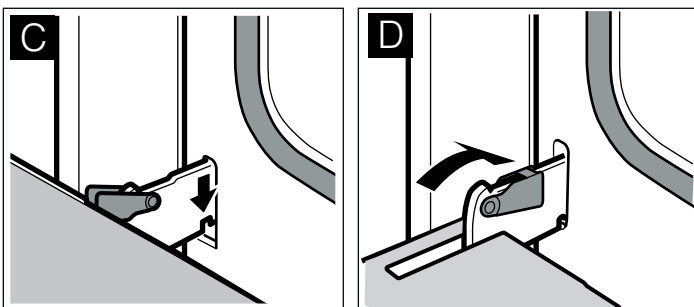

The appliance door is secured and can no longer be removed.

4. Close the appliance door.

Cleaning the door panels

To facilitate cleaning, you can remove the door panels from the appliance door.

⚠ Risk of injury!

The components inside the appliance door may have sharp edges. Take care not to cut yourself. Wear protective gloves.

⚠ Risk of injury!

The appliance must not be used again until the door panels and appliance door have been correctly fitted.

Removing the door panel

Note: Before removing, make a note of the orientation in which the door panel is fitted, so that it is not refitted the wrong way round.

1. Unhook the appliance door and lay it on a soft, clean surface with the front side facing downwards (see section: Removing and installing the appliance door).
2. Unscrew the cover at the top left and right of the appliance door and detach it (figure A).
3. Lift the door panel and remove it (figure B).

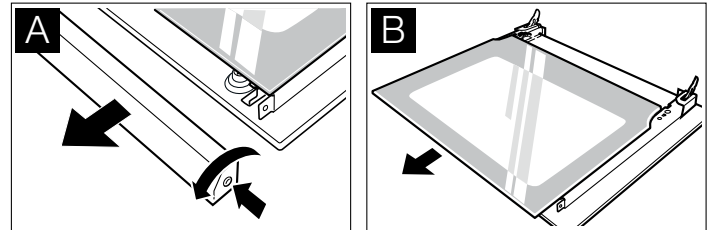

Removing the intermediate panel

Before removing, make a note of the position in which the intermediate panel is fitted, so that you do not refit it the wrong way round later.

1. Press the left and right-hand holders outwards.
2. Lift the intermediate panel slightly and take it out.

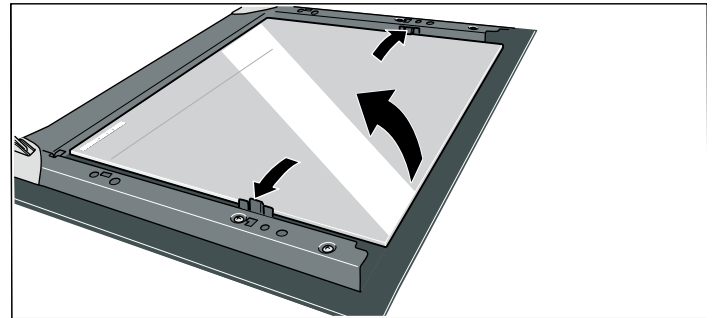

Cleaning

Clean the door panels with glass cleaner and a soft cloth.

Caution!

Do not use any sharp or abrasive medium or a glass scraper. The glass could be damaged.

Fitting the intermediate panel

1. Insert the intermediate panel on the left and right into the supports.
2. Push the intermediate panel downwards in the retainers.

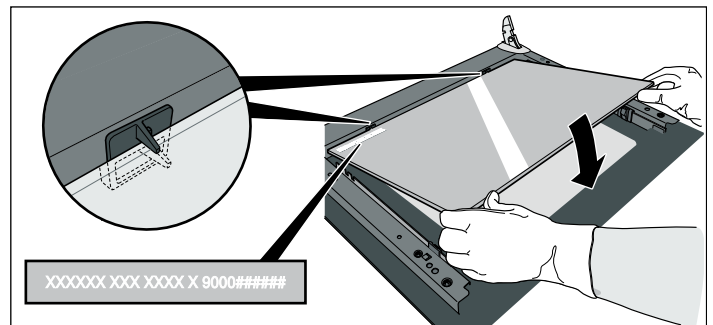

Fitting the door panel

1. Slide in the door panel all the way.
2. Put the cover back in place and screw it in.
3. Refit the appliance door.

Cleaning the rails

The rails can be removed for cleaning.

⚠ Risk of burning due to hot components in the cooking compartment!

Wait until the cooking compartment has cooled down.

Detaching the rails

Note: Swing the front of the rail as far as possible (until you feel resistance), because otherwise the appliance side panel may become bent.

1. Carefully press the front of the rail upwards until it becomes detached, and release it from the holder at the side (fig. A).
2. Detach the rail from the holder and remove it (fig. B).

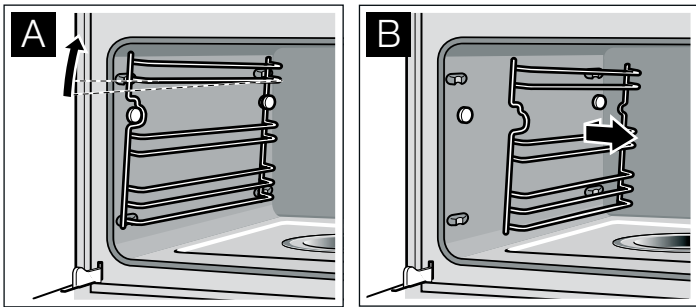

3. Clean the rails with washing-up liquid and a sponge/brush or
Clean the rails in the dishwasher.

Attaching the rail

1. Position the rail so that the indentations are facing upwards.
2. Hook the rail in at the back and push it towards the rear until it engages (fig. C).
3. Hook the front of the rail onto the holder and press down until it engages and is fixed level in place in the appliance once more (fig. D).

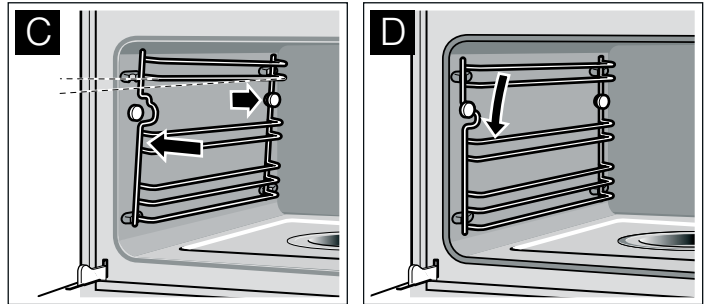

Each set of rails only fits on one side.

Troubleshooting

Malfunctions often have simple explanations. Please read the following instructions before calling the after-sales service.

Repairs may only be carried out by fully trained after-sales service technicians. Incorrect repairs to your appliance may present considerable risks for the user.

⚠ Risk of electric shock!

- Work on the appliance electronics may only be performed by a specialist.
- Always disconnect the appliance from the power supply when work is carried out on the electronics. Switch off the circuit breaker or remove the fuse from your household fuse box.

Problem	Possible cause	Notes/remedy
The appliance does not work	The plug is not plugged in.	Connect the appliance to the electricity supply
	Power cut	Check whether other kitchen appliances are working
	Fuse defective	Check in the fuse box to make sure that the fuse for the appliance is OK
	Faulty operation	Switch off the fuse for the appliance in the fuse box. Wait approximately 10 seconds and then switch it back on
Appliance does not start. [🔊] 00:40 min appears in the display.	Cleaning aid or descaling was cancelled	Turn the operating mode selector to [🔊] or [🔊] and rinse the appliance twice (see section "Cancelling the cleaning aid" or "Cancelling descaling")
The appliance cannot be started	The appliance door is not fully closed	Close the appliance door.
The appliance is not in operation. A duration is shown in the display	A control knob was unintentionally pressed	Press and hold the [🔊] button
	The [🔊] button was not pressed after making the setting	Press the [🔊] button briefly to start the cooking operation, or press and hold the [🔊] button to cancel the setting
Appliance does not start. An audible signal sounds	A temperature outside of the possible temperature range has been set	Check the temperature ranges for the operating modes
Turning the temperature selector cancels the cooking operation	A temperature outside of the possible temperature range has been set	Check the temperature ranges for the operating modes. Press the [🔊] button

Problem	Possible cause	Notes/remedy
☹ and 00:00 light up in the display	Power cut	Reset the clock time (see section: "Time-setting options")
FB is shown in the display	The automatic safety switch-off is active	Press any button.
The  indicator appears even though the water tank is full	The water tank has not been inserted properly	Slide in the water tank until it locks into place.
	The detection system is not working	Call the after-sales service
The  indicator appears even though the water tank is not yet empty, or the water tank is empty but the  indicator does not appear	The water tank is dirty. The mobile water level indicators are jammed	Shake and clean the water tank. If the parts cannot be released, obtain a new water tank from the after-sales service.
The water tank empties for no discernible reason. The evaporator dish is overflowing	The water tank was not closed properly	Close the lid until you feel it engage.
	The tank lid seal is dirty	Clean the seal
	The seal in the tank cover is defective	Obtain a new water tank from the after-sales service
The evaporator dish has boiled empty even though the water tank is full.	The water tank has not been inserted properly	Slide in the water tank until it locks into place
	The feed line is blocked	Descal the appliance. Check whether the water hardness range is set correctly
The  indicator appears	The appliance has not been used for at least 2 days and the water tank is full	Empty and clean the water tank. Always empty the water tank after cooking
There is a "pop" noise during cooking	Cold/warm effect with frozen food, caused by the steam	This is normal
When you cook with steam, a lot of steam is created	The appliance is being automatically calibrated	This is normal
When cooking with steam, a lot of steam is created again	The appliance is unable to calibrate itself automatically if cooking times are too short	Reset the appliance to the factory settings (see Basic settings section). Then start Steam at 100 °C for 20 minutes
Steam escapes from the ventilation slots during cooking		This is normal
The appliance is not producing steam properly	Limescale has formed in the appliance	Start the descaling programme.
Error message E011 appears in the display	A button was pressed for too long or is jammed	Press the ☹ button to clear the fault message. Press all of the buttons individually and check if they are clean
An E... error message appears in the display	Technical fault	Press the ☹ button to delete the error message. Reset the clock if required. If the error message appears again, call the after-sales service
The appliance is not heating The colon flashes in the display	A button combination was actuated	Set the Steam operating mode to 35 °C, then press and hold the  button until an audible signal sounds. Press the  button again briefly

Replacing the cooking compartment bulb

Heat-resistant 230 V/25 W halogen bulbs with seals are available from the after-sales service. Please specify the E number and FD number of your appliance.

Risk of burns!

Allow the cooking compartment and cooking compartment light to cool before changing the bulb.

Always use a dry cloth to remove a new halogen bulb from the packaging, otherwise it will not last as long.

1. Switch off the fuse in the fuse box or unplug at the mains.
2. Turn the cover anti-clockwise to remove.
3. Remove the bulb and replace with a bulb of the same type.
4. Slide the new seals and the clamping ring onto the glass cover in the right order.

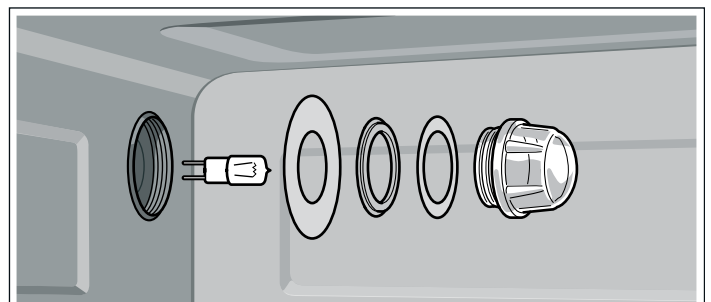

5. Screw the glass cover with the seals back on again.
6. Connect the appliance to the mains and reset the clock. Never operate the appliance without the glass cover and seals.

Replacing the glass cover or seals

Any damaged glass cover or seals must be replaced. Please provide the after-sales service with the E number and FD number of your appliance.

Changing the door seal

If the seal around the outside of the cooking compartment is faulty, it must be replaced. Replacement seals for your appliance can be obtained from the after-sales service. Please specify the E number and FD number of your appliance.

1. Open the appliance door.
2. Pull off the old seal.
3. Push in the new door seal at one point and pull it in all the way round. The joint must be at the side.
4. Check again that the seal is correctly fitted in the corners.

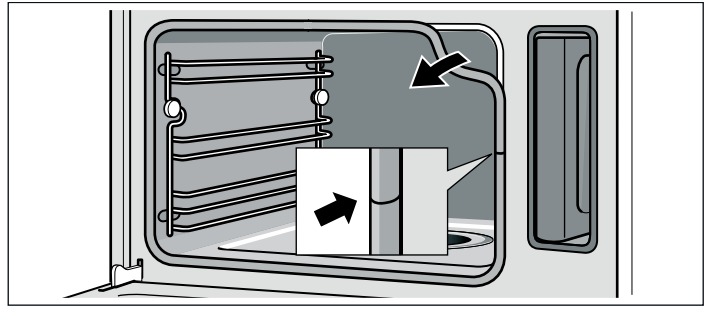

After-sales service

Our after-sales service is there for you if your appliance needs to be repaired. We will always find the right solution in order to avoid unnecessary visits from a service technician.

E number and FD number

When calling us, please give the product number (E no.) and the production number (FD no.) so that we can provide you with the correct advice. The rating plate bearing these numbers can be found on the lower left-hand side when you open the appliance door.

You can make a note of the numbers of your appliance and the telephone number of the after-sales service in the space below to save time should it be required.

E no.	FD no.

After-sales service ☎

Please note that there will be a fee for a visit by a service technician in the event of a malfunction, even during the warranty period.

Please find the contact data of all countries in the enclosed customer service list.

To book an engineer visit and product advice

GB 0844 8928979

Calls from a BT landline will be charged at up to 3 pence per minute. A call set-up fee of up to 6 pence may apply.

IE 01450 2655

Trust the expertise of the manufacturer, and rest assured that the repair will be carried out by trained service technicians using original spare parts for your domestic appliance.

Environmental protection

Environmentally-friendly disposal

Dispose of packaging in an environmentally-friendly manner.



This appliance is labelled in accordance with European Directive 2012/19/EG concerning used electrical and electronic appliances (waste electrical and electronic equipment - WEEE). The guideline determines the framework for the return and recycling of used appliances as applicable throughout the EU

Tips for saving energy

- Only preheat the appliance if this is specified in the recipe or in the operating instructions table.
- Open the appliance door as infrequently as possible while the food is cooking.
- Use dark, black lacquered or enamelled baking tins for baking. They absorb the heat particularly well.
- It is best to bake several cakes one after the other. The combination steam oven will still be hot. This reduces the baking time for the second cake. You can also place two loaf tins next to each other.
- If the cooking time is relatively long, you can switch off the combination steam oven 10 minutes before the end of the cooking time and use the oven's residual heat to complete the cooking process.
- When steaming, you can cook on several levels at the same time. When preparing foods with different cooking times, those with the longest cooking time should be placed in the oven first.

Tables and tips

The tables contain a selection of dishes which are particularly suitable for your combination steam oven. You can find out which operating mode, accessories and cooking time to select. Unless otherwise stated, the information given applies to inserting accessories when the appliance is cold.

Accessories

Use the accessories provided.

When steaming in the perforated cooking container, always insert the baking tray underneath. Dripping liquid is caught.

Ovenware

When using ovenware, always place it in the middle of the wire rack.

Ovenware must be heat and steam resistant. Cooking times are increased if thick-sided ovenware is used.

Food which would normally be prepared in a bain-marie should always be covered with foil (e.g. when melting chocolate).

Steam

Steaming is a particularly gentle way of cooking food. The steam surrounds the dish thereby preventing a loss of nutrients from the food. Cooking takes place without excess pressure.

As a result, the shape, colour and typical aroma of the dishes are retained.

Cooking times and quantities

The cooking times when steaming depend on the item size, but do not depend on the total quantity. The appliance can steam food to a maximum of 2 kg.

Follow the unit sizes given in the tables. The cooking time is reduced for smaller pieces and increased for larger ones.

Cooking time is also influenced by the quality and ripeness of the food. The values quoted can therefore only serve as a guideline.

Vegetables

Place the vegetables in the perforated cooking container and insert at level 3. Insert the baking tray underneath at level 1. Dripping liquid is caught.

Food	Size	Accessories	Operating mode	Temperature in °C	Cooking time in min.
Artichokes	whole	perforated + baking tray	Steam	100	30 - 35
Cauliflower	whole	perforated + baking tray	Steam	100	30 - 40
Cauliflower	Florets	perforated + baking tray	Steam	100	10 - 15
Broccoli	Florets	perforated + baking tray	Steam	100	8 - 10
Peas	-	perforated + baking tray	Steam	100	5 - 10
Fennel	Slices	perforated + baking tray	Steam	100	10 - 14
Stuffed vegetables (courgettes, aubergines, peppers)	Do not pre-cook vegetables	baking tray at level 2	Combination	160 - 180	15 - 30
Vegetable flan	-	1.5 l bain-marie dish + wire rack at level 2	Steam	100	50 - 70
Green beans	-	perforated + baking tray	Steam	100	15 - 20
Carrots	Slices	perforated + baking tray	Steam	100	10 - 20
Kohlrabi	Slices	perforated + baking tray	Steam	100	15 - 20

* Preheat the appliance

Distributing food evenly

Always distribute the food evenly in the ovenware. It will not cook evenly if the layers are of different depths.

Pressure-sensitive food

When layering delicate foods in the cooking container, do not pile them too high. It is better to use two containers.

Cooking a menu

With steam, you can cook a whole menu at once, without the different flavours mixing. Place the food with the longest cooking time in the appliance first and delay the rest until the appropriate time. This means that all the food will be ready at the same time.

The overall cooking time is extended with menu cooking, as a little steam escapes each time the appliance door is opened and has to be reheated.

Hot air

The Hot Air operating mode is ideal for sweet and savoury baking, pot roasts and various cakes.

Combination

Because combination cooking combines the use of hot air and steam, it is particularly suitable for preparing roasted joints, chicken and baked goods such as yeast-risen pastry and bread.

Roasts and chicken are nice and crisp on the outside and juicy inside. What is more, meat loses less of its weight.

Baked items, such as yeast-risen pastry and bread, take on a particularly attractive surface shine and they do not dry out.

Food	Size	Accessories	Operating mode	Temperature in °C	Cooking time in min.
Leeks	Slices	perforated + baking tray	Steam	100	4 - 6
Sweetcorn	whole	perforated + baking tray	Steam	100	25 - 35
Swiss chard*	Shredded	perforated + baking tray	Steam	100	8 - 10
Green asparagus*	whole	perforated + baking tray	Steam	100	7 - 12
White asparagus*	whole	perforated + baking tray	Steam	100	10 - 15
Spinach*	-	perforated + baking tray	Steam	100	2 - 3
Romanesco	Florets	perforated + baking tray	Steam	100	8 - 10
Brussels sprouts	Florets	perforated + baking tray	Steam	100	20 - 30
Beetroot	Whole	perforated + baking tray	Steam	100	40 - 50
Red cabbage	shredded	perforated + baking tray	Steam	100	30 - 35
White cabbage	shredded	perforated + baking tray	Steam	100	25 - 35
Courgettes	Slices	perforated + baking tray	Steam	100	2 - 3
Mangetout	-	perforated + baking tray	Steam	100	8 - 12

* Preheat the appliance

Side dishes and pulses

Add water or liquid in the proportion specified. Example: 1:1.5 = for every 100 g of rice add 150 ml of liquid.

You may select any shelf position you wish for the solid cooking container.

Food	Ratio	Accessories	Level	Operating mode	Temperature in °C	Cooking time in min.
Unpeeled boiled potatoes (medium size)	-	perforated + baking tray	3 1	Steam	100	35 - 45
Boiled potatoes (quartered)	-	perforated + baking tray	3 1	Steam	100	20 - 25
Potato gratin	-	baking tray	2	Hot air	170 - 180	35 - 45
Brown rice	1:1.5	solid	-	Steam	100	30 - 40
Long grain rice	1:1.5	solid	-	Steam	100	20 - 30
Basmati rice	1:1.5	solid	-	Steam	100	20 - 30
Parboiled rice	1:1.5	solid	-	Steam	100	15 - 20
Risotto	1:2	solid	-	Steam	100	30 - 35
Lentils	1:2	solid	-	Steam	100	30 - 45
Canellini beans, pre-softened	1:2	solid	-	Steam	100	65 - 75
Couscous	1:1	solid	-	Steam	100	6 - 10
Unripe spelt grain, coarse ground	1:2.5	solid	-	Steam	100	15 - 20
Millet, whole	1:2.5	solid	-	Steam	100	25 - 35
Wheat, whole	1:1	solid	-	Steam	100	60 - 70
Dumplings	-	perforated + baking tray	3 1	Steam	80 - 90	20 - 30

Poultry and meat

Insert the wire rack and baking tray together at the same level.

When the roast is cooked, switch off the combination steam oven and leave the roast to rest for a further 10 minutes with the door closed. This will keep the meat juicier.

Cooking with the Combination mode leaves the meat particularly juicy on the inside and crispy on the outside.

Poultry

Food	Amount	Accessories	Level	Operating mode	Temperature in °C	Cooking time in min.
Chicken, whole	1.2 kg	wire rack + baking tray	2	Combination	180 - 190	50 - 60
Chicken, halved	0.4 kg each	wire rack + baking tray	2	Combination	180 - 190	35 - 45
Chicken breast	0.15 kg each	perforated + baking tray	3 1	Steam	100	15 - 25
Chicken portions	0.12 kg each	wire rack + baking tray	2	Combination	180 - 200	20 - 35
Duck, whole	2 kg	wire rack + baking tray	2	Combination	170	60 - 80
				Hot air	210	15 - 20
Duck breast*	0.35 kg each	wire rack + baking tray	2	Combination	170 - 180	10 - 15
Rolled turkey joint	1.5 kg	wire rack + baking tray	2	Combination	150 - 160	70 - 90
Turkey breast	1 kg	wire rack + baking tray	2	Combination	150 - 160	60 - 80

* Sear first

Beef

Food	Amount	Accessories	Level	Operating mode	Temperature in °C	Cooking time in min.
Pot-roasted beef*	1.5 kg	wire rack + baking tray	2	Reheat	140 - 150	100 - 140
Fillet of beef, medium*	1 kg	wire rack + baking tray	2	Reheat	170 - 180	20 - 28
Thin slice of sirloin, medium*	1 kg	wire rack + baking tray	2	Hot air	170 - 180	40 - 55
Thin slice of sirloin, rare*	1 kg	wire rack + baking tray	2	Hot air	170 - 180	30 - 45
Thick piece of sirloin, medium*	1 kg	wire rack + baking tray	2	Hot air	170 - 180	45 - 60
Thick piece of sirloin, rare*	1 kg	wire rack + baking tray	2	Hot air	170 - 180	35 - 50

* Sear first

Veal

Food	Amount	Accessories	Level	Operating mode	Temperature in °C	Cooking time in min.
Joint of veal, marbled	1 kg	wire rack + baking tray	2	Combination	160 - 170	60 - 70
Joint of veal, lean	1 kg	wire rack + baking tray	2	Combination	160 - 170	50 - 60
Veal back*	1 kg	wire rack + baking tray	2	Combination	160 - 180	15 - 25
Breast of veal, stuffed	1.5 kg	wire rack + baking tray	2	Combination	140 - 160	75 - 120

* Sear first

Pork

Food	Amount	Accessories	Level	Operating mode	Temperature in °C	Cooking time in min.
Joint without rind (e.g. neck)	1.5 kg	wire rack + baking tray	2	Combination	170 - 180	70 - 80
Joint with rind (crackling)	1.5 kg	wire rack + baking tray	2	Steam	100	20 - 25
				Combination	140 - 160	40 - 50
				Hot air	210 - 220	20
Pork fillet*	0.5 kg	wire rack + baking tray	2	Combination	160 - 180	20 - 30
Fillet in puff pastry	1 kg	baking tray	2	Combination	180 - 200	40 - 60

* Sear first

Food	Amount	Accessories	Level	Operating mode	Temperature in °C	Cooking time in min.
Smoked pork on the bone	1 kg	wire rack + baking tray	2	Combination	120 - 140	60 - 70
Smoked pork ribs	sliced	baking tray	2	Steam	100	15 - 20
Rolled joint	1.5 kg	wire rack + baking tray	2	Combination	170 - 180	70 - 80

* Sear first

Miscellaneous

Food	Amount	Accessories	Level	Operating mode	Temperature in °C	Cooking time in min.
Meat loaf	made from 0.5 kg minced meat	baking tray	2	Combination	140 - 150	45 - 60
Saddle of venison on the bone*	0.6 - 0.8 kg	wire rack + baking tray	2	Combination	150 - 170	15 - 30
Boned leg of lamb	1.5 kg	wire rack + baking tray	2	Combination	170 - 180	60 - 80
Saddle of lamb on the bone*	1.5 kg	wire rack + baking tray	2	Combination	160 - 170	15 - 25
Rabbit portions	1.5 kg	wire rack + baking tray	2	Combination	150 - 160	40 - 60
Wiener sausages	-	perforated + baking tray	3 1	Steam	80 - 85	12 - 18
Bavarian veal sausages	-	perforated + baking tray	3 1	Steam	80 - 85	15 - 20

* Sear first

Roasting tips

Using the roasting set	Using the roasting set will give optimum results and the cooking compartment will stay as clean as possible. You can purchase the roasting set as an accessory from specialist retailers (see section: Accessories)
When is the roast ready?	Use a meat thermometer (available from specialist retailers) or carry out the "spoon test": press down on the roast with a spoon. If it feels firm, it is ready. If the spoon can be pressed in, it needs to be cooked for a little longer.
The roast is too dark and the outside is burnt in places.	Check the shelf height and temperature.
The roast looks good but the juices are burnt.	Next time, choose a smaller roasting dish or add more liquid.
The roast looks good, but the juices are too clear and watery.	Next time, choose a larger roasting dish or add less liquid.

Fish

Food	Amount	Accessories	Level	Operating mode	Temperature in °C	Cooking time in min.
Sea bream, whole	per 0.3 kg	perforated + baking tray	3 1	Steam	80 - 90	15 - 25
Sea bream fillet	per 0.15 kg	perforated + baking tray	3 1	Steam	80 - 90	10 - 20
Fish terrine	Bain marie 1.5 l	wire rack	2	Steam	70 - 80	40 - 80
Trout, whole	per 0.2 kg	perforated + baking tray	3 1	Steam	80 - 90	12 - 15
Cod fillet	per 0.15 kg	perforated + baking tray	3 1	Steam	80 - 90	10 - 14
Salmon fillet	per 0.15 kg	perforated + baking tray	3 1	Steam	100	8 - 10
Mussels	1.5 kg	baking tray	2	Steam	100	10 - 15
Ocean perch fillet	per 0.15 kg	perforated + baking tray	3 1	Steam	80 - 90	10 - 20
Sole rolls, stuffed	-	perforated + baking tray	3 1	Steam	80 - 90	10 - 20

Bakes, additional soup ingredients, etc.

Food	Accessories	Level	Operating mode	Temperature in °C	Cooking time in min.
Savoury bake made from cooked ingredients	ovenproof dish + wire rack	2	Combination	150 - 170	30 - 40
Sweet bake	ovenproof dish + wire rack	2	Combination	150 - 170	30 - 45
Lasagne	baking tray	2	Combination	160 - 170	35 - 45
Soufflé	mould + wire rack	2	Combination	180 - 200	15 - 25
Royale	solid	2	Steam	90	15 - 20
Semolina dumplings	perforated + baking tray	3 1	Steam	80 - 90	7 - 12
Hard-boiled eggs (Size M, max. 1.8 kg)	perforated + baking tray	3 1	Steam	100	10 - 12
Soft-boiled eggs (Size M, max. 1 kg)	perforated + baking tray	3 1	Steam	100	6 - 8

Dessert, compote

Compote:

Weigh the fruit and add approximately $\frac{1}{3}$ the amount of water, and add sugar and spices according to taste.

Rice pudding

Weigh the rice and add 2.5 times the amount of milk. Ensure the level of rice and milk in the accessory is no higher than 2.5 cm. Stir after cooking. The remaining milk is quickly absorbed.

Yoghurt

Heat the milk to 90 °C on the hob. Then leave to cool to 40 °C. If you are using UHT milk, you do not need to heat it.

Stir in one to two teaspoons of natural yoghurt per 100 ml milk, or the corresponding amount of yoghurt culture into the milk. Pour the mixture into clean jars and seal them.

After preparation, leave the glasses to cool in the refrigerator.

Food	Accessories	Operating mode	Temperature in °C	Cooking time in min.
Yeast dumplings	baking tray	Steam	100	20 - 25
Crème caramel	mould + wire rack	Steam	85 - 90	25 - 30
Sweet bake (e.g. semolina pudding)	ovenproof dish + wire rack	Combination	160 - 170	50 - 60
Rice pudding*	baking tray	Steam	100	25 - 35
Yoghurt*	Portion-sized glasses + wire rack	Steam	40	300 - 360
Apple compote	baking tray	Steam	100	10 - 15
Pear compote	baking tray	Steam	100	10 - 15
Cherry compote	baking tray	Steam	100	10 - 15
Rhubarb compote	baking tray	Steam	100	10 - 15
Plum compote	baking tray	Steam	100	15 - 20

* You can also use the appropriate programmes (see section: Automatic programmes)

Cakes and pastries

It is best to use dark-coloured metal baking tins.

The temperature and cooking time depend on the quantity and composition of the dough. That is why ranges of temperatures are given in the tables.

First set the lower temperature. This will brown the dish more evenly. A higher temperature can be selected next time, if required.

Do not overpack the wire rack or baking tray with food.

Cakes in tins

Food	Accessories	Level	Operating mode	Temperature in °C	Cooking time in min.
Sponge cake	Ring/loaf tin	2	Hot air	150 - 160	60 - 70
Sponge flan base	Flan tin	2	Hot air	150 - 160	30 - 45
Delicate fruit flan, sponge	Springform cake tin	2	Hot air	150 - 160	45 - 55
Sponge base (2 eggs)	Flan tin	2	Hot air	180 - 190	12 - 16
Sponge cake (6 eggs)	Springform cake tin	2	Hot air	150 - 160	25 - 35
Shortcrust pastry base with crust	Springform cake tin	2	Hot air	150 - 160	40 - 50
Swiss flan	Springform cake tin	2	Hot air	180 - 190	35 - 60
Ring cake	Ring cake tin	2	Combination	150 - 160	35 - 45

Food	Accessories	Level	Operating mode	Temperature in °C	Cooking time in min.
Savoury cakes (e.g. quiche)	Quiche dish	2	Hot air	180 - 190	35 - 60
Apple tart	Flan-base cake tin	2	Hot air	170 - 190	35 - 50

Cakes on trays

Food	Accessories	Level	Operating mode	Temperature in °C	Cooking time in min.
Yeast cake with dry topping	baking tray	2	Combination	150 - 160	35 - 45
Yeast cake with moist topping (fruit)	baking tray	2	Hot air	150 - 160	35 - 45
Swiss roll	baking tray	2	Hot air	180 - 200	10 - 15
Plaited loaf (500 g flour)	baking tray + greaseproof paper	2	Combination	150 - 160	25 - 35
Strudel, sweet	baking tray	2	Combination	160 - 180	40 - 60
Onion cake	baking tray	2	Combination	170 - 180	30 - 40

Bread, bread rolls

Food	Accessories	Level	Operating mode	Temperature in °C	Cooking time in min.
White bread (750 g flour)	baking tray + greaseproof paper	2	Combination	200 - 210	15 - 20
			Hot air	160 - 170	20 - 25
Sourdough bread (750 g flour)	baking tray + greaseproof paper	2	Combination	200 - 220	15 - 25
			Hot air	150 - 160	40 - 60
Multigrain bread (750 g flour)	baking tray + greaseproof paper	2	Combination	200 - 220	15 - 20
			Hot air	160 - 170	25 - 40
Wholemeal bread (750 g flour)	baking tray + greaseproof paper	2	Combination	200 - 220	20 - 30
			Hot air	140 - 150	40 - 60
Rye bread (750 g flour)	baking tray + greaseproof paper	2	Combination	200 - 220	20 - 30
			Hot air	150 - 160	50 - 60
Bread rolls (70 g each, unbaked)	baking tray + greaseproof paper	2	Combination	190 - 200	25 - 30
Bread rolls made with sweet yeast dough (70 g each, unbaked)	baking tray + greaseproof paper	2	Combination	170 - 180	20 - 30

Small baked items

Food	Accessories	Level	Operating mode	Temperature in °C	Cooking time in min.
Meringue	baking tray	2	Hot air	80 - 90	120 - 180
Macaroons	baking tray	2	Hot air	140 - 160	15 - 25
Puff pastry	baking tray	2	Combination	170 - 190	10 - 20
Muffins	bun tray	2	Hot air	170 - 180	20 - 30
Choux pastry	baking tray	2	Hot air	170 - 190	27 - 35
Biscuits	baking tray	2	Hot air	150 - 160	12 - 17
Leavened cake	baking tray	2	Hot air	150 - 160	15 - 20

Baking tips

You want to bake according to your own recipe	Use similar items in the baking tables as a guide
How to tell whether sponge cake is baked through	Approx. 10 minutes before the end of the baking time stated in the recipe, insert a cocktail stick into the cake at its deepest point. If the cocktail stick comes out clean, the cake is ready.
The cake collapses	Next time, use less liquid or set the baking temperature 10 °C lower. Note the stirring times indicated in the recipe.
The cake has risen in the middle but is lower around the edge	Do not grease the edge of the springform cake tin. After baking, carefully loosen the cake using a knife
Cakes baked in a tray or tin are over-browned at the back	Place the baking tray in the middle of the accessories, not directly against the back wall

The cake is too dry	Make tiny holes in the finished cake using a cocktail stick. Then drizzle fruit juice or an alcoholic drink over it. Next time, set the temperature 10 °C higher and shorten the baking times or use the Combination operating mode
The bread or cake looks good but it is soggy inside (overmoist with watery streaks)	Next time, use less liquid. Bake at a lower temperature for a little longer. For cakes with a moist topping, bake the base first. Cover the base with almonds or bread crumbs first and then apply the topping. Observe the baking time in the recipe
The cake or pastry is unevenly browned	Next time, set the temperature a little lower

Reheating food

Using Reheat, dishes can be gently reheated. They taste and look like they have been freshly prepared. Even baked items from the day before can be recrisped.

Food	Accessories	Level	Operating mode	Temperature in °C	Cooking time in min.
Meals on plates	wire rack	2	Reheat	120	12 - 18
Vegetables	baking tray	3	Reheat	100	12 - 15
Pasta, potatoes, rice	baking tray	3	Reheat	100	5 - 10
Bread rolls*	wire rack	2	Combination	170 - 180	6 - 8
Baguette*	wire rack	2	Combination	170 - 180	5 - 10
Bread*	wire rack	2	Combination	170 - 180	8 - 12
Pizza	wire rack + baking tray	3	Reheat	170 - 180	12 - 15

* Preheat for 5 minutes

Defrosting

When freezing, lay the food as flat as possible and in portion-sized pieces at -18 °C. Do not freeze excessively large quantities. Once defrosted, food will not keep for as long and spoils more quickly than fresh food.

Leave the food to defrost in the freezer bag, on a plate or on the perforated cooking container. Always insert the baking tray underneath. The food is then not left lying in the defrost water and the cooking compartment remains clean.

Use the Steam operating mode.

If necessary, the meal can occasionally be split apart or pieces which have already defrosted can be removed from the appliance.

After defrosting, allow the food to stand for a further 5 - 15 minutes to come up to room temperature.

Health risk!

When defrosting food from animal sources, you must remove the liquid that escapes during defrosting. It must never come into contact with other food. Bacteria could be transferred. After defrosting, operate the combination steam oven for 15 minutes using Hot air at 180 °C.

Defrost meat

Allow pieces of meat which are to be breadcrumbed to defrost to the point where seasoning and breadcrumbs adhere to the meat.

Defrosting poultry

Remove from packaging before defrosting. You must tip the defrost liquid away.

Food	Amount	Accessories	Level	Temperature in °C	Cooking time in min.
Chicken	1 kg	perforated + baking tray	3 1	45 - 50	60 - 70
Chicken drumsticks	0.4 kg	perforated + baking tray	3 1	45 - 50	30 - 35
Vegetables frozen in blocks (e.g. spinach)	0.4 kg	perforated + baking tray	3 1	45 - 50	20 - 30
Berries	0.3 kg	perforated + baking tray	3 1	45 - 50	5 - 8
Fish fillet	0.4 kg	perforated + baking tray	3 1	45 - 50	15 - 20
Whole fish	1 kg	perforated + baking tray	3 1	45 - 50	40 - 50
Goulash	-	perforated + baking tray	3 1	45 - 50	40 - 50
Joint of beef	-	perforated + baking tray	3 1	45 - 50	70 - 80

Proving dough

With the Steam operating mode, dough proves significantly faster than at room temperature.

You may select any shelf position you wish for the wire rack or place the wire rack carefully on the cooking compartment floor. N.B.: Do not scratch the cooking compartment floor.

Stand the dough bowl on the wire rack. Do not cover the dough.

Food	Amount	Accessories	Temperature in °C	Cooking time in min.
Yeast dough	1 kg	bowl + wire rack	35	20 - 30
Sourdough	1 kg	bowl + wire rack	35	20 - 30

Juicing

Before juicing, place the berries in a bowl and sprinkle with sugar. Leave to stand for at least one hour to draw out the juice.

Add the berries to the perforated cooking container and insert at level 3. Slide the baking tray into level 1 to catch the juice. Finally, place the berries in a cloth and squeeze out the rest of the juice.

Food	Accessories	Level	Operating mode	Temperature in °C	Cooking time in min.
Raspberries	perforated cooking container + baking tray	3 1	Steam	100	30 - 45
Redcurrants	perforated cooking container + baking tray	3 1	Steam	100	40 - 50

Preserving

Preserve food which is as fresh as possible. When foods are stored for a relatively long period, their vitamin content is reduced and they ferment and spoil more easily.

Only use fruit and vegetables which are in perfect condition.

The following foods cannot be preserved with your appliance: Contents of tins, meat, fish or pastry dough.

Check preserving jars, rubber rings, clips and springs.

Clean rubber rings and jars thoroughly with hot water. The "Sterilise bottles" programme is also suitable for cleaning glasses.

Place the jars in the perforated cooking container. They must not be in contact with each other.

After the specified cooking time, open the appliance door.

Do not remove the preserving jars from the appliance until they have completely cooled down.

Food	Accessories	Level	Operating mode	Temperature in °C	Cooking time in min.
Vegetables	1-litre preserving jars	2	Steam	100	30 - 120
Stone fruits	1-litre preserving jars	2	Steam	100	25 - 30
Pip fruits	1-litre preserving jars	2	Steam	100	25 - 30

Frozen products

Observe the instructions on the packaging.

The cooking times indicated apply to dishes placed in a cold cooking compartment.

Food	Accessories	Level	Operating mode	Temperature in °C	Cooking time in min.
Chips	baking tray + greaseproof paper	2	Hot air	170 - 190	25 - 35
Croquettes	baking tray + greaseproof paper	2	Hot air	180 - 200	18 - 22
Rösti	baking tray + greaseproof paper	2	Hot air	180 - 200	25 - 30
Pasta, fresh, refrigerated*	baking tray	2	Steam	100	5 - 10
Lasagne, frozen	baking tray + wire rack	2	Combination	190 - 210	35 - 55
Pizza, thin base	baking tray + wire rack	2	Hot air	180 - 200	15 - 23
Pizza, deep pan	baking tray + wire rack	2	Hot air	180 - 200	18 - 25
Pizza baguette	baking tray + wire rack	2	Hot air	180 - 200	18 - 22
Pizza, chilled	baking tray	2	Hot air	170 - 180	12 - 17

* Add a little liquid

Food	Accessories	Level	Operating mode	Temperature in °C	Cooking time in min.
Herb butter baguette, refrigerated	baking tray	2	Hot air	180 - 200	15 - 20
Bread rolls, baguette, frozen	baking tray + wire rack	2	Hot air	180 - 200	18 - 22
Pretzels, frozen	baking tray + greaseproof paper	2	Hot air	180 - 200	18 - 22
Croissant, frozen	baking tray + greaseproof paper	2	Combination	180 - 200	20 - 25
Part-cooked rolls or baguette, pre-baked	baking tray + greaseproof paper	2	Hot air	150 - 170	12 - 15
Strudel, frozen	baking tray + greaseproof paper	2	Combination	160 - 180	45 - 60
Fish fingers	baking tray + greaseproof paper	2	Hot air	195 - 205	20 - 24
Trout	perforated + baking tray	3 1	Steam	80 - 100	20 - 25
Frozen fish fillet	baking tray + wire rack	2	Combination	180 - 200	35 - 50
Salmon fillet	perforated cooking container + baking tray	3 1	Steam	80 - 100	20 - 25
Squid rings	baking tray + greaseproof paper	2	Hot air	190 - 210	25 - 30
Broccoli	perforated cooking container + baking tray	3 1	Steam	100	4 - 6
Cauliflower	perforated cooking container + baking tray	3 1	Steam	100	5 - 8
Beans	perforated cooking container + baking tray	3 1	Steam	100	4 - 6
Peas	perforated cooking container + baking tray	3 1	Steam	100	4 - 6
Carrots	perforated cooking container + baking tray	3 1	Steam	100	3 - 5
Mixed vegetables	perforated cooking container + baking tray	3 1	Steam	100	4 - 8
Brussels sprouts	perforated cooking container + baking tray	3 1	Steam	100	5 - 10

* Add a little liquid

Test dishes

In accordance with EN 50304/EN 60350 (2009), and IEC 60350.

The values in the table apply to dishes placed in a cold cooking compartment.

Food	Accessories	Level	Operating mode	Temperature in °C	Cooking time in min.
Piped cookies	Baking tray	2	Hot air	160 - 170	17 - 20
Small cakes	Baking tray	2	Hot air	160 - 170	25 - 33
Hot water sponge cake	26 cm springform cake tin	2	Hot air	150 - 160	35 - 40
German apple pie	20 cm springform cake tin	2	Hot air	160 - 170	60 - 70

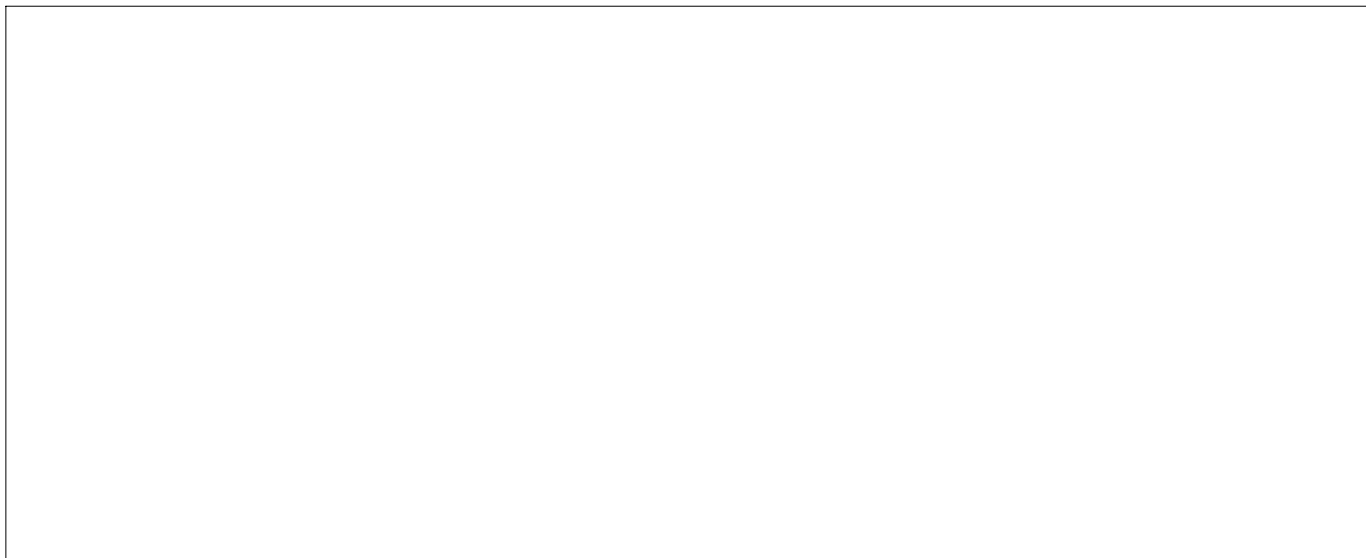

Robert Bosch Hausgeräte GmbH

Carl-Wery-Straße 34

81739 München

Germany

www.bosch-home.com



9000765235