



HB36D.75. / HB36D585

Combination steam oven

SIEMENS

Important safety information	4	Basic settings	19
Causes of damage	5	Automatic switch-off	19
Your new appliance	6	Care and cleaning	20
Control panel	6	Cleaning agents.....	20
Rotary selector	6	Cleaning aid.....	21
Display	6	Descaling	21
Temperature indicator.....	7	Removing and fitting the appliance door.....	22
Types of heating.....	7	Cleaning the door panels.....	23
Automatic calibration	7	Cleaning the rails.....	23
Your accessories	8	Troubleshooting	24
Accessories	8	Replacing the cooking compartment bulb	25
Inserting accessories	8	Changing the door seal.....	25
Cooking compartment	8	After-sales service	26
Optional accessories	8	E number and FD number.....	26
Before using the appliance for the first time	9	Environmental protection	26
Setting the clock and language	9	Environmental protection	26
Setting the water hardness range	9	Tips for saving energy	26
Before first use	9	Tables and tips	26
Cleaning the accessories before use	9	Steam.....	26
Fitting the grease filter in place.....	9	Hot air	27
Operating the appliance	10	Hot air + Steam	27
Filling the water tank	10	Vegetables	27
Switching on the appliance.....	10	Side dishes and pulses	28
Switching off the appliance.....	11	Poultry and meat.....	28
After each use	11	Fish.....	30
Recommended settings	11	Slow cooking meat.....	30
Time-setting options	12	Bakes, soup ingredients, etc.....	31
Set the timer.....	12	Dessert, compote	31
Setting the cooking time.....	12	Cakes and pastries	31
Setting a later end time	12	Reheating food.....	33
Setting the clock	13	Defrosting.....	33
Automatic programmes	13	Proving dough.....	34
Setting a programme	13	Juicing.....	34
Notes about the programmes	14	Preserving	34
Programme tables	14	Frozen products.....	34
Memory	18	Test dishes	35
Saving to the Memory function	18		
Starting the memory function	18		
Childproof lock	19		
Activating the childproof lock	19		
Deactivating the childproof lock	19		

Additional information on products, accessories, replacement parts and services can be found at www.siemens-home.com and in the online shop www.siemens-eshop.com

Important safety information

Read these instructions carefully. Only then will you be able to operate your appliance safely and correctly. Retain the instruction manual and installation instructions for future use or for subsequent owners.

This appliance is only intended to be fully fitted in a kitchen. Observe the special installation instructions.

Check the appliance for damage after unpacking it. Do not connect the appliance if it has been damaged in transport.

Only a licensed professional may connect appliances without plugs. Damage caused by incorrect connection is not covered under warranty.

This appliance is intended for domestic use only. The appliance must only be used for the preparation of food and drink. The appliance must be supervised during operation. Only use this appliance indoors.

This appliance may be used by children over the age of 8 years old and by persons with reduced physical, sensory or mental capacity or by persons with a lack of experience or knowledge if they are supervised or are instructed by a person responsible for their safety how to use the appliance safely and have understood the associated hazards.

Children must not play with the appliance. Children must not clean the appliance or carry out general maintenance unless they are at least 8 years old and are being supervised.

Keep children below the age of 8 years old at a safe distance from the appliance and power cable.

Always slide accessories into the cooking compartment correctly. See "*Description of accessories*" in the instruction manual.

Risk of fire!

- Combustible items stored in the cooking compartment may catch fire. Never store combustible items in the cooking compartment. Never open the appliance door if there is smoke inside. Switch off the appliance and unplug it from the mains or switch off the circuit breaker in the fuse box.
- A draught is created when the appliance door is opened. Greaseproof paper may come into contact with the heating

element and catch fire. Do not place greaseproof paper loosely over accessories during preheating. Always weight down the greaseproof paper with a dish or a baking tin. Only cover the surface required with greaseproof paper. Greaseproof paper must not protrude over the accessories.

Risk of burns!

- The appliance becomes very hot. Never touch the interior surfaces of the cooking compartment or the heating elements. Always allow the appliance to cool down. Keep children at a safe distance.
- Accessories and ovenware become very hot. Always use oven gloves to remove accessories or ovenware from the cooking compartment.
- Alcoholic vapours may catch fire in the hot cooking compartment. Never prepare food containing large quantities of drinks with a high alcohol content. Only use small quantities of drinks with a high alcohol content. Open the appliance door with care.
- Hot steam may escape during operation. Do not touch the ventilation openings. Keep children away.

Risk of scalding!

- The accessible parts become hot during operation. Never touch the hot parts. Keep children at a safe distance.
- Water in a hot cooking compartment may create hot steam. Never pour water into the hot cooking compartment.
- When you open the appliance door, hot steam can escape. Steam may not be visible, depending on its temperature. When opening, do not stand too close to the appliance. Open the appliance door carefully. Keep children away.
- The water in the evaporator dish is still hot even after the appliance has been switched off. Do not empty the evaporator dish immediately after switching off the appliance. Allow the appliance to cool down before cleaning it.
- Hot liquid may spill over the sides of cooking containers when they are removed from the cooking compartment. Remove hot cooking containers with care and always wear oven gloves.

Risk of injury!

- Scratched glass in the appliance door may develop into a crack. Do not use a glass scraper, or sharp or abrasive cleaning aids or detergents.
- Flammable liquids can catch fire in the cooking compartment when it is hot (explosion). Do not fill the water tank with any flammable fluids (e.g. alcoholic drinks). Only fill the water tank with water or with the descaling solution that is recommended by us.

Risk of electric shock!

- Incorrect repairs are dangerous. Repairs may only be carried out by one of our trained after-sales engineers. If the appliance is faulty, unplug the mains plug or switch off the fuse in the fuse box. Contact the after-sales service.
- The cable insulation on electrical appliances may melt when touching hot parts of the appliance. Never bring electrical appliance cables into contact with hot parts of the appliance.
- Penetrating moisture may cause an electric shock. Do not use any high-pressure cleaners or steam cleaners.
- When replacing the cooking compartment bulb, the bulb socket contacts are live. Before replacing the bulb, unplug the appliance from the mains or switch off the circuit breaker in the fuse box.
- A defective appliance may cause electric shock. Never switch on a defective appliance. Unplug the appliance from the mains or switch off the circuit breaker in the fuse box. Contact the after-sales service.

Causes of damage

Caution!

- Do not place anything on the cooking compartment floor. Do not cover it with aluminium foil. A build-up of heat could damage the appliance.
The cooking compartment floor and the evaporator dish must always be kept clear. Always place ovenware in a perforated cooking container or on a wire rack.
- Aluminium foil in the cooking compartment must not come into contact with the door panel. This could cause permanent discolouration of the door panel.
- Ovenware must be heat and steam resistant. Silicone baking tins are not suitable for combined operation with steam.
- Do not use ovenware that shows signs of rust. Even the smallest spots of rust can lead to corrosion in the cooking compartment.
- When steaming with a perforated cooking container, always insert the baking tray or the solid cooking container underneath. Dripping liquid is caught.
- Do not store moist food in the closed cooking compartment for long periods. It can lead to corrosion in the cooking compartment.
- Fruit juice may leave stains in the cooking compartment. Always remove fruit juice immediately and wipe the cooking compartment with a moist and dry cloth.
- If the door seal is very dirty, the appliance door will no longer close properly during operation. The fronts of adjacent units could be damaged. Always keep the door seal clean and replace when necessary.
- Do not place anything on the open appliance door. The appliance could be damaged.
- Do not carry or hold the appliance by the door handle. The door handle cannot support the weight of the appliance, and could break.
- The cooking compartment in your appliance is made of high grade stainless steel. Improper care can lead to corrosion in the cooking compartment. Refer to the care and cleaning instructions in the instruction manual. Remove food residues from the cooking compartment as soon as the appliance has cooled.

Your new appliance

In this section, you will find information on

- the control panel
- the types of heating
- automatic calibration

Control panel

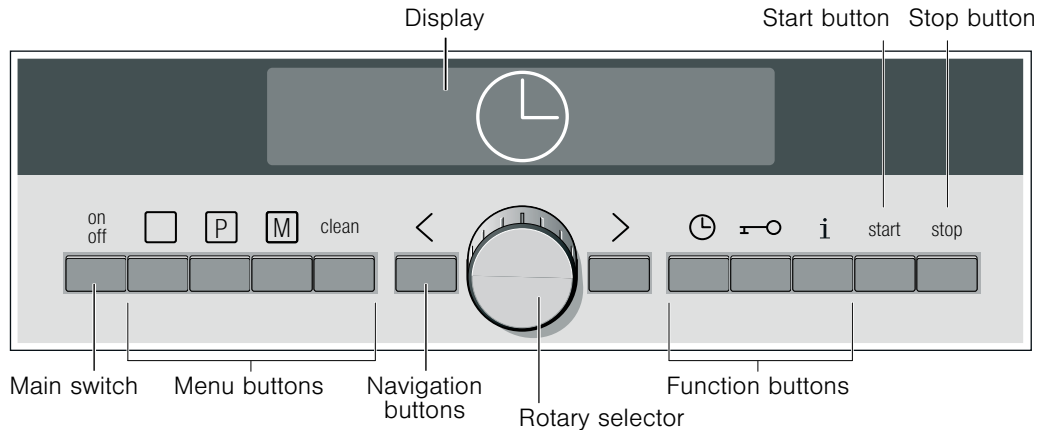

Control element		Use
Main switch	on off	Switching the appliance on and off
Menu buttons	<input type="checkbox"/>	Selecting the type of heating
	P	Selects a programme (see section: Automatic programmes)
	M	Saves and calls up the memory function (see section: Memory)
	clean	Selects the cleaning aid and descaling function (see section: Care and cleaning)
Navigation buttons	< >	Moves left or right in the display. Modifications are saved
Rotary selector:		Changes values for the clock, cooking time, weight etc. Press the rotary selector to lock and unlock
Function buttons		Selects time-setting options (see section: Time-setting options)
		Switches the childproof lock on and off (see section: Childproof lock)
	i	If the appliance is switched on: calls up current information If the appliance is switched off: selects basic settings (see section: Basic settings)
Start button	start	Starts cooking
Stop button	stop	Short press: stops cooking (pause)
		Press and hold: ends cooking

Rotary selector

The rotary selector is used to alter the default values and set values.

The rotary selector is retractable. Press on the rotary selector to pop it in or out.

Display

Shortly after switching off the appliance, the display switches to the energy saving mode. The display gets darker.

The display is divided into different areas:

- Status line
- Progress indicator
- Settings range
- Rotation direction indicator

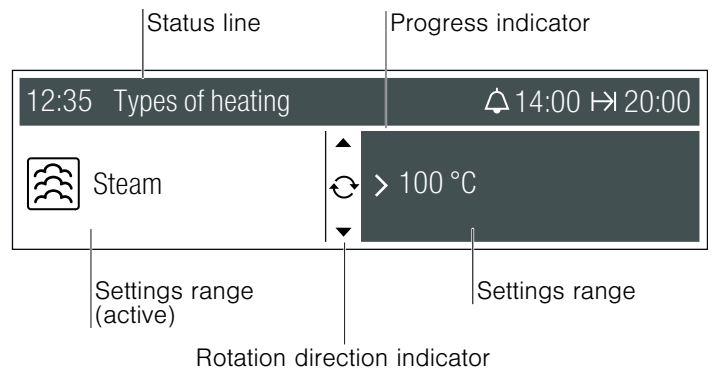

Status bar

The status bar is located at the top of the display. It shows the clock, the selected operating mode, instructions, information and the time-setting options that have been set.

Progress display

The progress display provides you with a quick overview of the cooking time as it counts down. It appears as a line under the status bar after the cooking time starts. The line begins on the left and becomes longer as the cooking time progresses. The line reaches the right-hand extremity of the display once the cooking time has elapsed.

Settings areas

The two settings areas show suggested values that you can change. The settings area which is currently active has a light background with black writing. You can make changes here.

You can use the < and > navigation buttons to switch from one settings area to the next one. The < and > arrows in the settings areas show you which way you can go with the navigation buttons.

Once you start the oven, both settings areas are dark with light writing.

Rotation direction indicator

The  indicator shows the direction in which you can move the rotary selector.

 = turn the rotary selector clockwise

 = turn the rotary selector anti-clockwise

If both direction arrows are shown, you can turn the rotary selector in either direction.

Temperature indicator

The temperature indicator bars show the heating phases or residual heat in the cooking compartment.

Heating indicator

The heating indicator displays the rising temperature in the cooking compartment.

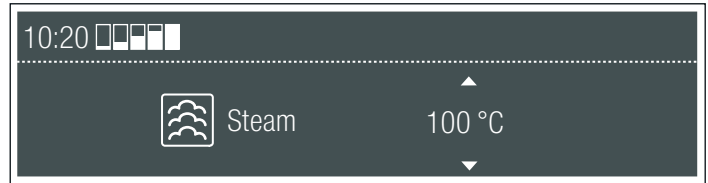

The bars do not appear when settings are made for cleaning.

You can use the **i** button to check the current heating temperature when heating up. Due to thermal inertia, the temperature displayed may be slightly different to the actual temperature inside the oven.

Residual heat

The temperature indicator shows the residual heat in the cooking compartment when the appliance is switched off. If the last bar is filled, the temperature in the cooking compartment is approximately 300 °C. Once the temperature has dropped to approximately 60 °C, the display goes out.

Types of heating

You can use the  button to set your appliance for various applications.

Type of heating	Used for
Hot air	30 - 230 °C for moist cakes, sponge, pot roasts. A fan in the back wall of the oven distributes the heat evenly inside the cooking compartment.
Steam	35 - 100 °C For vegetables, fish, side dishes, for juicing fruit and for blanching.
Hot air + Steam	120 - 230 °C for meat, bakes and baked goods. Hot air and steam are combined.
Reheat	100 - 180 °C for plated meals and baked items. Cooked food is gently reheated. The steam ensures that the food does not dry out.
Prove	35 - 50 °C for yeast dough and sourdough. Dough will prove considerably more quickly than at room temperature. Hot air and steam are combined so that the surface of the dough does not dry out
Defrosting	35 - 60 °C for vegetables, meat, fish and fruit. Hot air and steam are combined. The moisture gently transfers the heat to the food. The food does not dry out or lose shape.
Slow cook	60 - 120 °C for sirloin, leg of lamb. Tender pieces of meat stay particularly juicy.
Plate warming	30 - 70 °C for porcelain tableware. Food does not cool down so quickly on preheated plates and dishes. Drinks also remain warm for longer.
Keep warm	60 - 100 °C for keeping food warm for up to two hours

Automatic calibration

The boiling temperature of water depends on the air pressure. During calibration, the appliance is adapted to the pressure conditions in the location where it is installed. This happens automatically when you first use the appliance (see section: First use). More steam develops than usual.

It is important that the appliance steams without interruption for 20 minutes at 100 °C. Do not open the appliance door during this time.

If the appliance was not able to calibrate itself automatically (for example, because the appliance door was opened), the calibration process is carried out again during the next cooking operation.

After moving house

So that the appliance automatically adjusts itself to its new location, you must reset the appliance to the factory settings (see section: Basic settings) and repeat the initial start-up process (see section: First use).

After a power cut

The appliance saves the calibration settings even in the event of a power cut or disconnection from the mains. Recalibration is not necessary.

Your accessories

The accessories supplied with your appliance are suitable for making many dishes. Ensure that you always insert the accessories into the cooking compartment the right way round.

Accessories

The following accessories are supplied with your appliance:

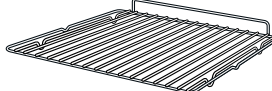
- 

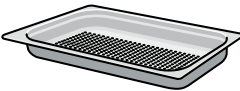
Wire rack
For ovenware, cakes and ovenproof dishes, and for roasting
- 

Cooking container, perforated, GN 1/3, 40 mm deep
For steaming vegetables, juicing berries and defrosting
- 

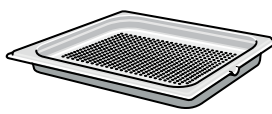
Cooking container, solid, GN 1/3, 40 mm deep
For cooking rice, pulses and cereals
- 

Cooking container, perforated, GN 2/3, 40 mm deep
for the steaming of whole fish or large quantities of vegetables, for juicing berries, etc.
- 

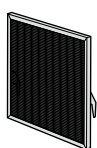
Cooking container, solid, GN 2/3, 28 mm deep (baking tray)
For baking tray bakes and for catching dripping liquid during steaming
- 

Grease filter
protects the fan of the back panel of the cooking compartment from becoming dirty (e.g. from spattering)

You can buy accessories from the after-sales service, from specialist retailers or online.

Note: The cooking containers may warp during and after cooking. This is caused by the considerable temperature differences acting on the accessories. It may occur if only a part of the accessory is occupied with food or if you place frozen items, such as pizza, on the accessory. Once accessories cool down again, they regain their original shape. This does not affect their function.

Inserting accessories

The accessories are equipped with a locking function. The locking function prevents the accessories from tilting when they are pulled out. The accessories must be inserted into the cooking compartment correctly for the tilt protection to work properly.

When inserting the wire rack, check

- that the lug (a) is pointing downwards
- that the safety lug on the wire rack is at the back and facing upwards.

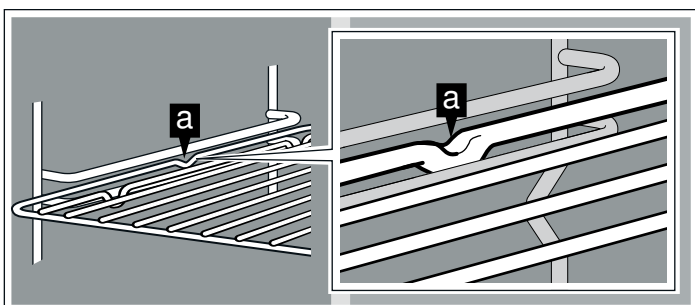

When inserting the cooking container, ensure that the lug (a) is facing downwards.

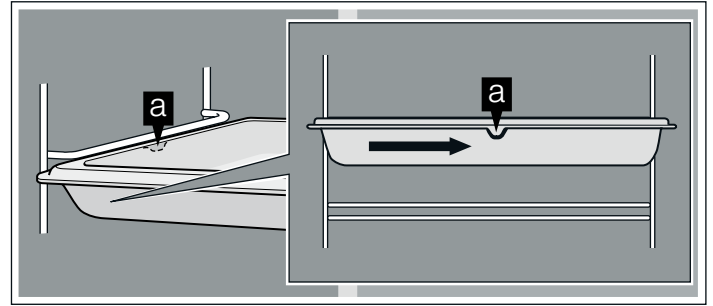

Cooking compartment

The cooking compartment has four shelf positions. The shelf positions are counted from the bottom up.

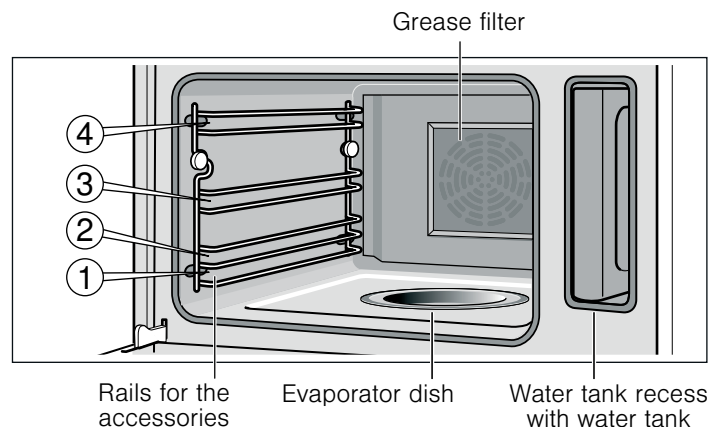

Caution!

- Do not place anything on the cooking compartment floor. Do not cover it with aluminium foil. A build-up of heat could damage the appliance.
The cooking compartment floor and the evaporator dish must always be kept clear. Always place ovenware in a perforated cooking container or on a wire rack.
- Do not slide any accessories between the shelf positions, or they may tip.

Optional accessories

You can obtain further accessories from specialist retailers:

Accessories	Order no.
Cooking container, solid, GN 2/3, 40 mm deep	HZ36D543
Cooking container, perforated, GN 2/3, 40 mm deep	HZ36D543G
Cooking container, solid, GN 2/3, 28 mm deep (baking tray)	HZ36D542
Cooking container, solid, GN 1/3, 40 mm deep	HZ36D513
Cooking container, perforated, GN 1/3, 40 mm deep	HZ36D513G
Porcelain cooking container, solid, GN 2/3	HZ36D533P
Porcelain cooking container, solid, GN 1/3	HZ36D513P
Wire rack	HZ36DR4
Roasting set	HZ36DB4
Grease filter	HZ36DF
Cleaning sponge	643 254

Accessories	Order no.
Descaler	311 138
Honeycomb microfibre cloth	460 770

Before using the appliance for the first time

In this section you will find out which steps are required before using the appliance for the first time:

- Setting the clock and language
- Setting the water hardness range
- Starting the appliance for the first time
- Cleaning the accessories before use
- Fitting the grease filter

Setting the clock and language

After making the electrical connection, "Clock" and "Select language" appear in the display. Set the clock and the language for the display, if required.

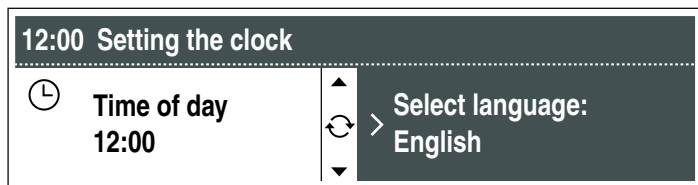

1. Set the current time using the rotary selector.
2. Press the > button to switch to "select language".
3. Set the required language using the rotary selector.
4. Press the ⌚ button.
The time and language are saved. The current time is displayed.

Setting the water hardness range

Descale your appliance regularly. This is the only way to prevent damage.

Your appliance automatically displays when it needs descaling. It has been preset to water hardness range "medium". Change the value if your water is softer or harder.

You can check the water hardness with the test strips supplied or ask your water supplier.

If your water is very hard, we recommend that you use softened water.

You can only dispense with descaling completely if you exclusively use softened water. If this is the case, change the water hardness to "softened".

You can change the water hardness range in the basic settings when the appliance is switched off.

1. If required, press the off button to switch off the appliance.
2. Press and hold the i button until "Select language" appears in the display.
3. Press the > button until "water hardness" appears. "2-medium" is highlighted in the display.
4. Change the water hardness using the rotary selector.
Possible values:

softened	-
1-soft	I
2-medium	II
3-hard	III
4-very hard	IV

5. Press the i button to exit the basic settings.
The change is saved.

Before first use

Before using the appliance for the first time, heat it up while still empty in the "Steam" type of heating to 100 °C for 20 minutes. Do not open the appliance door during this time. The appliance is automatically calibrated (see section: Automatic calibration).

1. Press the off button to switch on the appliance.
The "Hot air" type of heating appears after approx. 4 seconds.
2. Fill and insert the water tank (see section: Filling the water tank).
Before using for the first time, moisten the seal in the tank cover with a little water.
3. Turn the rotary selector until "Steam" appears.
4. Press the Start button.
The appliance heats up to 100 °C. The cooking time (20 minutes) does not start to count down until the set temperature has been reached. Do not open the appliance door during this time.
The cooking operation automatically ends and a signal sounds.
5. Press the off button to switch off the appliance.
Leave the appliance door ajar until the appliance has cooled down.

Cleaning the accessories before use

Using soapy water and a soft cloth, clean the accessories thoroughly before first use.

Fitting the grease filter in place

Hook the enclosed grease filter onto the hot air grille in the back wall of the cooking compartment.

Leave the grease filter in the cooking compartment for all applications.

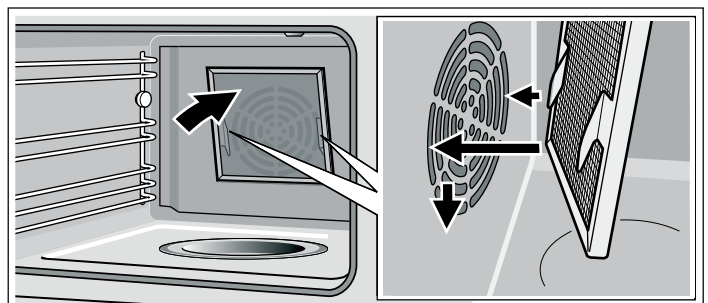

⚠ Risk of injury!

You could hurt yourself on the grease filter hooks. Always clean the grease filter with care. Always place the grease filter in the dishwasher so that the hooks for fixing it in place are facing downwards.

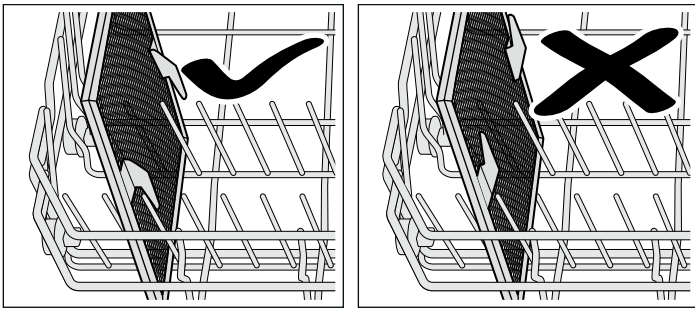

Clean the grease filter with hot soapy water or in the dishwasher every time heavy dirt deposits have been left behind after cooking.

Operating the appliance

In this section, you can read about

- how to fill the water tank
- how to switch the appliance on and off
- what to note after each use
- how you can use the recommended settings

Filling the water tank

When you open the appliance door, you will see the water tank on the right-hand side.

Caution!

Use of unsuitable liquids may damage the appliance

- Only use fresh tap water, softened water or uncarbonated mineral water.
- If your tap water is very hard, we recommend that you use softened water.
- Do not use distilled water, highly chlorinated tap water (> 40 mg/l) or other liquids.

You can obtain information about your tap water from your water supplier. The water hardness can be checked with the test strips enclosed.

Fill the water tank before each use:

1. Open the appliance door and take out the water tank (fig. A).
2. Fill the water tank with cold water up to the "max" mark (fig. B).

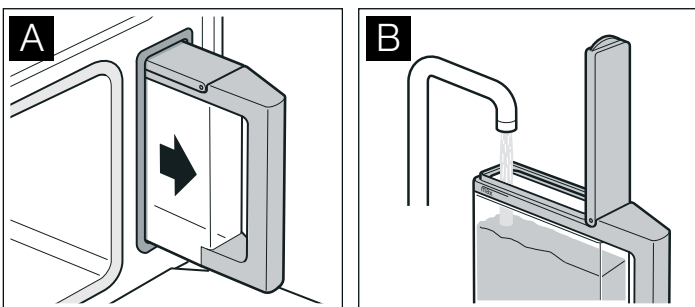

3. Close the tank cover until you feel it engage.
4. Slide in the water tank all the way (fig. C).

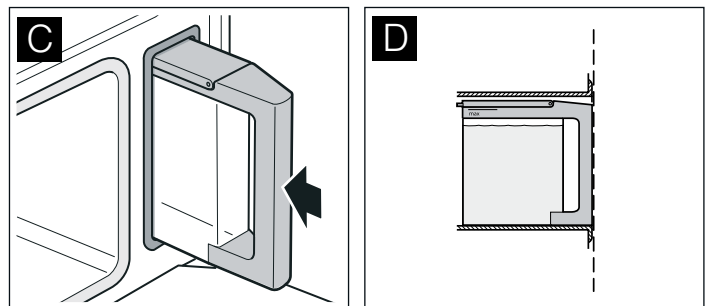

The tank must be flush with the water tank recess (fig. D).

Switching on the appliance

⚠ Risk of scalding!

When you open the appliance door and remove the cooking containers, hot liquids may squirt out because the cooking containers may have warped. When opening, do not stand too close to the appliance. Open the appliance door carefully. Remove the cooking container carefully. Keep children at a safe distance.

Note: Always use the cooking container and wire rack in their standard position (not the other way up).



1. Press the **off** button to switch on the appliance. The brand name logo appears on the display for approx. 4 seconds. The display then switches automatically to the "Types of heating" menu. Alternatively, press the **□** button to go directly to the "Types of heating" menu.
2. Turn the rotary selector to set the desired type of heating.

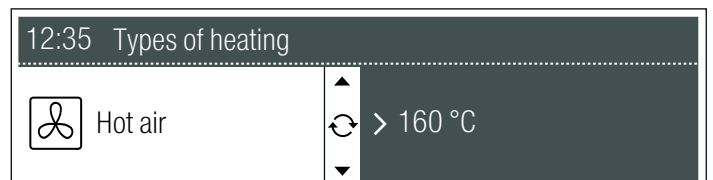



3. Press the **>** button. The default temperature is highlighted.

4. Turn the rotary selector to set the desired temperature.

Type of heating	Temperature range	Default cooking time
Hot air	30 - 230 °C	-
Steam	35 - 100 °C	20 minutes
Hot air + Steam	120 - 230 °C	30 minutes
Reheat	100 - 180 °C	10 minutes
Prove	35 - 50 °C	30 minutes
Defrost	35 - 60 °C	30 minutes
Slow cook	60 - 120 °C	-
Plate warming	30 - 70 °C	-
Keep warm	60 - 100 °C	-

For types of heating involving steam, you must now set a cooking time (see also section: Time-setting options):

5. Press the  button.

"Timer"  appears in the display.

6. Switch to the  Cooking time using the  button.

7. Turn the rotary selector to set the required cooking time.

8. Press the  button.

9. Press the Start button to start cooking.

The appliance heats up.

For the Steam type of heating, the cooking time only starts counting down after the heating-up time is complete.

"Fill water tank?" message

This message appears if you set a type of heating and the water tank is only half full.

If you think that the water in the water tank is sufficient for the cooking procedure, you can start the appliance. If not, fill the water tank to the "max" mark, slide it back in and start the appliance.

Current temperature

Press the  button.

The current temperature is displayed for 10 seconds.

The heating indicator bars next to the clock show the rising temperature in the cooking compartment.

Changing the temperature

You can change the temperature at any time with the rotary selector. The change is adopted automatically.

Pause

Briefly press the Stop button to interrupt cooking (pause). The cooling fan may continue to run. Press the Start button to restart.

If you open the appliance door during operation, operation is interrupted. Close the appliance door and press the Start button to restart.

If you have changed the basic setting "Continue after closing door" to "automatic", restarting is not required (see section: Basic settings).

"Fill water tank" message

If the water tank is empty, a signal sounds. "Fill water tank" appears on the display. Cooking is interrupted.

1. Open the appliance door carefully.
N.B.: Hot steam will escape.

2. Remove the water tank, fill up to the "max" mark and slide the tank back in.

3. Press the Start button.

Switching off the appliance

Risk of scalding!

Hot steam may escape when the appliance door is opened. Open the appliance door carefully during or after cooking. When opening the door, do not lean over it. Ensure that, depending on the temperature, steam is not visible.

Press and hold the Stop button to end cooking. If you have set a cooking time, cooking is ended automatically. A signal sounds.

Press the  button to switch off the appliance.

The cooling fan may continue running when you open the appliance door.

After each use

Emptying the water tank.

1. Open the appliance door carefully.

Hot steam will escape.

2. Remove and clean the water tank.

3. Thoroughly dry the seal in the tank cover and the tank recess in the appliance.

Caution!

Do not dry the water tank in the hot cooking compartment. This will damage the water tank.

Drying the cooking compartment

Risk of scalding!

The water in the evaporator dish may still be hot. Allow it to cool before wiping.

1. Leave the appliance door ajar until the appliance has cooled down.

2. Once it has cooled down, wipe out the cooking compartment and the evaporator dish with the enclosed cleaning sponge and dry well with a soft cloth.

3. Remove food residues from the cooking compartment as soon as the appliance has cooled. Burnt-on remains will be much harder to remove later.

4. Wipe kitchen units or handles if condensation has formed on them.

Recommended settings

If you choose a dish from the recommended settings, the ideal setting values are already specified.

You can choose from many different categories. Our recommended settings include a large number of dishes from cakes, bread, poultry, meat, fish and game to bakes and convenience products.

The dishes can be found via several selection levels. Try it out and see for yourself the variety of dishes.

1. Press the  button.

"Hot air 160 °C" appears in the display.

2. Turn the rotary selector anti-clockwise to  "Recommended settings".

The first food category appears in the display.

3. Using the  button, switch to the food category and select the desired category with the rotary selector.

(Use the  button to move to the next level. Use the rotary selector to move each time to the next selection.)

The setting for the selected dish then appears. You can change the temperature and cooking time but not the type of heating.

4. Press the Start button.

The cooking operation starts. The cooking time  appears in the display and starts to count down.

The cooking time has elapsed

A signal sounds. The appliance stops heating. I→I "0:00" appears in the display.

Press the ⏸ button to stop the signal.

Changing the temperature

You can change the temperature at any time using the rotary selector.

Changing the cooking time

Press the ⏸ button. Switch to the cooking time using the > button. Change the duration using the rotary selector. Exit the time-setting options using the ⏸ button.

Checking information

Press the i button.

For more information, press the i button again.

Time-setting options

The time-setting options are called up with the ⏸ button. The following functions are available:

When the appliance is switched off:

- Setting the timer
- Setting the clock

When the appliance is switched on:

- Setting the timer
- Setting the cooking time
- Setting a later end time

Setting time-setting options - in brief

1. Press the ⏸ button.
2. Press the < or > button to switch to the required time-setting option.
3. Set the required time or cooking time using the rotary selector.
4. Exit the time-setting options with the ⏸ button.

Set the timer

The timer runs independently of the cooking mode. You can use it like a kitchen timer and set it at any time.

1. Press the ⏸ button.
2. Set the timer duration using the rotary selector.
3. Exit the time-setting options with the ⏸ button.
The display switches to its previous state. The ⏰ symbol for the timer appears, and the time can be seen counting down.

Changing the timer duration

Press the ⏸ button. In the next few seconds, change the timer duration using the rotary selector. Exit the time-setting options with the ⏸ button.

Once the timer duration has elapsed

A signal sounds. ⏰ "0:00" appears in the display. Press the ⏸ button to stop the signal.

Cancelling the timer duration

Press the ⏸ button. Turn the timer back to "0:00" using the rotary selector. Exit the time-setting options with the ⏸ button.

Setting the cooking time

If you set a cooking time for your dish, cooking stops automatically once this time has elapsed. The appliance stops heating.

For types of heating involving steam, you must always set a cooking time.

Example in the picture: Setting a cooking time of 45 minutes.

Requirement: The type of heating and temperature have been set.

1. Press the ⏸ button.

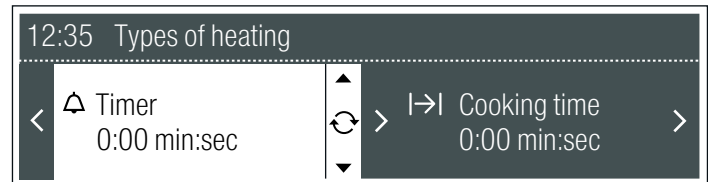

2. Switch to the cooking time using the > button.
3. Set the cooking time using the rotary selector.

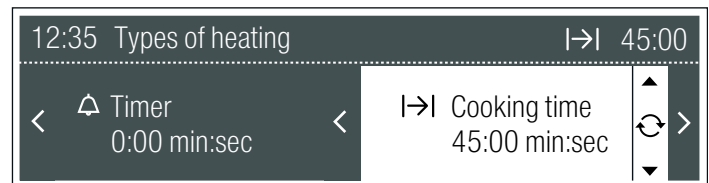

4. Exit the time-setting options with the ⏸ button.
5. If the operation has not yet started, press the Start button.
The I→I cooking time counts down on the display.
For the Steam type of heating, the cooking time starts counting down after the heating-up time.

Changing the cooking time

Press the ⏸ button. Switch to the cooking time using the > button and change the cooking time using the rotary selector. Exit the time-setting options with the ⏸ button.

The cooking time has elapsed

A signal sounds. The appliance stops heating. The I→I cooking time "0:00" appears in the display. Press the ⏸ button to stop the signal.

Cancelling the cooking time

Press the ⏸ button. Switch to the cooking time using the > button and set it to 0:00 with the rotary selector. Exit the time-setting options with the ⏸ button.

Setting a later end time

You can change the time at which you wish your dish to be ready. The appliance starts automatically and is ready at the desired time. You can, for example, put your dish in the compartment in the morning and set the cooking time so that it is ready at lunch time.

Ensure that food is not left in the cooking compartment for too long as it may spoil.

For some programmes it is not possible to change the end time.

For the Steam type of heating, the cooking time starts counting down after the heating-up time. The selected end time is delayed by the length of the heating-up time.

Example in the picture: It is 9:30, the dish takes 45 minutes to cook, but is not to be ready until 12:45.

Requirement: The cooking operation which was set has not started. A cooking time is set. The ⏸ time-setting options are open.

1. Press the \rightarrow button to switch to $>$ "End".
The time at which the operation will finish is shown in the display.

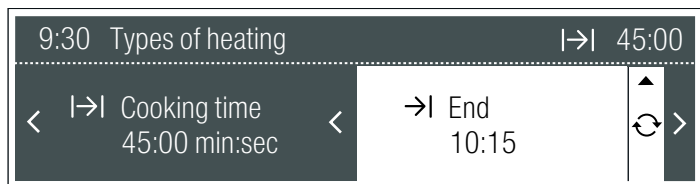

2. Use the rotary selector to set a later end time.

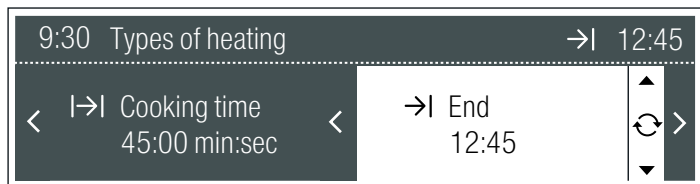

3. Exit the time-setting options with the \ominus button.
4. Confirm with the Start button.
The setting is applied. The appliance is in standby. The \rightarrow end time is shown in the display. The cooking operation starts at the appropriate time. The cooking time counts down in the display.

Changing the end time

The end time can be changed provided the appliance is in standby. Press the \ominus button. Switch to \rightarrow "End" using the $>$ button and turn the rotary selector to change the end time. Exit the time-setting options with the \ominus button.

The cooking time has elapsed

A signal sounds. The appliance stops heating. The \rightarrow cooking time "0:00" appears in the display. Press the \ominus button to stop the signal.

Cancelling the end time

The end time can be cancelled provided the appliance is in standby. Press the \ominus button. Press the \rightarrow button to switch to $>$ "End". Turn back the end time using the rotary selector until the display goes out. Exit the time-setting options with the \ominus button. The selected cooking time starts counting down straight away.

Setting the clock

So that you can set the clock, you must switch off the appliance.

Example: changing from summer to winter time.

1. Switch off the appliance.
2. Press the \ominus button.
3. Press the $>$ button to switch to the \ominus clock.
4. Use the rotary selector to change the clock.
5. Exit the time-setting options with the \ominus button.

After a power cut

After a power cut, "Set clock" will appear in the display. Set the current time using the rotary selector. Exit the time-setting options with the \ominus button. The time is applied.

Changing the clock display

When the appliance is switched off, the current time appears on the display. You can change this display (see section: Basic settings).

Automatic programmes

The automatic programmes enable you to prepare food very easily. There are 16 programme groups containing a total of 70 programmes.

In this section, you will find out

- how to set one of the automatic programmes
- hints and tips on the programmes
- Which programmes you can set (programme tables)

Setting a programme

Select a suitable programme from the programme table. Follow the instructions for the programmes.

Example in the picture: you want to steam 500 g fresh chicken breast.

- Programme group "Poultry"
- Programme "Chicken breast, fresh, steamed"

Selecting a programme group

1. Press the off button to switch on the appliance.
2. Press the P button.
The first programme group, "Vegetables", appears in the display.
3. Turn the rotary selector until the required programme group appears.

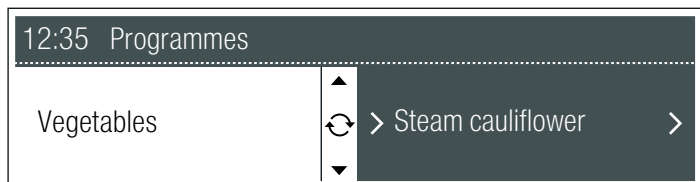

Selecting the programme

4. Press the $>$ button.
The first programme of the selected programme group is highlighted.
5. Turn the rotary selector until the required programme appears.

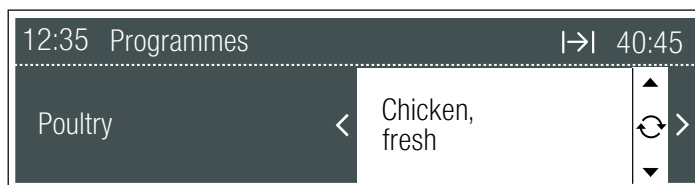

Enter the weight

6. Press the $>$ button.
The recommended weight is highlighted.
7. Turn the rotary selector to set the weight of the items to be cooked.

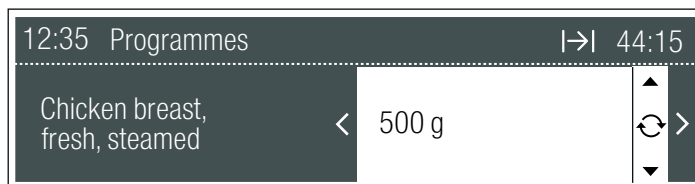

Adjusting the cooking result to suit individual tastes

8. Press the $>$ button.
The individual adjustment is highlighted "- □□□□■□ +".

9. Turn the rotary selector to adjust the cooking result.

- Anti-clockwise: set a less intensive cooking result
- Clockwise: set a more intensive cooking result

You can also modify the cooking result permanently for all programmes at the same time (see section: Basic settings).

10. Press the Start button to start the programme.

The programme cooking time counts down in the display. No heating indicator appears.

Set a later end time

You can delay the end time for some programmes. The programme will be started later and finish at the desired time (see section: Time-setting options).

Cancelling the programme

Press and hold the Stop button.

End of the programme

A signal sounds. Cooking has finished. Press the  button to switch off the appliance.

Risk of scalding!

Hot steam may escape when the appliance door is opened. Open the appliance door carefully during or after cooking.

Programme tables

Follow the instructions for the programmes.

Vegetables

Do not season vegetables until after cooking.

Programme	Note	Accessories	Level
Steam cauliflower/In florets*	florets of equal size	Perforated cooking container + Baking tray	3 1
Steam broccoli florets*	florets of equal size	Perforated cooking container + Baking tray	3 1
Steam green beans*	-	Perforated cooking container + Baking tray	3 1
Sliced carrots, steam*	slices, approx. 3 mm thick	Perforated cooking container + Baking tray	3 1
Sliced kohlrabi, steam*	slices, approx. 3 mm thick	Perforated cooking container + Baking tray	3 1
Steam Brussels sprouts*	-	Perforated cooking container + Baking tray	3 1
Steam asparagus/White asparagus*	-	Perforated cooking container + Baking tray	3 1
Steam asparagus/Green asparagus*	-	Perforated cooking container + Baking tray	3 1
Mixed vegetables frozen, steam	-	Perforated cooking container + Baking tray	3 1

* You can delay the end time for this programme

When opening the door, do not lean over it. Ensure that, depending on the temperature, steam is not visible.

Notes about the programmes

All programmes are designed for cooking on one level.

The cooking result can vary according to the size and quality of the food.

Ovenware

Use the suggested ovenware. All meals have been tested using this ovenware. The cooking result may change if you use different ovenware.

When cooking in the perforated cooking container, always insert the baking tray at level 1. Dripping liquid is caught.

Amount/weight

Do not fill the food more than 4 cm deep in the accessories.

The automatic programmes require the weight of the food. With individual pieces, always enter the weight of the largest. The total weight must be within the specified weight range.

Cooking time

After the programme is started the cooking time is displayed. It may change during the first 10 minutes, as the heating-up time depends, among other things, on the temperature of the food and the water.

Potatoes

Do not season potatoes until after cooking.

Programme	Note	Accessories	Level
Boiled potatoes*	medium-sized, quartered, 30 - 40 g each	Perforated cooking container + Baking tray	3 1
Unpeeled boiled potatoes*	medium-sized, dia. 4 - 5 cm	Perforated cooking container + Baking tray	3 1

* You can delay the end time for this programme

Cereal products

Weigh the food and add the correct ratio of water:

- Rice 1:1.5
- Couscous 1:1
- Millet 1:3
- Lentils 1:2

Enter the weight excluding liquid.

Stir cereal products after cooking. The remaining water is then quickly absorbed.

Making risotto

Add water to the risotto in the ratio of 1:2. Enter the total weight including water. The message "Stir" appears after approx. 15 minutes. Stir the risotto and, if required, press the Start button.

Programme	Note	Accessories	Level
Rice/Long grain rice	max. 0.75 kg	solid cooking container	2
Rice/Basmati rice	max. 0.75 kg	solid cooking container	2
Rice/Brown rice	max. 0.75 kg	solid cooking container	2
Couscous	max. 0.75 kg	solid cooking container	2
Millet	max. 0.55 kg	solid cooking container	2
Risotto	max. 2 kg	solid cooking container	2
Lentils	max. 0.55 kg	solid cooking container	2

Bakes

Programme	Note	Accessories	Level
Bake, savoury, cooked ingredients*	max. 4 cm deep	Wire rack + ovenproof dish	2
Bake, sweet*	max. 4 cm deep	Wire rack + ovenproof dish	2

* You can delay the end time for this programme

Poultry

Do not place chicken breasts or chicken portions on top of each other in the ovenware. The chicken portions can be marinated beforehand.

Programme	Notes	Accessories	Level
Chicken, fresh	total weight 0.7 - 1.5 kg	wire rack + baking tray	2
Chicken portions, fresh	0.04 - 0.35 kg each	wire rack + baking tray	2
Duck, fresh	total weight 1 - 2 kg	wire rack + baking tray	2
Chicken breast, fresh, steamed	total weight 0.2 - 1.5 kg	Perforated cooking container + baking tray	3 1

Beef

With sirloin, it is recommended that you use a thick piece.

Programme	Note	Accessories	Level
Pot roast, fresh*	1 - 1.5 kg	Baking tray	2
Sirloin, fresh, slow cook/ Sirloin, medium**	total weight 1 - 2 kg	Baking tray	2
Sirloin, fresh, slow cook/ Sirloin, rare**	total weight 1 - 2 kg	Baking tray	2

* You can delay the end time for this programme

** Sear the meat well beforehand

Veal

Programme	Note	Accessories	Level
Joint, fresh/Lean joint*	1 - 2 kg	Wire rack + baking tray	2
Joint, fresh/Marbled joint*	1 - 2 kg	Wire rack + baking tray	2
Breast, stuffed*	1 - 2 kg	Wire rack + baking tray	2

* You can delay the end time for this programme

Pork

Before cooking, score the rind from the middle outwards.

For a joint with a crust, it is best to use a piece of shoulder.

Programme	Note	Accessories	Level
Boned neck joint, fresh*	1 - 2 kg	Wire rack + baking tray	2
Joint with crust, fresh*	0.8 - 2 kg	Wire rack + baking tray	2
Boiled sausages*	-	Perforated cooking container + Baking tray	3 1

* You can delay the end time for this programme

Lamb

Programme	Note	Accessories	Level
Leg, fresh/Boned, well done	1 - 2 kg	Wire rack + baking tray	2
Leg, fresh/ Boned, medium, slow cook*	1 - 2 kg	Baking tray	2

* Ensure that the meat is well sealed beforehand

Meat loaf

Programme	Notes	Accessories	Level
Made from fresh minced meat	total weight 0.5 - 2 kg	baking tray	2

Fish

When preparing fish, grease the perforated cooking container.

Do not place whole fish, fish fillets or fish fingers on top of each other. Enter the weight of the heaviest fish and choose pieces as similar in size as possible.

Programme	Note	Accessories	Level
Steam whole, fresh fish	0.3 - 2 kg	Perforated cooking container + Baking tray	3 1
Steam fish fillet/Fish fillet, fresh	max. 2.5 cm thick	Perforated cooking container + Baking tray	3 1
Steam fish fillet/Fish, frozen	max. 2.5 cm thick	Perforated cooking container + Baking tray	3 1
Blue mussels	-	Perforated cooking container + Baking tray	3 1
Breaded squid rings, frozen	0.5 - 1.25 kg	Baking tray + greaseproof paper	2
Fish fingers	0.5 - 1 kg	Baking tray + greaseproof paper	2

Pastries, dessert

Baking plaited loaf

Leave the yeast dough to prove in the combination steam oven for half an hour at 40 °C.

Making fruit compote

The programme is only suitable for fruits with stones and pips. Weigh the fruit and add approximately 1/3 the amount in water, and add sugar and spices according to taste.

Making rice pudding

Weigh the rice and add 2.5 times the amount of milk. Ensure

the level of rice and milk in the accessory is no higher than 2.5 cm. Stir after cooking. The remaining milk is quickly absorbed.

Making yoghurt

Heat the milk to 90 °C on the hob. Then leave to cool to 40 °C. If you are using UHT milk, you do not need to heat it.

Stir in one to two teaspoons of natural yoghurt per 100 ml milk, or the corresponding amount of yoghurt culture into the milk. Pour the mixture into clean jars and seal them.

After preparation, leave the glasses to cool in the refrigerator.

Programme	Note	Accessories	Level
Plaited loaf	0.6 - 1.8 kg	Baking tray + greaseproof paper	2
Sponge cake	0.8 - 2 kg	Greased springform cake tin with fluted ring base, dia. 26 cm + wire rack	2
Fruit compote*	-	Baking tray	2
Rice pudding	-	Baking tray	2
Yoghurt in glass jars	-	Glass jars + perforated cooking container	2

* You can delay the end time for this programme

Bread/bread rolls

Baking bread

The programmes are for bread baked without a tin. The dough should not be too soft. Cut into the dough several times with a sharp knife to a depth of approx. 1 cm before baking.

Proving and baking dough

The message "Cut into the bread" appears after approx. 20 minutes. Cut into the dough and press the Start button.

Baking fresh bread rolls

The bread rolls should all be the same weight. Enter the weight of an individual bread roll.

Programme	Notes	Accessories	Level
Multigrain bread / Bake*	0,6 - 2 kg	baking tray + greaseproof paper	2
Multigrain bread / prove and bake	Note the message	baking tray + greaseproof paper	2
Rye bread / Bake*	0,6 - 2 kg	baking tray + greaseproof paper	2
Rye bread / prove and bake	Note the message	baking tray + greaseproof paper	2
White bread / Bake*	0,4 - 2 kg	baking tray + greaseproof paper	2
White bread / Prove and bake	Note the message	baking tray + greaseproof paper	2
Bread rolls / Bake fresh bread rolls*	Weight per piece 0,05 - 0,1 kg	baking tray + greaseproof paper	2
Bread rolls / Bake frozen bread rolls	Total weight 0,2 - 1 kg	baking tray + greaseproof paper	2

* You can delay the end time for this programme

Reheat

Programme	Note	Accessories	Level
1 portion*	-	Wire rack	2
2 portions*	-	Wire rack	2
Side dishes, cooked*	-	Baking tray	2
Cooked vegetables*	-	Baking tray	2
Pizza, cooked/Pizza, thin base*	-	Wire rack + baking tray	3
Pizza, cooked/Pizza, deep-pan*	-	Wire rack + baking tray	3

* You can delay the end time for this programme

Defrosting

When freezing, lay the food as flat as possible and in portion-sized pieces at -18 °C. Do not freeze excessively large quantities. Once defrosted, food will not keep for as long and spoils more quickly than fresh food.

Leave the food to defrost in the freezer bag, on a plate or in the perforated cooking container. Always insert the baking tray underneath. The food is then not left lying in the defrost water and the cooking compartment remains clean.

All defrost programmes apply to raw food.

If necessary, the meal can occasionally be split apart or pieces which have already defrosted can be removed from the appliance.

After defrosting, allow the food to stand for a further 5 - 15 minutes to allow the temperatures to even out.

Health risk!

When defrosting food from animal sources, you must remove the liquid that escapes during defrosting. It must never come

into contact with other food. Bacteria could be transferred. After defrosting, operate the combination steam oven for 15 minutes using Hot air at 180 °C.

Defrosting fish fillet

Do not place the fish fillets on top of each other.

Defrosting whole poultry

Remove the packaging before defrosting. Leave the poultry to stand after defrosting. With large poultry (e.g. small turkeys), you can remove the giblets after approximately 30 minutes standing time.

Defrost meat

With this programme you can defrost individual joints of meat.

Only thaw fruit (not defrost)

If you only wish to thaw the fruit slightly, you can make an individual adjustment to the cooking result.

Programme	Note	Accessories	Level
Fish/whole fish	max. 3 cm thick	Perforated cooking container + Baking tray	3 1
Fish/Fish fillet	max. 2.5 cm thick	Perforated cooking container + Baking tray	3 1
Whole poultry	max. 1.5 kg	Perforated cooking container + Baking tray	3 1
Meat	max. weight per piece 1.5 kg	Perforated cooking container + Baking tray	3 1
Berries	-	Perforated cooking container + Baking tray	3 1

Special

Sterilising bottles

Always clean the bottles with a bottle brush immediately after drinking. Then clean them in the dishwasher.

Place the bottles in the perforated cooking container so that they do not touch one another.

Dry the bottles with a clean cloth after sterilising. The process corresponds to normal sterilisation by boiling.

Preserving

This programme is suitable for fruits with a stone and core and for vegetables (except beans).

Blanch pumpkin before preserving.

The programme is designed for 1 litre jars. For larger or smaller jars, you must adjust the cooking result individually.

After the end of the programme, open the appliance door to prevent overcooking in the remaining heat. Leave the jars to cool down for a few minutes in the cooking compartment.

The programme is designed for firm fruit. If the fruit being used is no longer firm, adjust the cooking results individually.

Cooking eggs

Pierce the eggs before cooking. Do not place eggs on top of each other. Size M corresponds to a unit weight of approx. 50 g.

Programme	Note	Accessories	Level
Sterilising bottles*	-	Perforated cooking container	2
Preserving	in 1 litre glass jars	Perforated container + Baking tray	3 1
Eggs/hard-boiled eggs*	Eggs, size M, Max. 1.8 kg	Perforated container + Baking tray	3 1
Eggs/soft-boiled eggs*	Eggs, size M, max. 1 kg	Perforated container + Baking tray	3 1

* You can delay the end time for this programme

Memory

The memory function allows you to save a programme of your own and access it again at the touch of a button. The memory function is useful for dishes you prepare particularly frequently.

Saving to the Memory function

1. Set the heating type, temperature and, if required, a cooking time. Do not start operation.

2. Press and hold the **M** button until "Memory saved" is displayed.

The memory setting is saved.

If you save another setting using the **M** button, the old setting is overwritten.

Starting the memory function

The saved setting can be started at any time.

1. Press the **M** button briefly.

2. Press the Start button.



The memory setting is started.

The setting can be changed at any time. When you start the memory the next time, the original saved setting appears again.

Childproof lock

The appliance has a childproof lock to prevent children switching it on accidentally or changing a setting.



Activating the childproof lock

Press and hold the  button for approx. 4 seconds until the  symbol appears.

The control panel is locked.

Even with the childproof lock activated, you can switch the appliance off, cancel the signal using the  button, stop operation using the Stop button and set the timer.

Deactivating the childproof lock

Press and hold the  button until the  symbol disappears. You can make settings again.

Basic settings

Your appliance has various basic settings, which are preset at the factory. You can change the basic settings as you require.

If you want to cancel all the changes, you can restore the factory settings.

The appliance must be switched off.

1. Switch off the appliance.
2. Press and hold the **i** button for approx. 4 seconds until "Select language" appears on the display.
3. Press the **>** button until the desired basic setting appears.
4. Turn the rotary selector to change the setting.
5. Press and hold the **i** button for approx. 4 seconds to exit Basic settings.
The change is saved.

You can change the following basic settings:

Basic setting	Function	Possible settings
Select language	Changes the display language	30 different languages
Signal duration	Sets the length of the audible signal at the end of an operation	short / medium / long
Button tone	Switches on or off the audible signal that sounds when you press a button	off / on
Display brightness	Changes display brightness	day / medium / night
Clock display	Displays the clock when the appliance is off	off / analogue 1 / analogue 2 / analogue 3 / digital
Continue after door closed	Not necessary to restart after the door has been opened	off / automatic
Adjust individually	Sets programme cooking results to be generally higher or lower	7 levels -  +
Display brand logo	Switches the brand name logo display on or off when the appliance is switched on	on / off
Water hardness	Sets the water hardness range for the descaling indicator	softened / 1-soft / 2-medium / 3-hard / 4-very hard
Steam cooking heat signal:	Audible signal at the end of the heating up phase during steaming	off / on
Restore factory settings	Restores the appliance to the factory settings: <ul style="list-style-type: none">■ All changes to the basic settings are cleared■ Memory is cleared■ Automatic calibration is carried out again	do not restore / restore

Automatic switch-off

If you do not change the settings on your appliance for several hours, the automatic switch-off function will be activated.

"Automatic switch-off" appears in the display.

Press any button to deactivate the automatic switch-off. You can now make new settings.

Care and cleaning

In this section, you will find information on

- care and cleaning of your appliance
- the cleaning aid
- descaling

Risk of short circuit!

Do not use high-pressure cleaners or steam jet cleaners to clean your appliance.

Caution!

Risk of surface damage: Do not use

- harsh or abrasive cleaning agents
- oven cleaners
- corrosive or aggressive cleaners, or those containing chlorine
- cleaning agents with a high alcohol content

If such an agent comes into contact with the front of the appliance, wash it off immediately with water.

Caution!

Risk of surface damage: If descaler or the oven and grill cleaning gel comes into contact with the front of the appliance or other sensitive surfaces, wash it off immediately with water.

Remove food residues from the cooking compartment as soon as the appliance has cooled. Burnt-on remains will be much harder to remove later.

For heavy soiling use the cleaning aid (see section: Cleaning aid).

Salts are very corrosive and can cause rust. Remove remains of acidic sauces (ketchup, mustard) or salted food from the cooking compartment immediately after cooling.

Do not use hard scouring pads or cleaning sponges.

Cleaning agents

Appliance exterior (with aluminium front)	Use soapy water and dry with a soft cloth. Mild window cleaning agent - wipe the aluminium front horizontally and without applying pressure using a soft window cloth or a lint-free microfibre cloth.
Appliance exterior (with stainless steel front)	Use soapy water and dry with a soft cloth. Always remove flecks of limescale, grease, starch and albumin (e.g. egg white) immediately. Special stainless steel cleaning agents can be obtained from the after-sales service or from specialist retailers.
Cooking compartment interior with evaporator dish	Hot, soapy water or a vinegar solution - use the enclosed cleaning sponge or a soft washing-up brush. Caution! The cooking compartment could rust.: Do not use steel pads or scourers. If the cooking compartment contains heavy deposits of dirt, use only the oven and grill cleaning gel recommended by the after-sales service (ordering no. 463 582, also available online in the eShop). Follow the manufacturer's instructions. Other oven cleaners could damage the appliance. The cooking compartment light and the seals around the door, light and evaporator dish must not come into contact with the gel. Allow the gel to act for at least 12 hours and do not switch on the appliance during this time. Then rinse out the cooking compartment thoroughly with water (e.g. with a spray bottle) to remove all gel residues.
Grease filter	Remove the grease filter on the back wall of the cooking compartment by lifting it off upwards and clean it with hot soapy water or in the dishwasher. Clean the grease filter every time heavy dirt deposits have been left behind after cooking.  Risk of injury! You could hurt yourself on the grease filter hooks. Always clean the grease filter with care. Always place the grease filter in the dishwasher so that the hooks for fixing it in place are facing downwards.
Water tank	Soapy water - do not clean in the dishwasher.
Water tank recess	Rub dry after every use
Seal in the water tank lid	Thoroughly dry after every use
Rails	See section: Cleaning the rails
Door panels	See section: Cleaning the door panels Caution! Surface damage: After cleaning, wipe the door panels with glass cleaner, then dry. Otherwise, stains will appear which it will not be possible to remove.
Door seal	Hot soapy water
Accessories	Soak in hot soapy water. Clean with a washing-up brush or sponge or in the dishwasher. Clean stains caused by starchy food (e.g. rice) with a vinegar solution

Cleaning sponge

The enclosed cleaning sponge is very absorbent. Use the cleaning sponge only for cleaning the cooking compartment and for removing residual water from the evaporator dish.

Wash the cleaning sponge thoroughly before using for the first time. You can wash the cleaning sponge in the washing machine (hot wash).

Microfibre cloth

The honeycomb microfibre cloth is particularly suitable for cleaning sensitive surfaces such as glass, glass ceramic, stainless steel or aluminium (product no. 460 770, also available from our online eShop). It removes liquid and greasy deposits in one go.

Roasting set

If possible use the roasting set when roasting (ordering no. HEZ36DB, also available online in the eShop). This considerably reduces the amount of spatter from the roast and therefore the amount of soiling in the cooking compartment.

Cleaning aid

The cleaning aid loosens dirt in the cooking compartment using steam. It can then be removed easily.

The cleaning process consists of:

- Cleaning (approx. 30 minutes), then empty the evaporator dish and wipe out the appliance
- 1st rinse (20 seconds), then empty the evaporator dish
- 2nd rinse (20 seconds), then remove the remaining water

All three steps must be completed in full. The appliance is ready for operation again only after the 2nd rinse.

Preparation

Allow the cooking compartment to cool down and remove the accessories. Clean the evaporator dish with the enclosed cleaning sponge.

Put a drop of washing-up liquid into the evaporator dish on the cooking compartment floor.

Starting the cleaning aid

1. Press the  button to switch on the appliance.
2. Press the **clean** button.
"Clean" appears in the display.
3. Fill the water tank with water up to the "max" mark and slide it in.
4. Press the Start button.
The cleaning aid starts running. The light in the cooking compartment remains switched off.

Emptying the evaporator dish and wiping out the appliance

A signal sounds after approx. 30 minutes. "Empty dish and wipe out appliance" and " 0:40" appear in the display.

1. Open the appliance door.
"Appliance ready to rinse" appears in the display.
2. Take the rails out of the cooking compartment and clean them (see section: Cleaning the rails).
3. Wipe out all loosened food residues from the cooking compartment and the evaporator dish using a soft washing-up brush and the cleaning sponge.
4. If required, fill the water tank with water and reinsert it.
5. Close the appliance door.
"Continue operation with 'Start'" appears in the display.

1st rinse

Press the Start button.
The appliance starts rinsing. "1st rinse" and the cooking time  appear in the display.

Empty evaporator dish

After 20 seconds, "Empty dish" and " 0:20" appear in the display.



1. Open the appliance door.
"Appliance ready to rinse" appears in the display.
2. Thoroughly rinse out the cleaning sponge.
3. Remove the remaining water from the evaporator dish using the cleaning sponge.
4. Close the appliance door.
"Continue operation with 'Start'" appears in the display.

2nd rinse

Press the Start button.
The appliance starts rinsing. "2nd rinse" and the cooking time  appear in the display.

Removing the remaining water

After 20 seconds, "Empty dish" appears in the display.

1. Open the appliance door.
"End" and " 0:00" appear in the display.
2. Remove the remaining water from the evaporator dish using the cleaning sponge.
3. Wipe out the cooking compartment using the cleaning sponge and then dry with a soft cloth.
4. Press the  button to switch off the appliance.

The cleaning aid is complete.

Cancelling the cleaning aid

Note: After cancelling the cleaning aid, the appliance must be rinsed twice. The appliance is locked against other applications until the second rinsing operation is complete.

1. Press the Stop button to cancel the Cleaning aid.
"Continue operation with 'Start'" and "Clean" appear on the display.
To ensure that no washing-up liquid remains in the appliance, it must be rinsed twice after a cancellation.
2. Press the Start button.
"Empty dish and wipe out appliance" appears in the display.
3. If required, fill the water tank with water, reinsert it and press the Start button.

Now proceed as described in the section "Emptying the evaporator dish and wiping out the appliance".

Descaling

The appliance must be descaled at regular intervals in order for it to continue operating correctly. "Descal the appliance" reminds you of this.

You can only dispense with descaling completely if you exclusively use softened water.

The descaling consists of:

- Descal (approx. 30 minutes), then empty the evaporator dish and refill the water tank
- 1st rinse (20 seconds), then empty the evaporator dish
- 2nd rinse (20 seconds), then remove the remaining water

All three steps must be completed in full. The appliance is ready for operation again only after the 2nd rinse.

Descaler

Only use the liquid descaler recommended by the after-sales service for descaling (product no. 311 138, also available online from the eShop). Other descalers may damage the appliance.

1. Prepare a descaling solution by mixing 300 ml water and 60 ml liquid descaler.
2. Empty the water tank and fill with descaling solution.

Caution!

Risk of surface damage: If descaler comes into contact with the front of the appliance or any other sensitive surfaces, wash it off immediately with water.

Starting descaling

The cooking compartment must have cooled down completely.

1. Press the  button to switch on the appliance.
2. Press the **clean** button.
"Clean" appears in the display.
3. Turn the rotary selector until "Descale" appears.
4. Slide in the water tank containing the descaling solution and close the appliance door.
5. Press the Start button.
The descaling process starts. The light in the cooking compartment remains switched off.

Emptying the evaporator dish and refilling the water tank

A signal sounds after approx. 30 minutes. "Empty dish and refill water tank" and "I→I 0:40" appear in the display.

1. Open the appliance door.
2. Remove the descaling solution from the evaporator dish using the cleaning sponge supplied.
3. Rinse the water tank thoroughly, fill with water and reinsert.
"Appliance ready to rinse" appears in the display.
4. Close the appliance door.
"Continue operation with 'Start'" appears in the display.

1st rinse

Press the Start button.
The appliance starts rinsing. "1st rinse" and the cooking time I→I appear in the display.

Empty evaporator dish

After 20 seconds, "Empty dish" and "I→I 0:20" appear in the display.

1. Open the appliance door.
"Appliance ready to rinse" appears in the display.
2. Thoroughly rinse out the cleaning sponge.
3. Remove the remaining water from the evaporator dish using the cleaning sponge.
4. Close the appliance door.
"Continue operation with 'Start'" appears in the display.

2nd rinse

Press the Start button.
The appliance starts rinsing. "2nd rinse" and the cooking time I→I appear in the display.

Removing the remaining water

After 20 seconds, "Empty dish" appears in the display.

1. Open the appliance door.
"End" and "I→I 0:00" appear in the display.
2. Remove the remaining water from the evaporator dish using the cleaning sponge.
3. Wipe out the cooking compartment using the cleaning sponge and then dry with a soft cloth.
4. Press the  button to switch off the appliance.
Descaling is complete.

Cancelling the descaling

Note: After cancelling the descaling, you must rinse the appliance twice. The appliance is locked against other applications until the second rinsing operation is complete.

1. Press the Stop button to cancel the descaling process.
"Continue operation with 'Start'" and "Descale" appear in the display.
To ensure that no descaling solution remains in the appliance, it must be rinsed twice after a cancellation.
 2. Press the Start button.
"Empty dish and refill water tank" appears in the display.
- Now proceed as described in the "Emptying the evaporator dish and refilling the water tank" section.

Descaling the evaporator dish only

You can also use "Descale" if you do not wish to descale the whole appliance, but only the evaporator dish in the cooking compartment.

The only difference is as follows:

1. Prepare a descaling solution by mixing 100 ml water and 20 ml liquid descaler.
2. Completely fill the evaporator dish with descaling solution.
3. Fill the water tank with water only.
4. Start "Descale" as described.

You can also descale the evaporator dish manually.

Removing and fitting the appliance door

You can remove the appliance door to clean it more thoroughly.

Risk of injury!

The hinges of the appliance door may snap shut with great force. Always open the hinge locking lever fully when removing the appliance door and close it fully after refitting. Do not reach into the hinge.

Risk of injury!

If the appliance door has only been unhinged on one side, do not reach into the hinge. The hinge can snap back with great force. Call the after-sales service.

Removing the appliance door

1. Open the appliance door fully.
2. Fold out the locking levers on the left and right fully (figure A).
The hinges are secured and cannot snap closed.
3. Close the appliance door until you feel some resistance.
4. With both hands, grip the door on the left and right-hand side, close the door a little more and pull it out (Fig. B).

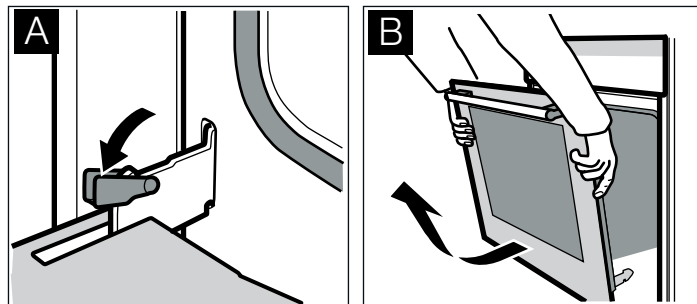

Fitting the appliance door

Refit the appliance door after cleaning.

1. Insert the hinges in the left and right-hand bracket (figure C).
The notch on both hinges must engage.
2. Open the appliance door fully.

- Close the locking levers on the left and right-hand side fully (figure D).

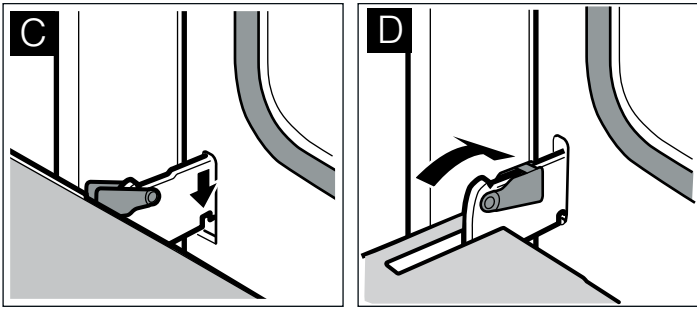

The appliance door is secured and can no longer be removed.

- Close the appliance door.

Cleaning the door panels

To facilitate cleaning, you can remove the door panels from the appliance door.

⚠ Risk of injury!

The components inside the appliance door may have sharp edges. Take care not to cut yourself. Wear protective gloves.

⚠ Risk of injury!

The appliance must not be used again until the door panels and appliance door have been correctly fitted.

Removing the door panel

Note: Before removing, make a note of the orientation in which the door panel is fitted, so that it is not refitted the wrong way round.

- Unhook the appliance door and lay it on a soft, clean surface with the front side facing downwards (see section: Removing and installing the appliance door).
- Unscrew the cover at the top left and right of the appliance door and detach it (figure A).
- Lift the door panel and remove it (figure B).

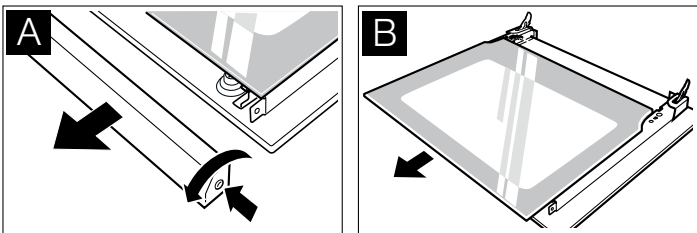

Removing the intermediate panel

Before removing, make a note of the position in which the intermediate panel is fitted, so that you do not refit it the wrong way round later.

- Press the left and right-hand holders outwards.
- Lift the intermediate panel slightly and take it out.

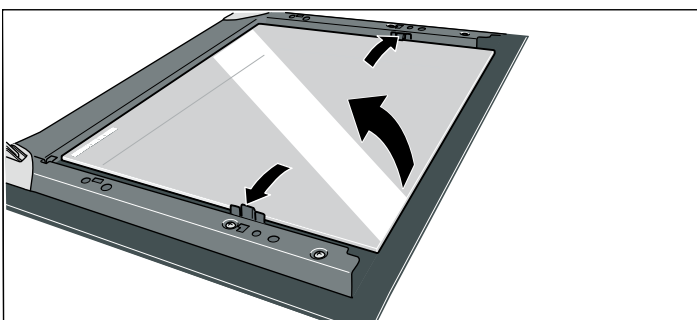

Cleaning

Clean the door panels with glass cleaner and a soft cloth.

Caution!

Do not use any sharp or abrasive medium or a glass scraper. The glass could be damaged.

Fitting the intermediate panel

- Insert the intermediate panel on the left and right into the supports.
- Push the intermediate panel downwards in the retainers.

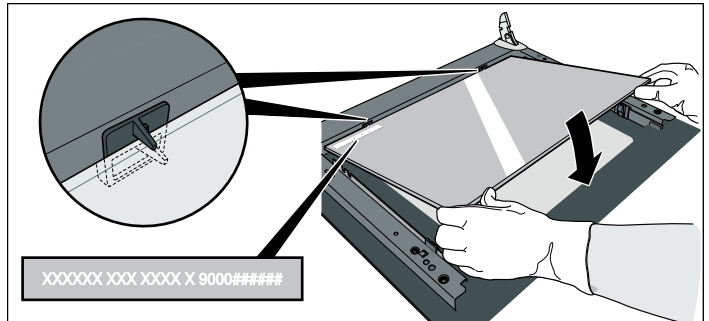

Fitting the door panel

- Slide in the door panel all the way.
- Put the cover back in place and screw it in.
- Refit the appliance door.

Cleaning the rails

The rails can be removed for cleaning.

⚠ Risk of burning due to hot components in the cooking compartment!

Wait until the cooking compartment has cooled down.

Detaching the rails

Note: Swing the front of the rail as far as possible (until you feel resistance), because otherwise the appliance side panel may become bent.

- Carefully press the front of the rail upwards until it becomes detached, and release it from the holder at the side (fig. A).
- Detach the rail from the holder and remove it (fig. B).

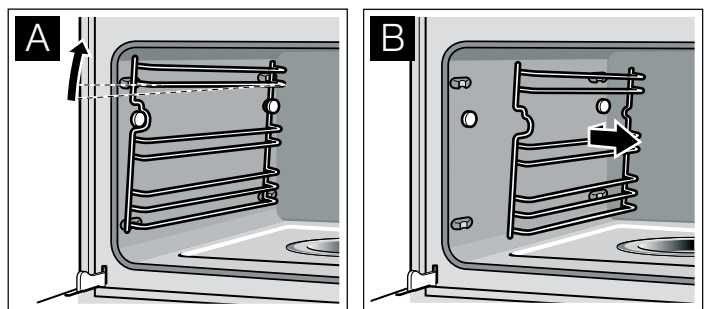

- Clean the rails with washing-up liquid and a sponge/brush or Clean the rails in the dishwasher.

Attaching the rail

1. Position the rail so that the indentations are facing upwards.
2. Hook the rail in at the back and push it towards the rear until it engages (fig. C).
3. Hook the front of the rail onto the holder and press down until it engages and is fixed level in place in the appliance once more (fig. D).

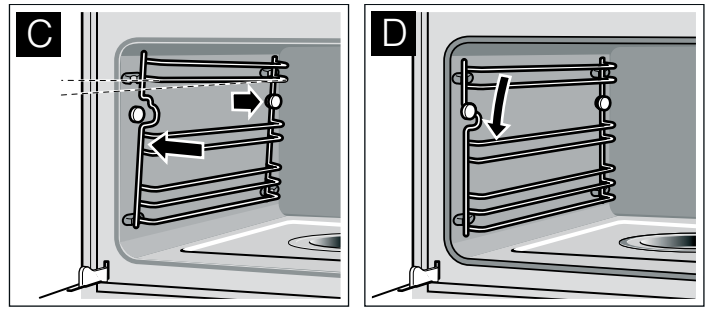

Each set of rails only fits on one side.

Troubleshooting

Malfunctions often have simple explanations. Please read the following instructions before calling the after-sales service.

Repairs may only be carried out by fully trained after-sales service technicians. Incorrect repairs to your appliance may present considerable risks for the user.

Risk of electric shock!

- Work on the appliance electronics may only be performed by a specialist.
- Always disconnect the appliance from the power supply when work is carried out on the electronics. Switch off the circuit breaker or remove the fuse from your household fuse box.

Problem	Possible cause	Notes/remedy
The appliance does not work	The plug is not plugged into the mains.	Connect the appliance to the electricity supply
	Power cut	Check whether other kitchen appliances are working
	Fuse defective	Check in the fuse box to make sure that the fuse for the appliance is OK
	Faulty operation	Switch the appliance off using the fuse in the fuse box. Wait approximately 10 seconds and then switch it back on.
The appliance cannot be started	The appliance door is not fully closed	Close the appliance door.
The appliance cannot be started, the display shows "Continue operation with 'Start'" "Descale"	Descaling has been cancelled	Press the Start button. Then rinse the appliance twice (see section: Descaling. Proceed as described under "Emptying the evaporator dish and refilling the water tank")
The appliance cannot be started, the display shows "Continue operation with 'Start'" "Clean"	The cleaning aid has been cancelled	Press the Start button. Then rinse the appliance twice (see section: Cleaning aid. Proceed as described under "Emptying the evaporator dish and wiping out the appliance")
"Clock" appears in the display	Power cut	Reset the clock (see section: Time-setting options)
The appliance is not in operation. A cooking time is shown in the display.	The rotary selector was accidentally operated	Press the Stop button
	The Start button was not pressed after the setting had been made.	Press the Start button or delete the setting with the Stop button
"Automatic switch-off" appears in the display	The Automatic switch-off is active.	Press any button.
"Fill water tank" appears even though the water tank is full	The water tank has not been pushed in properly	Slide in the water tank until it engages
	The detection system is not working	Call the after-sales service
"Fill water tank" appears even though the water tank is not yet empty, or "Fill water tank" does not appear even though the water tank is empty	The water tank is dirty. The mobile water level indicators are jammed	Shake and clean the water tank. If the parts cannot be released, obtain a new water tank from the after-sales service.
The water tank empties for no discernible reason. The evaporator dish is overflowing	The water tank was not closed properly	Close the lid until you feel it engage.
	The tank lid seal is dirty	Clean the seal
	The seal in the tank cover is defective	Obtain a new water tank from the after-sales service

Problem	Possible cause	Notes/remedy
Liquid in the evaporator dish has fully evaporated, even though the water tank is full.	The water tank has not been pushed in properly	Slide in the water tank until it engages
	The feed line is blocked	Descale the appliance. Check whether the water hardness range is set correctly
"Empty tank/clean?" appears in the display	The appliance has not been used for at least two days and the water tank is full	Empty and clean the water tank. Always empty the water tank after cooking
There is a "pop" noise during cooking	Cold/warm effect with frozen food, caused by the steam.	This is normal
When you cook with steam, a lot of steam is created	The appliance is being automatically calibrated	This is normal
When cooking with steam, a lot of steam is produced repeatedly	The appliance is unable to calibrate itself automatically if cooking times are too short	Restore the appliance to the factory setting (see section: Basic settings). Then start steaming at 100 °C for 20 minutes
Steam escapes from the ventilation slots during cooking		This is normal
The appliance is not producing steam properly	Limescale has formed in the appliance	Start the descaling programme.
Error message "E011" appears in the display	A button was pressed for too long or is jammed	Press the ⏻ button to delete the error message Press all of the buttons individually and check whether they are clean
An error message "E..." appears in the display	Technical fault.	Press the ⏻ button to delete the error message. Reset the clock if required. If the error message appears again, call the after-sales service
The appliance is not heating. "Demo" is shown in the display	A button combination was actuated	Disconnect the power supply and reconnect after 10 seconds. Within 2 minutes, press the ↵ button for 4 seconds

Replacing the cooking compartment bulb

Heat-resistant 230 V/25 W halogen bulbs with seals are available from the after-sales service. Please specify the E number and FD number of your appliance.

⚠ Risk of burns!

Allow the cooking compartment and cooking compartment light to cool before changing the bulb.

Always use a dry cloth to remove a new halogen bulb from the packaging, otherwise it will not last as long.

1. Switch off the fuse in the fuse box or unplug at the mains.
2. Turn the cover anti-clockwise to remove.
3. Remove the bulb and replace with a bulb of the same type.
4. Slide the new seals and the clamping ring onto the glass cover in the right order.

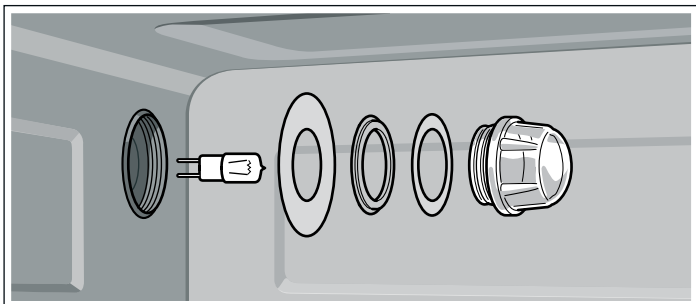

5. Screw the glass cover with the seals back on again.
 6. Connect the appliance to the mains and reset the clock.
- Never operate the appliance without the glass cover and seals.

Replacing the glass cover or seals

Any damaged glass cover or seals must be replaced. Please provide the after-sales service with the E number and FD number of your appliance.

Changing the door seal

If the seal around the outside of the cooking compartment is faulty, it must be replaced. Replacement seals for your appliance can be obtained from the after-sales service. Please specify the E number and FD number of your appliance.

1. Open the appliance door.
2. Pull off the old seal.
3. Push in the new door seal at one point and pull it in all the way round. The joint must be at the side.
4. Check again that the seal is correctly fitted in the corners.

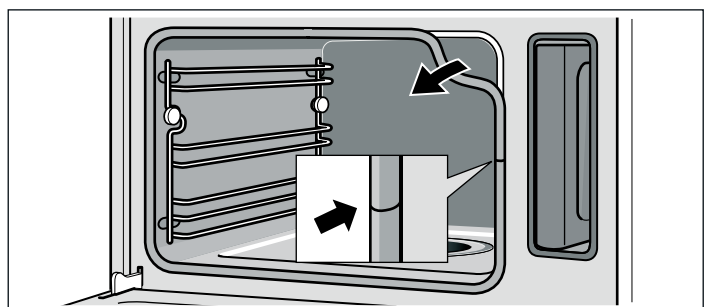

After-sales service

Our after-sales service is there for you if your appliance needs to be repaired. We will always find the right solution in order to avoid unnecessary visits from a service technician.

E number and FD number

When calling us, please give the product number (E no.) and the production number (FD no.) so that we can provide you with the correct advice. The rating plate bearing these numbers can be found on the lower left-hand side when you open the appliance door.

You can make a note of the numbers of your appliance and the telephone number of the after-sales service in the space below to save time should it be required.

E no.	FD no.

After-sales service

Please note that there will be a fee for a visit by a service technician in the event of a malfunction, even during the warranty period.

Please find the contact data of all countries in the enclosed customer service list.

To book an engineer visit and product advice

GB 0844 8928999

Calls from a BT landline will be charged at up to 3 pence per minute. A call set-up fee of up to 6 pence may apply.

IE 01450 2655

Trust the expertise of the manufacturer, and rest assured that the repair will be carried out by trained service technicians using original spare parts for your domestic appliance.

Environmental protection

Unpack the appliance and dispose of the packaging in an environmentally-responsible manner.

Environmental protection



This appliance is labelled in accordance with the European Directive 2002/96/EU concerning used electrical and electronic appliances (WEEE – waste electrical and electronic equipment). The guideline determines the framework for the return and recycling of used appliances as applicable.

Tips for saving energy

- Only preheat the appliance if this is specified in the recipe or in the operating instructions table.
- Open the appliance door as infrequently as possible while the food is cooking.
- Use dark, black lacquered or enamelled baking tins for baking. They absorb the heat particularly well.
- It is best to bake several cakes one after the other. The combination steam oven will still be hot. This reduces the baking time for the second cake. You can also place two loaf tins next to each other.
- If the cooking time is relatively long, you can switch off the combination steam oven 10 minutes before the end of the cooking time and use the oven's residual heat to complete the cooking process.
- When steaming, you can cook on several levels at the same time. When preparing foods with different cooking times, those with the longest cooking time should be placed in the oven first.

Tables and tips

The tables contain a selection of dishes which are particularly suitable for your combination steam oven. You can find out which operating mode, accessories and cooking time to select. Unless otherwise stated, the information given applies to inserting accessories when the appliance is cold.

Accessories

Use the accessories provided.

When steaming in the perforated cooking container, always insert the baking tray underneath. Dripping liquid is caught.

Ovenware

When using ovenware, always place it in the middle of the wire rack.

Ovenware must be heat and steam resistant. Cooking times are increased if thick-sided ovenware is used.

Food which would normally be prepared in a bain-marie should always be covered with foil (e.g. when melting chocolate).

Steam

Steaming is a particularly gentle way of cooking food. The steam surrounds the dish thereby preventing a loss of nutrients from the food. Cooking takes place without excess pressure. As a result, the shape, colour and typical aroma of the dishes are retained.

Cooking times and quantities

The cooking times when steaming depend on the item size, but do not depend on the total quantity. The appliance can steam food to a maximum of 2 kg.

Follow the unit sizes given in the tables. The cooking time is reduced for smaller pieces and increased for larger ones. Cooking time is also influenced by the quality and ripeness of the food. The values quoted can therefore only serve as a guideline.

Distributing food evenly

Always distribute the food evenly in the ovenware. It will not cook evenly if the layers are of different depths.

Pressure-sensitive food

When layering delicate foods in the cooking container, do not pile them too high. It is better to use two containers.

Cooking a menu

With steam, you can cook a whole menu at once, without the different flavours mixing. Place the food with the longest cooking time in the appliance first and delay the rest until the appropriate time. This means that all the food will be ready at the same time.

The overall cooking time is extended with menu cooking, as a little steam escapes each time the appliance door is opened and has to be reheated.

Vegetables

Place the vegetables in the perforated cooking container and insert at level 3. Insert the baking tray underneath at level 1.

Dripping liquid is caught.

Food	Size	Accessories	Operating mode	Temperature in °C	Cooking time in min.
Artichokes	whole	perforated + baking tray	Steam	100	30 - 35
Cauliflower	whole	perforated + baking tray	Steam	100	30 - 40
Cauliflower	florets	perforated + baking tray	Steam	100	10 - 15
Broccoli	florets	perforated + baking tray	Steam	100	8 - 10
Peas	-	perforated + baking tray	Steam	100	5 - 10
Fennel	slices	perforated + baking tray	Steam	100	10 - 14
Stuffed vegetables (courgettes, aubergines, peppers)	Do not pre-cook vegetables	baking tray at level 2	Hot air + Steam	160 - 180	15 - 30
Vegetable flan	-	1.5 l bain-marie + wire rack at level 2	Steam	100	50 - 70
Green beans	-	perforated + baking tray	Steam	100	15 - 20
Carrots	slices	perforated + baking tray	Steam	100	10 - 20
Kohlrabi	slices	perforated + baking tray	Steam	100	15 - 20
Leeks	slices	perforated + baking tray	Steam	100	4 - 6
Sweetcorn	whole	perforated + baking tray	Steam	100	25 - 35
Swiss chard*	shredded	perforated + baking tray	Steam	100	8 - 10
Green asparagus*	whole	perforated + baking tray	Steam	100	7 - 12
White asparagus*	whole	perforated + baking tray	Steam	100	10 - 15
Spinach*	-	perforated + baking tray	Steam	100	2 - 3
Romanesco	florets	perforated + baking tray	Steam	100	8 - 10
Brussels sprouts	florets	perforated + baking tray	Steam	100	20 - 30
Beetroot	whole	perforated + baking tray	Steam	100	40 - 50

* Preheat the appliance

Hot air

The Hot Air operating mode is ideal for sweet and savoury baking, pot roasts and various cakes.

Hot air + Steam

The Hot air + Steam operating mode is particularly suited to the preparation of roasted joints, chicken and baked items, such as yeast-risen pastry and bread.

Roasts and chicken are nice and crisp on the outside and juicy inside. What is more, meat loses less of its weight.

Baked items, such as yeast-risen pastry and bread, take on a particularly attractive surface shine and they do not dry out.

Food	Size	Accessories	Operating mode	Temperature in °C	Cooking time in min.
Red cabbage	shredded	perforated + baking tray	Steam	100	30 - 35
White cabbage	shredded	perforated + baking tray	Steam	100	25 - 35
Courgettes	slices	perforated + baking tray	Steam	100	2 - 3
Mangetout	-	perforated + baking tray	Steam	100	8 - 12

* Preheat the appliance

Side dishes and pulses

Add water or liquid in the proportion specified.
Example: 1:1.5 = add 150 ml liquid for every 100 g rice.

You may select any shelf position you wish for the solid cooking container.

Food	Ratio	Accessories	Level	Mode of operation	Temperature in °C	Duration in min.
Unpeeled boiled potatoes (Medium size)	-	Perforated + baking tray	3 1	Steam	100	35 - 45
Boiled potatoes (Quartered)	-	Perforated + baking tray	3 1	Steam	100	20 - 25
Potato gratin	-	Baking tray	2	Heißluft	170 - 180	35 - 45
Brown rice	1:1,5	Solid	-	Steam	100	30 - 40
Long grain rice	1:1,5	Solid	-	Steam	100	20 - 30
Basmati rice	1:1,5	Solid	-	Steam	100	20 - 30
Parboiled rice	1:1,5	Solid	-	Steam	100	15 - 20
Risotto	1:2	Solid	-	Steam	100	30 - 35
Lentils	1:2	Solid	-	Steam	100	30 - 45
Canellini beans, pre-softened	1:2	Solid	-	Steam	100	65 - 75
Couscous	1:1	Solid	-	Steam	100	6 - 10
Unripe spelt grain, coarse ground	1:2,5	Solid	-	Steam	100	15 - 20
Millet, whole	1:2,5	Solid	-	Steam	100	25 - 35
Wheat, whole	1:1	Solid	-	Steam	100	60 - 70
Dumplings	-	Perforated + baking tray	3 1	Steam	95	20 - 25

Poultry and meat

Insert the wire rack and baking tray together at the same level.

When the roast is cooked, switch off the combination steam oven and leave it to rest for a further 10 minutes with the door closed. This will keep the meat juicy.

Cooking with the Hot air + Steam operating mode leaves the meat especially juicy on the inside and crispy on the outside.

Poultry

Food	Amount	Accessories	Level	Operating mode	Temperature in °C	Cooking time in min.
Chicken, whole	1.2 kg	wire rack + baking tray	2	Hot air + Steam	180 - 190	50 - 60
Chicken, halved	per 0.4 kg	wire rack + baking tray	2	Hot air + Steam	180 - 190	35 - 45
Chicken breast	0.15 kg each	perforated + baking tray	3 1	Steam	100	15 - 25
Chicken portions	0.12 kg each	wire rack + baking tray	2	Hot air + Steam	180 - 200	20 - 35
Duck, whole	2 kg	wire rack + baking tray	2	Hot air + Steam	170	60 - 80
				Hot air	210	15 - 20
Duck breast*	0.35 kg each	wire rack + baking tray	2	Hot air + Steam	170 - 180	10 - 15

* Sear first

Food	Amount	Accessories	Level	Operating mode	Temperature in °C	Cooking time in min.
Rolled turkey joint	1.5 kg	wire rack + baking tray	2	Hot air + Steam	150 - 160	70 - 90
Turkey breast	1 kg	wire rack + baking tray	2	Hot air + Steam	150 - 160	60 - 80

* Sear first

Beef

Food	Amount	Accessories	Level	Operating mode	Temperature in °C	Cooking time in min.
Pot-roasted beef*	1.5 kg	wire rack + baking tray	2	Reheat	140 - 150	100 - 140
Fillet of beef, medium*	1 kg	wire rack + baking tray	2	Reheat	170 - 180	20 - 28
Thin slice of sirloin, medium*	1 kg	wire rack + baking tray	2	Hot air	170 - 180	40 - 55
Thin slice of sirloin, rare*	1 kg	wire rack + baking tray	2	Hot air	170 - 180	30 - 45
Thick piece of sirloin, medium*	1 kg	wire rack + baking tray	2	Hot air	170 - 180	45 - 60
Thick piece of sirloin, rare*	1 kg	wire rack + baking tray	2	Hot air	170 - 180	35 - 50

* Sear first

Veal

Food	Amount	Accessories	Level	Operating mode	Temperature in °C	Cooking time in min.
Joint of veal, marbled	1 kg	wire rack + baking tray	2	Hot air + Steam	160 - 170	60 - 70
Joint of veal, lean	1 kg	wire rack + baking tray	2	Hot air + Steam	160 - 170	50 - 60
Veal back*	1 kg	wire rack + baking tray	2	Hot air + Steam	160 - 180	15 - 25
Breast of veal, stuffed	1.5 kg	wire rack + baking tray	2	Hot air + Steam	140 - 160	75 - 120

* Sear first

Pork

Food	Amount	Accessories	Level	Operating mode	Temperature in °C	Cooking time in min.
Joint without rind (e.g. neck)	1.5 kg	wire rack + baking tray	2	Hot air + Steam	170 - 180	70 - 80
Joint with rind (crackling)	1.5 kg	wire rack + baking tray	2	Steam	100	20 - 25
				Hot air + Steam	140 - 160	40 - 50
				Hot air	210 - 220	20
Fillet of pork*	0.5 kg	wire rack + baking tray	2	Hot air + Steam	160 - 180	20 - 30
Fillet in puff pastry	1 kg	baking tray	2	Hot air + Steam	180 - 200	40 - 60
Smoked pork on the bone	1 kg	wire rack + baking tray	2	Hot air + Steam	120 - 140	60 - 70
Smoked pork ribs	sliced	baking tray	2	Steam	100	15 - 20
Rolled roasting joint	1.5 kg	wire rack + baking tray	2	Hot air + Steam	170 - 180	70 - 80

* Sear first

Miscellaneous

Food	Amount	Accessories	Level	Operating mode	Temperature in °C	Cooking time in min.
Meat loaf	made from 0.5 kg minced meat	baking tray	2	Hot air + Steam	140 - 150	45 - 60
Saddle of venison on the bone*	0.6 - 0.8 kg	wire rack + baking tray	2	Hot air + Steam	150 - 170	15 - 30
Boned leg of lamb	1.5 kg	wire rack + baking tray	2	Hot air + Steam	170 - 180	60 - 80

* Sear first

Food	Amount	Accessories	Level	Operating mode	Temperature in °C	Cooking time in min.
Saddle of lamb on the bone*	1.5 kg	wire rack + baking tray	2	Hot air + Steam	160 - 170	15 - 25
Rabbit portions	1.5 kg	wire rack + baking tray	2	Hot air + Steam	150 - 160	40 - 60
Wiener sausages	-	perforated + baking tray	3 1	Steam	80 - 85	12 - 18
Bavarian veal sausages	-	perforated + baking tray	3 1	Steam	80 - 85	15 - 20

* Sear first

Roasting tips

Using the roasting set	Using the roasting set will give optimum results and the cooking compartment will stay as clean as possible. You can purchase the roasting set as an accessory from specialist retailers (see section: Accessories)
When is the roast ready?	Use a meat thermometer (available from specialist retailers) or carry out the "spoon test": press down on the roast with a spoon. If it feels firm, it is ready. If the spoon can be pressed in, it needs to be cooked for a little longer.
The roast is too dark and the outside is burnt in places.	Check the shelf height and temperature.
The roast looks good but the juices are burnt.	Next time, choose a smaller roasting dish or add more liquid.
The roast looks good, but the juices are too clear and watery.	Next time, choose a larger roasting dish or add less liquid.

Fish

Food	Amount	Accessories	Level	Type of heating	Temperature in °C	Cooking time in min.
Sea bream, whole	per 0.3 kg	perforated + baking tray	3 1	Steam	80 - 90	15 - 25
Sea bream fillet	per 0.15 kg	perforated + baking tray	3 1	Steam	80 - 90	10 - 20
Fish terrine	Bain marie 1.5 l	wire rack	2	Steam	70 - 80	40 - 80
Trout, whole	per 0.2 kg	perforated + baking tray	3 1	Steam	80 - 90	12 - 15
Cod fillet	per 0.15 kg	perforated + baking tray	3 1	Steam	80 - 90	10 - 14
Salmon fillet	per 0.15 kg	perforated + baking tray	3 1	Steam	100	8 - 10
Mussels	1.5 kg	baking tray	2	Steam	100	10 - 15
Ocean perch fillet	per 0.15 kg	perforated + baking tray	3 1	Steam	80 - 90	10 - 20
Sole rolls, stuffed	-	perforated + baking tray	3 1	Steam	80 - 90	10 - 20

Slow cooking meat

Slow cooking is the ideal cooking method for all tender pieces of meat which are to be cooked medium rare or à point. The meat remains very juicy and turns out as soft as butter.

Slide the baking tray into the combination steam oven and preheat with the Slow cook operating mode.

Sear the meat on the hob on all sides.

Place in the preheated steam oven and continue to cook gently.

When cooked, arrange on preheated plates and serve with a hot sauce or gravy.

Food	Amount	Accessories	Level	Temperature in °C	Cooking time in min.
Boned leg of lamb	1 - 1.5 kg	baking tray	2	80	140 - 160
Sirloin	1.5 - 2.5 kg	baking tray	2	80	150 - 180
Fillet of pork	-	baking tray	2	80 - 90	50 - 70
Pork medallions	-	baking tray	2	80	60 - 80
Beef steaks	approx. 3 cm thick	baking tray	2	80	40 - 60
Duck breast	-	baking tray	2	80	35 - 55

Bakes, soup ingredients, etc.

Food	Accessories	Level	Operating mode	Temperature in °C	Cooking time in min.
Savoury bake made from cooked ingredients	ovenproof dish + wire rack	2	Hot air + Steam	150 - 170	30 - 40
Sweet bake	ovenproof dish + wire rack	2	Hot air + Steam	150 - 170	30 - 40
Lasagne	baking tray	2	Hot air + Steam	160 - 170	35 - 45
Soufflé	mould + wire rack	2	Hot air + Steam	180 - 200	15 - 25
Royale	solid	2	Steam	90	15 - 20
Semolina dumplings	perforated + baking tray	3 1	Steam	90 - 95	7 - 10
Hard-boiled eggs (size M, max. 1.8 kg)	perforated + baking tray	3 1	Steam	100	10 - 12
Soft-boiled eggs (size M, max. 1 kg)	perforated + baking tray	3 1	Steam	100	6 - 8

Dessert, compote

Compote:

Weigh the fruit and add approximately $\frac{1}{3}$ the amount of water, then add sugar and spices to taste.

Rice pudding

Weigh the rice and add 2.5 times the amount of milk. Ensure the level of rice and milk in the accessory is no higher than 2.5 cm. Stir after cooking. The remaining milk is quickly absorbed.

Yoghurt

Heat the milk to 90 °C on the hob. Then leave to cool to 40 °C. If you are using UHT milk, you do not need to heat it.

Stir in one to two teaspoons of natural yoghurt per 100 ml milk, or the corresponding amount of yoghurt culture into the milk. Pour the mixture into clean jars and seal them.

After preparation, leave the glass jars to cool in the refrigerator.

Food	Accessories	Operating mode	Temperature in °C	Cooking time in min.
Yeast dumplings	baking tray	Steam	100	20 - 25
Crème caramel	mould + wire rack	Steam	90 - 95	15 - 20
Sweet bake (e.g. semolina pudding)	ovenproof dish + wire rack	Hot air + Steam	160 - 170	50 - 60
Rice pudding*	baking tray	Steam	100	25 - 35
Yoghurt*	portion-sized glasses + wire rack	Steam	40	300 - 360
Apple compote	baking tray	Steam	100	10 - 15
Pear compote	baking tray	Steam	100	10 - 15
Cherry compote	baking tray	Steam	100	10 - 15
Rhubarb compote	baking tray	Steam	100	10 - 15
Plum compote	baking tray	Steam	100	15 - 20

* You can also use the appropriate programme (see section: Automatic programmes)

Cakes and pastries

It is best to use dark-coloured metal baking tins.

The temperature and cooking time depend on the quantity and composition of the dough. That is why ranges of temperatures are given in the tables.

First set the lower temperature. This will brown the dish more evenly. A higher temperature can be selected next time, if required.

Do not overpack the wire rack or baking tray with food.

Cakes in tins

Food	Accessories	Level	Operating mode	Temperature in °C	Cooking time in min.
Sponge cake	Ring/loaf tin	2	Hot air	150 - 160	60 - 70
Sponge flan base	flan tin	2	Hot air	150 - 160	30 - 45
Delicate fruit flan, sponge	Springform cake tin	2	Hot air	150 - 160	45 - 55
Sponge base (2 eggs)	flan tin	2	Hot air	180 - 190	12 - 16
Sponge flan (6 eggs)	Springform cake tin	2	Hot air	150 - 160	25 - 35
Shortcrust pastry base with crust	Springform cake tin	2	Hot air	150 - 160	40 - 50
Swiss flan	Springform cake tin	2	Hot air	180 - 190	35 - 60
Ring cake	ring cake tin	2	Hot air + Steam	150 - 160	35 - 45

Food	Accessories	Level	Operating mode	Temperature in °C	Cooking time in min.
Savoury cakes (e.g. quiche)	quiche dish	2	Hot air	180 - 190	35 - 60
Apple tart	flan-base cake tin	2	Hot air	170 - 190	35 - 50

Cakes on trays

Food	Accessories	Level	Operating mode	Temperature in °C	Cooking time in min.
Yeast cake with dry topping	baking tray	2	Hot air + Steam	150 - 160	35 - 45
Yeast cake with moist topping (fruit)	baking tray	2	Hot air	150 - 160	35 - 45
Swiss roll	baking tray	2	Hot air	180 - 200	10 - 15
Plaited loaf (500 g flour)	baking tray + greaseproof paper	2	Hot air + Steam	150 - 160	25 - 35
Strudel, sweet	baking tray	2	Hot air + Steam	160 - 180	40 - 60
Onion tart	baking tray	2	Hot air + Steam	170 - 180	30 - 40

Bread, bread rolls

Food	Accessories	Level	Operating mode	Temperature in °C	Cooking time in min.
White bread (750 g flour)	baking tray + greaseproof paper	2	Hot air + Steam	200 - 210	15 - 20
			Hot air	160 - 170	20 - 25
Sourdough bread (750 g flour)	baking tray + greaseproof paper	2	Hot air + Steam	200 - 220	15 - 25
			Hot air	150 - 160	40 - 60
Multigrain bread (750 g flour)	baking tray + greaseproof paper	2	Hot air + Steam	200 - 220	15 - 20
			Hot air	160 - 170	25 - 40
Wholemeal bread (750 g flour)	baking tray + greaseproof paper	2	Hot air + Steam	200 - 220	20 - 30
			Hot air	140 - 150	40 - 60
Rye bread (750 g flour)	baking tray + greaseproof paper	2	Hot air + Steam	200 - 220	20 - 30
			Hot air	150 - 160	50 - 60
Bread rolls (70 g each, unbaked)	baking tray + greaseproof paper	2	Hot air + Steam	190 - 200	25 - 30
Rolls made with sweet yeast dough (70 g each, unbaked)	baking tray + greaseproof paper	2	Hot air + Steam	170 - 180	20 - 30

Small baked items

Food	Accessories	Level	Operating mode	Temperature in °C	Cooking time in min.
Meringue	baking tray	2	Hot air	80 - 90	120 - 180
Macaroons	baking tray	2	Hot air	140 - 160	15 - 25
Puff pastry	baking tray	2	Hot air + Steam	170 - 190	10 - 20
Muffins	bun tray	2	Hot air	170 - 180	20 - 30
Choux pastry	baking tray	2	Hot air	170 - 190	27 - 35
Biscuits	baking tray	2	Hot air	150 - 160	12 - 17
Leavened cake	baking tray	2	Hot air	150 - 160	15 - 20

Baking tips

You want to bake according to your own recipe	Use similar items in the baking tables as a guide
How to tell whether sponge cake is baked through	Approx. 10 minutes before the end of the baking time stated in the recipe, insert a cocktail stick into the cake at its deepest point. If the cocktail stick comes out clean, the cake is ready.
The cake collapses	Next time, use less liquid or set the baking temperature 10 °C lower. Note the stirring times indicated in the recipe.
The cake has risen in the middle but is lower around the edge	Do not grease the edge of the springform cake tin. After baking, carefully loosen the cake using a knife
Cakes baked in a tray or tin are over-browned at the back	Place the baking tray in the middle of the accessories, not directly against the rear wall

The cake is too dry	Make tiny holes in the finished cake using a cocktail stick. Then drizzle fruit juice or an alcoholic drink over it. Next time, set the temperature 10 °C higher and shorten the baking times or use Hot air + Steam
The bread or cake looks good but it is soggy inside (overmoist with wet streaks)	Next time, use less liquid. Bake at a lower temperature for a little longer. For cakes with a moist topping, bake the base first. Cover the base with almonds or breadcrumbs first and then apply the topping. Observe the baking time in the recipe
The cake or pastry is unevenly browned	Next time, set the temperature a little lower

Reheating food

Using Reheat, dishes can be gently reheated. They taste and look like they have been freshly prepared. Even baked items from the day before can be recrisped.

Food	Accessories	Level	Operating mode	Temperature in °C	Cooking time in min.
Meals on plates	wire rack	2	Reheat	120	12 - 18
Vegetables	baking tray	3	Reheat	100	12 - 15
Pasta, potatoes, rice	baking tray	3	Reheat	100	5 - 10
Bread rolls*	wire rack	2	Hot air + Steam	170 - 180	6 - 8
Baguette*	wire rack	2	Hot air + Steam	170 - 180	5 - 10
Bread*	wire rack	2	Hot air + Steam	170 - 180	8 - 12
Pizza	wire rack + baking tray	3	Reheat	170 - 180	12 - 15

* Preheat for 5 minutes

Defrosting

When freezing, lay the food as flat as possible and in portion-sized pieces at -18 °C. Do not freeze excessively large quantities. Once defrosted, food will not keep for as long and spoils more quickly than fresh food.

Leave the food to defrost in the freezer bag, on a plate or in the perforated cooking container. Always insert the baking tray underneath. The food is then not left lying in the defrost water and the cooking compartment remains clean.

Use the Defrost operating mode.

If necessary, the food can occasionally be split apart or pieces which have already defrosted can be removed from the appliance.

After defrosting, allow the food to stand for a further 5 - 15 minutes to allow the temperatures to even out.

Health risk!

When defrosting food from animal sources, you must remove the liquid that escapes during defrosting. It must never come into contact with other food. Bacteria could be transferred. After defrosting, operate the combination steam oven for 15 minutes using Hot air at 180 °C.

Defrost meat

Allow pieces of meat which are to be breadcrumbed to defrost to the point where seasoning and breadcrumbs adhere to the meat.

Defrosting poultry

Remove from packaging before defrosting. You must tip the defrost liquid away.

Food	Amount	Accessories	Level	Temperature in °C	Cooking time in min.
Chicken	1 kg	perforated + baking tray	3 1	45 - 50	60 - 70
Chicken drumsticks	0.4 kg	perforated + baking tray	3 1	45 - 50	30 - 35
Vegetables frozen in blocks (e.g. spinach)	0.4 kg	perforated + baking tray	3 1	45 - 50	20 - 30
Berries	0.3 kg	perforated + baking tray	3 1	45 - 50	5 - 8
Fish fillet	0.4 kg	perforated + baking tray	3 1	45 - 50	15 - 20
Whole fish	1 kg	perforated + baking tray	3 1	45 - 50	40 - 50
Goulash	-	perforated + baking tray	3 1	45 - 50	40 - 50
Joint of beef	-	perforated + baking tray	3 1	45 - 50	70 - 80

Proving dough

When the Prove operating mode is used, dough will prove considerably more quickly than at room temperature.

You may select any shelf position you wish for the wire rack or place the wire rack carefully on the cooking compartment floor. Caution: do not scratch the cooking compartment floor.

Stand the dough bowl on the wire rack. Do not cover the dough.

Food	Amount	Accessories	Temperature in °C	Cooking time in min.
Yeast dough	1 kg	bowl + wire rack	40	20 - 30
Sourdough	1 kg	bowl + wire rack	40	20 - 30

Juicing

Before juicing, place the berries in a bowl and sprinkle with sugar. Leave to stand for at least one hour to draw out the juice.

Pour the berries into the perforated cooking container and insert at level 3. Insert the baking tray at level 1 to catch the juice.

Finally, place the berries in a cloth and squeeze out the rest of the juice.

Food	Accessories	Level	Mode of operation	Temperature in °C	Duration in min
Raspberries	Perforated cooking container + baking tray	3 1	Steam	100	30 - 45
Red currants	Perforated cooking container + baking tray	3 1	Steam	100	40 - 50

Preserving

Preserve food which is as fresh as possible. When foods are stored for a relatively long period, their vitamin content is reduced and they ferment and spoil more easily.

Only use fruit and vegetables which are in perfect condition.

The following foods cannot be preserved with your appliance: Contents of tins, meat, fish or pastry dough.

Check preserving jars, rubber rings, clips and springs.

Clean rubber rings and jars thoroughly with hot water. The "Sterilise bottles" programme is also suitable for cleaning glasses.

Place the jars in the perforated cooking container. They must not be in contact with each other.

After the specified cooking time, open the appliance door.

Do not remove the preserving jars from the appliance until they have completely cooled down.

Food	Accessories	Position	Type of heating	Temperature in °C	Cooking time in min.
Vegetables	1-litre preserving jars	2	Steam	100	30 - 120
Stone fruits	1-litre preserving jars	2	Steam	100	25 - 30
Pip fruits	1-litre preserving jars	2	Steam	100	25 - 30

Frozen products

Observe the instructions on the packaging.

The cooking times indicated apply to dishes placed in a cold cooking compartment.

Food	Accessories	Level	Operating mode	Temperature in °C	Cooking time in min.
Chips	baking tray + greaseproof paper	2	Hot air	170 - 190	25 - 35
Croquettes	baking tray + greaseproof paper	2	Hot air	180 - 200	18 - 22
Rösti	baking tray + greaseproof paper	2	Hot air	180 - 200	25 - 30
Pasta, fresh, refrigerated*	baking tray	2	Steam	100	5 - 10
Lasagne, frozen	baking tray + wire rack	2	Hot air + Steam	190 - 210	35 - 55
Pizza, thin base	baking tray + wire rack	2	Hot air	180 - 200	15 - 23
Pizza, deep-pan	baking tray + wire rack	2	Hot air	180 - 200	18 - 25
Pizza baguette	baking tray + wire rack	2	Hot air	180 - 200	18 - 22
Pizza, chilled	baking tray	2	Hot air	170 - 180	12 - 17
Herb butter baguette, refrigerated	baking tray	2	Hot air	180 - 200	15 - 20

* Add a little liquid

Food	Accessories	Level	Operating mode	Temperature in °C	Cooking time in min.
Bread rolls, baguette, frozen	baking tray + wire rack	2	Hot air	180 - 200	18 - 22
Pretzels, frozen	baking tray + greaseproof paper	2	Hot air	180 - 200	18 - 22
Croissant, frozen	baking tray + greaseproof paper	2	Hot air + Steam	180 - 200	20 - 25
Part-cooked rolls or baguette, pre-baked	baking tray + greaseproof paper	2	Hot air	150 - 170	12 - 15
Strudel, frozen	baking tray + greaseproof paper	2	Hot air + Steam	160 - 180	45 - 60
Fish fingers	baking tray + greaseproof paper	2	Hot air	195 - 205	20 - 24
Trout	perforated + baking tray	3 1	Steam	80 - 100	20 - 25
Frozen fish fillet with topping	baking tray + wire rack	2	Hot air + Steam	180 - 200	35 - 50
Salmon fillet	Perforated cooking container + baking tray	3 1	Steam	80 - 100	20 - 25
Squid rings	baking tray + greaseproof paper	2	Hot air	190 - 210	25 - 30
Broccoli	Perforated cooking container + baking tray	3 1	Steam	100	4 - 6
Cauliflower	Perforated cooking container + baking tray	3 1	Steam	100	5 - 8
Beans	Perforated cooking container + baking tray	3 1	Steam	100	4 - 6
Peas	Perforated cooking container + baking tray	3 1	Steam	100	4 - 6
Carrots	Perforated cooking container + baking tray	3 1	Steam	100	3 - 5
Mixed vegetables	Perforated cooking container + baking tray	3 1	Steam	100	4 - 8
Brussels sprouts	Perforated cooking container + baking tray	3 1	Steam	100	5 - 10

* Add a little liquid

Test dishes

In accordance with EN 50304/EN 60350 (2009), and IEC 60350.

The values in the table apply to dishes placed in a cold cooking compartment.

Food	Accessories	Level	Operating mode	Temperature in °C	Cooking time in min.
Piped cookies	baking tray	2	Hot air	160 - 170	17 - 20
Small cakes	baking tray	2	Hot air	160 - 170	25 - 33
Hot water sponge cake	26 cm springform cake tin	2	Hot air	150 - 160	35 - 40
German apple pie	20 cm springform cake tin	2	Hot air	160 - 170	60 - 70

Siemens-Electrogeräte GmbH
Carl-Wery-Straße 34
81739 München
Germany



9000746534 45 920904