



**PIA6..T1..**  
**Hob**



**BOSCH**

[en] Instructions for installation and use

PIA6..T1..

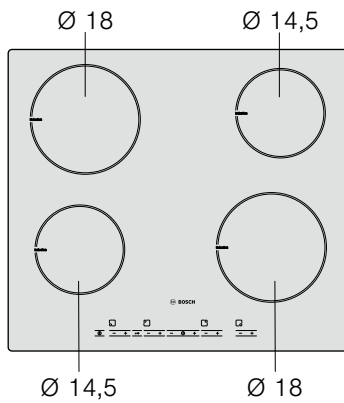

## en Table of contents

<b>INSTALLATION INSTRUCTIONS.....</b>	<b>3</b>
<b>Assembly .....</b>	<b>3</b>
Important notes .....	4
Installing and connecting the hob - Figure 1/2/3/4/5 .....	4
Removing the hob .....	4
<b>INSTRUCTION MANUAL.....</b>	<b>5</b>
<b>Safety precautions .....</b>	<b>5</b>
Elements that may damage the appliance .....	7
<b>Protecting the environment.....</b>	<b>7</b>
Environmentally-friendly disposal of waste products .....	7
Energy-saving advice .....	7
<b>Induction cooking .....</b>	<b>8</b>
Advantages of induction cooking .....	8
Suitable pans .....	8
<b>Familiarise yourself with the appliance.....</b>	<b>9</b>
The control panel .....	9
The hotplates .....	9
Residual heat indicator .....	9
<b>Programming the hob .....</b>	<b>9</b>
Turning the hob on and off .....	9
Setting the hotplate .....	9
Cooking guidelines table.....	10
<b>Time programming function.....</b>	<b>10</b>
Turning off a hotplate automatically .....	10
The timer.....	11
<b>Childproof lock .....</b>	<b>11</b>
Activating and deactivating the childproof lock.....	11
Activating and deactivating the childproof lock.....	11
<b>Automatic time limitation .....</b>	<b>11</b>
<b>Basic settings.....</b>	<b>11</b>
Accessing the basic settings.....	12
<b>Care and cleaning .....</b>	<b>12</b>
Hob .....	12
Hob frame .....	12
<b>Fixing malfunctions .....</b>	<b>13</b>
Normal noise while the appliance is working.....	13
<b>After-sales service .....</b>	<b>14</b>

# INSTALLATION INSTRUCTIONS

## Assembly

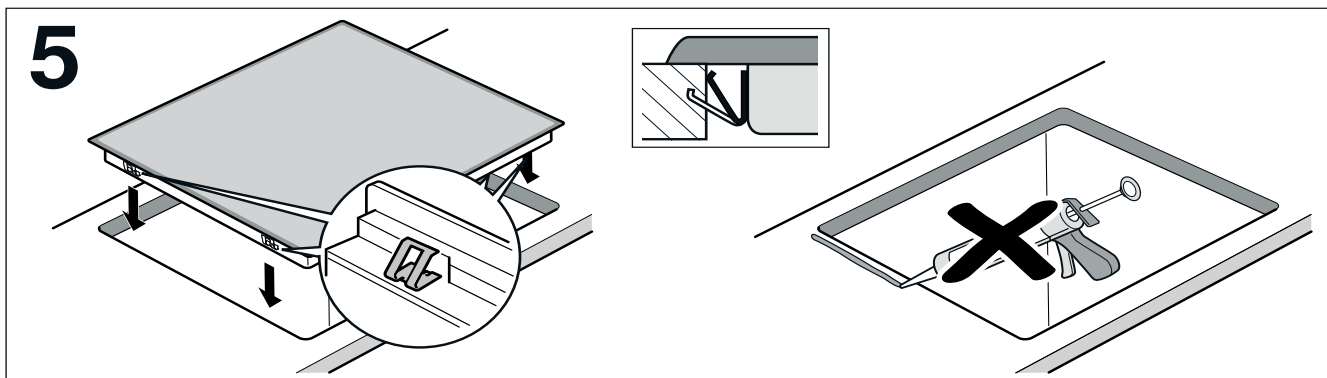
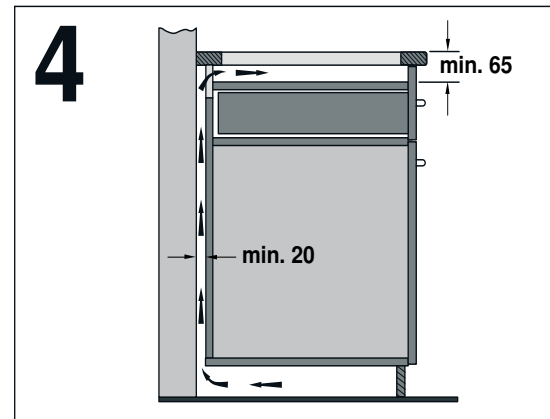
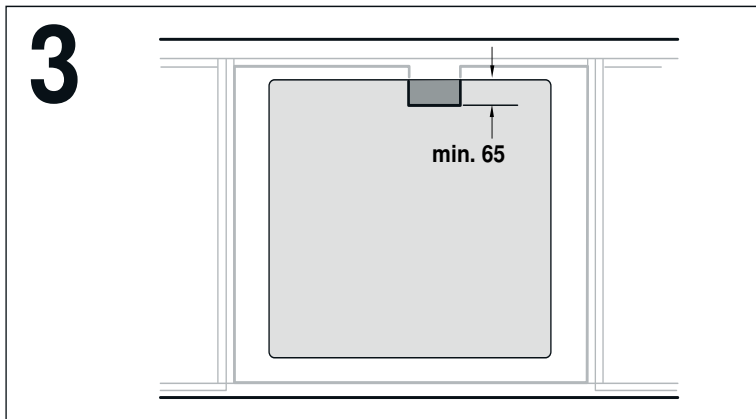
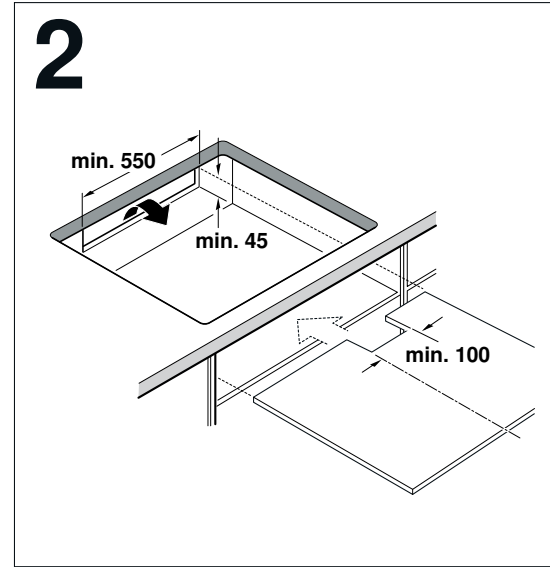
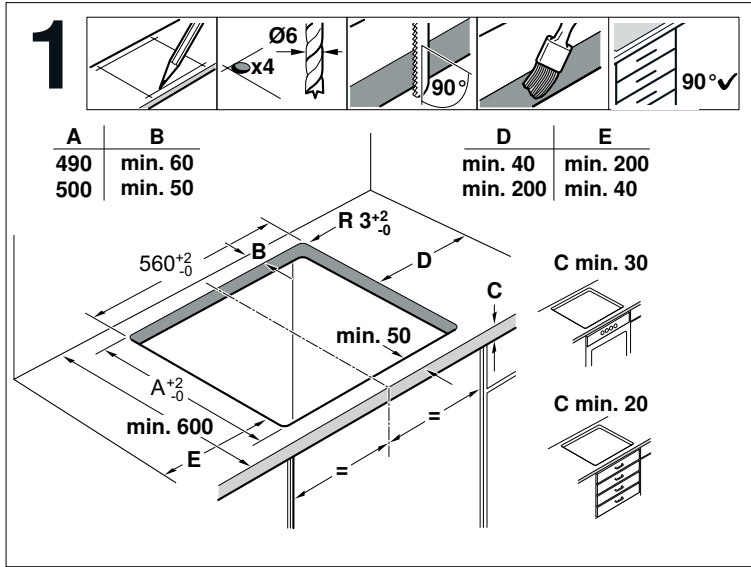

## Important notes

Safety in use is only guaranteed if the technical installation of the hob has been carried out correctly and in accordance with the installation instructions. The installation technician shall be liable for any damage caused as a result of incorrect installation.

Only an authorised technician is able to connect the appliance. The guidelines set out by the local electricity provider must be observed.

This is a class I appliance and should only be used with an earthed connection.

Using this appliance without an earth connection or after it has been incorrectly installed may, under very rare circumstances, cause serious harm.

The manufacturer accepts no responsibility for any malfunction or damage caused by incorrect electrical installation.

If the appliance is not fitted with an accessible plug, means for disconnecting it must be incorporated in the fixed installation, in accordance with the installation regulations.

The inlet hose must be positioned so that it does not touch any of the hot parts of the hob or oven.

Induction hobs may only be installed over ovens with the same brand of forced-air ventilation. Refrigerators, unventilated ovens, and washing machines may not be installed beneath the hob.

If the hob is installed above a drawer, metal objects stored inside the drawer could become very hot due to the air recirculating from the hob ventilation system. If this occurs, an intermediate support is recommended.

A wooden panel can be used as an intermediate support or you may order a suitable accessory from our Technical Assistance Service.

The reference code for this accessory is 680502.

Any change to the appliance's interior, including changing the power cable, must be performed by the Technical Assistance Service.

## Installing and connecting the hob - Figure 1/2/3/4/5

Voltage, see specifications plate.

Connect using the connection drawing only.

## Removing the hob

Disconnect the appliance from the mains.

Remove the hob by pushing it from below.

---

# INSTRUCTION MANUAL

Additional information on products, accessories, replacement parts and services can be found at [www.bosch-home.com](http://www.bosch-home.com) and in the online shop [www.bosch-eshop.com](http://www.bosch-eshop.com)

---

## **⚠ Safety precautions**

Please read this manual carefully. Please keep the instruction and installation manual as well as the appliance certificate in a safe place for later use or for subsequent owners.

Check the appliance after removing it from the packaging. If it has suffered any damage in transport, do not connect the appliance, contact the Technical Assistance Service and provide written notification of the damage caused, otherwise you will lose your right to any type of compensation.

This appliance must be installed according to the installation instructions included.

This appliance is intended for domestic use only. The appliance must only be used for the preparation of food and drink. The appliance must be supervised during operation. Only use this appliance indoors.

This appliance is not intended for operation with an external clock timer or a remote control.

This appliance may be used by children over the age of 8 years old and by persons with reduced physical, sensory or mental capacity or by persons with a lack of experience or knowledge if they are supervised or are instructed by

a person responsible for their safety how to use the appliance safely and have understood the associated hazards.

Children must not play with the appliance. Children must not clean the appliance or carry out general maintenance unless they are at least 8 years old and are being supervised.

Keep children below the age of 8 years old at a safe distance from the appliance and power cable.

### **Risk of fire!**

- Hot oil and fat can ignite very quickly. Never leave hot fat or oil unattended. Never use water to put out burning oil or fat. Switch off the hotplate. Extinguish flames carefully using a lid, fire blanket or something similar.
- The hotplates become very hot. Never place combustible items on the hob. Never place objects on the hob.
- The appliance gets hot. Do not keep combustible objects or aerosol cans in drawers directly underneath the hob.

- The hob switches off automatically and can no longer be operated. It may switch on unintentionally at a later point. Switch off the circuit breaker in the fuse box. Contact the after-sales service.
- A defective appliance may cause electric shock. Never switch on a defective appliance. Unplug the appliance from the mains or switch off the circuit breaker in the fuse box. Contact the after-sales service.

### **Risk of burning!**

- The hotplates and the area around them get very hot. Never touch the hot surfaces. Keep children away.
- The hotplate heats up but the display does not work. Switch off the circuit breaker in the fuse box. Contact the after-sales service.
- Metal objects on the hob quickly become very hot. Never place metal objects (such as knives, forks, spoons and lids) on the hob.
- After each use, always turn off the hob at the main switch. Do not wait until the hob turns off automatically after the pan is removed.

### **Risk of electric shock!**

- Incorrect repairs are dangerous. Repairs may only be carried out and damaged power cables replaced by one of our trained after-sales technicians. If the appliance is defective, unplug the appliance from the mains or switch off the circuit breaker in the fuse box. Contact the after-sales service.
- Penetrating moisture may cause an electric shock. Do not use any high-pressure cleaners or steam cleaners.

- Cracks or fractures in the glass ceramic may cause electric shocks. Switch off the circuit breaker in the fuse box. Contact the after-sales service.

### **Electromagnetic hazards!**

This appliance complies with safety and electromagnetic compatibility standards. However, people with pacemakers or insulin pumps must refrain from using this appliance. It is impossible to ensure that all of these devices available on the market comply with current electromagnetic compatibility standards, and that interference which may prevent the device from working correctly will not occur. It is also possible that people with other types of devices, such as a hearing aids, could experience some discomfort.

### **Malfunction risk!**

The hob is equipped with a fan in the lower section. If there is a drawer under the hob it should not be used to store small objects or paper, since they could damage the fan or interfere with the cooling if they are sucked into it.

There should be a minimum of 2 cm between the contents of the drawer and fan intake.

## Risk of injury!

- When cooking in a bain marie, the hob and cooking container could shatter due to overheating. The cooking container in the bain marie must not directly touch the bottom of the water-filled pot. Only use heat-resistant cookware.

- Saucepans may suddenly jump due to liquid between the pan base and the hotplate. Always keep the hotplate and saucepan bases dry.

## Elements that may damage the appliance

### Caution!

- Rough pan bases may scratch the hob.
- Avoid leaving empty pots and pans on the hotplate. Doing so may cause damage.
- Do not place hot pans on the control panel, the indicator area, or the hob frame. Doing so may cause damage.

- Hard or pointed objects dropped on the hob may damage it.
- Aluminium foil and plastic containers will melt if placed on the hotplate while it is hot. The use of laminated sheeting is not recommended on the hob.

### Overview

The following table presents the most common damage caused:

Damage	Cause	Measure
Stains	Food spillage	Immediately remove spilt food using a glass scraper.
	Unsuitable cleaning products	Only use cleaning products specifically designed for glass-ceramic hobs.
Scratches	Salt, sugar and sand	Do not use the hob as a tray or working surface.
	Pans with rough bottoms may scratch the glass ceramic	Check pans.
Fading	Unsuitable cleaning products	Only use cleaning products specifically produced for glass-ceramic hobs.
	Contact with pans	Lift pots and pans before moving them around.
Chips	Sugar, substances with a high sugar content	Immediately remove spilt food using a glass scraper.

## Protecting the environment

Unpack the appliance and dispose of its packaging in such a way that no damage is caused to the environment.

### Environmentally-friendly disposal of waste products



This appliance conforms to the Waste Electrical and Electronic Equipment Directive WEEE 2002/96/EC. This directive defines the framework for recycling used appliances within European territory

### Energy-saving advice

- Always place the correct lid on cookware. Cooking with an uncovered pan will result in a four-fold increase in energy use. Use a glass lid to provide visibility and avoid having to lift the lid.
- Use cookware equipped with a solid, flat bottom. Curved pan bases increase energy consumption.
- The diameter of the pan base must match the size of the hotplate. If not, energy may be wasted. Note: The manufacturer normally indicates the pan's upper diameter. This is normally greater than the diameter of the pan's base.
- Choose cookware of a size suited to the amount of food you are going to cook. A large pan that is only half full will use a lot of energy.
- Use a small amount of water when cooking. This saves energy, and vegetables retain their vitamins and minerals.
- Select a lower power level.

# Induction cooking

## Advantages of induction cooking

Induction cooking represents a radical change from the traditional method of heating; the heat is generated directly in the pan. It therefore offers a number of advantages:

- Time savings for cooking and frying; since the pan is heated directly.
- Energy is saved.
- Care and cleaning are simpler. Foods that have spilt do not burn as quickly.
- Heat and safety control; the hob supplies or cuts off power immediately when the control knob is turned on. The induction hotplate stops supplying heat if the pan is removed without having previously switched it off.

## Suitable pans

### Ferromagnetic pans

Only ferromagnetic pans are suitable for induction cooking, these may be made from:

- enamelled steel
- cast iron
- special cutlery for stainless steel induction pan

To determine whether a pan is suitable, check to see if a magnet will stick to it.

### Other suitable cookware for induction

There are other types of cookware especially made for induction whose base is not entirely ferromagnetic.

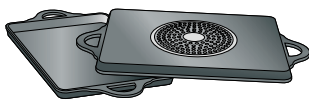

When using large cookware on a smaller ferromagnetic zone, only the ferromagnetic zone heats up, so heat might not be uniformly distributed.

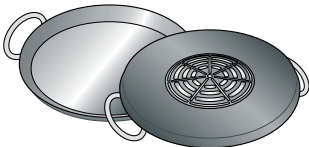

Cookware with aluminium on the base reduce the ferromagnetic zone, so less heat may be supplied or be difficult to detect.

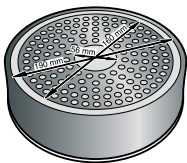

For good cooking results, the diameter of the cookware's ferromagnetic area should match the size of the hotplate. If cookware is not detected on a hotplate, try it on the next smaller hotplate down.

## Unsuitable pans

Never use pans made from:

- common thin steel
- glass
- earthenware
- copper
- aluminium

## Characteristics of the pan base

The characteristics of the pan base may affect the uniformity of the cooking results. Pans made from materials which help diffuse heat, such as stainless steel sandwich pans, distribute heat uniformly, saving time and energy.

## Absence of pan or unsuitable size

If no pan is placed on the selected hotplate, or if it is made of unsuitable material or is not the correct size, the power level displayed on the hotplate indicator will flash. Place a suitable pan on the hotplate to stop the flashing. If this takes more than 90 seconds, the hotplate will switch off automatically.

## Empty pans or those with a thin base

Do not heat empty pans, nor use pans with a thin base. The hob is equipped with an internal safety system. However, an empty pan may heat up so quickly that the "automatic switch off" function may not have time to react and the pan may reach very high temperatures. The base of the pan could melt and damage the glass on the hob. In this case, do not touch the pan and switch the hotplate off. If it fails to work after it has cooled down, please contact the Technical Assistance Service.

## Pan detection

Each hotplate has a minimum limit for detecting pans, which varies depending on the material of the pan being used. You should therefore use the hotplate that is most suitable for the diameter of your pan.



# Familiarise yourself with the appliance

An overview of models is provided on *page 2*.

## The control panel

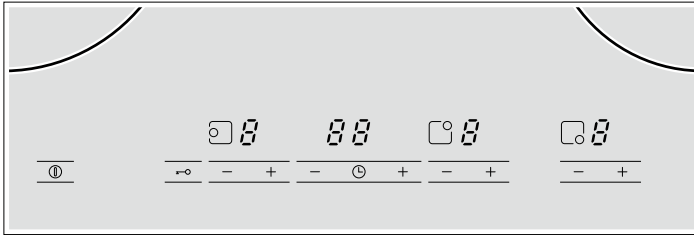
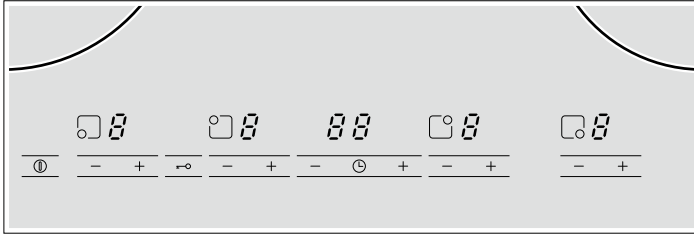

Control panels	Function
①	Main switch
-/+	Select power level
🕒	Time program
🔒	Childproof lock/Basic settings

## The hotplates

Hotplate	Activating and deactivating
○ Single hotplate	Use a correctly sized pan.
⊞ Grill plate	The hotplate turns on automatically when a pan the same size as its outer edges is placed on it.

## Residual heat indicator

The hob has a residual heat indicator for each hotplate to show those which are still hot. Avoid touching a hotplate that displays this.

Even when switched off, the *h/H* light will remain on as long as the hotplate remains hot.

If the pan is removed before the hotplate is turned off the *h/H* indicators and the selected power level will appear alternately.

# Programming the hob

## Turning the hob on and off

To turn on: Press the ① symbol. The indicator above the main switch lights up.

To turn off: press the ① symbol until the indicator above the main switch disappears. The residual heat indicator stays lit until the hotplates have cooled sufficiently.

**Note:** The hob switches off automatically when all the hotplates are switched off for more than 20 seconds.

## Setting the hotplate

The hob must be switched on.

1. Press the + or - symbol for the required hotplate. The  symbol lights up on the display.

2. Press the + or - symbol within the next 10 seconds. The basic setting appears.

- + symbol = power level 9.
- symbol = power level 4.

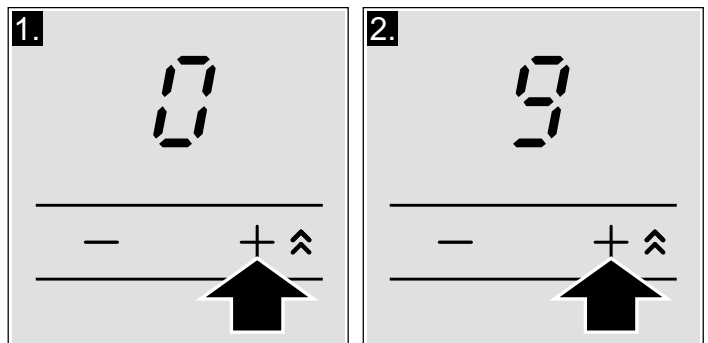

3. To change the power level: Press the + or - symbol until the required power level appears.

## Switch off the hotplate

Press the + or - symbol until  appears.

**Note:** If no pan has been placed on the induction hotplate, the selected power level flashes. After a certain time, the hotplate switches off.

## Cooking guidelines table

The table below contains some examples.

Use power level 9 to begin cooking.

	Power level
<b>Melting</b>	
Chocolate, chocolate coating, butter, honey	1-1.
Gelatine	1-1.
<b>Heating and keeping warm</b>	
Stew (e.g., lentils)	1-2
Milk**	1.-2.
Sausages heated in water**	3-4
<b>Defrosting and heating</b>	
Frozen spinach	2.-3.
Frozen goulash	2.-3.
<b>Slow cooking, simmering</b>	
Potato dumplings	4.-5.*
Fish	4-5*
White sauces (e.g., bechamel)	1-2
Whipped sauces (e.g., Bearnaise, Hollandaise)	3-4
<b>Boiling, steaming, sautéing</b>	
Rice (with a double amount of water)	2-3
Rice pudding	1.-2.
Potatoes	4-5
Pasta	6-7*
Soups	3.-4.
Vegetables	2.-3.
Greens, frozen foods	3.-4.
Cooked in a pressure cooker	4.-5.

\* Uncovered cooking

\*\* Uncovered

	Power level
<b>Stewing</b>	
Meat roll	4-5
Stew	4-5
Goulash	3.-4.
<b>Bake / Fry with a little oil**</b>	
Steaks, chops (plain or breaded)	6-7
Beefsteak (3 cm thick)	7-8
Chicken breast (2 cm thick)	5-6
Plain fish and fish fillet	5-6
Breaded fish and fish fillet	6-7
Prawns and shrimps	7-8
Frozen meals (e.g., stir-fries)	6-7
Pancakes	6-7
Omelette	3.-4.
<b>Frying**</b> (150-200 g per serving with 1-2 l. of oil)	
Frozen foods (e.g., French fries, chicken nuggets)	8-9
Frozen croquettes	7-8
Meatballs	7-8
Meat (e.g., chicken pieces)	6-7
Fish, vegetables or mushrooms, breaded or battered, e.g., baby mushrooms	6-7
Confectionery products (e.g., fritters, fruit in batter)	4-5

\* Uncovered cooking

\*\* Uncovered

## Time programming function





This function may be used in two different ways:

- to automatically switch off a hotplate.
- as a timer.

### Turning off a hotplate automatically

Enter the cooking time for the required hotplate. The hotplate turns off automatically once the time has elapsed.

#### How to program

1. Select the required power level.
2. Press the  symbol. The  indicator on the hotplate lights up.  is displayed on the time program function display. To select another hotplate, press the  symbol several times until the  indicator for the desired hotplate lights up.

3. Press the **+** or **-** symbol on the time program function. The basic setting appears:

**+** symbol: 30 minutes.

**-** symbol: 10 minutes.



4. Press the **+** or **-** symbol until the required cooking time appears.

After a few seconds, the cooking time begins to count down.



#### Once the time has elapsed

The hotplate switches off. A warning signal sounds. Pressing the  symbol turns off the indicators and stops the beeping.

## Changing or cancelling the time

Press the  symbol several times until the required  indicator lights up. Change the cooking time using the + or - symbols, or set to .



### Notes

- If a cooking time has been programmed in several zones, it can be set to display all time values. To do this, press the  symbol several times until the  indicator for the required hotplate lights up.
- Cooking times of up to 99 minutes can be programmed.



## The timer

The timer can be set for periods of up to 99 minutes. It is independent of the other settings. This function does not automatically switch off a hotplate.

## How to program



1. Press the  symbol several times until the  indicator lights up.  is displayed on the time program function display.
2. Set the time required using the + or - symbols.  
After a few seconds, the timer will start to count down.

### Once the time has elapsed

A warning beep sounds. In the time program function display  is shown, and the  indicator comes on. After 10 seconds the indicators turn off.

Pressing the  symbol turns off the indicators and stops the beep.

### Changing or cancelling the time



Press the  symbol several times until the  indicator lights up. Change the cooking time or set to  with the symbols + or -.

# Childproof lock

The hob can be protected against being accidentally turned on, to ensure that children do not switch on the hotplates.

## Activating and deactivating the childproof lock.

The range must be turned off.

To turn on: press and hold the  symbol for approx. 4 seconds. The  indicator lights up for 10 seconds. The range is locked.

To turn off: press and hold the  symbol for approx. 4 seconds. The lock is now deactivated.

## Activating and deactivating the childproof lock



With this function, the childproof lock automatically activates when a hob is switched off.

### Activating and deactivating

See the "Basic Settings" section.

# Automatic time limitation











If the hotplate remains in use for a long time (depending on the power level selected from 1 to 10 hours) and no changes are made in the settings, the automatic time limitation function is

triggered. The hotplate stops heating. On the hotplate display,  and  flash alternately.

The indicator goes out when any symbol is pressed.

# Basic settings

The device has several basic settings. These settings may be adapted to the user's individual needs.

Indicator	Function
	<b>Childproof lock</b>  Deactivated.*  Activated.
	<b>Sound signals</b>  Confirmation beep and error signal deactivated.  Only confirmation beep deactivated.  All signals activated.*
	<b>Automatic timer</b>  Switched off.*  Automatic shut-off time

\*Factory settings

Indicator	Function
<b>c 6</b>	<b>Duration of the time program function warning signal</b> <i>1</i> 10 seconds*. <i>2</i> 30 seconds. <i>3</i> 1 minute.
<b>c 7</b>	<b>Power-Management function</b> <i>0</i> = Deactivated.* <i>1</i> = 1,000 W. minimum power. <i>1</i> = 1,500 W. <i>2</i> = 2,000 W. etc. <i>9</i> or <i>9</i> . = maximum power of the hob.
<b>c 0</b>	<b>Return to basic settings</b> <i>0</i> Personal settings.* <i>1</i> Return to factory settings.

\*Factory settings

## Accessing the basic settings

The hob should be turned off.

1. Turn on the hob.
2. Within the next 10 seconds, press the **↔** symbol for 4 seconds.

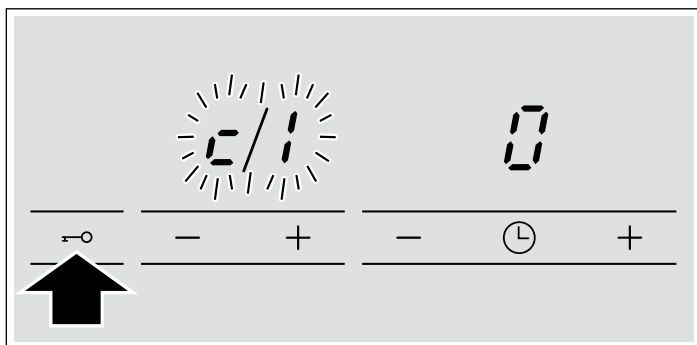

**c 1** is displayed on the left of the screen and **0** on the right.

3. Press the **↔** symbol several times until the required function appears.
4. Then select the required setting using the **+** and **-** symbols for the corresponding hotplate to the right of the **↔** symbol. The new setting will appear on the time program function display.
5. Press the **↔** symbol again for more than 4 seconds. The settings will have been correctly saved.

### Quit

To leave the basic settings, turn off the hob at the main switch.

## Care and cleaning

### Hob

#### Cleaning

Clean the hob after each use. This prevents food remains left on the surface from burning. Wait until the hob is cold enough before attempting to clean it.

Only use cleaning products specifically designed for glass-ceramic hobs. Follow the instructions provided on the packaging.

Do not use: abrasives, harsh cleaners (such as oven sprays and stain removers), sponge scourers, high pressure cleaners or steam

#### Glass scraper

Do not attempt to clean the hob surface with the base of the scraper. This could result in scratching.

#### **⚠ Risk of injury!!**

The blade is extremely sharp. Risk of cuts. Protect the blade when not in use. Replace the blade immediately when any imperfections are found.

### Care of the appliance

Apply an additive to protect and preserve the hob. Follow the advice and warnings provided with the product.

### Hob frame

In order to avoid damage to the hob frame, follow the indications below:

- Use only slightly soapy hot water
- Do not use sharp or abrasive products
- Do not use a glass scraper

# Fixing malfunctions

Malfunctions are generally caused by minor faults. Before contacting the Technical Assistance Service, make sure you have read the following recommendations and warnings.

Indicator	Malfunction	Measure
none	The electric power supply has been interrupted. The appliance has not been correctly connected following the connection diagram. Electronic system malfunction.	Use other electrical appliances to check if there has been a power cut. Make sure that the appliance has been connected correctly. If in the above checks, the malfunction is not resolved, contact the Technical Assistance Service.
<i>E</i> flashing	The control panel is wet or an object is resting on it.	Dry the control panel area or remove the object.
<i>E<sub>r</sub></i> + number / <i>d</i> + number / <i>e</i> + number	Electronic system malfunction.	Disconnect the hob from the mains. Wait 30 seconds or so, then connect it again.*
<i>F0</i> / <i>F9</i>	There is an internal error in the system.	Disconnect the hob from the mains. Wait 30 seconds or so, then connect it again.*
<i>F2</i>	The electronic system has overheated and the corresponding hotplate has been switched off.	Wait until the electronic system has cooled down completely. Then press any symbol on the hob.*
<i>F4</i>	The electronic system has overheated and all hotplates have been switched off.	
<i>U1</i>	Supply voltage outside normal operating limits.	Please contact the local electricity board.
<i>U2</i> / <i>U3</i>	The hotplate has overheated and switched off to protect its working surface.	Wait until the electronic system has cooled down sufficiently before switching it back on.

\* If the warning persists call the Technical Assistance Service.

**Do not place hot pans on the control panel.**

## Normal noise while the appliance is working

Induction heating technology is based on the creation of electromagnetic fields that generate heat directly at the base of the pan. Depending on how the pan has been manufactured, these may produce certain noises or vibrations such as those described below:

### A deep humming sound as in a transformer

This noise is produced when cooking on a high power level. It is caused by the amount of energy transferred from the hob to the pan. The noise disappears or becomes faint when the power level is lowered.

### A low whistling sound

This noise is produced when the pan is empty. It disappears when water or food is added to the pan.

### A crackling sound

This noise occurs in pans which are made from different materials superimposed on one another. It is caused by the vibrations that occur adjoining surfaces of the different superimposed materials. The noise comes from the pan. The amount of food and cooking method can vary.

### A high-pitched whistling sound

This noise is produced mainly in pans made from different materials superimposed on one another, and it occurs when such pans are heated at maximum power on two hotplates at the same time. The whistling disappears or becomes fainter as soon as the power level is lowered.

### Noise from the fan

For proper use of the electronic system, the temperature of the hob must be controlled. For this purpose, the hob has a fan that starts working after detecting excess temperatures at different power levels. The fan may also work due to inertia after the hob has been switched off, if the temperature detected is still too high.

The noises described are normal, they are part of induction heating technology and not a sign of malfunction.

---

## After-sales service

Our after-sales service is there for you if your appliance should need to be repaired. We are committed to find the best solution also in order to avoid an unnecessary call-out.

### **E number and FD number:**

Please quote the E number (product number) and the FD number (production number) of your appliance when contacting the after-sales service. The rating plate bearing these numbers can be found on the appliance certificate.

Please note that a visit from an after-sales service engineer is not free of charge, even during the warranty period.

Please find the contact data of all countries in the enclosed customer service list.

### **To book an engineer visit and product advice**

**GB** 0844 8928979

Calls from a BT landline will be charged at up to 3 pence per minute. A call set-up fee of up to 6 pence may apply.

**IE** 01450 2655

Trust the expertise of the manufacturer, and rest assured that the repair will be carried out by trained service technicians using original spare parts for your domestic appliance.





**Robert Bosch Hausgeräte GmbH**

Carl-Wery-Straße 34

81739 München

Germany

**[www.bosch-home.com](http://www.bosch-home.com)**



9000732140

00  
911206