



Register your new Bosch now:  
[www.bosch-home.com/welcome](http://www.bosch-home.com/welcome)



**Compact oven with microwave  
HBC86K753B**



**BOSCH**

[en] Instruction manual



# Table of contents

<b>Important safety information</b> .....	<b>4</b>	<b>Sabbath mode</b> .....	<b>16</b>
Causes of damage .....	6	Starting Sabbath mode .....	16
<b>Your new appliance</b> .....	<b>7</b>	The cooking time has elapsed.....	16
Control panel .....	7	Setting a later end time .....	16
Buttons .....	7	Cancelling Sabbath mode.....	16
Rotary selector.....	7	<b>Childproof lock</b> .....	<b>16</b>
Display .....	7	<b>Basic settings</b> .....	<b>17</b>
Temperature indicator .....	7	Changing the basic settings .....	18
Cooking compartment.....	8	<b>Automatic switch-off</b> .....	<b>18</b>
<b>Your accessories</b> .....	<b>8</b>	<b>Care and cleaning</b> .....	<b>18</b>
Inserting accessories.....	8	Cleaning agents.....	18
Optional accessories.....	9	Cleaning the glass cover .....	19
After-sales service products.....	9	Cleaning the glass panels.....	19
<b>Before using the appliance for the first time</b> .....	<b>9</b>	<b>Malfunction table</b> .....	<b>20</b>
Initial setup.....	9	Malfunction table .....	20
Heating up the cooking compartment.....	9	Replacing the oven light bulb .....	21
Cleaning the accessories.....	9	Replacing the door seal .....	21
<b>Switching the oven on and off</b> .....	<b>10</b>	<b>After-sales service</b> .....	<b>22</b>
Switching on .....	10	E number and FD number .....	22
Switching off .....	10	<b>Energy and environment tips</b> .....	<b>22</b>
<b>Setting the oven</b> .....	<b>10</b>	Saving energy.....	22
Types of heating .....	10	Environmentally-friendly disposal.....	22
Setting the type of heating and temperature.....	10	<b>Automatic programmes</b> .....	<b>22</b>
Recommended settings .....	11	Ovenware.....	22
Setting rapid heating .....	11	Selecting a programme.....	23
<b>The microwave</b> .....	<b>12</b>	Individually adjusting the cooking result:.....	23
Notes regarding ovenware .....	12	Defrosting and cooking with the automatic programmes.....	23
Microwave power settings.....	12	<b>Tested for you in our cooking studio</b> .....	<b>28</b>
Setting the microwave .....	12	Defrosting, heating up and cooking with the microwave.....	28
<b>MicroCombi</b> .....	<b>12</b>	Microwave tips.....	31
MicroCombi, gentle .....	12	Cakes and pastries .....	31
MicroCombi, intensive .....	13	Baking tips .....	33
Setting MicroCombi.....	13	Roasting and grilling .....	33
<b>Combination</b> .....	<b>13</b>	Tips for roasting and grilling .....	36
Suitable microwave power settings .....	13	Bakes, gratins, toast with toppings.....	37
Setting a combination.....	13	Convenience products .....	37
<b>Series of operations</b> .....	<b>14</b>	<b>Slow cooking</b> .....	<b>38</b>
Ovenware .....	14	Setting the Slow cook option .....	38
Setting a series of operations .....	14	Tips for slow cooking .....	38
<b>Time-setting options</b> .....	<b>14</b>	<b>Test dishes</b> .....	<b>39</b>
Setting the cooking time .....	14	Baking.....	39
Setting a later end time .....	15	Grilling.....	40
Setting the timer.....	15	<b>Acrylamide in foodstuffs</b> .....	<b>40</b>
Setting the clock.....	15		
<b>Memory</b> .....	<b>16</b>		
Storing settings in the memory .....	16		
Starting the memory .....	16		

Additional information on products, accessories, replacement parts and services can be found at [www.bosch-home.com](http://www.bosch-home.com) and in the online shop [www.bosch-eshop.com](http://www.bosch-eshop.com)

## Important safety information

Read these instructions carefully. Only then will you be able to operate your appliance safely and correctly. Retain the instruction manual and installation instructions for future use or for subsequent owners.

This appliance is only intended to be fully fitted in a kitchen. Observe the special installation instructions.

Check the appliance for damage after unpacking it. Do not connect the appliance if it has been damaged in transport.

Only a licensed professional may connect appliances without plugs. Damage caused by incorrect connection is not covered under warranty.

This appliance is intended for domestic use only. The appliance must only be used for the preparation of food and drink. The appliance must be supervised during operation. Only use this appliance indoors.

This appliance may be used by children over the age of 8 years old and by persons with reduced physical, sensory or mental capabilities or by persons with a lack of experience or knowledge if they are supervised or are instructed by a person responsible for their safety how to use the appliance safely and have understood the associated hazards.

Children must not play with, on, or around the appliance. Children must not clean the appliance or carry out general maintenance unless they are at least 8 years old and are being supervised.

Keep children below the age of 8 years old at a safe distance from the appliance and power cable.

Always slide accessories into the cooking compartment correctly. See "*Description of accessories*" in the instruction manual.

### **Risk of fire!**

- Combustible items stored in the cooking compartment may catch fire. Never store combustible items in the cooking compartment. Never open the appliance door if there is smoke inside. Switch off the appliance and unplug it from the mains or switch off the circuit breaker in the fuse box.
- A draught is created when the appliance door is opened. Greaseproof paper may come into contact with the heating ele-

ment and catch fire. Do not place greaseproof paper loosely over accessories during preheating. Always weight down the greaseproof paper with a dish or a baking tin. Only cover the surface required with greaseproof paper. Greaseproof paper must not protrude over the accessories.

- Using the appliance for anything other than its intended purpose is dangerous and may cause damage.  
The following is not permitted: drying out food or clothing, heating slippers, grain or cereal pillows, sponges, damp cleaning cloths or similar.  
For example, heated slippers and grain or cereal pillows may catch fire, even several hours after they have been heated. The appliance must only be used for the preparation of food and drinks.
- Food may catch fire. Never heat food in heat-retaining packages.  
Do not leave food heating unattended in containers made of plastic, paper or other combustible materials.  
Do not select a microwave power or time setting that is higher than necessary. Follow the information provided in this instruction manual.  
Never use the microwave to dry food.  
Never defrost or heat food with a low water content, e.g. bread, at too high a microwave power or for too long.
- Cooking oil may catch fire. Never use the microwave to heat cooking oil on its own.
- The appliance becomes very hot. If the appliance is installed in a fitted unit with a decorative door, heat will accumulate when the decorative door is closed. Only operate the appliance when the decorative door is open.

### **Risk of explosion!**

Liquids and other food may explode when in containers that have been tightly sealed. Never heat liquids or other food in containers that have been tightly sealed.

### **Risk of serious damage to health!**

- The surface of the appliance may become damaged if it is not cleaned properly. Microwave energy may escape. Clean the appliance on a regular basis, and remove any food residue immediately. Always keep the cooking compartment, door seal,

door and door stop clean; see also section *Care and cleaning*.

- Microwave energy may escape if the cooking compartment door or the door seal is damaged. Never use the appliance if the cooking compartment door or the door seal is damaged. Contact the after-sales service.
- Microwave energy will escape from appliances that do not have any casing. Never remove the casing. For any maintenance or repair work, contact the after-sales service.
- Preparing dishes in the microwave without using a wire rack leads to overloading of the appliance. The glass cover may break. Always use a wire rack and appropriate accessories to prepare dishes.

### **Risk of electric shock!**

- Incorrect repairs are dangerous. Repairs may only be carried out and damaged power cables replaced by one of our trained after-sales technicians. If the appliance is defective, unplug the appliance from the mains or switch off the circuit breaker in the fuse box. Contact the after-sales service.
- The cable insulation on electrical appliances may melt when touching hot parts of the appliance. Never bring electrical appliance cables into contact with hot parts of the appliance.
- Do not use any high-pressure cleaners or steam cleaners, which can result in an electric shock.
- When replacing the cooking compartment bulb, the bulb socket contacts are live. Before replacing the bulb, unplug the appliance from the mains or switch off the circuit breaker in the fuse box.
- A defective appliance may cause electric shock. Never switch on a defective appliance. Unplug the appliance from the mains or switch off the circuit breaker in the fuse box. Contact the after-sales service.
- The appliance is a high-voltage appliance. Never remove the casing.
- The insulation of an incompatible meat thermometer may be damaged. Only use the meat thermometer which is recommended for this appliance.

### **Risk of burns!**

- The appliance becomes very hot. Never touch the interior surfaces of the cooking compartment or the heating elements. Always allow the appliance to cool down. Keep children at a safe distance.
- Accessories and ovenware become very hot. Always use oven gloves to remove accessories or ovenware from the cooking compartment.
- Alcoholic vapours may catch fire in the hot cooking compartment. Never prepare food containing large quantities of drinks with a high alcohol content. Only use small quantities of drinks with a high alcohol content. Open the appliance door with care.
- Foods with peel or skin may burst or explode during, or even after, heating. Never cook eggs in their shells or reheat hard-boiled eggs. Never cook shellfish or crustaceans. Always prick the yolk when baking or poaching eggs. The skin of foods that have a peel or skin, such as apples, tomatoes, potatoes and sausages, may burst. Before heating, prick the peel or skin.
- Heat is not distributed evenly through baby food. Never heat baby food in closed containers. Always remove the lid or teat. Stir or shake well after the food has been heated. Check the temperature of the food before it is given to the child.
- Heated food gives off heat. The ovenware may become hot. Always use oven gloves to remove ovenware or accessories from the cooking compartment.
- Airtight packaging may burst when food is heated. Always observe the instructions on the packaging. Always use oven gloves to remove dishes from the cooking compartment.

### **Risk of scalding!**

- When you open the appliance door, hot steam may escape. Open the appliance door with care. Keep children at a safe distance.
- Water in a hot cooking compartment may create hot steam. Never pour water into the hot cooking compartment.
- There is a possibility of delayed boiling when a liquid is heated. This means that the liquid reaches boiling temperature without the usual steam bubbles rising to the surface. Even if the container only vibrates a little, the hot liquid may suddenly boil

over and spatter. When heating, always place a spoon in the container. This will prevent delayed boiling.

### Risk of injury!

- Scratched glass in the appliance door may develop into a crack. Do not use a glass scraper, sharp or abrasive cleaning aids or detergents.
- Unsuitable ovenware may crack. Porcelain or ceramic ovenware can have small perforations in the handles or lids. These perforations conceal a cavity below. Any moisture that penetrates this cavity could cause the ovenware to crack. Only use microwave-safe ovenware.

### Causes of damage

#### Caution!

- Creation of sparks: Metal - e.g. a spoon in a glass - must be kept at least 2 cm from the oven walls and the inside of the door. Sparks could irreparably damage the glass on the inside of the door.
- Baking tray, greaseproof paper, aluminium foil or ovenware on the cooking compartment floor: Do not place baking trays or ovenware on the cooking compartment floor. Do not line the cooking compartment floor with aluminium foil. This will cause heat accumulation. The baking and roasting times will no longer be correct and the enamel will be damaged.
- Foil containers: Do not use foil containers in the appliance. They damage the appliance by producing sparks.
- Water in the hot cooking compartment: Never pour water into the hot cooking compartment. This will cause steam. The temperature change can cause damage to the enamel.
- Moist food: Do not store moist food in the closed cooking compartment for long periods. This will damage the enamel. Do not use the appliance to store food. This can lead to corrosion.
- Fruit juice: When cooking very moist fruit flans, do not fill the universal pan too generously. Fruit juice which runs out of the universal pan leaves behind stains which cannot be removed.
- Cooling with the appliance door open: Only leave the cooking compartment to cool with the door closed. Do not trap anything in the appliance door. Even if the door is only slightly ajar, the fronts of adjacent units may be damaged over time.
- Condensation in the cooking compartment: Condensation may appear on the door window, interior walls and floor. This is normal and does not adversely affect microwave operation. To prevent corrosion, wipe off the condensation every time you cook.
- Heavily soiled seal: If the seal is very dirty, the appliance door will no longer close properly during operation. The fronts of adjacent units could be damaged. Always keep the seal clean.
- Using the appliance door for standing on or placing objects on: Do not stand or place anything on the open appliance door. Do not place ovenware or accessories on the appliance door.
- Transporting the appliance: Do not carry or hold the appliance by the door handle. The door handle cannot support the weight of the appliance and could break.
- Operating the microwave without food: Operating the appliance without food in the cooking compartment may lead to overloading. Never switch on the appliance unless there is food in the cooking compartment. An exception to this rule is

a short crockery test (see the section "Microwave, suitable crockery").

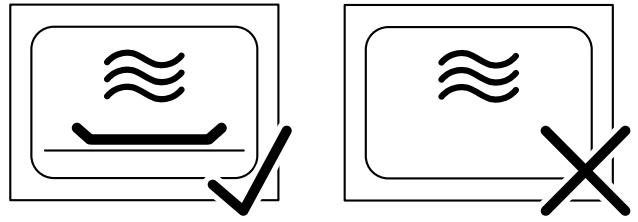

- Microwave popcorn: Never set the microwave power too high. Use a power setting no higher than 600 watts. Always place the popcorn bag on a glass plate. The disc may jump if overloaded.

# Your new appliance

Use this section to familiarise yourself with your new appliance. The control panel and the individual operating controls are

explained. You will find information on the cooking compartment and the accessories.

## Control panel

Here, you will see an overview of the control panel. Depending on the appliance model, individual details may differ.

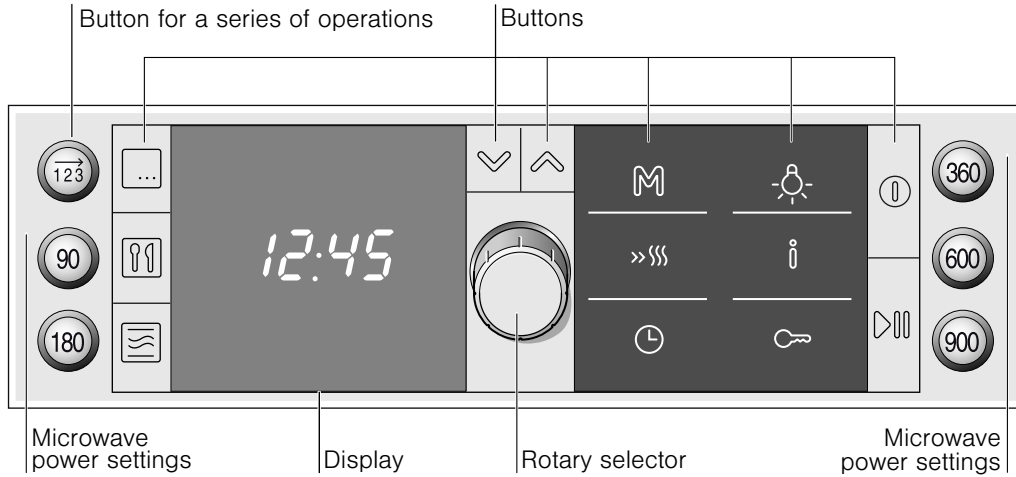

### Buttons

The sensors are located under the individual buttons. They must not be pressed too firmly. Only touch the corresponding symbol.

Exception: the button for the series of operations and the buttons for the microwave power settings are normal push buttons.

### Buttons

Symbol	Button function
→ 123	Selects a series of operations
90	Selects 90 watt microwave power
180	Selects microwave power 180 watt
360	Selects microwave power 360 watt
600	Selects 600 watt microwave power
900	Selects 900 watt microwave power
☐	Selects the type of heating
☐☐	Selects automatic programmes
☐☐☐	Selects MicroCombi
∨	Moves one row down in the display
∧	Moves one row up in the display
M	Selects the memory
»»»	Switches on rapid heating
⌚	Opens and closes the time-setting options menu
☼	Switches the oven light on and off
i	Press briefly = calls up information Press and hold = opens and closes the basic settings menu
🔑	Activates/deactivates childproof lock
Ⓜ	Switches the oven on and off
▶▶	Press briefly = starts/pauses operation Press and hold = cancels operation

### Rotary selector

☞ The rotary selector is used to alter the default values and setting values.

The rotary selector is retractable. Press on the rotary selector to pop it in or out.

### Display

The display is divided into different sections:

- Heading, only appears prior to starting
- Settings area
- Status bar

### Heading

The function selected is shown in the top line, e.g. types of heating, programmes, time-setting options, etc.. To the right of this, arrows indicate the direction in which you can navigate using the ∨ and ∧ buttons. The heading disappears after starting.

### Settings area

Suggested values appear in the settings range, which you can change. You can change from one line to the next using the ∨ and ∧ navigation buttons. Brackets are displayed around the line you are currently in. You can use the rotary selector to change the value in the brackets.

### Status bar

The status bar is at the bottom of the display. It displays the current time, time-setting options which are running down or the childproof lock setting. You are given short instruction texts on setting if required.

### Temperature indicator

The temperature indicator bars show the heating phases or residual heat in the cooking compartment.

## Heating indicator

The heating indicator displays the rising temperature in the cooking compartment. When all bars are filled, the optimum time for placing the dish in the oven has been reached.

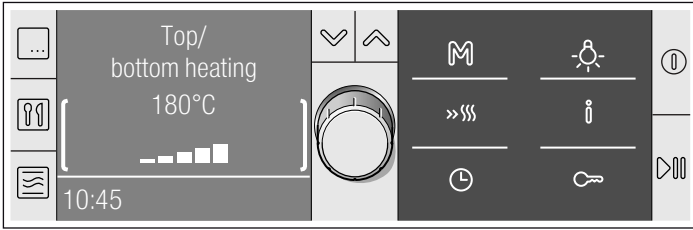

The bars do not appear when grill settings or the microwave are used.

You can use the **i** button to check the current heating temperature while the oven is heating up. Due to thermal inertia, the temperature displayed may differ slightly from the actual temperature in the cooking compartment.

## Residual heat

The temperature indicator shows the residual heat in the cooking compartment when the appliance is switched off. The cooking compartment has reached the maximum temperature when the last bar is full. Once the temperature has dropped to approximately 60 °C, the display goes out.

# Your accessories

The accessories supplied with your appliance are suitable for making many meals. Ensure that you always insert the accessories into the cooking compartment the right way round.

There is also a selection of optional accessories, with which you can improve on some of your favourite dishes, or simply to make working with your oven more convenient.

## Inserting accessories

You can insert the accessories into the cooking compartment at 3 different positions.

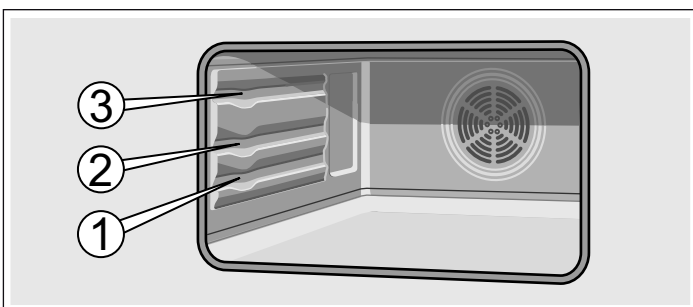

### Notes

- The accessories can be pulled out approximately halfway without tipping. This allows dishes to be removed easily.
- When sliding in the accessories, ensure that the projection on the wire rack and on the universal pan is at the back.

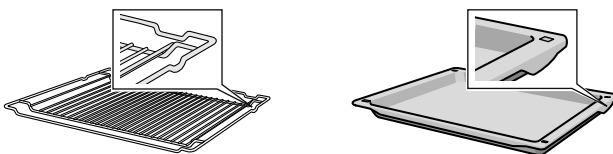

- The accessories can become deformed when they become hot. As soon as they have cooled down, the deformation disappears with no effect on the function.

## Cooking compartment

Your appliance has a cooling fan.

### Cooling fan

The cooling fan switches on and off as required. The hot air escapes above the door.

### Caution!

do not cover the ventilation slots. Otherwise the oven will overheat.

### Notes

- The cooling fan continues to run for a certain time after operation.
- The appliance remains cool during microwave operation. The cooling fan will still switch on. The fan may run on even when microwave operation has ended.
- Condensation may appear on the door window, interior walls and floor. This is normal and does not adversely affect microwave operation. Wipe away the condensation after cooking.

### Oven light

During operation, the oven light in the cooking compartment is on.

The oven light switches on when you open the oven door.

You can use the **☼** button to switch the light on and off.

You can buy accessories from the after-sales service, from specialist retailers or online. Please specify the HEZ number.

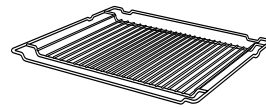

### Wire rack

For cookware made from glass, porcelain or microwave-safe plastic, cake tins, roasts and grilled food.

### Notes

- Insert the wire rack into the cooking compartment with the projection at the back.
- Insert the wire rack with the open side facing the cooking compartment door and the elbow rail pointing downwards .
- Always insert the wire rack at level 1 for cooking in microwave mode.

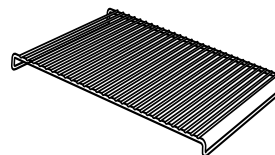

### Wire rack

For grilled meals. Always place the wire rack in the universal pan. This ensures that dripping fat and meat juices are collected.



### Universal pan HEZ862000

For large joints, dry and moist cakes, bakes and gratins. It can also act as a splash guard if you are grilling meat directly on the wire rack. For this, slide the universal pan in at position 1.

### Notes

- Insert the universal pan into the cooking compartment with the projection at the back.
- Slide the universal pan into the oven with the tapered edge facing the cooking compartment door.



## Optional accessories

You can purchase optional accessories from the after-sales service or specialist retailers. You will find a comprehensive range of products for your oven in our brochures and on the Internet. The availability of optional accessories and the option for ordering these online varies from country to country. Please check the sales brochures.

Optional accessories	HEZ number	Use
Enamel baking tray	HEZ861000	For cakes and biscuits. Slide the baking tray as far as possible into the oven with the tapered edge facing the cooking compartment door.
Glass roasting dish	HEZ915001	For stews and bakes that you prepare in the oven. It is particularly suitable for the automatic programmes.

## After-sales service products

You can obtain suitable care and cleaning agents and other accessories for your domestic appliances from the after-sales

service, specialist retailers or (in some countries) online via the e-Shop. Please specify the relevant product number.

Cleaning cloths for stainless-steel surfaces	Product no. 311134	Reduces the build-up of dirt. Impregnated with a special oil for perfect maintenance of your appliance's stainless-steel surfaces.
Oven and grill cleaning gel	Product no. 463582	For cleaning the cooking compartment. The gel is odourless.
Microfibre cloth with honeycomb structure	Product no. 460770	Especially suitable for cleaning delicate surfaces, such as glass, glass ceramic, stainless steel or aluminium. The microfibre cloth removes liquid and grease deposits in one go.
Door lock	Product no. 612594	To prevent children from opening the oven door. The locks on different types of appliance door are screwed in differently. See the information sheet supplied with the door lock.

## Before using the appliance for the first time

This section tells you everything you need to do before using the appliance for the first time.

- Set the clock
- Change the language for the text display if required
- Heat up the cooking compartment
- Clean the accessories
- Read the safety information at the start of the instructions for use. This is very important.

### Initial setup

Once your new appliance has been connected to the power supply, the "Basic settings" heading appears in the top line of the display. Set the clock, and also the text display language, if required. German is the default language.

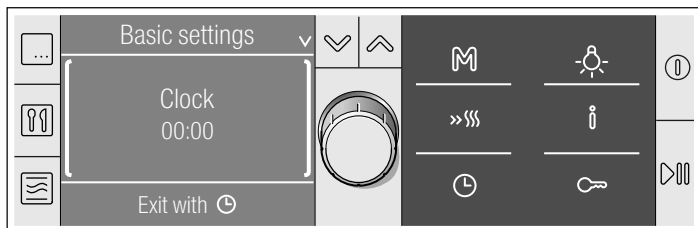

### Setting the clock and changing the language

1. Turn the rotary selector to set the current time.
2. Press the ✓ button.  
"Sprache wählen: deutsch" appears.
3. Select the desired language using the rotary selector.  
30 different languages are available.
4. Press the ⏸ button.

The language and time are applied. The current time is shown in the display.

**Note:** You can change the language at any time. See the *Basic settings* section.

### Heating up the cooking compartment

To get rid of the new appliance smell, heat up the cooking compartment when it is empty and the oven door closed.

Make sure that the cooking compartment contains no leftover packaging, e.g. polystyrene pellets.

Keep the kitchen ventilated the whole time the oven is on.

Heat up the cooking compartment to 240 °C using Top/bottom heating.

1. Press the ⏸ button.

The initial display including descriptions of the buttons appears.

2. Immediately press the ☐ button.

The heading "Types of heating" appears in the top line. 3D hot air and a temperature of 160 °C are suggested in the settings area. Brackets appear around the type of heating.

3. Turn the rotary selector to change the type of heating to Top/bottom heating.

4. Press the ✓ button to switch to the temperature.

The brackets now appear around the temperature.

5. Use the rotary selector to set 240 °C.

6. Press the ▶ button.

Operation starts. The "Types of heating" heading disappears.

7. Switch the oven off after 60 minutes using the ⏸ button.

The temperature indicator bars show the residual heat in the cooking compartment.

### Cleaning the accessories

Before you use the accessories for the first time, clean them thoroughly with hot soapy water and a soft dish cloth.

# Switching the oven on and off



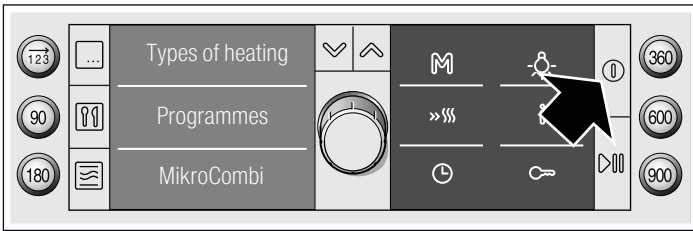

You can switch the oven on and off with the  button.

## Switching on

Press the  button. The initial display with the description of the buttons appears.



### Select the function you require:

- 90, 180, 360, 600 or 900 W button = microwave
-  button = types of heating
-  button = programmes
-  button = MicroCombi
-  button = series of operations
-  button = saved memory settings

If you do not select an operating mode in the next few seconds, the heading “Select function” appears.

A detailed description of how to make settings is provided in the individual sections.

## Switching off

Press the  button. The oven switches off.

# Setting the oven

In this section, you will find information about

- which types of heating are available in your oven
- how you set a type of heating and a temperature
- how you select a dish from the recommended settings
- and how you set rapid heating



## Types of heating

A large number of types of heating are available for your oven. You can therefore select the best method for preparing any meal.

Types of heating and temperature ranges	Application
3D hot air 30-250 °C	For baking cakes and small baked items on two levels.
Hot air 30-250 °C	For baking sponge cakes in baking tins on one level.
Top/bottom heating 30-270 °C	For baking and roasting on one level. Especially suitable for cakes with moist toppings (e.g. cheesecake) or for cakes on a baking sheet.
Intensive heat 100-270 °C	For recipes with a crispy base (e.g. quiche). The heat is emitted from above and more intensively from below.
Bottom heating 30-200 °C	For food and baked goods which should form a crust or which need more browning on the underside. Only switch on the Bottom heating for a short time at the end.
Hot air grilling 100-250 °C	For poultry and larger pieces of meat.
Grill, large area low (1) medium (2) high (3)	For grilling steaks, sausages, bread or fish in large quantities.
Grill, small area low (1) medium (2) high (3)	For grilling steaks, sausages, bread or fish in small quantities.

Types of heating and temperature ranges	Application
Slow cooking 70-100 °C	For tender pieces of meat, that are to be cooked medium, medium rare or “à point”.
Plate warming 30-70 °C	For warming porcelain tableware.
Keep warm 60-100 °C	For keeping food warm.

## Setting the type of heating and temperature

Switch on the oven with the  button and press the  button. 3D hot air and 180 °C are suggested in the display.

You can apply this setting immediately with the  button.

Example in the picture: Top/bottom heating setting, 200 °C

If you would like to set a different type of heating and temperature, proceed as follows:

1. Turn the rotary selector to set the desired type of heating.

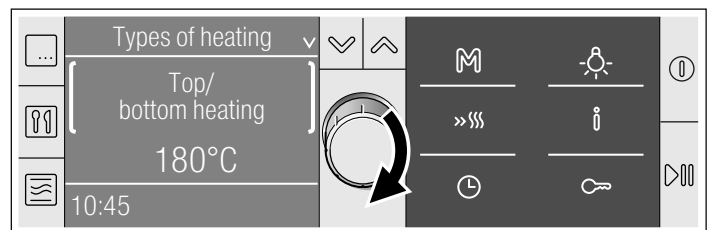

2. Press the  button to switch to the temperature.

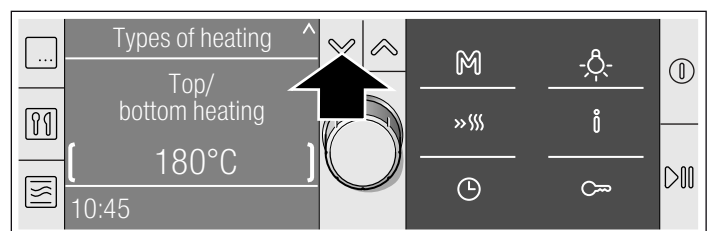

3. Turn the rotary selector to set the desired temperature.

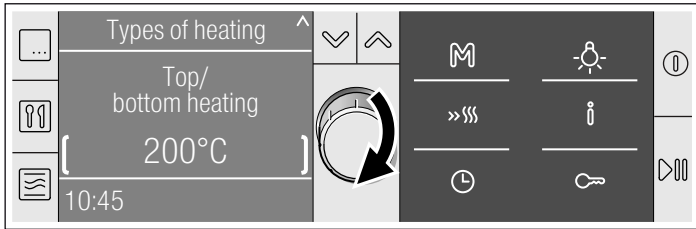

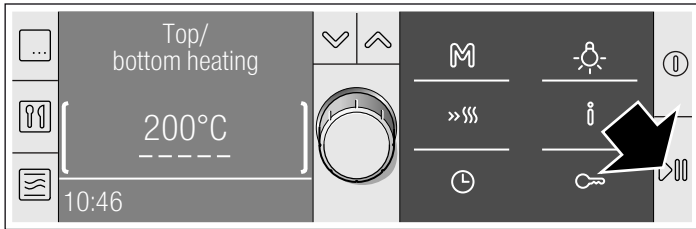

4. Press the  button.  
Appliance operation begins.





When the food is ready, switch the oven off with the  button or select and apply a new operating mode.

#### Opening the oven door during cooking

Operation is suspended. The oven is paused. The  symbol flashes on the status bar. Close the door and press the  button again. The programme will then continue.

#### Pausing operation

Press the  button briefly. The oven is paused. The symbol  flashes. Press the  button again, operation continues.



#### Changing the temperature or grill setting

This can be done at any time. Turn the rotary selector to change the temperature or grill setting.

#### Cancelling operation

Press and hold the  button until the intervention display appears. You can now change the settings.

#### Calling up information

Press the  button briefly. The first item of information appears. Check each further item of information using the  rotary selector. You will find information on the heating temperature, types of heating, shelf position and accessories.

#### Setting the cooking time

See section *Time-setting options*, setting the cooking time.

#### Setting a later end time

See the section entitled *Time-setting options*, Setting a later end time.

### Recommended settings

If you choose a dish from the recommended settings, the ideal setting values are already specified. You can choose from many different categories. You will find recommended settings for a large number of dishes – from cake, bread, poultry, fish, meat and game through to bakes and pre-prepared products. You can change the temperature and cooking time. The type of heating is fixed.

You can access the various dishes by navigating through several selection levels. Try it out and see the range of dishes for yourself.

#### Selecting a dish

1. Press the  button.  
3D hot air, 160 °C are suggested in the display.

2. Turn the rotary selector anticlockwise to Recommended settings.

The first food category appears.

3. Press the  button to switch to the food category and select the required category by turning the rotary selector.

Use the  button to switch successively to the next level. Turn the rotary selector to find the next selection.

The setting for the selected dish now appears. You can change the temperature, but not the type of heating.

4. Press the  button.

Operation starts. The cooking time is shown counting down in the status bar.



#### The cooking time has elapsed

A signal sounds. The oven stops heating. The status bar shows 00:00:00. You can cancel the signal early by pressing the  button.

#### Changing the temperature or grill setting

Turn the rotary selector to change the temperature or grill setting.

#### Changing the cooking time

Press the  button and turn the rotary selector to change the cooking time. Press the  button.

#### Calling up information

Press the  button and check the information using the rotary selector.

#### Setting a later end time

See the section entitled *Time-setting options*, Setting a later end time.

### Setting rapid heating

Rapid heating is not suitable for all types of heating.



#### Suitable types of heating

- 3D hot air
- Hot air
- Top/bottom heating
- Intensive heat

#### Suitable temperatures

Rapid heating will not work if the temperature is set to less than 100 °C. If the temperature in the cooking compartment is only slightly less than the temperature you have set, rapid heating is not necessary. It will not switch on.

#### Setting rapid heating

Press the  button to activate rapid heating. The  symbol appears next to the temperature you have set. The temperature indicator bars start filling in.

Once all the bars are filled, rapid heating is complete. You will hear a short signal. The  symbol goes out. Place your dish in the cooking compartment.

#### Notes

- Rapid heating is cancelled if you change the type of heating.
- If a cooking time has been set, this runs independently of rapid heating and counts down immediately when operation is started.
- You can use the  button to check the current cooking compartment temperature during rapid heating.
- To ensure an even cooking result, do not place your dish in the cooking compartment until rapid heating is complete.

#### Cancelling rapid heating

Press the  button. The symbol goes out.

# The microwave

Microwaves are converted to heat in food. The microwave can be used solo, i.e. on its own, or in combination with a different type of heating. Here you will find information about cookware and how to set the microwave.

## Notes

- In the *Tested for you in our cooking studio* section, you will find examples for defrosting, heating and cooking with the microwave.
- Always use a wire rack and appropriate accessories to prepare dishes.

## Notes regarding ovenware

### Suitable ovenware

Suitable dishes are heat-resistant ovenware made of glass, glass ceramic, porcelain, ceramic or heat-resistant plastic. These materials allow microwaves to pass through.

You can also use serving dishes. This saves you having to transfer food from one dish to another. You should only use ovenware with decorative gold or silver trim if the manufacturer guarantees that they are suitable for use in microwaves.

### Unsuitable ovenware

Metal ovenware is unsuitable. Metal does not allow microwaves to pass through. Food in covered metal containers will remain cold.

### Caution!

Creation of sparks: metal – e.g. a spoon in a glass – must be kept at least 2 cm from the oven walls and the inside of the door. Sparks could destroy the glass on the inside of the door.

### Cookware test

Do not switch on the microwave unless there is food inside. The following cookware test is the only exception to this rule.

Perform the following test if you are unsure whether your cookware is suitable for use in the microwave:

1. Heat the empty cookware at maximum power for ½ to 1 minute on the wire rack at level 1.
2. Check the temperature during that time.

The cookware should be cold or warm to the touch.

The cookware is unsuitable if it becomes hot or sparks are generated.

## Microwave power settings

Use the button to set the desired microwave power.

90 W	for defrosting delicate foods
180 W	for defrosting and continued cooking
360 W	for cooking meat and heating delicate foods
600 W	for heating and cooking food
900 watts	for heating liquids

## Notes

- When you press a button, the selected power lights up.
- The microwave power can be set to 900 watts for a maximum of 30 minutes. With all other power settings a maximum cooking time of 1 hour 30 minutes is possible.

## Setting the microwave

Example in diagram: microwave power setting 360 W, cooking time 17 minutes.

1. Press the button for the microwave power setting you require. The button lights up. The heading “Microwave” appears in the display. A suggested cooking time is displayed.

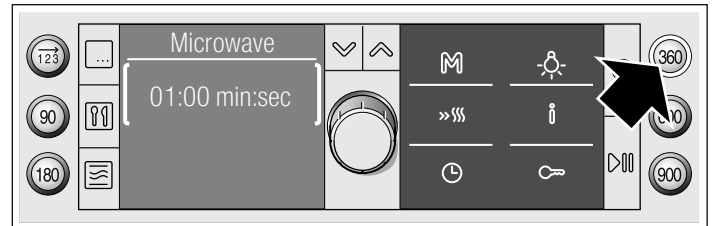

2. Set the cooking time using the rotary selector.

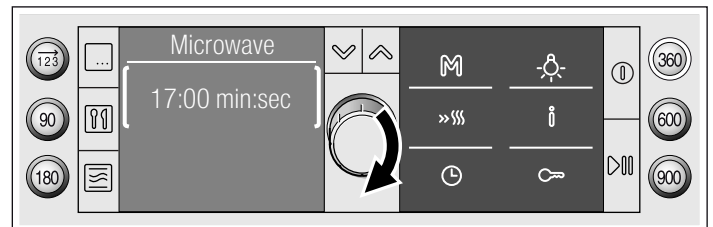

3. Press the >||| button.

Appliance operation begins. The cooking time starts counting down.

### The cooking time has elapsed

A signal sounds. Microwave operation has finished. The cooking time shows 00:00 min:sec. You can cancel the audible signal before it finishes sounding by pressing the ⏸ button.

### Opening the oven door during cooking

Operation is suspended. After closing the door, press the >||| button briefly. The programme will then continue.

### Pausing operation

Press the >||| button briefly. The oven is paused. The symbol >||| flashes. Press the >||| button again, operation continues.

### Changing the cooking time

This can be done at any time. Change the cooking time using the rotary selector.

### Cancelling operation

Press and hold the >||| button until the intervention display appears. You can now change the settings.

# MicroCombi

A microwave power setting is switched on automatically. You simply need to set the temperature specified in the recipe and halve the cooking time.

## MicroCombi, gentle

MicroCombi, gentle is suitable for cakes in tins, such as

- Sponge cake, e.g. marble cake, fruit loaf, fruit flan

- Short-crust pastry with moist filling, e.g. apple pie, cheesecake
- Cakes made from baking mixtures
- Yeast cake, e.g. with currants
- For roasting, the cooking time can also be halved with this type of heating.

**Note:** Use dark metal baking tins or else plastic "FlexiForm" bakeware. For joints, a heat-resistant glass dish with or without a lid is suitable.

## MicroCombi, intensive

This type of heating is suitable for

- poultry, e.g. chicken
- baked casseroles, e.g. pasta bake
- gratins, e.g. potato gratin
- grilled fish, fresh and frozen

**Note:** Use heat-resistant containers made of glass or ceramic.

## Setting MicroCombi

If there is information in the recipe for different types of heating, take the setting for Top/bottom heating. The cooking time specified in the recipe should not be less than 30 minutes.

Place your dish in the cold cooking compartment. Place the ovenware in the centre of the wire rack at level 1.

1. Press the  button.

The display suggests "MicroCombi, gentle", 180 °C. If you require "MicroCombi, intensive", turn the rotary selector. "MicroCombi, intensive, 200 °C" appears.

2. Use the  button to switch to the temperature and set the temperature using the rotary selector.

3. Press the  button and set a cooking time using the rotary selector.

A cooking time of 20:00 minutes is suggested.

4. Press the  button.

5. Start with the  button.

You can see the cooking time counting down in the status bar.

### The cooking time has elapsed

A signal sounds. Operation has finished. The status bar shows 00:00:00. You can cancel the signal before it has finished sounding by pressing the  button.

## Combination

This involves the simultaneous operation of one type of heating with the microwave. Using the microwave makes your meals ready more quickly, and they are still nicely browned. You can set a cooking time of up to 1 hour 30 minutes.

### Suitable types of heating

- 3D hot air
- Hot air
- Top/bottom heating
- Hot air grilling
- Grill, large area
- Grill, small area

### Suitable microwave power settings

Except for 900 watts, you can combine any microwave power setting with a heating type.

### Setting a combination

Example in diagram: Top/bottom heating setting 200 °C and microwave setting 360 W, 17 minutes.

1. Press the  button.

"Types of heating" appears as the heading. 3D hot air and 160 °C are suggested in the display.

2. Turn the rotary selector to set the desired type of heating.

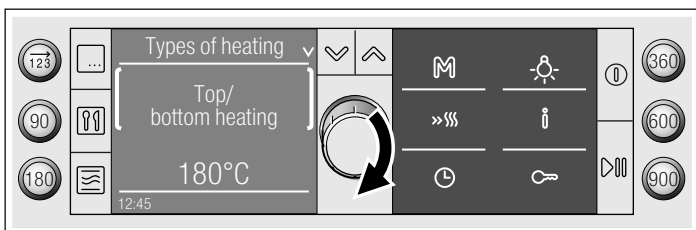

3. Press the  button to switch to the temperature.

4. Use the rotary selector to change the temperature.

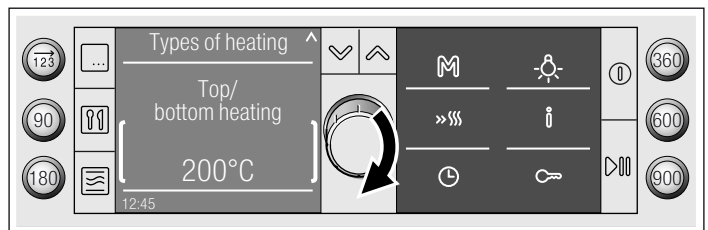

5. Press the button for the microwave power setting you require.

The selected button lights up. The heading changes to "Combination".

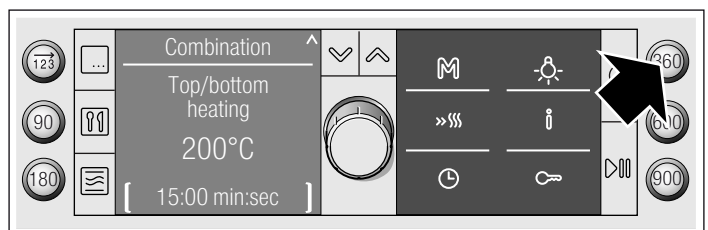

6. Set the cooking time using the rotary selector.

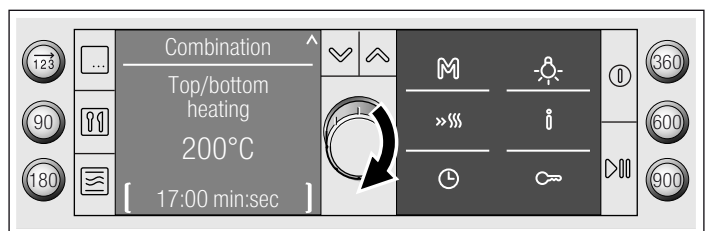

7. Press the ▷ button.

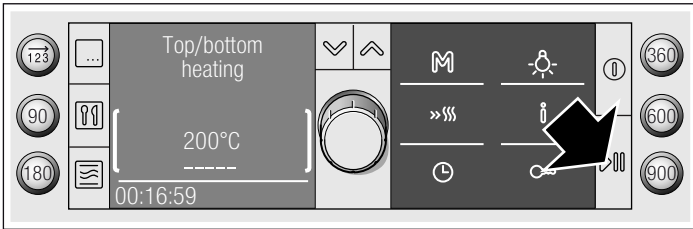

Appliance operation begins. You can see the cooking time counting down in the status bar.

#### The cooking time has elapsed

A signal sounds. Operation has finished. The status bar shows 00:00:00. You can cancel the signal before it has finished sounding by pressing the ⏸ button.

#### Changing the temperature or grill setting

This can be done at any time. Turn the rotary selector to change the temperature or grill setting.

#### Changing the cooking time

Press the ⏸ button and turn the rotary selector to change the cooking time. Press the ⏸ button.

#### Opening the oven door during cooking

Operation is suspended. The oven is paused. The ▷ button flashes on the status bar. Close the door and press the ▷ button again. The programme will then continue.

#### Pausing operation

Press the ▷ button briefly. The oven is paused. Press the ▷ button again to continue operation.

#### Cancelling operation

Press and hold the ▷ button until the intervention display appears. You can now change the settings.

#### Setting a later end time

See the section entitled *Time-setting options*, Setting a later end time.

## Series of operations

You can use the SeriesOperations function to set up to three operating modes and then start. Requirement: you must set a cooking time for each step.

### Ovenware

Always use microwave-safe, heat-resistant ovenware.

### Setting a series of operations

**Note:** Always set a cooking time for each step in the series of operations.

1. Press the 123 button.

The button lights up. "SeriesOperations 1" appears in the display as the heading.

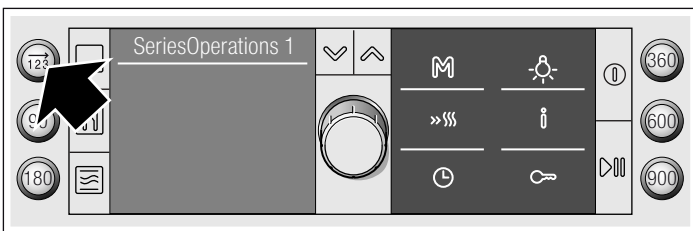

2. Select and set the desired operating mode.

3. Press the 123 button again in order to select the second operation in the series.

4. Select and set the desired operating mode.

5. Press the 123 button again in order to select the third operation in the series.

6. Select and set the desired operating mode.

7. Press the ▷ button.

Appliance operation begins.

**Note:** The first operation in the series is shown in the display. The cooking time starts counting down.

#### The cooking time has elapsed

A signal sounds. The series of operations is finished. You can stop the audible signal by pressing the ⏸ button.

#### Changing the setting

**Note:** Changes can only be made before operation begins.

1. Press the 123 button until operation 1, 2 or 3 in the series appears in the displays

2. Set the desired operation in the series with the rotary selector.

3. Press the ▷ button.

Appliance operation begins.

#### Cancelling operation

Press and hold the ▷ button until the intervention display appears. You can now change the settings.

## Time-setting options

You can call up the time-setting options menu by pressing the ⏸ button. The following functions are available:

If the oven is switched off:

- Setting the timer
- Setting the clock

If the oven is switched on:

- Setting the timer
- Setting the cooking time

- Setting a later end time

### Setting the cooking time

If you set the cooking time for your meal, operation stops automatically once this time has elapsed. The oven stops heating.

Prerequisite: The type of heating and temperature must be set.

**Note:** You can only set hours and minutes.

Example in diagram: Top/bottom heating, 180 °C, 45 minutes

1. Press the  button.

The time-setting options menu appears.

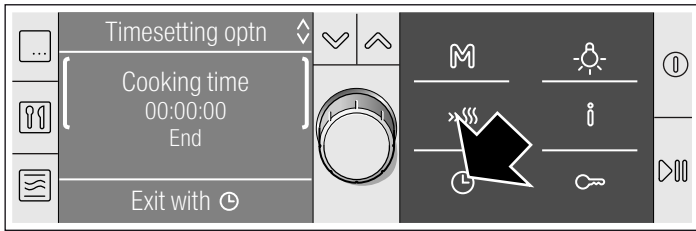

2. Turn the rotary selector to set the cooking time.

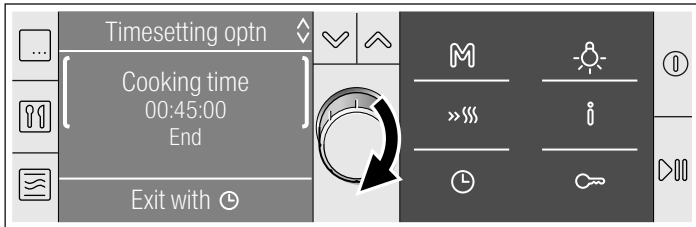

3. Press the  button.

The time-setting options menu closes.



4. If operation has not yet been started, press the  button.

You can see the cooking time counting down in the status bar.



### The cooking time has elapsed

A signal sounds. The oven stops heating. The status bar shows the cooking time as 00:00:00. You can cancel the signal early by pressing the  button.

### Cancelling the cooking time

Press the  button to open the menu. Set the cooking time to 00:00:00 using the rotary selector. Press the  button to close the menu.

### Changing the cooking time

Press the  button to open the menu. Change the cooking time using the rotary selector. Press the  button to close the menu.

### Setting a later end time

Please remember that easily spoiled foods must not be allowed to remain in the cooking compartment for too long.

Example: you put the food in the cooking compartment at 9:30 am. It takes 45 minutes to cook and will be ready at 10:15, but you would like it to be ready at 12:45 instead. Change the end time from 10:15 to 12:45. The oven goes into standby. Cooking starts at 12:00 and finishes at 12:45.

In some programmes, it is not possible to move the end time.

### Moving the end

Prerequisite: The selected operation has not already begun. A cooking time must be set. The time-setting options menu  is open.

1. Switch to "End" using the  button.

The time at which operation is ended is displayed in the second line.

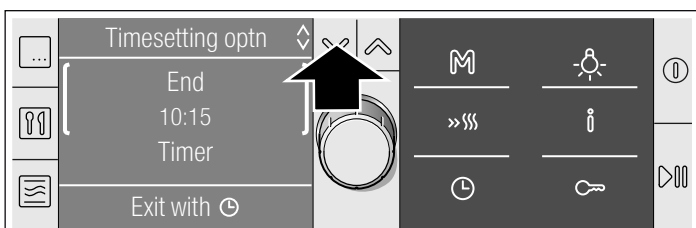

2. Set a later end time by turning the rotary selector.

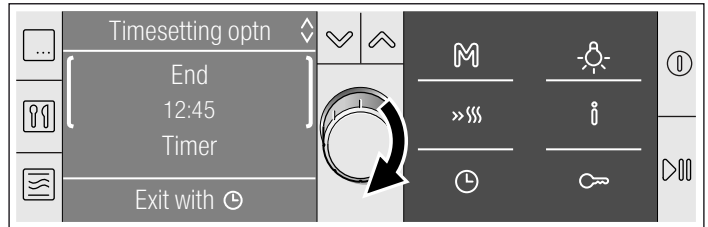

3. Press the  button to close the time-setting options menu.



4. Confirm by pressing the  button.

The setting is adopted. The oven is in ... standby. The end time is displayed in the status bar. When operation starts, the cooking time starts counting down in the status bar.



### The cooking time has elapsed

A signal sounds. The oven stops heating. The status bar shows the cooking time as 00:00:00. You can cancel the signal early by pressing the  button.

### Correcting the end time

This is possible while the oven is in standby. Press the  button to open the menu. Press the  button and correct the End time using the rotary selector. Press the  button to close the menu.

### Cancelling the end time

This is possible while the oven is in standby. Press the  button to open the menu. Press the  button and reset the End time using the rotary selector. Press the  button to close the menu.

### Setting the timer

The timer runs independently of the oven. You can use it as a kitchen timer and set it at any time.

1. Press the  button.



The time-setting options menu appears.

2. Set the running time for the timer using the rotary selector.



3. Press the  button to close the Time-setting options menu.

The display returns to its previous state. The  symbol for the timer appears, and the time can be seen counting down.



### When the time has elapsed

A signal sounds. The time has elapsed. The display shows  00:00. You can cancel the signal earlier by pressing the  button.

### Cancelling the timer time

Press the  button to open the time-setting options menu. Using the rotary selector, turn the time back to 00:00. Press the  button to close the menu.

### Changing the timer time

Press the  button to open the time-setting options menu. Use the rotary selector within the next few seconds to change the time on the timer. Press the  button to close the menu.

### Setting the clock

The oven must be switched off before you can set or change the clock.

### Following a power cut

Following a power cut, the "Basic settings" heading appears in the display.



1. Set the right time using the rotary selector.

2. Press the  button.

The time is applied.

## Changing the clock

Example: changing from summer to winter time.

1. Press the  button.  
The time-setting options menu appears.
2. Use the  button to switch to the clock.
3. Change the time using the rotary selector.

4. Press the  button.

The Time-setting options menu closes. The time is changed.

## Hiding the clock



The current time appears in the display when the oven is switched off. You can hide the clock. For more information, refer to the *Basic settings* section.

---

# Memory

Memory gives you the option to store your own settings and call them up again at the press of a button. There are six memory locations available. The memory function is useful for recipes which you prepare particularly frequently.

## Storing settings in the memory

1. Set the required operating mode. Do not start.
2. Press and release the  button and use the rotary selector to select one of the six memory locations.
3. Press and hold the  button until "Memory saved" is displayed.



The setting is saved and can be started at any time.

## Reallocating a memory location

Make the settings, select the memory location and save the new settings using the  button. The old settings are overwritten.

## Starting the memory

You can start the saved settings at any time.

1. Press and release the  button and use the rotary selector to select the memory location.  
The stored settings are displayed. If "Memory location empty" appears, this means that there are no settings stored as yet in this memory location.
2. Press the  button.  
The memory function starts.

## Changing the memory location

Once operation has started, you can no longer change the memory location.

## Changing the settings

This can be done at any time. The setting you originally saved appears the next time you start the memory.

---



# Sabbath mode



When this setting is used, the temperature of the oven remains at between 85 °C and 140 °C with Top/bottom heating. You can set a time between 24 and 73 hours.

You can keep dishes in the cooking compartment hot for this time without having to switch the oven on or off.

## Starting Sabbath mode

Prerequisite: "Sabbath mode, yes" is activated in the basic settings. See the *Basic settings* section.

1. Press the  button.  
3D hot air and 160 °C are suggested in the display.
2. Turn the rotary selector anti-clockwise to Sabbath mode.
3. Use the  button to switch to the temperature and set the desired temperature using the rotary selector.

4. Press the  button to open the time-setting options menu.  
27:00 hours are suggested.
5. Turn the rotary selector to set the required cooking time.
6. Press the  button.

The Sabbath mode starts. You can see the cooking time counting down in the status bar.

## The cooking time has elapsed

The oven stops heating.

## Setting a later end time

It is not possible to set a later end time.

## Cancelling Sabbath mode



Press and hold the  button until the intervention display appears. You can make new settings.

---

# Childproof lock

The oven has a childproof lock to prevent children from switching it on or changing a setting by accident.



## Activating the childproof lock

Press and hold the  key button until the  symbol appears. This takes about 4 seconds.

The control panel is locked.

## Releasing the lock

Press and hold the  button until the symbol disappears. You can make settings again.

**Note:** You can still switch the oven off, set the timer and switch the audible signal off when the childproof lock is active by pressing  or by pressing and holding the  button.



# Basic settings

Your appliance has various basic settings, which you can adjust to suit your needs at any time.

**Note:** In the table, you will find all the basic settings and options for changing them. Only the basic settings that correspond to the features of your specific appliance are displayed.

Basic setting	Options	Explanation
Select language: English	29 additional languages are available	Language for display texts.
Signal duration: medium	medium = 2 minutes short = 10 seconds long = 5 minutes	Duration of the audible signal once a cooking time has elapsed.
Button tone*: off	on off	Confirmation tone when a button is pressed. *Exception: A signal always sounds when you switch the oven on and off.
Display brightness: medium	day medium night	Display lighting
Contrast: - ○○○●○○○ +	e.g. greater - ○○○○○●○ +	Display contrast
Clock display: on	on off*	How the clock is displayed when the oven is switched off *The time appears as long as the residual heat will be displayed.
Continue when door shut: Continue with 	automatic	Way in which operation is continued when the oven door is opened and closed again
Adjust individually: - ○○○●○○○ +	e.g. increasingly well done cooking result - ○○○○○●○ +	Change the cooking result for all automatic programmes to the right = more intensive to the left = less intensive
Display button description: on	on off	The initial display appears when the oven is switched on.
3D hot air Suggestion: 160 °C	from 30 to max. 250 °C	Permanently change default temperature for the type of heating.
Hot air Suggestion: 160 °C	from 30 to max. 250 °C	Permanently change default temperature for the type of heating.
Top/bottom heating Suggestion: 180 °C	from 30 to max. 270 °C	Permanently change default temperature for the type of heating.
HydroBaking Suggestion: 160 °C	from 30 to max. 270 °C	Permanently change default temperature for the type of heating.
Intensive heat Suggestion: 190 °C	from 100 to max. 270 °C	Permanently change default temperature for the type of heating.
Bottom heating Suggestion: 180 °C	from 30 to max. 200 °C	Permanently change default temperature for the type of heating.
Hot air grilling Suggestion: 190 °C	from 100 to max. 250 °C	Permanently change default temperature for the type of heating.
Grill, large area Suggestion: 3	3 (high) 2 (medium) 1 (low)	Permanently change default setting for the type of heating.
Grill, small area Suggestion: 3	3 (high) 2 (medium) 1 (low)	Permanently change default setting for the type of heating.
Slow cooking Suggestion: 80 °C	from 70 to max. 100 °C	Permanently change default temperature for the type of heating.
Plate warming Suggestion: 50 °C	from 30 to max. 70 °C	Permanently change default temperature for the type of heating.
Keep warm Suggestion: 70 °C	from 60 to max. 100 °C	Permanently change default temperature for the type of heating.
Sabbath mode: no	no yes	See the <i>section Sabbath mode</i>
Operating voltage 220-230V	220-230V 230-240V	Adjusting the operating voltage

Basic setting	Options	Explanation
Restore factory settings: no	no yes	Reverse all changes and restore basic settings.

## Changing the basic settings

Prerequisite: The oven must be switched off.

Example: Changing the acoustic signal duration basic setting from medium to short.

1. Press and hold the **i** button for approx. 4 seconds until the "Basic settings" heading and the first basic setting "Select language: English" appears.
2. Turn the **✓** button to select the required basic setting.

3. You can change the basic setting by turning the rotary selector.
4. You can now make further changes to the basic settings. To do so, use the **↖** or **↘** button to switch to the desired setting. Change the basic setting by turning the rotary selector.
5. Press and hold the **i** button until the clock appears. This takes about four seconds. All changes are saved.

### Cancelling

Press the **ⓘ** button. The changes are not applied.

## Automatic switch-off

Your oven has an automatic switch-off function. It is activated if no cooking time is set and the settings have not been changed for a long time. The point at which this occurs depends on the temperature or grill setting that has been set.

### Switch-off activated

"Automatic switch-off" appears in the display. Operation is

interrupted. Press any button to clear the text. You can make new settings.

**Note:** If a cooking time is set, the oven stops heating once the cooking time has elapsed. The automatic switch-off function is not necessary.

## Care and cleaning

With careful care and cleaning your microwave oven will retain its looks and remain good order. We will explain here how you should care for and clean your appliance correctly.

### ⚠ Risk of electric shock!

Do not use any high-pressure cleaners or steam cleaners, which can result in an electric shock.

### ⚠ Risk of burns!

The appliance becomes very hot. Never touch the interior surfaces of the cooking compartment or the heating elements. Always allow the appliance to cool down. Keep children at a safe distance.

### Notes

- Slight differences in colour on the front of the appliance are caused by the use of different materials, such as glass, plastic and metal.
- Shadows on the door panel which look like streaks, are caused by reflections made by the oven light.
- Enamel is baked on at very high temperatures. This can cause some slight colour variations. This is normal and does not affect their function. The edges of thin trays cannot be completely enamelled. As a result, these edges can be rough. This will not impair the anti-corrosion protection.
- Unpleasant odours, e.g. after fish has been prepared, can be removed very easily. Add a few drops of lemon juice to a cup of water. Place a spoon into the container as well, to prevent delayed boiling. Heat the water for 1 to 2 minutes at maximum microwave power.

## Cleaning agents

To ensure that the different surfaces are not damaged by using the wrong cleaning agent, observe the information in the table. Do not use

- sharp or abrasive cleaning agents,

- metal or glass scrapers to clean the glass in the appliance door,
- metal or glass scrapers to clean the door seal,
- hard scouring pads and sponges,
- cleaning agents with high concentrations of alcohol.

Wash new sponge cloths thoroughly before use.

Area	Cleaning agents
Control panel	Hot soapy water: Clean with a dish cloth and dry with a soft cloth. Do not use glass cleaners or metal or glass scrapers for cleaning.
Stainless steel	Hot soapy water: Clean with a dish cloth and dry with a soft cloth. Remove flecks of limescale, grease, starch and albumin (e.g. egg white) immediately. Corrosion can form under such residues. Special stainless steel cleaning agents can be obtained from the after-sales service or from specialist shops.
Oven	Hot soapy water or a vinegar solution: Clean with a dish cloth and dry with a soft cloth. If oven is very dirty: use oven cleaner, but only when oven is cold. It is best to use a stainless-steel sponge.
Glass cover for the oven light	Hot soapy water: Clean with a dish cloth.
Outer door panel	Glass cleaner: Wipe dry immediately using a soft cloth. Do not use a glass scraper.
Inner door glass	Glass cleaner: Wipe dry with a soft cloth. Do not use a glass scraper.

Area	Cleaning agents
Seal	Hot soapy water: Clean with a dish cloth, do not scour. Do not use a metal or glass scraper for cleaning.
Accessories	Hot soapy water: Soak and clean with a dish cloth or a brush.

### Cleaning the self-cleaning surfaces in the cooking compartment

The back wall and ceiling are coated with self-cleaning enamel. They clean themselves while the oven is in operation. Sometimes, larger splashes of food may not disappear until the oven has been operated several times.

#### Notes

- Never treat the self-cleaning surfaces with oven cleaner. If oven cleaner accidentally gets onto the back wall or ceiling, remove it immediately with a sponge and plenty of water.
- Never use abrasive cleaning agents. You will scratch or destroy the highly porous coating.
- Never treat the self-cleaning surfaces with a scouring pad.
- Light discolouration of the enamel does not affect self-cleaning.

### Cleaning the cooking compartment floor and side walls

Use a dish cloth and hot soapy water or a vinegar solution.

If there are heavy deposits of dirt, use a stainless steel scouring pad or oven cleaner. Only use in a cold oven.

### Cleaning the glass cover

The glass cover can be removed from the oven ceiling for cleaning.

#### ⚠ Risk of burns!

Do not remove the panels immediately after switching the appliance off. The oven must be cold.

#### Removal

1. Place a tea towel in the oven.
2. Pull the clip on the oven ceiling forwards. (Fig. A)  
Press the front of the glass cover down using the thumb of your other hand. Let go of the clip.
3. Slide the cover forwards using both hands and rest it on the grill element. (Fig. B)

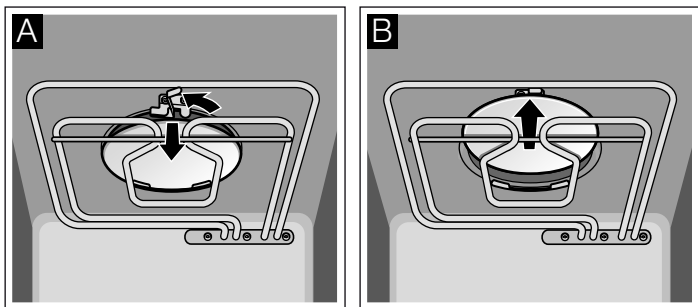

4. Slide it slightly backwards again. (Fig. C)

5. Tilt down at the side and remove. (Fig. D)

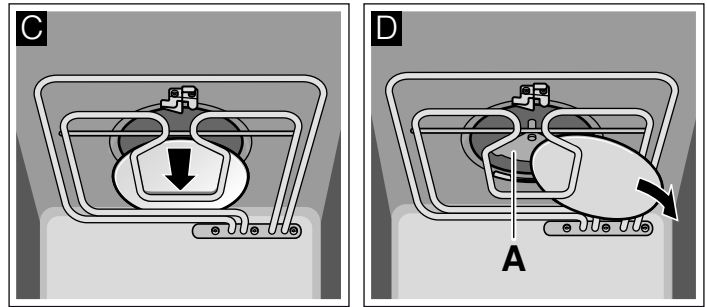

#### ⚠ Risk of injury!

Never touch or clean the microwave antenna (A)!

For light soiling:

Wash the glass cover using hot soapy water.

For heavy soiling:

Clean the glass cover in the same way as the enamel surfaces in the oven.

#### Refitting

1. Slide in the cover with the smooth side facing downwards and rest it on the grill element. (Fig. A)
2. Use both hands to slide it back into the two catches. (Fig. B).

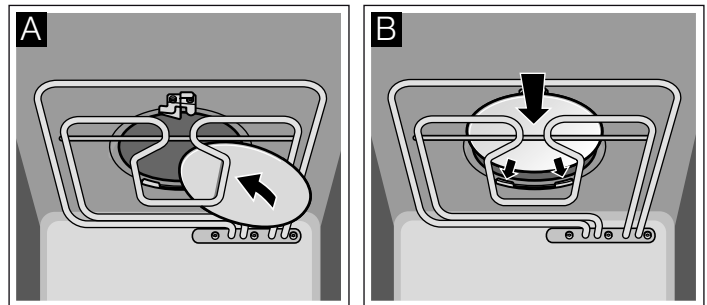

3. Pull the clip forwards and push the glass cover upwards. Let go of the clip. (Fig. C)

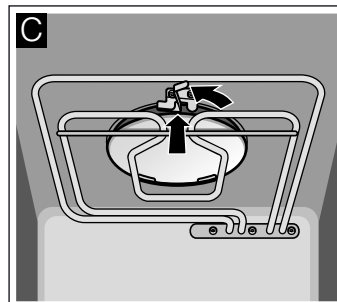

Remove the tea towel from the oven.

#### ⚠ Risk of serious damage to health!

Never operate the appliance without the microwave glass cover. Microwave energy may escape.

### Cleaning the glass panels

The glass panels can be removed from the oven door for cleaning.

#### ⚠ Risk of burns!

The appliance becomes very hot. Never touch the interior surfaces of the cooking compartment or the heating elements. Always allow the appliance to cool down. Keep children at a safe distance.

## Removal

1. Open the oven door.
2. Undo the two screws on the door using a TORX screwdriver (TORX 20). Hold the door panel firmly while doing this (Fig. A).
3. Position the door at an angle and pull out the panel upwards by the door handle. (Fig. B).

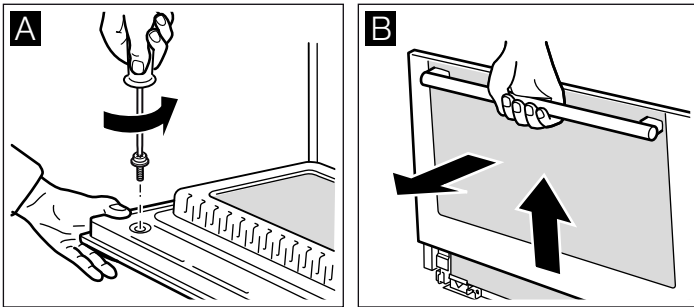

4. Close the door.

**Note:** Clean the glass panels with glass cleaner and a soft cloth.

### Risk of injury!

Scratched glass in the appliance door may develop into a crack. Do not use a glass scraper, sharp or abrasive cleaning aids or detergents.

## Refitting

1. Insert the door panel into the guide with both hands. (Fig. A).
2. Push the door panel downwards, lift it slightly and hook it in at the top (Fig. B).

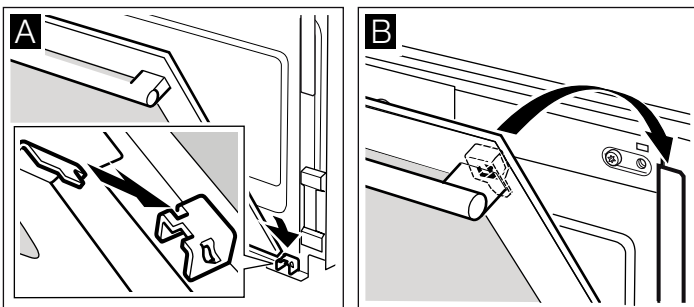

## Caution!

Make sure that the door panel is sitting flush with the control panel.

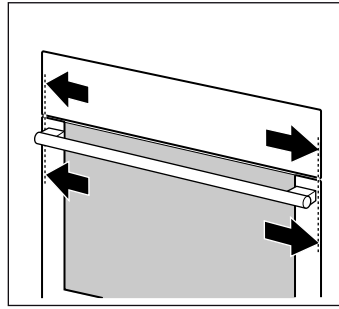

3. Fully open the door, while holding the panels firmly with one hand (Fig. C).
4. Push the door downwards again and tighten the screws hand-tight using a TORX screwdriver (TORX 20) and close the door. (Fig. D).

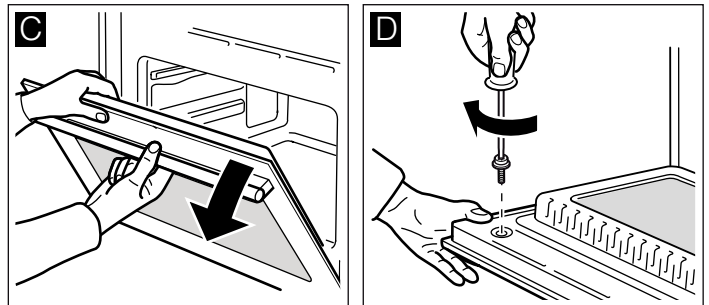

## Caution!

You must not use the oven again until the panels have been properly refitted.

# Malfunction table

Malfunctions often have simple explanations. Please refer to the malfunction table before calling the after-sales service.





If a meal does not turn out exactly as you wanted, refer to the *Tested for you in our cooking studio* section, where you will find plenty of cooking tips and tricks.

### Risk of electric shock!

Incorrect repairs are dangerous. Repairs may only be carried out by one of our trained after-sales engineers.

## Malfunction table

Problem	Possible cause	Remedy/information
The appliance does not work.	Faulty circuit breaker	Look in the fuse box and check that the circuit breaker is in working order.
	Plug not plugged in	Plug it in.
	Power cut	Check whether the kitchen light works.
"Basic setting Clock 00:00" appears in the display. The time displayed is not the current time.	Power cut	Turn the rotary selector to set the correct time, then press the  button.

Problem	Possible cause	Remedy/information
The oven does not heat up. When the appliance is switched on, "Demo" is displayed briefly.	The oven is in demo mode	Switch off the circuit breaker in the fuse box and then switch back on after approx. 20 seconds. In the next 2 minutes, press and hold the  button for 4 seconds.
"Automatic switch-off" appears in the display.	The automatic switch-off has been activated. The oven stops heating.	Press any button. The text disappears. You can make settings again.
The microwave does not switch on.	Door not fully closed.	Check whether food remains or foreign material is trapped in the door. Make sure that the sealing surfaces are clean. Check whether the door seal is twisted.
	The microwave was not started.	Press the  button.
The appliance does not heat up to the temperature which has been set.	The  button was not pressed.	Press the  button.
Microwave operation has been cancelled for no apparent reason.	The microwave has a fault.	If this fault occurs repeatedly, please call the after-sales service. Oven operation without microwave is possible.
With microwave operation, the food takes longer to heat up than before.	The microwave power setting is too low.	Select a higher power setting.
	A larger amount than usual has been placed in the appliance.	Double the amount = almost double the time
	The food was colder than usual.	Stir or turn the food during cooking

### Error messages with E

If an error message with E is shown in the display, press the  button. Then reset the clock. This cancels the error message. If the error is shown again, call the after-sales service. With error message E106, you can still operate the microwave.

If error message E011 is displayed, a button may have become stuck. Press each button individually and check that they are all clean. If the error message remains, please contact the after-sales service.

### Replacing the oven light bulb

It is possible to replace the oven light. Heat-resistant 12 V, 20 W halogen bulbs can be obtained from After-sales Service or a specialist retailer.

#### Risk of electric shock!

Never replace the oven light when the appliance is switched on. Pull out the mains plug or switch off the appliance at the circuit breaker in the fuse box.

**Note:** Always remove the new halogen bulb from the packaging using a dry cloth. This increases the service life of the bulb.

#### Method

1. Switch off the circuit breaker in the fuse box.
2. Place a tea towel in the cold oven to prevent damage.
3. Remove the glass cover. To do so, prise open the glass cover at the bottom by hand. Should you experience difficulties removing the glass cover, use a spoon to help. (Fig. A)
4. Remove the bulb and replace with a bulb of the same type. (Fig. B)

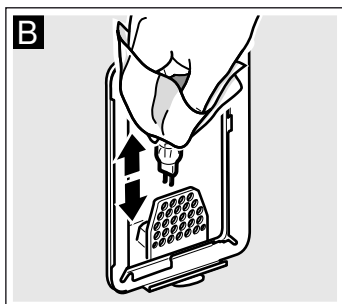
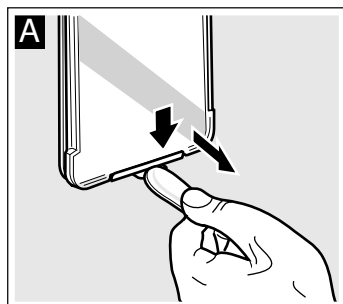

5. Refit the glass cover. (Fig. C)

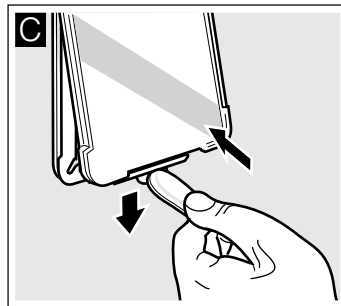

6. Remove the tea towel. Switch the circuit breaker in the fuse box back on or plug in the mains plug.

### Replacing the door seal

If the door seal is defective, it must be replaced. Replacement seals for your appliance can be obtained from the after-sales service. Please supply your appliance's E number and FD number.

#### Risk of serious damage to health!

Never use the appliance if the door seal is damaged. Microwave energy may escape. Do not use the appliance again until it has been repaired.

1. Open the oven door.
2. Remove the old door seal.
3. There are 5 hooks attached to the door seal. Use these hooks to attach the new seal to the oven door.

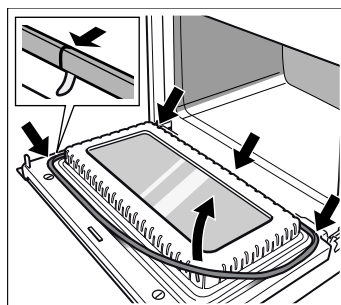

**Note:** The presence of the join at the bottom of the door seal in the centre is technically required.

---

## After-sales service

Our after-sales service is there for you if your appliance needs to be repaired. We will always find the right solution in order to avoid unnecessary visits from a service technician.

### E number and FD number

When calling us, please give the product number (E no.) and the production number (FD no.) so that we can provide you with the correct advice. The rating plate bearing these numbers can be found in the oven. You can make a note of the number of your appliance and the telephone number of the after-sales service in the space below to save time should it be required.

E no.	FD no.
<hr/>	
<b>After-sales service</b> 	
<hr/>	

Please note that there will be a fee for a visit by a service technician in the event of a malfunction, even during the warranty period.

Please find the contact data of all countries in the enclosed customer service list.

### To book an engineer visit and product advice

**GB** 0844 8928979

Calls from a BT landline will be charged at up to 3 pence per minute. A call set-up fee of up to 6 pence may apply.

**IE** 01450 2655

0.03 € per minute at peak. Off peak 0.0088 € per minute.

Rely on the professionalism of the manufacturer. You can therefore be sure that the repair is carried out by trained service technicians who carry original spare parts for your appliances.

This appliance corresponds to the standards EN 55011 and CISPR 11. It is a Group 2, Class B product.

Group 2 means that microwaves are produced for the purpose of heating food. Class B states that the appliance is suitable for private households.

---

## Energy and environment tips

Here you can find tips on how to save energy when baking and roasting and how to dispose of your appliance properly.

### Saving energy

Only preheat the oven if this is specified in the recipe or in the operating instruction tables.

Use dark, black lacquered or enamelled baking tins. They absorb the heat particularly well.

Open the appliance door as little as possible during cooking, baking or roasting.

It is best to bake several cakes one after the other. The cooking compartment is still warm. This may reduce the baking time for the second cake.

For longer cooking times, you can switch the oven off 10 minutes before the end of the cooking time and use the residual heat to finish cooking.

### Environmentally-friendly disposal

Dispose of packaging in an environmentally-friendly manner.



This appliance is labelled in accordance with European Directive 2012/19/EU concerning used electrical and electronic appliances (waste electrical and electronic equipment - WEEE). The guideline determines the framework for the return and recycling of used appliances as applicable throughout the EU.

---

## Automatic programmes

The automatic programmes enable you to prepare food very easily. You select the programme and enter the weight of your food. The automatic programme makes the optimum setting.

### Ovenware

The automatic programmes are only intended for roasting in ovenware with a lid. For all programmes, use deep ovenware with lid. Place the ovenware on the wire rack at level 1.

### Suitable cookware

Heat-resistant (up to 300 °C) glass or glass ceramic ovenware, for example, is suitable.

### Unsuitable cookware

Cookware made of unglazed clay and plastic cookware or cookware with plastic handles is not suitable.

Metal cookware is not suitable.

The microwave is used for some programmes. Metal does not

allow microwaves to pass through. The food will not brown as much and the meat will not be as well cooked.

### Size of the ovenware

The meat should cover about two thirds of the ovenware base. This will ensure that you get good meat juices.

The distance between the meat and the lid must be at least 3 cm. The meat may expand during the roasting process.

## Selecting a programme

Example in diagram: settings for 1 kg of fresh chicken portions.

1. Press the  button.

The first programme group and first programme appear.

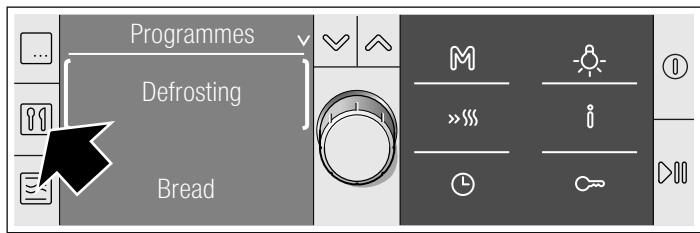

2. Select the programme group by turning the rotary selector.

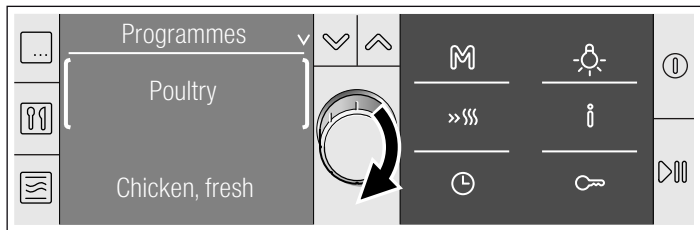

3. Press the  button to change the line.

4. Use the rotary selector to select the programme.

A suggested weight appears for the programme selected.

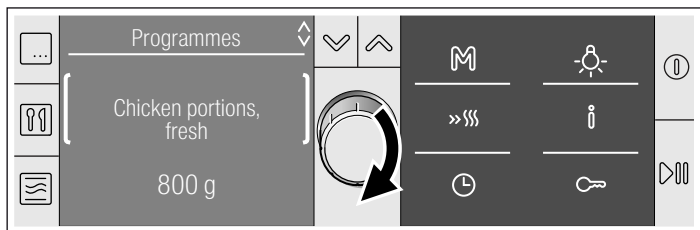

5. Press the  button.

6. Turn the rotary selector to specify the weight of the dish.

If you switch to the lower bar, you can alter the cooking result (see *Adjust cooking result individually*).

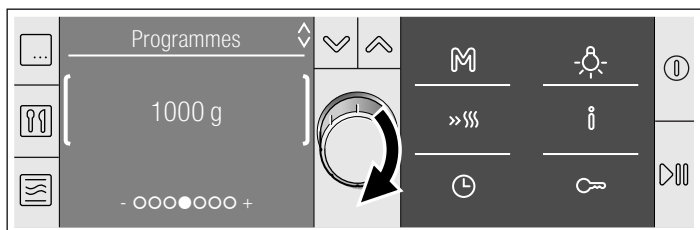

7. Press the  button.

The programme starts. The cooking time appears in the status bar and starts to count down.

### The programme has ended

A signal sounds. The oven stops heating. You can cancel the signal earlier by pressing the  button. The elapsed cooking time in the status bar is 00:00:00.

### labelling the programme

Press and hold the  button until the intervention display appears. You can make new settings.

### Setting a later end time

See the section entitled *Time-setting options - Setting a later end time*.

## Individually adjusting the cooking result:

If the cooking result of a programme does not meet your expectations, you can change it the next time.

Make the settings as described in steps 1 to 6.

Press the  button and move the illuminated field using the rotary selector.

- 000●000 +

To the left = cooking result less well done

To the right = cooking result more well done.

Press the  button to start the programme.

## Defrosting and cooking with the automatic programmes

### Notes

- Take the food out of its packaging and weigh it. If it is not possible to enter the exact weight, you should round it up or down.
- Always use microwaveable ovenware, e.g. made of glass, ceramic or the universal pan. Observe the accessories tips in the programme table.
- Place the food in the cold cooking compartment.
- A table of suitable types of food with appropriate weight ranges and the accessories required can be found in the section after the tips.
- It is not possible to set a weight outside the weight range.
- With many dishes, a signal sounds after a certain time. Turn or stir the food.

### Defrost

#### Notes

- If possible, freeze and store food flat and in portions at -18 °C.
- Put the frozen food on shallow tableware, e.g. a glass or porcelain plate. Place bread rolls directly on the wire rack.
- Cover thin and protruding parts with small pieces of aluminium foil. This prevents these parts from cooking prematurely. Ensure that the aluminium foil does not touch the walls of the cooking compartment.
- After defrosting, allow the food to defrost for a further 10 to 90 minutes so that it acquires an even temperature.
- Liquid will be produced when defrosting meat, poultry or fish. Drain off this liquid when you turn the food. Under no circumstances should it be used for other purposes or be allowed to come into contact with other foods.
- Place beef, lamb and pork on the ovenware fatty-side down first.
- Bread should only be defrosted in the required amounts, as it quickly becomes stale.
- After turning, remove any minced meat that has already defrosted.
- Whole poultry should be placed in the ovenware breast-side down and poultry portions skin-side down. Cover legs and wings with small pieces of aluminium foil.
- For whole fish, cover the tail with aluminium foil, for fish fillets cover the edges and for fish steaks cover the protruding ends.

Programme group Programme	Suitable food	Weight range in kg	Ovenware/accessories, shelf height
<b>Defrost</b>			
Wheat bread		0.10 - 0.60	Shallow ovenware without lid, wire rack, level 1
Wholemeal bread***		0.20 - 1.50	Shallow ovenware without lid, wire rack, level 1
Bread rolls		0.05 - 0.45	Wire rack, level 1
Cakes, dry*	Sponge cake without glaze or icing, plaited yeast cake	0.20 - 1.50	Shallow ovenware without lid, wire rack, level 1
Cake, moist	Sponge cake with fruit without icing, glaze or gelatine, with no crème pâtissière or cream	0.20 - 1.20	Shallow ovenware without lid, wire rack, level 1
Minced meat*	Minced beef, lamb, or pork	0.20 - 1.00	Shallow ovenware without lid, wire rack, level 1
Beef**	Joint of beef, joint of veal, steak	0.20 - 2.00	Shallow ovenware without lid, wire rack, level 1
Pork**	Boned pork neck joint, rolled roasting joint, schnitzel, goulash	0.20 - 2.00	Shallow ovenware without lid, wire rack, level 1
Lamb**	Leg of lamb, lamb shoulder, rolled roasting joint of lamb	0.20 - 2.00	Shallow ovenware without lid, wire rack, level 1
Whole poultry**	Chicken, duck	0.70 - 2.00	Shallow ovenware without lid, wire rack, level 1
Poultry portions**	Chicken thigh, half chicken, leg of goose, goose breast, duck breast	0.20 - 1.20	Shallow ovenware without lid, wire rack, level 1
Whole fish**	Trout, haddock, cod	0.20 - 1.20	Shallow ovenware without lid, wire rack, level 1
Fish fillet**	Fillet of pike, cod, salmon, rosefish, pollock, pike-perch	0.20 - 1.00	Shallow ovenware without lid, wire rack, level 1
Fish steak**	Cod, pike, haddock, salmon steak	0.20 - 1.00	Shallow ovenware without lid, wire rack, level 1

\* Signal to turn after the cooking time is approximately halfway through.

\*\* Signal to turn after  $\frac{1}{3}$  and  $\frac{2}{3}$  of the cooking time has elapsed.

\*\*\*Signal to turn after  $\frac{2}{3}$  of the cooking time has elapsed.

## Cooking

### Vegetables

#### Notes

- Fresh vegetables: cut into pieces of equal size. Add 2 tablespoons of water for every 100 g of vegetables.
- Frozen vegetables: this programme is only suitable for blanched, not pre-cooked vegetables. It is not suitable for fro-

zen vegetables in cream sauce. Add 1 to 2 tablespoons of water per 100 g. Do not add water to spinach or red cabbage.

- After the programme has ended, leave the vegetables to stand for approx. a further 5 minutes.

Programme group Programme	Suitable food	Weight range in kg	Ovenware/accessories, shelf height
<b>Vegetables</b>			
Cook fresh vegetables*	Cauliflower, broccoli, carrots, kohlrabi, leeks, peppers, courgettes	0.20 - 1.00	Ovenware with lid, wire rack, level 1
Cook frozen vegetables*	Cauliflower, broccoli, carrots, kohlrabi, red cabbage, spinach	0.20 - 1.00	Ovenware with lid, wire rack, level 1

\* Signal to stir halfway through the cooking time.

## Potatoes

#### Notes

- Boiled potatoes: cut into pieces of equal size. Add 2 tablespoons of water per 100 g of potatoes, and salt to taste.
- Unpeeled boiled potatoes: use potatoes of the same size. Wash the potatoes and prick the skin several times. Place them in ovenware while still wet. Do not add water.
- After the programme has ended, leave the potatoes to stand for approx. a further 5 minutes. Strain away the remaining water beforehand.
- For potato gratin, layer the potatoes in shallow ovenware 3 to 4 cm deep.
- After the programme has ended, leave the bake to stand in the appliance for an additional 5 to 10 minutes.
- Chips, croquettes and röstis must be suitable for preparation in the oven.



Programme group Programme	Suitable food	Weight range in kg	Ovenware/accessories, shelf height
<b>Potatoes</b>			
Boiled potatoes*	Waxy potatoes, quite waxy potatoes, floury potatoes	0.20 - 1.00	Ovenware with lid, wire rack, level 1
Unpeeled boiled potatoes*	Waxy potatoes, quite waxy potatoes, floury potatoes	0.20 - 1.00	Ovenware with lid, wire rack, level 1
Potato gratin, fresh		0.50 - 3.00	Shallow ovenware without lid, wire rack, level 2
Chips, frozen**		0.20 - 0.60	Universal pan, level 2
Croquettes, frozen**		0.20 - 0.70	Universal pan, level 2
Röstis, frozen**		0.20 - 0.80	Universal pan, level 2

\* Signal to stir halfway through the cooking time.

\*\* Signal to turn after  $\frac{2}{3}$  of the cooking time has elapsed.

## Cereal products

### Notes

- Cereal products foam a lot during cooking. Therefore, use a deep dish with a lid for all cereal products. Enter the weight of the uncooked cereal product (without liquid).
- Rice:  
Do not use boil-in-the-bag rice. Add two to two and a half times the amount of liquid to the rice.

- Polenta:  
For polenta, add two to three times the amount of water depending on the degree of grinding.
- Couscous:  
Add two times the amount of liquid.
- Millet:  
Add two to two and a half times the amount of liquid.
- After the programme has ended, leave the cereal to stand for approx. a further 5 to 10 minutes.

Programme group Programme	Weight range in kg	Ovenware/accessories, shelf height
<b>Cereal products</b>		
Long grain rice*	0.10 - 0.50	Deep ovenware with lid, wire rack, level 1
Basmati rice*	0.10 - 0.50	Deep ovenware with lid, wire rack, level 1
Brown rice*	0.10 - 0.50	Deep ovenware with lid, wire rack, level 1
Polenta***	0.10 - 0.50	Deep ovenware with lid, wire rack, level 1
Couscous**	0.10 - 0.50	Deep ovenware with lid, wire rack, level 1
Millet*	0.10 - 0.50	Deep ovenware with lid, wire rack, level 1

\* Signal to stir after approx. 2 - 14 minutes depending on weight.

\*\* Signal to stir after 1-2 minutes.

\*\*\* Signal to stir halfway through the cooking time.

## Bake

### Notes

- Place the meal in microwaveable ovenware on the wire rack.
- Layer sweet and savoury bakes in shallow ovenware approx. 5 cm deep.

- For potato gratin, layer the potatoes in shallow ovenware 3 to 4 cm deep.
- After the programme has ended, leave the potato gratin to stand in the appliance for an additional 5 to 10 minutes.

Programme group Programme	Weight range in kg	Ovenware/accessories, shelf height
<b>Bake</b>		
Lasagne bolognese, frozen	0.40 - 1.00	Ovenware without lid, wire rack, level 1
Cannelloni, frozen	0.40 - 1.00	Ovenware without lid, wire rack, level 1
Macaroni bake, frozen	0.40 - 1.00	Ovenware without lid, wire rack, level 1
Bake, savoury, cooked ingredients	0.40 - 3.00	Shallow ovenware without lid, wire rack, level 2
Bake, sweet	0.50 - 1.80	Shallow ovenware without lid, wire rack, level 1
Potato gratin, fresh	0.50 - 3.00	Shallow ovenware without lid, wire rack, level 2

## Frozen products

### Notes

- Use prebaked, frozen pizza and pizza baguettes.
- Chips, croquettes and röstis must be suitable for preparation in the oven.

- Spring rolls and mini spring rolls must be suitable for preparation in the oven.
- Make sure that frozen food is placed in a single layer.

Programme group Programme	Weight range in kg	Ovenware/accessories, shelf height
Pizza, thin base	0.30 - 0.50	Universal pan, level 1
Pizza, deep-pan	0.40 - 0.60	Universal pan, level 1
Mini pizza	0.10 - 0.60	Universal pan, level 1
Pizza baguettes, prebaked	0.10 - 0.75	Universal pan, level 1
Chips*	0.20 - 0.60	Universal pan, level 2
Croquettes*	0.20 - 0.70	Universal pan, level 2
Röstis*	0.20 - 0.80	Universal pan, level 2
Lasagne bolognese	0.40 - 1.00	Ovenware without lid wire rack, level 1
Cannelloni	0.40 - 1.00	Ovenware without lid wire rack, level 1
Macaroni bake	0.40 - 1.00	Ovenware without lid wire rack, level 1
Spring rolls**	0.10 - 1.00	Universal pan, level 2
Mini spring rolls**	0.10 - 0.60	Universal pan, level 2
Fish fingers*	0.20 - 0.90	Universal pan, level 2
Breaded squid rings*	0.20 - 0.50	Universal pan, level 2

\* Signal to turn after  $\frac{2}{3}$  of the cooking time has elapsed.

\*\* Signal to turn after the cooking time is halfway through.

## Poultry

### Notes

- Place chicken or poulard in the ovenware breast-side down.
- Place chicken portions in the ovenware skin-side up.

- Cook turkey breast without the skin. Add 100 to 150 ml of liquid to the turkey breast. Add another 50 to 100 ml of liquid after turning if necessary.
- After the programme has ended, leave the turkey breast to stand for a further 10 minutes.

Programme group Programme	Suitable food	Weight range in kg	Ovenware/accessories, shelf height
<b>Poultry</b>			
Chicken, fresh*	Whole chicken	0.80 - 1.80	Deep ovenware with lid, wire rack, level 1
Chicken portions, fresh	Chicken thigh, half chicken	0.40 - 1.20	Deep ovenware with lid, wire rack, level 1
Poulard, fresh*		1.50 - 3.00	Deep ovenware with lid, wire rack, level 1
Turkey breast, fresh**	Skinless turkey breast	0.80 - 2.00	Deep ovenware with lid, wire rack, level 1

\* Signal to turn whole chicken after  $\frac{2}{3}$  of the cooking time has elapsed.

\*\* Signal to turn after the cooking time is halfway through.

## Meat

### Notes

- Cook sirloin fatty-side down first.
- Joint of beef, joint of veal, knuckle of veal, leg of lamb and joint of pork:  
The joint should cover two thirds of the ovenware base. Add

- 50 to 100 ml of liquid to the roast. Add another 50 to 100 ml of liquid after turning if necessary.
- Add 50 to 100 ml of liquid to the meat loaf.
- After the programme has ended, leave the roast to stand for another 10 minutes.

Programme group Programme	Suitable food	Weight range in kg	Ovenware/accessories, shelf height
<b>Beef</b>			
Pot roast, fresh**		0.80 - 2.00	Deep ovenware with lid, wire rack, level 1
Sirloin, medium*	Thick piece of sirloin, 5 - 6 cm	0.80 - 2.00	Ovenware without lid, wire rack, level 1
Sirloin, rare*	Thick piece of sirloin, 5 - 6 cm	0.80 - 2.00	Ovenware without lid, wire rack, level 1
Meat loaf	approx. 8 cm deep	0.80 - 1.50	Ovenware with lid, wire rack, level 1
Roulades		0.50 - 3.00	Deep ovenware with lid, wire rack, level 1

### Veal

\* Signal to turn after the cooking time is halfway through

\*\* Signal to turn after  $\frac{1}{3}$  and  $\frac{2}{3}$  of the cooking time has elapsed.

\*\*\* Signal to turn after  $\frac{2}{3}$  of the cooking time has elapsed.

Programme group Programme	Suitable food	Weight range in kg	Ovenware/accessories, shelf height
Joint, fresh*	Rump, flank	0.80 - 2.00	Ovenware with lid, wire rack, level 1
Knuckle on the bone, fresh		0.80 - 3.00	Ovenware with lid, wire rack, level 1
Osso buco		0.80 - 3.00	Ovenware with lid, wire rack, level 1
<b>Pork</b>			
Pork neck joint, fresh, boned***		0.80 - 2.00	Ovenware with lid, wire rack, level 1
Neck joint, fresh, on the bone*		0.80 - 2.50	Ovenware with lid, wire rack, level 1
Joint with crust, fresh		0.80 - 2.00	Ovenware with lid, wire rack, level 1
Meat loaf	approx. 8 cm deep	0.80 - 1.50	Ovenware with lid, wire rack, level 1
Rolled roasting joint, fresh*		1.00 - 3.00	Ovenware with lid, wire rack, level 1
<b>Lamb</b>			
Leg, fresh, boned, medium*		0.80 - 2.00	Ovenware with lid, wire rack, level 1
Leg, fresh, on the bone, well-done*		0.80 - 2.00	Ovenware with lid, wire rack, level 1
Meat loaf	approx. 8 cm deep	0.80 - 1.50	Ovenware with lid, wire rack, level 1
<b>Game</b>			
Joint of venison, fresh*		0.50 - 3.00	Deep ovenware with lid, wire rack, level 1
Leg of roe venison, boned, fresh***		0.50 - 2.50	Deep ovenware with lid, wire rack, level 1
Haunch of hare, on the bone, fresh***		0.50 - 1.50	Deep ovenware with lid, wire rack, level 1
Wild boar joint, fresh***		0.50 - 2.50	Deep ovenware with lid, wire rack, level 1
Rabbit, fresh		0.50 - 2.00	Deep ovenware with lid, wire rack, level 1

\* Signal to turn after the cooking time is halfway through

\*\* Signal to turn after  $\frac{1}{3}$  and  $\frac{2}{3}$  of the cooking time has elapsed.

\*\*\*Signal to turn after  $\frac{2}{3}$  of the cooking time has elapsed.

## Fish

### Notes

- Whole fish, fresh:

Add 1 to 3 tablespoons of water or lemon juice.

Fish fillet, fresh

Add 1 to 3 tablespoons of water or lemon juice.

- Breaded squid rings, frozen:

They must be suitable for cooking in the oven.

Programme group Programme	Weight range in kg	Ovenware/accessories, shelf height
Braise whole fresh fish	0.30 - 1.10	Ovenware with lid, wire rack, level 1
Steam fresh fish fillet	0.20 - 1.00	Ovenware with lid, wire rack, level 1
Fish fingers*	0.20 - 0.90	Universal pan, level 2
Squid rings, frozen*	0.20 - 0.50	Universal pan, level 2

\* Signal to turn after  $\frac{2}{3}$  of the cooking time has elapsed.

## Meat loaf and stew

**Note:** Add 50 to 100 ml of liquid to the meat loaf.

Programme group Programme	Suitable food	Weight range in kg	Ovenware/accessories, shelf height
<b>Meat loaf</b>			
Made from fresh beef	approx. 8 cm deep	0.80 - 1.50	Ovenware with lid, wire rack, level 1
Made from fresh pork	approx. 8 cm deep	0.80 - 1.50	Ovenware with lid, wire rack, level 1
Made from fresh, mixed meat	approx. 8 cm deep	0.80 - 1.50	Ovenware with lid, wire rack, level 1
Made from fresh lamb	approx. 8 cm deep	0.80 - 1.50	Ovenware with lid, wire rack, level 1
<b>Stew*</b>			
Goulash		0.30 - 2.00	Deep ovenware with lid, wire rack, level 1
Roulades		0.50 - 3.00	Deep ovenware with lid, wire rack, level 1

\* Set the weight of the meat

# Tested for you in our cooking studio

You will find a selection of dishes and the ideal settings for them. We will show you which type of heating and which temperature or microwave power setting is best for your meal. You can find information about suitable accessories and the height at which they should be inserted. There are also tips about cookware and preparation methods.

## Notes

- The values in the table always apply to food placed in the cooking compartment when it is cold and empty. Only preheat the appliance if the table specifies that you should do so. Before using the appliance, remove all accessories from the cooking compartment that you will not be using.
- Do not line the accessories with greaseproof paper until after they have been preheated.
- The times specified in the tables are only guidelines. They will depend on the quality and composition of the food.
- Use the accessories provided. Additional accessories may be obtained as optional accessories from specialist retailers or from the after-sales service.
- Always use an oven cloth or oven gloves when taking hot accessories or cookware out of the cooking compartment.
- When using the microwave solo, i.e. on its own without any type of heating, always use the wire rack at level 1.

## Defrosting, heating up and cooking with the microwave

The following tables provide you with numerous options and settings for the microwave.

Defrost	Weight	Microwave power setting in watts, cooking time in minutes	Notes
Whole pieces of beef, veal or pork (on the bone or boned)	800 g	180 W, 15 mins + 90 W, 10-15 mins	Turn several times
	1 kg	180 W, 15 mins + 90 W, 20-30 mins	
	1.5 kg	180 W, 25 mins + 90 W, 25-35 mins	
Meat in pieces or slices of beef, veal or pork	200 g	180 W, 5 mins + 90 W, 4-6 mins	Separate any defrosted parts when turning
	500 g	180 W, 8 mins + 90 W, 5-10 mins	
	800 g	180 W, 10 mins + 90 W, 10-15 mins	
Minced meat, mixed	200 g	90 W, 8-15 mins	Turn several times, remove any defrosted meat
	500 g	180 W, 5 mins + 90 W, 10-15 mins	
	800 g	180 W, 10 mins + 90 W, 15-20 mins	
	1 kg	180 W, 10 mins + 90 W, 20-25 mins	
Poultry or poultry portions	600 g	180 W, 5 mins + 90 W, 13-18 mins	Turn during cooking.
	1.2 kg	180 W, 10 mins + 90 W, 10-15 mins	
Duck	2 kg	180 W, 10 mins + 90 W, 30-40 mins	Turn several times
Goose	4.5 kg	180 W, 20 mins + 90 W, 60-80 mins	Turn every 20 minutes, remove liquid that escapes during defrosting
Fish fillet, fish steak or slices	400 g	180 W, 5 mins + 90 W, 10-15 mins	Separate any defrosted parts.
Whole fish	300 g	180 W, 3 mins + 90 W, 10-15 mins	Turn during cooking.
	600 g	180 W, 8 mins + 90 W, 10-15 mins	
Vegetables, e.g. peas	300 g	180 W, 5-15 mins	Stir carefully during defrosting.
	600 g	180 W, 10 mins + 90 W, 8-13 mins	
Fruit, e.g. raspberries	300 g	180 W, 5-10 mins	Stir carefully during defrosting and separate any defrosted parts.
	500 g	180 W, 8 mins + 90 W, 5-10 mins	
Butter, defrosting	125 g	90 W, 7-9 mins	Remove all packaging.
	250 g	180 W, 2 mins + 90 W, 3-5 mins	
Loaf of bread	500 g	180 W, 3 mins + 90 W, 10-15 mins	Turn during cooking.
	1 kg	180 W, 3 mins + 90 W, 15-25 mins	

The times specified in the tables are only guidelines. They may vary according to the ovenware used, the quality, temperature and consistency of the food.

Time ranges are often specified in the tables. Set the shortest time first and then extend the time if necessary.

It may be that you have different quantities from those specified in the tables. A rule of thumb can be applied:

Double the amount - almost twice the cooking time,  
Half the amount - half the cooking time.

Insert the wire rack at level 1. Place the ovenware in the centre. The food will then absorb the microwaves from all sides.

## Defrosting

### Notes

- Place the frozen food in an open container on the wire rack.
- Delicate parts such as the legs and wings of chicken or fatty outer layers of roasts can be covered with small pieces of aluminium foil. The foil must not touch the cooking compartment walls. You can remove the foil half way through the defrosting time.
- Turn or stir the food once or twice during the defrosting time. Large pieces of food should be turned several times. When turning, remove any liquid that has resulted from defrosting.
- Leave defrosted items to stand at room temperature for a further 10 to 60 minutes so that the temperature can stabilise. The giblets can be removed from poultry at this point.

Defrost	Weight	Microwave power setting in watts, cooking time in minutes	Notes
Cakes, dry, e.g. sponge cake	500 g	90 W, 10-15 mins	Only for cakes without icing, cream or crème pâtissière, separate the pieces of cake.
	750 g	180 W, 2 mins + 90 W, 10-15 mins	
Cakes, moist, e.g. fruit flan, cheesecake	500 g	180 W, 5 mins + 90 W, 15-20 mins	Only for cakes without icing, cream or crème pâtissière
	750 g	180 W, 10 mins + 90 W, 15-20 mins	

### Defrosting, heating up or cooking frozen food

#### Notes

- Take ready meals out of the packaging. They will heat up more quickly and evenly in microwaveable ovenware. The different components of the meal may not require the same amount of time to heat up .
- Food which lies flat will cook more quickly than food which is piled high. You should therefore distribute the food so that it is as flat as possible in the ovenware. Different foodstuffs should not be placed in layers on top of one another.

- Always cover the food. If you do not have a suitable cover for your ovenware, use a plate or special microwave foil.
- Stir or turn the food 2 or 3 times during cooking.
- After heating, allow the food to stand for a further 2 to 5 minutes so that it can achieve an even temperature.
- Always use an oven cloth or oven gloves when removing plates from the oven.
- This will help the food retain its own distinct taste, so it will require less seasoning.

Defrosting, heating up or cooking frozen food	Weight	Microwave power setting in watts, cooking time in minutes	Notes
Menu, plated meal, ready meal	300-400 g	600 W, 11-15 mins	Take meal out of packaging; cover food before heating
Soup	400-500 g	600 W, 8-13 mins	Ovenware with lid
Stew	500 g	600 W, 10-15 mins	Ovenware with lid
	1 kg	600 W, 20-25 mins	
Slices or pieces of meat in sauce, e.g. goulash	500 g	600 W, 12-17 mins	Ovenware with lid
	1 kg	600 W, 25-30 mins	
Fish, e.g. fillets	400 g	600 W, 10-15 mins	Covered
	800 g	600 W, 18-23 mins	
Side dishes, e.g. rice, pasta	250 g	600 W, 2-5 mins	Ovenware with lid; add liquid
	500 g	600 W, 7-10 mins	
Vegetables, e.g. peas, broccoli, carrots	300 g	600 W, 8-12 mins	Ovenware with lid; add 1 tbsp of water
	600 g	600 W, 13-18 mins	
Creamed spinach	450 g	600 W, 11-16 mins	Cook without additional water

### Heating food

#### ⚠ Risk of scalding!

There is a possibility of delayed boiling when a liquid is heated. This means that the liquid reaches boiling temperature without the usual steam bubbles rising to the surface. Even if the container only moves a little, the hot liquid can suddenly boil over and spatter. When heating liquids, always place a spoon in the container. This will prevent delayed boiling.

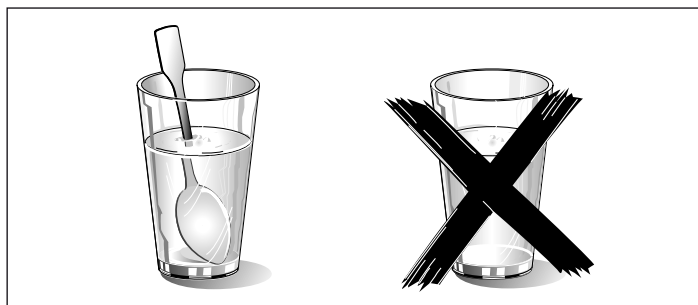

#### Caution!

Metal - e.g. a spoon in a glass - must be kept at least 2 cm from the oven walls and the inside of the door. Sparks could irreparably damage the glass on the inside of the door.

#### Notes

- Take ready meals out of the packaging. They will heat up more quickly and evenly in microwaveable ovenware. The different components of the meal may not require the same amount of time to heat up .
- Always cover the food. If you do not have a suitable cover for your container, use a plate or special microwave foil.
- Stir or turn the food several times during the heating time. Check the temperature.
- After heating, allow the food to stand for a further 2 to 5 minutes so that it can achieve an even temperature.
- Always use an oven cloth or oven gloves when removing plates from the oven.

Heating food	Weight	Microwave power setting in watts, cooking time in minutes	Notes
Menu, plated meal, ready meal	350-500 g	600 W, 4-8 mins	Take meal out of packaging, cover food before heating

Heating food	Weight	Microwave power setting in watts, cooking time in minutes	Notes
Drinks	150 ml	900 W, 1-3 mins	<b>Caution!</b> Place a spoon in the glass. Do not overheat alcoholic drinks. Check during heating
	300 ml	900 W, 3-4 mins	
	500 ml	900 W, 4-5 mins	
Baby food, e.g. baby bottle	50 ml	360 W, ½-1 min	Place baby bottles on the cooking compartment floor without the teat or lid. Shake or stir well after heating. You must check the temperature
	100 ml	360 W, 1-1½ mins	
	200 ml	360 W, 1-2 mins	
Soup 1 cup 2 cups 4 cups	175 g	900 W, 1½-2 mins	-
	175 g each	900 W, 2-4 mins	
	175 g each	900 W, 4-6 mins	
Slices or pieces of meat in sauce, e.g. goulash	500 g	600 W, 7-10 mins	Covered
Stew	400 g	600 W, 5-7 mins	Ovenware with lid
	800 g	600 W, 7-10 mins	
Vegetables	150 g	600 W, 2-3 mins	Add a little liquid
	300 g	600 W, 3-5 mins	

### Cooking food

#### Notes

- Food which lies flat will cook more quickly than food which is piled high. You should therefore distribute the food so that it is as flat as possible in the ovenware. Different foodstuffs should not be placed in layers on top of one another.
- Cook the food in ovenware with a lid. If you do not have a suitable lid for your ovenware, use a plate or special microwave foil.

- This will help the food retain its own distinct taste, so it will require less seasoning.
- After cooking, allow the food to stand for a further 2 to 5 minutes so that it can achieve an even temperature.
- Always use an oven cloth or oven gloves when removing plates from the oven.

Cooking food	Weight	Microwave power in watts, Cooking time in minutes	Notes
Whole chicken, fresh, no giblets	1.5 kg	600 W, 25-30 mins	Turn halfway through the cooking time
Fish fillet, fresh	400 g	600 W, 8-13 mins	-
Fresh vegetables	250 g	600 W, 6-10 mins	Cut into equal-sized pieces; add 1 to 2 tbsp water per 100 g; stir during cooking
	500 g	600 W, 10-15 mins	
Potatoes	250 g	600 W, 8-11 mins	Cut into equal-sized pieces; add 1 to 2 tbsp water per 100 g; stir during cooking
	500 g	600 W, 12-15 mins	
	750 g	600 W, 15-22 mins	
Rice	125 g	600 W, 4-6 mins+ 180 W, 12-15 mins	Add double the quantity of liquid and use deep ovenware with a lid
	250 g	600 W, 7-9 mins+ 180 W, 15-20 mins	
Sweet foods, e.g. blancmange (instant)	500 ml	600 W, 5-8 mins	Stir 2 to 3 times with an egg whisk while heating
Fruit, compote	500 g	600 W, 9-12 mins	-

### Popcorn for the microwave

#### Notes

- Use heat-resistant, flat glass ovenware, e.g. the lid of an ovenproof dish, a glass plate or a glass tray (Pyrex)
- Always place the ovenware on the wire rack at level 1.
- Do not use porcelain or extremely curved plates.
- Make the settings as described in the table. You can adjust the timings according to product and amount.

- So that the popcorn doesn't burn, briefly take the popcorn bag out of the oven after 1 minute and 30 seconds and shake it. Take care as the bag will be hot!

#### Risk of scalding!

- Open the popcorn bag carefully as hot steam may be released.
- Never set the microwave to full power.

	Weight	Accessories	Level	Microwave power in watts, Cooking time in minutes
Popcorn for the microwave	1 bag, 100 g	Ovenware, wire rack	1	600 W, 4 mins

## Microwave tips

You cannot find any information about the settings for the quantity of food you have prepared.	Increase or reduce the cooking times using the following rule of thumb: Double the amount = almost double the cooking time Half the amount = half the cooking time
The food has become too dry.	Next time, set a shorter cooking time or select a lower microwave power setting. Cover the food and add more liquid.
When the time has elapsed, the food is not defrosted, hot or cooked.	Set a longer time. Large quantities and food which is piled high require longer times.
When the time has elapsed, the food is overheated at the edge but not done in the middle.	Stir it during the cooking time and next time, select a lower microwave power setting and a longer cooking time.
After defrosting, the poultry or meat is defrosted on the outside but not defrosted in the middle.	Next time, select a lower microwave power setting. If you are defrosting a large quantity, turn it several times.

## Cakes and pastries

### About the tables

#### Notes



- The times given apply to food placed in a cold oven.
- The temperature and baking time depend on the consistency and amount of the mixture. This is why temperature ranges are given in the tables. Begin with the lower temperature and, if necessary, use a higher setting the next time, since a lower temperature results in more even browning.













- Additional information can be found in the *Baking tips* section following the tables.

- Always place the cake tin in the centre of the wire rack.

#### Baking tins



**Note:** It is best to use dark-coloured metal baking tins.



-  Hot air
-  Top/bottom heating
-  Intensive heat



Cakes in tins	Accessories	Level	Type of heating	Temperature °C	Microwave power in watts	Cooking time in minutes
Sponge cake, simple	Ring tin/round tin	1		160-180	90 W	30-40
Sponge cake, delicate (e.g. pound cake)	Ring tin/round tin	1		150-170	-	60-80
Sponge flan base	Flan tin	2		160-180	-	25-35
Delicate fruit flan, sponge	Springform/ring tin	1		160-180	90 W	30-40
Sponge base, 2 eggs	Flan tin	1		150-160	-	20-25
Sponge flan, 6 eggs**	Dark springform cake tin	1		170-180	-	30-40
Shortcrust pastry base with crust	Dark springform cake tin	1		170-190	-	30-40
Fruit tart/cheesecake with pastry base*	Dark springform cake tin	2		160-170	180 W	30-40
Swiss flan	Dark springform cake tin	1		190-200	-	40-50
Ring cake	Ring cake tin	1		160-180	90 W	30-40
Nut cake	Dark springform cake tin	1		170-180	90 W	35-45
Pizza, thin base, light topping**	Round pizza tray	1		220-240	-	15-20
Savoury cakes	Dark springform cake tin	1		180-200	-	50-60

\* Allow cake to cool in the oven for approx. 20 minutes.

\*\* Preheat the cooking compartment

-  Top/bottom heating
-  3D hot air

-  Hot air
-  Intensive heat

Cakes on trays	Accessories	Level	Type of heating	Temperature °C	Microwave power in watts	Cooking time in minutes
Sponge with dry topping	Universal pan	2		160-180	-	25-35
Sponge with dry topping	Universal pan + Enamel baking tray*	1 3		150-170	-	40-50
Sponge with moist topping (fruit)	Universal pan	1		160-180	90 W	30-40

\* Enamel baking trays can be obtained as an optional accessory from specialist retailers.

Cakes on trays	Accessories	Level	Type of heating	Temperature °C	Microwave power in watts	Cooking time in minutes
Yeast dough with dry topping	Universal pan	2		170-190	-	35-45
Yeast dough with dry topping	Universal pan + Enamel baking tray	1 3		160-180	-	50-60
Yeast dough with moist topping (fruit)	Universal pan	2		170-190	-	45-55
Yeast dough with moist topping (fruit)	Universal pan + Enamel baking tray*	1 3		160-180	-	50-60
Shortcrust pastry with dry topping	Universal pan	2		160-180	-	25-35
Shortcrust pastry with dry topping	Universal pan + Enamel baking tray*	1 3		160-180	-	30-40
Shortcrust pastry with moist topping (fruit)	Universal pan	1		160-180	-	50-60
Swiss flan	Universal pan	1		190-200	-	40-50
Swiss roll (preheat)	Universal pan	2		170-190	-	10-20
Plaited loaf with 500 g flour	Universal pan	2		160-180	-	40-50
Stollen with 500 g flour	Universal pan	2		150-170	-	60-70
Stollen with 1 kg flour	Universal pan	2		140-150	-	65-75
Strudel, sweet	Universal pan	1		190-210	180 W	30-40
Pizza	Universal pan	1		210-230	-	25-35
Pizza	Universal pan + Enamel baking tray*	1 3		180-200	-	40-50
Tarte flambée, preheat	Universal pan	2		220-240	-	15-20

\* Enamel baking trays can be obtained as an optional accessory from specialist retailers.

■ Top/bottom heating

■ 3D hot air

Small baked items	Accessories	Level	Type of heating	Temperature in °C	Cooking time in minutes
Biscuits	Universal pan	2		150-170	20-30
Biscuits	Universal pan + Enamel baking tray*	1 3		140-160	30-40
Macaroons	Universal pan	2		120-140	35-45
Macaroons	Universal pan + Enamel baking tray*	1 3		110-130	40-50
Meringue	Universal pan	2		80-100	90-110
Muffins	Muffin tray on wire rack	2		160-180	35-45
Muffins	1 muffin tray each on universal pan & Wire rack	1 3		140-160	50-60
Choux pastry	Universal pan	2		200-220	30-40
Puff pastry	Universal pan	2		170-190	25-35
Puff pastry	Universal pan + Enamel baking tray*	1 3		170-190	30-40
Leavened cake	Universal pan	2		200-220	20-30

\* Enamel baking trays can be obtained as optional accessories from specialist retailers.

■ Top/bottom heating

Always preheat the oven.

■ Hot air

Bread and rolls	Accessories	Level	Type of heating	Temperature °C	Cooking time in minutes
Yeast bread with 1 kg of flour	Universal pan	2		270 + 170	10 15-25
Sourdough bread with 1.2 kg flour	Universal pan	2		270 + 170	10 40-50
Flatbread	Universal pan	2		220-240	15-20
Bread rolls	Universal pan	2		200-220	20-30



Bread and rolls	Accessories	Level	Type of heating	Temperature °C	Cooking time in minutes
Rolls made with sweet yeast dough	Universal pan	2		190-210	15-25

## Baking tips

You want to bake according to your own recipe.	Use similar items in the baking tables as a guide.
Use baking tins made of silicone, glass, plastic or ceramic materials.	The baking tin must be heat-resistant up to 250 °C. Cakes in these baking tins will be less brown. When using the microwave, the cooking time will be shorter than the time shown in the table.
How to establish whether sponge cake is baked through.	Approximately 10 minutes before the end of the baking time specified in the recipe, poke the cake with a cocktail stick at its highest point. If the cocktail stick comes out clean, the cake is ready.
The cake collapses.	Use less liquid next time or set the oven temperature 10 degrees lower and extend the baking time. Observe the specified mixing times in the recipe.
The cake has risen in the middle but is lower around the edge.	Only grease the base of the springform cake tin. After baking, loosen the cake carefully with a knife.
The cake is too dark.	Select a lower temperature and bake the cake for a little longer.
The cake is too dry.	When it is done, make small holes in the cake using a toothpick. Then drizzle fruit juice or an alcoholic beverage over it. Next time, select a temperature 10 degrees higher and reduce the baking time.
The bread or cake (e.g. cheesecake) looks good, but is soggy on the inside (sticky, streaked with water).	Use slightly less fluid next time and bake for slightly longer at a lower temperature. When baking cakes with a moist topping, bake the base first, cover with almonds or bread crumbs and then add the topping. Please follow the recipe and follow the baking times.
The cake cannot be turned out of the dish when it is turned upside down.	After baking, allow the cake to cool for a further 5 to 10 minutes, then it will be easier to turn out of the tin. If it still sticks, carefully loosen the cake around the edges using a knife. Turn the cake tin upside down again and cover it several times with a cold, wet cloth. Next time, grease the tin well and sprinkle some bread crumbs into it.
You have measured the temperature of the oven using your own meat thermometer and found there is a discrepancy.	The oven temperature is measured by the manufacturer after a specified period of time using a test rack in the centre of the cooking compartment. Ovenware and accessories affect the temperature measurement, so there will always be some discrepancy when you measure the temperature yourself.
Sparks are generated between the tin and the wire rack.	Check that the tin is clean on the outside. Change the position of the tin in the cooking compartment. If this does not help, continue baking but without the microwave. The baking time will then be longer.

## Roasting and grilling

### About the tables

The temperature and roasting time depend on the type and amount of food being cooked. This is why temperature ranges are given in the tables. Begin with the lower temperature and, if necessary, use a higher setting the next time,

For more information, see the section entitled *Tips for grilling and roasting* which follows the tables.

### Ovenware

You may use any heat-resistant ovenware which is suitable for use in a microwave. Metal roasting dishes are not suitable for roasting with microwaves.

The ovenware can become very hot. Use oven gloves to take the ovenware out of the oven.

Place hot glass ovenware on a dry kitchen towel after they have been removed from the oven. The glass could crack if placed on a cold or wet surface.

### Tips for roasting

Use a deep roasting dish for roasting meat and poultry.

Check that your ovenware fits in the cooking compartment. It should not be too big.

Meat:

Cover approx. two thirds of the ovenware base with liquid. Add a little more liquid for pot roasts. Turn pieces of meat halfway through the cooking time. When the roast is ready, turn off the oven and allow it to rest for an additional 10 minutes. This allows better distribution of the meat juices.

Poultry:

Turn the pieces of meat after  $\frac{2}{3}$  of the cooking time has elapsed.

### Tips for grilling

#### Notes

- Always keep the oven door closed when grilling and do not preheat.
- As far as possible, the pieces of food you are grilling should be of equal thickness. Steaks should be at least 2 to 3 cm thick. This will allow them to brown evenly and remain succulent and juicy. Do not add salt to steaks until they have been grilled.
- Use tongs to turn the pieces of food you are grilling. If you pierce the meat with a fork, the juices will run out and it will become dry.
- Dark meat, e.g. beef, browns more quickly than lighter-coloured meat such as veal or pork. When grilling light-coloured meat or fish, these often only brown slightly on the surface, although they are cooked and juicy on the inside.
- The grill element switches off and on again automatically. This is normal. The grill setting determines how frequently this will happen.

### Tips for braising



Use ovenware with a lid for braising fish.







Add two to three tablespoons of liquid and a little lemon juice or vinegar into the ovenware.

## Beef

### Notes



- Turn pot-roasted beef after  $\frac{1}{3}$  and  $\frac{2}{3}$  of the cooking time. Finally, allow to stand for approx. a further 10 minutes.





- Turn fillet of beef and sirloin halfway through the cooking time. Finally, allow to stand for approx. a further 10 minutes.
- Turn steaks after  $\frac{2}{3}$  of the cooking time.
-  Top/bottom heating
-  Grill, large area

Beef	Accessories	Level	Type of heating	Temperature in °C, grill setting	Microwave power in watts	Cooking time in minutes
Pot-roasted beef, approx. 1 kg	Ovenware with lid, wire rack	1		190-210	-	120-140
Pot-roasted beef, approx. 1.5 kg	Ovenware with lid, wire rack	1		180-200	-	140-160
Pot-roasted beef, approx. 2 kg	Ovenware with lid, wire rack	1		170-190	-	160-180
Fillet of beef, medium, approx. 1 kg	Ovenware with lid, wire rack	1		180-200	90 W	30-40
Fillet of beef, medium, approx. 1.5 kg	Ovenware with lid, wire rack	1		200-220	90 W	45-55
Sirloin, medium, approx. 1 kg	Ovenware without lid, wire rack	1		240-260	180 W	30-40
Steaks, medium, 3 cm thick	Universal pan + Wire rack	1 3		3	-	1st side: approx. 10-15 2nd side: approx. 5-10

## Veal

**Note:** Turn joints and knuckle of veal halfway through the cooking time. Finally, allow to stand for approx. a further 10 minutes.

-  Hot air
-  Hot air grilling



Veal	Accessories	Level	Type of heating	Temperature in °C, grill setting	Microwave power in watts	Cooking time in minutes
Joint of veal, approx. 1 kg	Ovenware with lid, wire rack	1		210-220	90 W	60-70
Joint of veal, approx. 1.5 kg	Ovenware with lid, wire rack	1		200-210	90 W	70-80
Joint of veal, approx. 2 kg	Ovenware with lid, wire rack	1		190-200	90 W	80-100
Knuckle of veal, approx. 1.5 kg	Ovenware with lid, wire rack	1		190-200	-	120-130





## Pork

### Notes

- Turn lean joints of pork and rindless joints halfway through the cooking time. Finally, allow to stand for approx. a further 10 minutes.
- Place the joint in the ovenware rind-side up. Cut into the rind. Do not turn the joint. Finally, allow to stand for approx. a further 10 minutes.
- Do not turn fillet of pork or smoke-cured pork chops. Finally, allow to stand for approx. a further 5 minutes.

Turn the neck of pork after  $\frac{2}{3}$  of the cooking time.

-  Hot air grilling
-  Grill, large area

Pork	Accessories	Level	Type of heating	Temperature in °C, grill setting	Microwave power in watts	Cooking time in minutes
Joint without rind (e.g. neck), approx. 750 g	Ovenware with lid, wire rack	1		220-240	180 W	40-50
Joint with rind (e.g. shoulder) approx. 1.5 kg	Ovenware without lid, wire rack	1		180-200	-	150
Joint with rind (e.g. shoulder), approx. 2 kg	Ovenware without lid, wire rack	1		170-190	-	180
Pork fillet, approx. 500 g	Ovenware with lid, wire rack	1		210-230	90 W	20-25

Pork	Accessories	Level	Type of heating	Temperature in °C, grill setting	Microwave power in watts	Cooking time in minutes
Joint of pork, lean, approx. 1 kg	Ovenware with lid, wire rack	1		210-230	90 W	50-60
Joint of pork, lean, approx. 1.5 kg	Ovenware with lid, wire rack	1		200-220	90 W	70-80
Joint of pork, lean, approx. 2 kg	Ovenware with lid, wire rack	1		190-210	180 W, 10 min. + 90 W, 75-85 min.	85-95
Smoked pork on the bone, approx. 1 kg	Ovenware without lid, wire rack	1	-	-	360 W	45-50
Neck of pork 2 cm thick	Universal pan + Wire rack	1 3		2	-	1st side: approx. 15-20 2nd side: approx. 10-15

### Lamb and game

**Note:** Turn lamb and game halfway through the cooking time.

- Hot air grilling
- Top/bottom heating

Lamb and game	Accessories	Level	Type of heating	Temperature °C	Microwave power in watts	Cooking time in minutes
Saddle of lamb on the bone, approx. 1 kg	Ovenware without lid, Wire rack	1		190-210	-	40-50
Leg of lamb, boned, medium, approx. 1.5 kg	Ovenware with lid, Wire rack	1		180-200	-	90-100
Saddle of venison on the bone, approx. 1 kg	Ovenware with lid, Wire rack	1		210-220	-	40-50
Boned leg of roe venison, approx. 1.5 kg	Ovenware with lid, Wire rack	1		180-190	-	105-120
Wild boar joint, approx. 1.5 kg	Ovenware with lid, Wire rack	1		200-220	-	100-110
Joint of venison, approx. 1.5 kg	Ovenware with lid, Wire rack	1		200-220	-	90-100
Rabbit, approx. 1.5 kg	Ovenware with lid, Wire rack	1		200-220	90 W	25-35

### Miscellaneous

#### Notes

- Finally, allow the meat loaf to stand for approx. a further 10 minutes.
- Turn the sausages after  $\frac{2}{3}$  of the cooking time.

- Hot air grilling
- Grill, large area















Miscellaneous	Accessories	Level	Type of heating	Temperature in °C, grill setting	Microwave power in watts	Cooking time in minutes
Meat loaf made from approx. 1 kg of meat	Ovenware without lid, wire rack	1		170-190	600 W + 180 W	10 mins + 40-50 mins
4 to 6 grilled sausages, approx. 150 g each	Universal pan + Wire rack	1 3		3	-	1st side: approx. 10-15 2nd side: approx. 5-10

### Poultry

#### Notes

- Place whole chickens, chicken breasts and small turkeys breast-side down. Turn after  $\frac{2}{3}$  of the cooking time.
- Place poulard breast-side down. Turn after  $\frac{2}{3}$  of the cooking time and set the microwave power to 180 watts.
- Place half chickens and chicken portions skin-side up. Do not turn.
- Turn duck and goose after  $\frac{1}{3}$  and  $\frac{2}{3}$  of the cooking time.
- Place duck and goose breast skin-side down. Turn halfway through the cooking time.
- Turn goose legs halfway through the cooking time. Prick the skin.

- Turn rolled turkey joints after  $\frac{2}{3}$  of the cooking time.
- Place turkey breast and thighs skin-side down. Turn after  $\frac{2}{3}$  of the cooking time.
- Hot air grilling
- Grill, large area
- Hot air
- Top/bottom heating



Poultry	Accessories	Level	Type of heating	Temperature in °C, grill setting	Microwave power in watts	Cooking time in minutes
Chicken, whole, approx. 1.2 kg	Ovenware with lid, wire rack	1		230-250	360 W	25-35
Poulard, whole	Ovenware with lid, wire rack	1		200-220	360 W 180 W	30 15-25
Chicken halves, 500 g each	Ovenware without lid, wire rack	1		180-200	360 W	30-35
Chicken portions, approx. 800 g	Ovenware without lid, wire rack	1		190-210	360 W	30-35
Chicken portions, approx. 1.5 kg	Ovenware without lid, wire rack	1		190-210	360 W	35-40
Chicken breast approx. 500 g	Ovenware without lid, wire rack	1		190-210	180 W	25-30
Duck, whole, 1.5 to 1.7 kg	Universal pan	1		170-190	180 W	60-80
Duck breast, whole, 2 pieces, 300 to 400 g each	Wire rack + Universal pan*	2 1		3	90 W	18-22
Goose, whole, 3 to 3.5 kg	Universal pan	1		170-190	180 W	80-90
Goose breast, 2 pieces, 500 g each	Wire rack + Universal pan*	2 1		210-230	90 W	20-25
4 goose legs, approx. 1.5 kg	Wire rack + Universal pan*	2 1		170-190	180 W	30-40
Small turkey, whole, approx. 3 kg	Universal pan	1		170-180	180 W	60-70
Rolled turkey joint, approx. 1.5 kg	Ovenware with lid, wire rack	1		190-200	180 W	60-70
Turkey breast, approx. 1 kg	Ovenware with lid, wire rack	1		200-210	-	80-90
Turkey drumsticks, approx. 1.3 kg	Ovenware with lid, wire rack	1		210-230	360 W	45-50



\* Add 50 ml of water to the universal pan.

## Fish

### Notes

- For grilling, place the whole fish, e.g. trout, onto the middle of the wire rack.
- For braised fish, cook the whole fish in its swimming position.

-  Grill, small area
-  Grill, large area

Fish	Accessories	Level	Type of heating	Grill setting	Microwave power in watts	Cooking time in minutes
Whole fish, e.g. trout approx. 300 g, grilled	Universal pan + Wire rack*	1 3		2	-	1st side: approx. 10-15 2nd side: approx. 8-12
Fish steak, e.g. salmon 3 cm thick, grilled	Universal pan + Wire rack*	1 3		3	-	1st side: approx. 10-12 2nd side: approx. 8-12
2 or 3 whole fish, 300 g each, grilled	Universal pan + Wire rack*	1 3		2	-	1st side: approx. 10-15 2nd side: approx. 10-15
Whole fish, approx. 1 kg, braised	Ovenware with lid, wire rack	1	-	-	600 W	10-15
Whole fish, approx. 1.5 kg, braised	Ovenware with lid, wire rack	1	-	-	600 W 360 W	10-15 5-10
Whole fish, approx. 2 kg, braised	Ovenware with lid, wire rack	1	-	-	600 W 360 W	15-20 10-15
Fish fillet, e.g. pollock, approx. 800 g, braised	Ovenware with lid, wire rack	1	-	-	600 W	9-14

\* Grease the wire rack first with oil.

## Tips for roasting and grilling





The table does not contain information for the weight of the joint.









For small roasts, select a higher temperature and a shorter cooking time. For larger roasts, select a lower temperature and a longer cooking time.

How to tell when the roast is ready.	Use a meat thermometer (available from specialist shops) or carry out a "spoon test". Press down on the roast with a spoon. If it feels firm, it is ready. If the spoon can be pressed in, it needs to be cooked for a little longer.
The roast looks good but the juices are burnt.	Next time, use a smaller roasting dish or add more liquid.
The roast looks good but the juices are too clear and watery.	Next time, use a larger roasting dish and add less liquid.
The roast is not well-done enough.	Carve the roast. Prepare the gravy in the roasting dish and place the slices of roast meat in the gravy. Finish cooking the meat using the microwave only.

## Bakes, gratins, toast with toppings



### Notes









- The values in the table apply to food placed in a cold oven.
- Use large flat ovenware for bakes and gratins. Food takes longer to cook in narrow, deep containers and browns more on top.
- Place the bake in microwaveable ovenware on the wire rack.
- Leave bakes and gratins to cook in the oven for a further 5 minutes after switching off.
- Use a 4 to 5 cm deep ovenproof dish for bakes, potato gratins and lasagne.
- Place soufflés in individual moulds or in a deep ovenproof dish. Preheat the cooking compartment.
- Toast with topping: lay 4 slices next to each other in the centre of the universal pan. Distribute 12 slices evenly over the universal pan.
-  Hot air grilling
-  Hot air
-  Top/bottom heating
-  Grill, small area
-  Grill, large area

Bakes, gratins, toast with toppings	Accessories	Level	Type of heating	Temperature in °C, grill setting	Microwave power in watts	Cooking time in minutes
Bake, sweet, approx. 1.5 kg	Ovenware with lid, Wire rack	1		140-160	360 W	25-35
Soufflé	Ovenware without lid, Wire rack	1		160-180	-	40-45
Soufflé in individual moulds	Wire rack	1		200-210	-	12-17
Pasta bake, approx. 1 kg	Ovenware without lid, Wire rack	1		140-160	600 W	20-30
Lasagne, approx. 2 kg	Ovenware without lid, Wire rack	2		180-200	600 W	20-30
Potato gratin made from raw ingredients, approx. 1.1 kg	Ovenware without lid, Wire rack	1		170-190	600 W	20-25
Toast with topping, 4 slices	Universal pan	2		3	-	8-13
Toast with topping, 12 slices	Universal pan	2		3	-	9-14

## Convenience products

### Notes

- Please observe the instructions on the packaging.
- The values in the table apply to food placed in a cold oven.
- Do not lay chips, croquettes or potato röstis on top of each other.
- Turn fish fingers, chicken goujons, nuggets and veggie burgers halfway through the cooking time.
- Place cream gateau on the oven floor without accessories, level 0.
-  Top/bottom heating
-  Hot air
-  Hot air grilling

Convenience products	Accessories	Level	Type of heating	Temperature °C	Microwave power in watts	Cooking time in minutes
Pizza with thin base	Universal pan	1		210-230	-	20-25
Pizza with deep-pan base	Universal pan	2		200-220	90 W	15-25
Mini pizza	Universal pan	2		210-230	-	15-20
Pizza baguette	Universal pan	2		180-190	-	15-20
Chips	Universal pan	2		220-230	-	20-25
Croquettes	Universal pan	2		200-220	-	25-35
Rösti, stuffed potato pockets	Universal pan	2		200-220	-	25-35
Bread rolls, baguette	Wire rack	2		200-220	-	15-20

\* Line the universal pan with greaseproof paper.

The greaseproof paper must be suitable for these temperatures.

Convenience products	Accessories	Level	Type of heating	Temperature °C	Microwave power in watts	Cooking time in minutes
Pretzels, dough	Universal pan*	2		190-210	-	20-25
Part-cooked rolls or baguette	Wire rack	2		140-150	-	12-15
Fish fingers	Universal pan	2		190-210	180 W	10-15
Chicken goujons, nuggets	Universal pan	2		190-210	360 W	15-20
Veggie burgers	Universal pan	2		200-220	180 W	15-25
Strudel	Universal pan	2		200-220	90 W	20-25
Lasagne	Wire rack	2		200-210	180 W	18-23
Cream gateau	-	0		30	-	120-150

\* Line the universal pan with greaseproof paper.

The greaseproof paper must be suitable for these temperatures.

## Slow cooking

Slow cooking, also known as low-temperature cooking, is the ideal cooking method for all tender pieces of meat which are to be cooked medium rare or "à point". Meat remains very succulent and tender. The benefit of this cooking method is that it allows lots of scope for menu planning because slow-cooked meat is easy to keep warm.

### Setting the Slow cook option

Use shallow ovenware, e.g. a serving dish made out of porcelain or a glass roasting dish with a lid. Always place the ovenware with lid on the wire rack at level 1.

1. Select Slow cook and a temperature between 70 and 100 °C. Preheat the cooking compartment, thus warming the ovenware at the same time.
2. Rapidly heat a little fat in a pan. Sear the meat on all sides, even on the ends, and place immediately on the preheated ovenware.
3. Place the ovenware in the cooking compartment and restart the appliance.

#### Notes

- Only use fresh, good-quality meat. Carefully remove sinews and fat from around the edge. Fat develops a strong, distinct taste during slow cooking.
- All tender joints of poultry, beef, veal, pork and lamb are suitable for slow cooking. Searing and cooking times depend on the size of the piece of meat.
- Sear the meat at a very high heat and for a sufficiently long time on all sides, even on the ends.
- In order to check whether the meat is cooked, use a meat thermometer. A core temperature of 60 °C should be maintained for at least 30 minutes.
- You can also slow cook your meat in ovenware without a lid. The cooking times will be increased.
- Even large joints of meat do not need to be turned.
- You can cut the meat immediately after slow cooking. No standing time is required.
- Due to the special cooking method, the meat always looks pink on the inside. This does not mean, however, that it is raw or not well done enough.

#### Slow cooking

**Note:** Use ovenware with a properly fitting, matching lid, e.g. a glass roasting dish. Place the roasting dish on the wire rack.

Slow cook

Slow cooking	Level	Type of heating	Temperature °C	Cooking time in minutes
<b>Poultry</b>				
Turkey breast	1		80	240-270
Skinless duck breast	1		80	110-140
<b>Beef</b>				
Beef joint (e.g. rump)	1		80	270-300
Fillet of beef	1		80	150-180
Sirloin	1		80	180-220
Beef steaks, 3 cm thick	1		80	70-100
<b>Veal</b>				
Joint of veal (e.g. veal olive)	1		80	180-220
Fillet of veal	1		80	80-100
<b>Pork</b>				
Joint of pork (e.g. loin)	1		80	180-210
Pork fillet	1		80	140-170
<b>Lamb</b>				
Lamb fillet	1		80	40-70

### Tips for slow cooking

Slow-cooked meat is not as hot as conventionally roasted meat. So that the roasted meat does not cool too fast, warm the plates and serve the gravy very hot.

If you wish to keep slow-cooked meat warm. After slow cooking, turn the temperature down to 70 °C. Small pieces of meat can be kept warm for up to 45 minutes, larger pieces for up to 2 hours.

# Test dishes

The quality and function of microwave combination appliances are tested by testing institutes using the following dishes.

According to the standards EN 60705, IEC 60705/DIN 44547 and EN 60350 (2009)

## Defrosting with the microwave

Dish	Microwave power setting in watts, cooking time in minutes	Note
Meat	180 W, 5 mins + 90 W, 10-15 mins	Place 22 cm Pyrex dish on the wire rack at level 1. After approx. 10 minutes, remove the defrosted meat.



## Microwave cooking

Dish	Microwave power setting in watts, cooking time in minutes	Note
Custard	360 W, 10 mins + 180 W, 20-25 mins	Place Pyrex dish on the wire rack at level 1.
Sponge	600 W, 8-10 mins	Place 22 cm Pyrex dish on the wire rack at level 1.
Meat loaf	600 W, 20-25 mins	Place Pyrex dish on the wire rack at level 1.

■  Hot air grilling

■  Top/bottom heating

## Combined microwave cooking





Dish	Microwave power setting in watts, cooking time in minutes	Type of heating	Temperature °C	Note
Potato gratin	600 W, 20-25 mins		170-190	Place 22 cm Pyrex dish on the wire rack at level 1.
Cake	180 W, 15-20 mins		180-200	Place 22 cm pyrex dish on the wire rack at level 1.
Chicken*	360 W, 30-35 mins		200-220	Turn after 15 minutes.











\* Slide the wire rack in at level 2 and the universal pan in at level 1.

## Baking

### Notes

- The values in the table apply to food placed in a cold oven.
- Apple pie: place the dark springform cake tins diagonally alongside one another.

-  Top/bottom heating
-  Hot air
-  3D hot air
-  Intensive heat



	Ovenware	Level	Type of heating	Temperature °C	Baking time in minutes
Viennese whirls	Universal pan	2		160-180	20-30
	Universal pan	2		150-170	20-30
	Universal pan* + Enamel baking tray**	1 3		140-150	30-40
Small cakes	Universal pan	2		160-180	25-35
	Universal pan	2		140-160	25-35
Small cakes	Universal pan* + Enamel baking tray**	1 3		150-170	35-45
Hot water sponge cake	Springform cake tin on the wire rack	1		160-170	30-40
Yeast cakes on a baking tray	Universal pan	2		170-190	45-55
	Universal pan* + Enamel baking tray**	1 3		160-180	50-60
	Apple pie	2 x 20 cm springform cake tins on the wire rack	2		170-190

\* When baking on two levels, always slide in the enamel baking tray above the universal pan.

\*\* Enamel baking trays can be obtained as an optional accessory from specialist retailers.

## Grilling

 Grill, large area

Dish	Accessories	Level	Type of heating	Grill setting	Cooking time in minutes
Toasting bread*	Wire rack	3		3	1-2
12 beefburgers**	Wire rack and Universal pan	3 1		3	30

\* Preheat for 5 minutes.

\*\* Turn halfway through the cooking time.

---

## Acrylamide in foodstuffs

### Which foods are affected?

Acrylamide is mainly produced in grain and potato products that are heated to high temperatures, such as potato crisps,

chips, toast, bread rolls, bread, fine baked goods (biscuits, gingerbread, cookies).

---

### Tips for keeping acrylamide to a minimum when preparing food

General	Keep cooking times to a minimum. Cook meals until they are golden brown, but not too dark. Large, thick pieces of food contain less acrylamide.
Baking biscuits	Max. 200 °C in Top/bottom heating or max. 180 °C in 3D hot air or hot air mode. Max. 190° C in Top/bottom heating or max. 170 °C in 3D hot air or hot air mode. Egg white and egg yolk reduce the formation of acrylamide.
Oven chips	Distribute thinly and evenly over the baking tray. Cook at least 400 g at once on a baking tray so that the chips do not dry out.





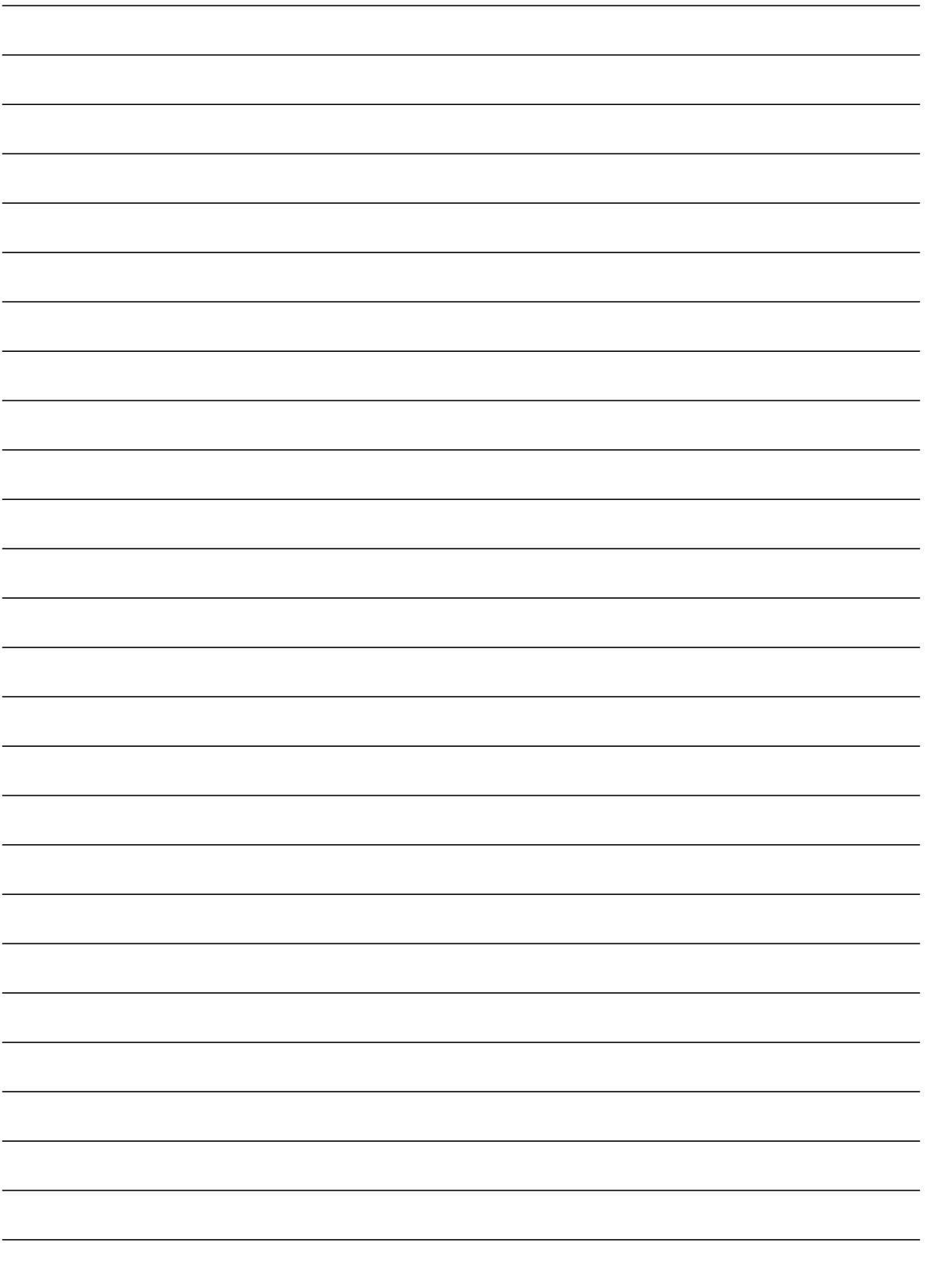

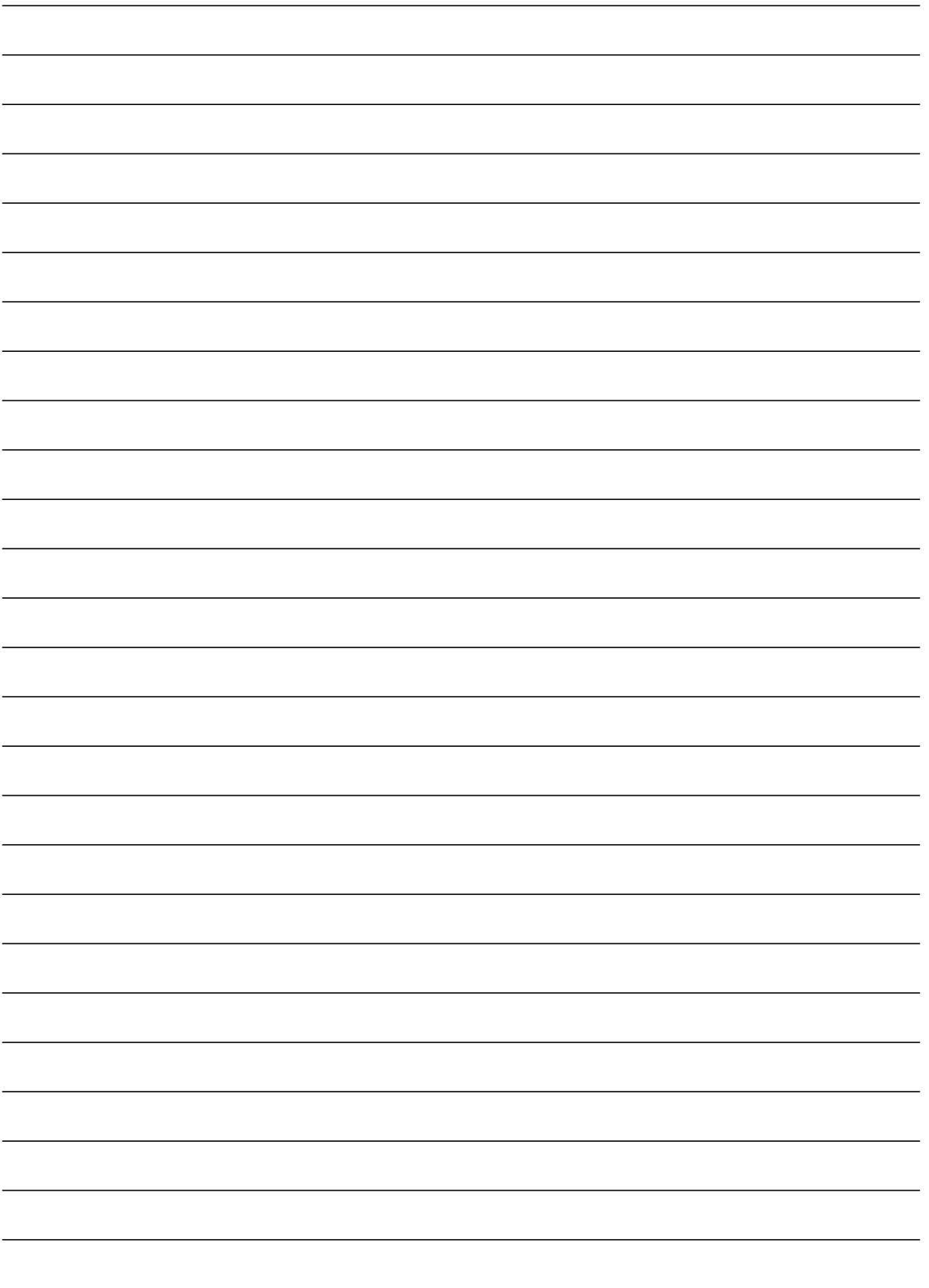

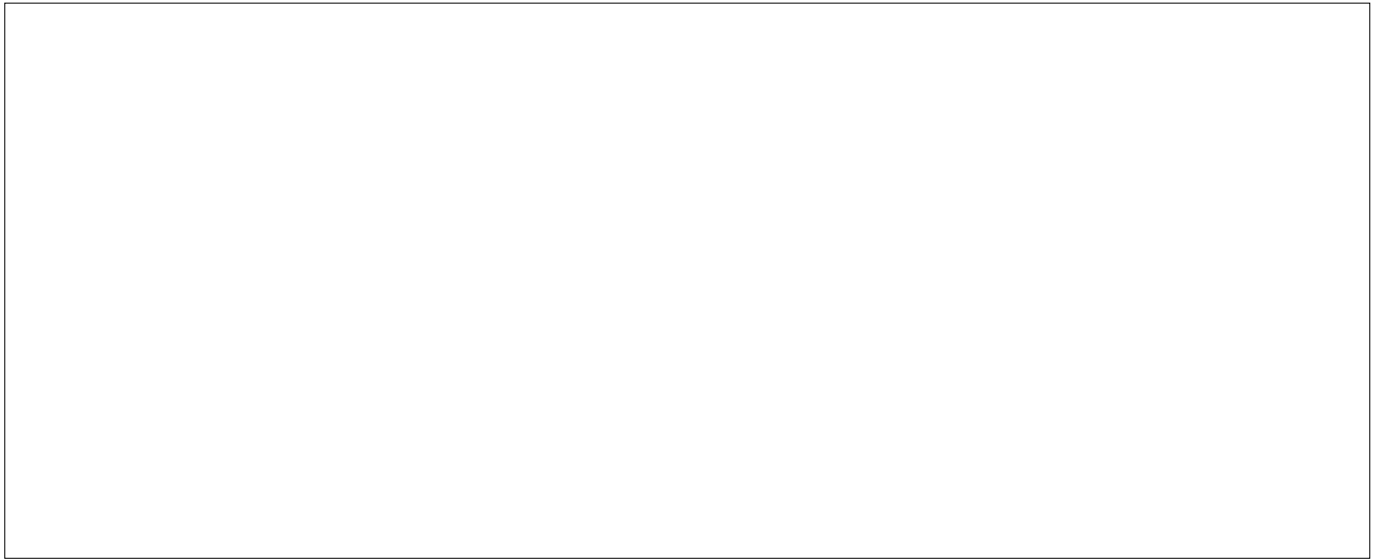

**Robert Bosch Hausgeräte GmbH**

Carl-Wery-Straße 34

81739 München

Germany

**[www.bosch-home.com](http://www.bosch-home.com)**



9000728108