

## Safety instructions

- The washing machine is heavy – take care when lifting it.
- Warning: frozen hoses may tear/burst. Do not install the washing machine outdoors or in areas where there is a risk of frost.
- The washing machine may be damaged. Do not lift the machine by any of its projecting parts (e.g. the washing machine door).
- In addition to the instructions mentioned here, special regulations regarding the relevant water and power supply companies may apply.
- If in doubt, have the appliance connected by a technician.
- Lay hoses and cables in such a way that there is no risk that they can be tripped over.

## Environmentally-friendly disposal

- Dispose of packaging in an environmentally friendly manner.
- This appliance has been identified in accordance with the European Directive 2012/19/EU on Waste Electrical and Electronic Equipment (WEEE). This directive specifies a framework for the return and recycling of waste appliances, and is valid throughout Europe.

## Scope of delivery according to the model

Humidity in the drum is caused by the final inspection.

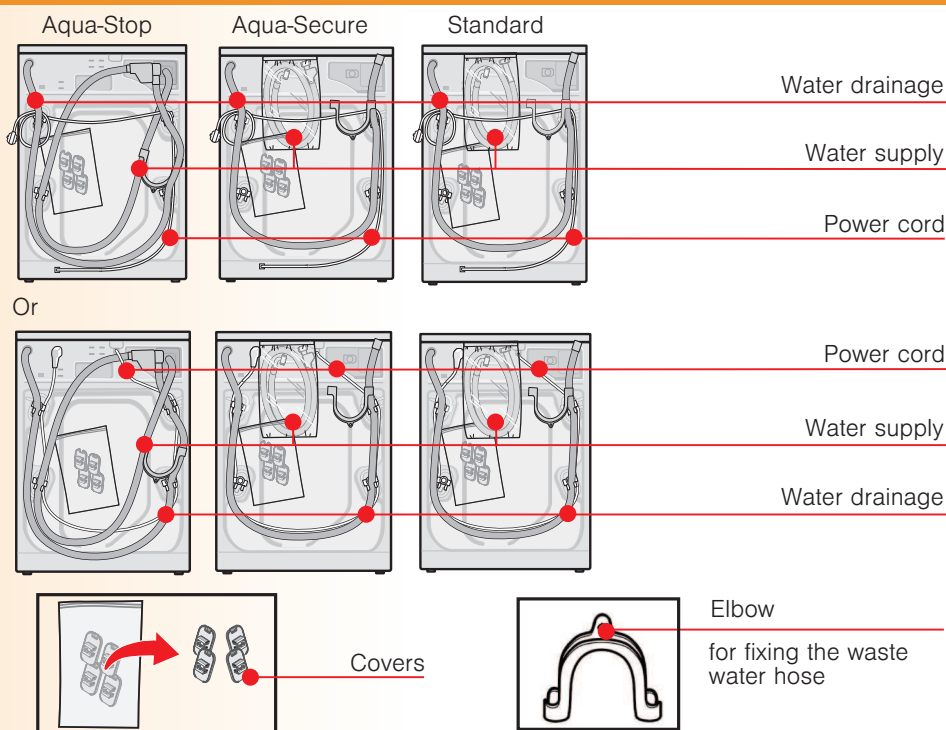

### Depending on the connection

- A 24-40 mm dia. hose clip may also be required for connecting the siphon (available from specialist retailers) → Page 4: **Water connection**.

### Useful tool

- Spirit level for aligning the washing machine.

1

## Installation area

- Stability is important to prevent the machine from wandering.
- The installation area must be firm and level.
- Soft floors/floor coverings such as e.g. carpets are not suitable.

### If installing the appliance on a wooden joist floor

- If possible, install the washing machine in a corner.
- Screw a water-resistant wooden panel (min. 30 mm thick) to the floor.
- It is **essential** to secure the washing machine feet using holding brackets\*.  
\*order no. WMZ 2200, WX 9756

## Hose and cable lengths depending on the model

### Connection on left side or Connection on right side

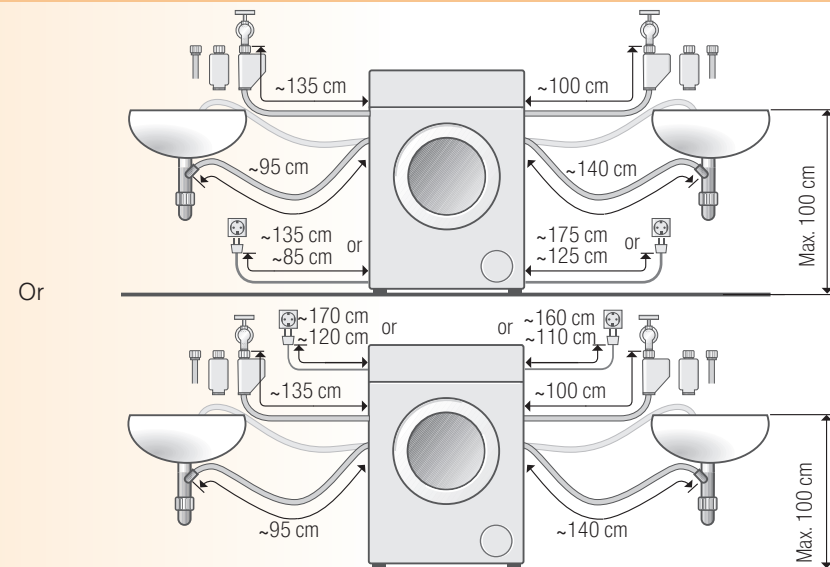

- Note: The lengths of power cord depends on the type of plug.  
Available from dealer/after-sales service:
- Aqua-Stop extension hose\*\*, approx. 2.50 m.
  - Longer supply hose, approx. 2.20 m, for standard model.
- \*\*order no. WMZ 2380, WZ 10130

## Built-under/built-in appliances

Build these appliances under/in before connection to the power supply.

### Installed in between kitchen units (built-under or built-in)

- 60 cm cavity width required.
- Install the washing machine only under a continuous worktop that is connected firmly to the adjacent cupboards.

2

## Removing the transport bolts

- Before using the appliance for the first time, always remove and retain all 4 transport bolts.
- If transporting the appliance subsequently, always re-install the transport bolts - this prevents damage to the machine → Page 6.
- Retain the screw and spacer.

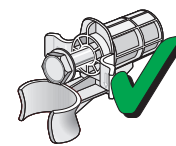

1. Take the hoses (depending on the model) out of the holder and the elbow. Remove the elbow.

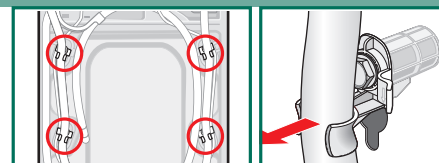

2. Undo and remove all 4 transport bolts.

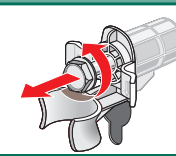

3. Take the power cord out of the holders. Remove the sleeves.

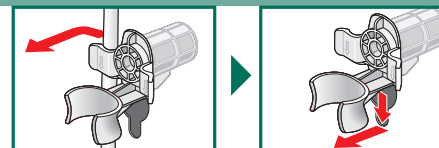

4. Insert the covers and lock them in place by pressing on the locking hook.

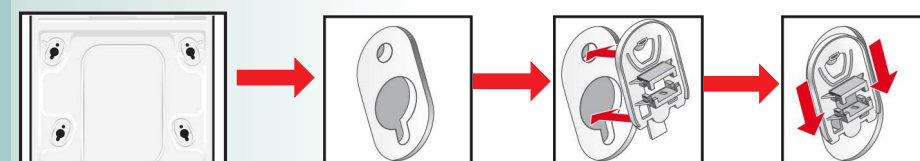

3

## Water connection

depending on the model

- Risk of electric shock. Do not immerse the Aqua-Stop safety device in water (contains an electric valve).
- To prevent leakage or water damage, follow the instructions in this chapter.
- **Note:** Operate the washing machine with cold drinking water only. Do not connect to the mixer tap of a pressureless hot-water heater.
- Do not use a used inlet hose. Only use the inlet hose supplied or one which was purchased from an authorised specialist dealer.
- If in doubt, have the appliance connected by a technician.

### Water supply

**Water inlet hose:**

- **Note:** Do not bend, crush, modify or cut through the hose (the strength is no longer guaranteed).

**Optimum water pressure in the mains: 100-1000 kPa (1-10 bar)**

- When the tap is turned on, the water flow is at least 8 l/min.
- If the water pressure is higher, install a pressure reducing valve.

1. Connect the water supply hose to the tap. Tighten the plastic screw fittings by hand only.

**Model:** Aqua-Stop Aqua-Secure Standard

Max. 90° Max. 90°

min 10 mm min 10 mm

min 10 mm min 10 mm

2. Carefully turn on the tap and check that the connection points are not leaking. **Note:** The screw connection is under water mains pressure.

### Water drainage

**Water drainage hose:**

- Note:** Do not kink or stretch.

**Height difference between the installation area and outlet:**  
0 - 100 cm

#### Drainage into a sink/bath tub:

**Note:** Secure the drainage hose to prevent it from slipping out of the sink.

**Note:** The plug must not be in the plug hole. When the water is being pumped out of the washing machine, check that the water drains away quickly enough. Do not immerse the end of the drainage hose in the water that has been pumped out. There is a risk that water will be drawn back into the washing machine.

#### Drainage into a siphon:

**Note:** Secure the connection with a 24-40 mm dia. hose clip (available from a specialist retailer).

#### Drainage into a plastic pipe with rubber sleeve:

**Note:** Secure the drainage hose to prevent it from slipping out of the drain.

4

## Alignment

 High levels of noise, intense vibrations and "wandering" may occur due to incorrect alignment.

### Aligning the washing machine with a spirit level.

1. Undo the lock nut in a clockwise direction using a wrench.
2. Adjust the height by adjusting the appliance foot. All four appliance feet must be placed firmly on the floor. The washing machine must not be able to wobble. Use a spirit level to check the alignment of the washing machine and correct it if necessary.
3. Tighten the lock nut against the housing. The lock nuts on all four appliance feet must be screwed tightly against the housing.

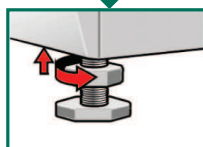
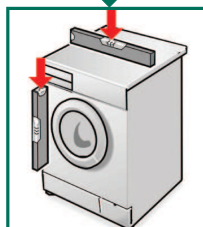
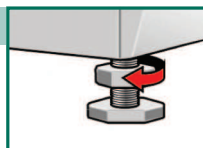

## Electrical connection

- Connect the washing machine to an alternating current and only use a properly installed and grounded socket.
- The mains voltage and specifications on the washing machine must match → Page 6: Technical specifications.
- For information about the connected load and required fuse, see → Page 6: Technical specifications.
- Ensure that:
  - the main plug fits into the socket outlet,
  - the cable cross-section is adequate,
  - the earthing system has been installed correctly.
- A damaged power cord must be replaced by an electrician only. Replacement power cords are available from after-sales service.
- Do not use multiple plugs/connectors or extension cables.
- If a residual current operated circuit-breaker is used, use only a type which features this symbol  : Only this symbol guarantees compliance with the currently valid regulations.
- Mains plug:
  - Do not insert into/pull out of the socket with damp hands.
  - do not pull the plug out of the socket by pulling on the power cord.
  - never pull out the plug while the appliance is in operation.

## Transportation, e.g. when moving house

### 1. Before transporting the washing machine:

1. Turn off the tap/water supply.
2. Release the water pressure in the supply hose. → Operating instructions, Page 11: Filter in the water inlet hose.
3. Drain any residual detergent solution. → Operating instructions, Page 11: Drain pump.
4. Disconnect the washing machine from the power supply.
5. Remove the hoses.

### 2. Installing transport bolts:

1. Remove the covers.
2. Insert all 4 spacers. Clamp the power cord into the holders. Insert and tighten the screws.

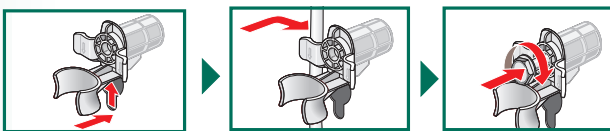

The transport bolts **must** be removed after transportation. → Page 3.



To prevent unused detergent from flowing into the outlet during the next wash: Pour 1 litre of water into dispenser II and start the **Drain** or **Spin** programme.

## Technical specifications

|  |  |
|--|--|
| ● <b>Dimensions (width x depth x height)</b> | WS, WLO and WLM: 60 x 45 x 85 cm<br>WM, WAP and WAS: 60 x 59 x 85 cm             |
| ● <b>Weight</b>                              | WS, WLO and WLM: 64 kg<br>WM, WAP and WAS: 77 kg                                 |
| ● <b>Power supply</b>                        | Nominal voltage 220-240 V, 50 Hz<br>Nominal current 10 A<br>Nominal power 2300 W |
| ● <b>Water pressure</b>                      | 100-1000 kPa (1-10 bar)  |
| ● <b>Test programmes</b>                     | Compliant with currently valid European Standard 60456                           |

## Aqua-Stop warranty for appliances with Aqua-Stop only

In addition to warranty claims against the seller based on the contract of sale and in addition to our appliance warranty, we shall pay damages under the following conditions:

1. If water damage was caused by a fault in our Aqua-Stop system, we shall compensate private users for damage.
2. The liability warranty applies to the service life of the appliance.
3. A claim can only be made under the warranty if the appliance and Aqua-Stop have been correctly installed and connected according to our instructions; this also includes a correctly installed Aqua-Stop extension (genuine accessory). Our warranty does not extend to defective supply lines or fittings up to the Aqua-Stop connection on the tap.
4. Appliances which feature Aqua-Stop can be left unattended during operation and it is not necessary to turn off the tap afterwards. The tap should only be turned off if you are away for a prolonged period, e.g. several weeks holiday.

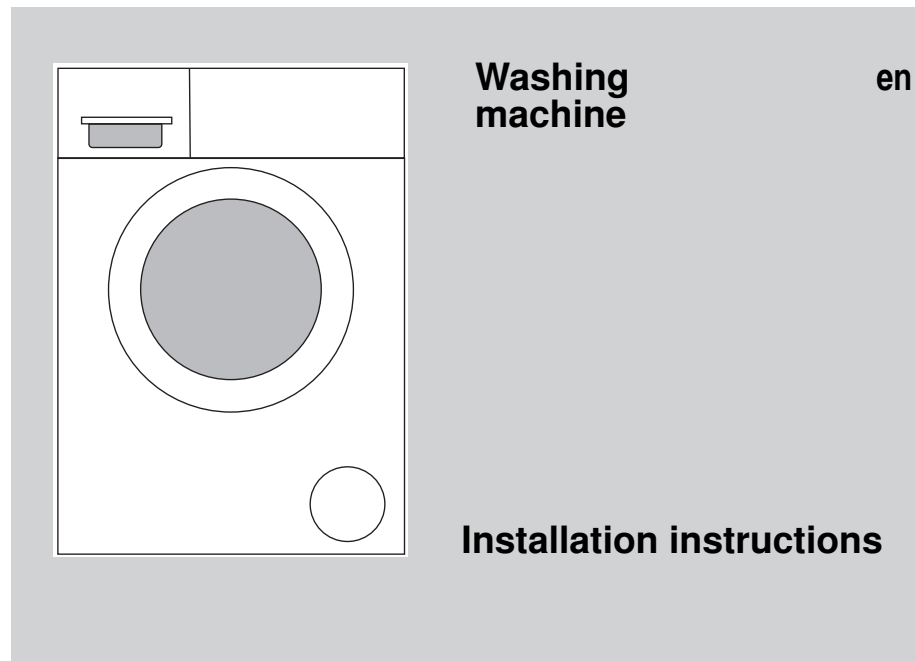

## Contents

|  | Page |
|--|------|
| ■ Safety instructions . . . . .                  | 1    |
| ■ Environmentally-friendly disposal . . . . .    | 1    |
| ■ Scope of delivery . . . . .                    | 1    |
| ■ Installation area . . . . .                    | 2    |
| ■ Hose and cable lengths . . . . .               | 2    |
| ■ Built-under/built-in appliances . . . . .      | 2    |
| ■ Removing the transport bolts . . . . .         | 3    |
| ■ Water connection . . . . .                     | 4    |
| ■ Alignment . . . . .                            | 5    |
| ■ Electrical connection . . . . .                | 5    |
| ■ Transportation, e.g. if moving house . . . . . | 6    |
| ■ Technical specifications . . . . .             | 6    |
| ■ Aqua-Stop warranty . . . . .                   | 7    |



**Read these instructions before switching on the washing machine. Also follow the separate Operating instructions. Retain all documents for subsequent use or for the next owner.**





## Safety instructions

- The washing machine is heavy – take care when lifting it.
- Warning: frozen hoses may tear/burst. Do not install the washing machine outdoors or in areas where there is a risk of frost.
- The washing machine may be damaged. Do not lift the machine by any of its projecting parts (e.g. the washing machine door).
- In addition to the instructions mentioned here, special regulations regarding the relevant water and power supply companies may apply.
- If in doubt, have the appliance connected by a technician.
- Lay hoses and cables in such a way that there is no risk that they can be tripped over.

## Environmentally-friendly disposal



- Dispose of packaging in an environmentally friendly manner.
- This appliance has been identified in accordance with the European Directive 2012/19/EU on Waste Electrical and Electronic Equipment (WEEE). This directive specifies a framework for the return and recycling of waste appliances, and is valid throughout Europe.

## Scope of delivery according to the model

Humidity in the drum is caused by the final inspection.

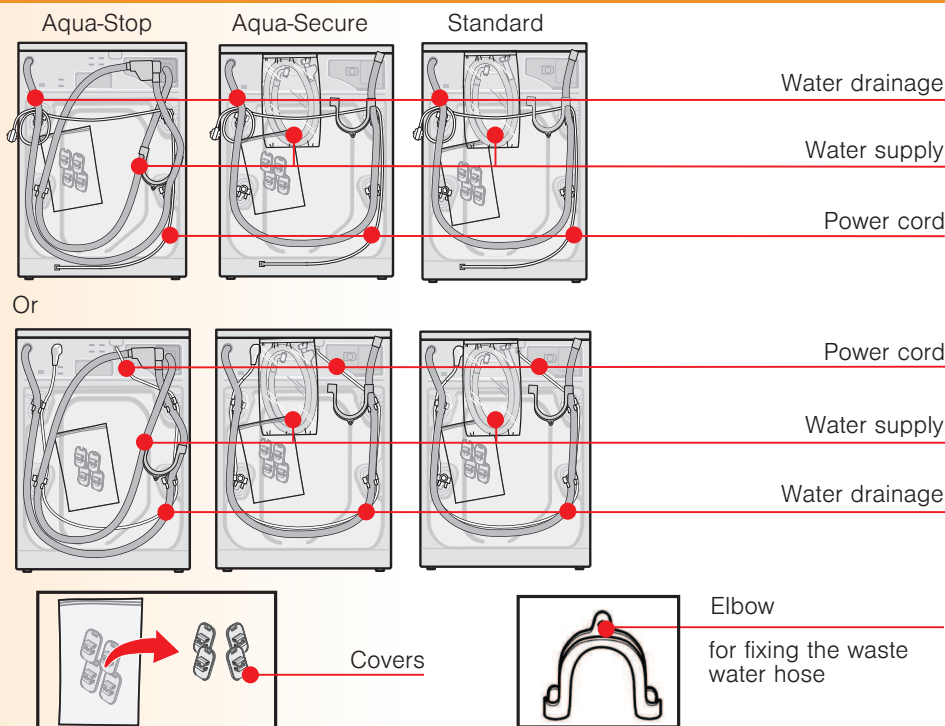

### Depending on the connection

- A 24-40 mm dia. hose clip may also be required for connecting the siphon (available from specialist retailers) → Page 4: **Water connection**.

### Useful tool

- Spirit level for aligning the washing machine.

## Installation area



- Stability is important to prevent the machine from wandering.
- The installation area must be firm and level.
- Soft floors/floor coverings such as e.g. carpets are not suitable.



### If installing the appliance on a wooden joist floor

- If possible, install the washing machine in a corner.
  - Screw a water-resistant wooden panel (min. 30 mm thick) to the floor.
  - It is **essential** to secure the washing machine feet using holding brackets\*.
- \*order no. WMZ 2200, WX 9756

## Hose and cable lengths depending on the model



### Connection on left side

or

### Connection on right side

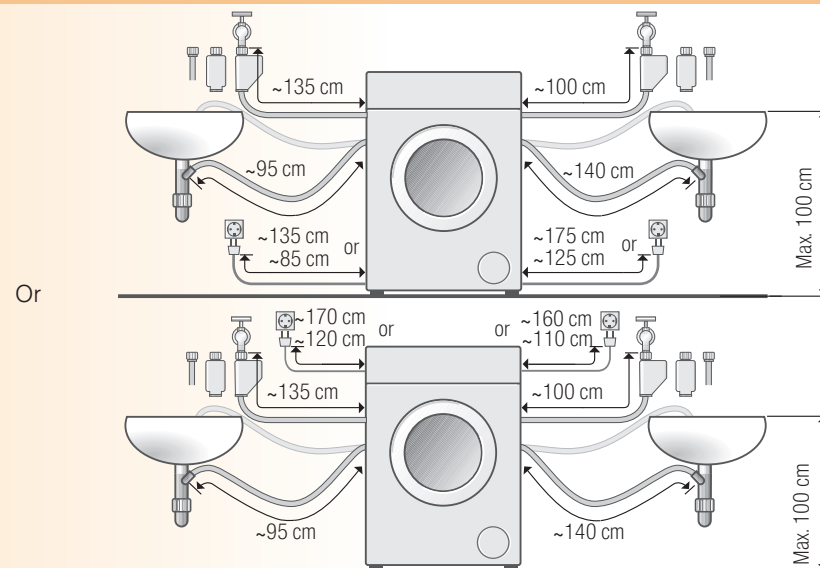

Note: The lengths of power cord depends on the type of plug.

Available from dealer/after-sales service:

- Aqua-Stop extension hose\*\*, approx. 2.50 m.
- Longer supply hose, approx. 2.20 m, for standard model.

\*\*order no. WMZ 2380, WZ 10130

## Built-under/built-in appliances



Build these appliances under/in before connection to the power supply.



### Installed in between kitchen units (built-under or built-in)

- 60 cm cavity width required.
- Install the washing machine only under a continuous worktop that is connected firmly to the adjacent cupboards.

## Removing the transport bolts



- Before using the appliance for the first time, always remove and retain all 4 transport bolts.
- If transporting the appliance subsequently, always re-install the transport bolts - this prevents damage to the machine → Page 6.
- Retain the screw and spacer.

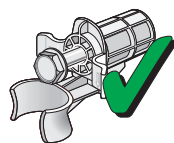

1. Take the hoses (depending on the model) out of the holder and the elbow. Remove the elbow.

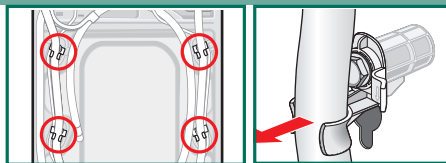

2. Undo and remove all 4 transport bolts.

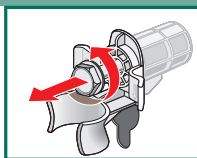

3. Take the power cord out of the holders. Remove the sleeves.

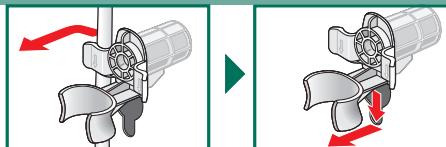

4. Insert the covers and lock them in place by pressing on the locking hook.

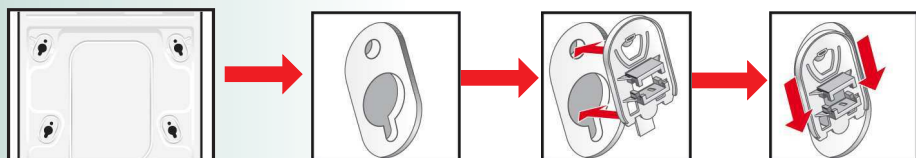

## Water connection

depending on the model



- Risk of electric shock. Do not immerse the Aqua-Stop safety device in water (contains an electric valve).
- To prevent leakage or water damage, follow the instructions in this chapter.
- **Note:** Operate the washing machine with cold drinking water only. Do not connect to the mixer tap of a pressureless hot-water heater.
- Do not use a used inlet hose. Only use the inlet hose supplied or one which was purchased from an authorised specialist dealer.
- If in doubt, have the appliance connected by a technician.



### Water supply

#### Water inlet hose:

- **Note:** Do not bend, crush, modify or cut through the hose (the strength is no longer guaranteed).

#### Optimum water pressure in the mains: 100-1000 kPa (1-10 bar)

- When the tap is turned on, the water flow is at least 8 l/min.
- If the water pressure is higher, install a pressure reducing valve.

**Model:** Aqua-Stop Aqua-Secure      Standard

1. Connect the water supply hose to the tap. Tighten the plastic screw fittings by hand only.

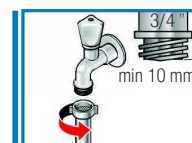
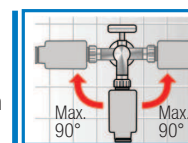

2. Carefully turn on the tap and check that the connection points are not leaking.

**Note:** The screw connection is under water mains pressure.

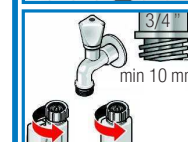

### Water drainage

#### Water drainage hose:

**Note:** Do not kink or stretch.

**Height difference between the installation area and outlet:**  
0 - 100 cm

#### Drainage into a sink/bath tub:

**Note:** Secure the drainage hose to prevent it from slipping out of the sink.

**Note:** The plug must not be in the plug hole. When the water is being pumped out of the washing machine, check that the water drains away quickly enough. Do not immerse the end of the drainage hose in the water that has been pumped out. There is a risk that water will be drawn back into the washing machine.

#### Drainage into a siphon:

**Note:** Secure the connection with a 24-40 mm dia. hose clip (available from a specialist retailer).

#### Drainage into a plastic pipe with rubber sleeve:

**Note:** Secure the drainage hose to prevent it from slipping out of the drain.

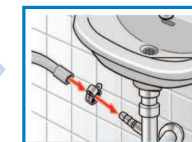
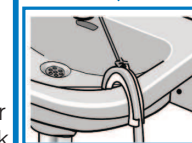
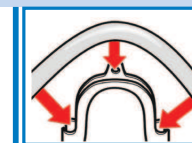

## Alignment

 High levels of noise, intense vibrations and “wandering” may occur due to incorrect alignment.

### Aligning the washing machine with a spirit level.

1. Undo the lock nut in a clockwise direction using a wrench.
2. Adjust the height by adjusting the appliance foot.  
*All four appliance feet must be placed firmly on the floor. The washing machine must not be able to wobble. Use a spirit level to check the alignment of the washing machine and correct it if necessary.*
3. Tighten the lock nut against the housing.  
*The lock nuts on all four appliance feet must be screwed tightly against the housing.*

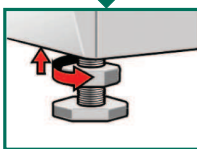
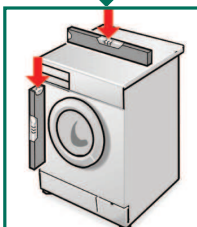
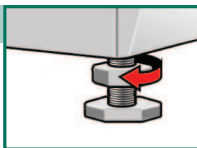

## Electrical connection

- Connect the washing machine to an alternating current and only use a properly installed and grounded socket.
- The mains voltage and specifications on the washing machine must match → Page 6: Technical specifications.
- For information about the connected load and required fuse, see → Page 6: Technical specifications.
- Ensure that:
  - the main plug fits into the socket outlet,
  - the cable cross-section is adequate,
  - the earthing system has been installed correctly.
- A damaged power cord must be replaced by an electrician only. Replacement power cords are available from after-sales service.
- Do not use multiple plugs/connectors or extension cables.
- If a residual current operated circuit-breaker is used, use only a type which features this symbol  :  
Only this symbol guarantees compliance with the currently valid regulations.
- Mains plug:
  - Do not insert into/pull out of the socket with damp hands.
  - do not pull the plug out of the socket by pulling on the power cord.
  - never pull out the plug while the appliance is in operation.

Manufacturer (see Operating instructions)

9402 / 9000 709852

5

## Transportation, e.g. when moving house

### 1. Before transporting the washing machine:

1. Turn off the tap/water supply.
2. Release the water pressure in the supply hose.  
→ *Operating instructions, Page 11: Filter in the water inlet hose.*
3. Drain any residual detergent solution.  
→ *Operating instructions, Page 11: Drain pump.*
4. Disconnect the washing machine from the power supply.
5. Remove the hoses.

### 2. Installing transport bolts:

1. Remove the covers.
2. Insert all 4 spacers. Clamp the power cord into the holders. Insert and tighten the screws.

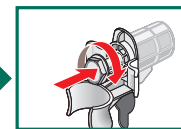
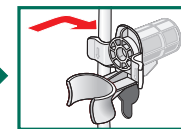
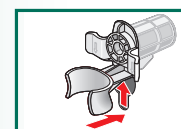

The transport bolts **must** be removed after transportation. → Page 3.



To prevent unused detergent from flowing into the outlet during the next wash: Pour 1 litre of water into dispenser II and start the **Drain** or **Spin** programme.

## Technical specifications

|  |  |
|--|--|
| ● <b>Dimensions (width x depth x height)</b> | WS, WLO and WLM: 60 x 45 x 85 cm<br>WM, WAP and WAS: 60 x 59 x 85 cm             |
| ● <b>Weight</b>                              | WS, WLO and WLM: 64 kg<br>WM, WAP and WAS: 77 kg                                 |
| ● <b>Power supply</b>                        | Nominal voltage 220-240 V, 50 Hz<br>Nominal current 10 A<br>Nominal power 2300 W |
| ● <b>Water pressure</b>                      | 100-1000 kPa (1-10 bar)  |
| ● <b>Test programmes</b>                     | Compliant with currently valid European Standard 60456                           |

6

## Aqua-Stop warranty *for appliances with Aqua-Stop only*

In addition to warranty claims against the seller based on the contract of sale and in addition to our appliance warranty, we shall pay damages under the following conditions:

1. If water damage was caused by a fault in our Aqua-Stop system, we shall compensate private users for damage.
2. The liability warranty applies to the service life of the appliance.
3. A claim can only be made under the warranty if the appliance and Aqua-Stop have been correctly installed and connected according to our instructions; this also includes a correctly installed Aqua-Stop extension (genuine accessory). Our warranty does not extend to defective supply lines or fittings up to the Aqua-Stop connection on the tap.
4. Appliances which feature Aqua-Stop can be left unattended during operation and it is not necessary to turn off the tap afterwards. The tap should only be turned off if you are away for a prolonged period, e.g. several weeks holiday.

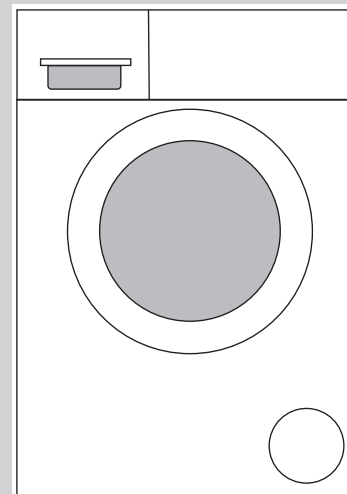

**Washing  
machine**

en

**Installation instructions**

## Contents

|  | <i>Page</i> |
|--|-------------|
| ■ Safety instructions . . . . .                  | 1           |
| ■ Environmentally-friendly disposal . . . . .    | 1           |
| ■ Scope of delivery . . . . .                    | 1           |
| ■ Installation area . . . . .                    | 2           |
| ■ Hose and cable lengths . . . . .               | 2           |
| ■ Built-under/built-in appliances . . . . .      | 2           |
| ■ Removing the transport bolts . . . . .         | 3           |
| ■ Water connection . . . . .                     | 4           |
| ■ Alignment . . . . .                            | 5           |
| ■ Electrical connection . . . . .                | 5           |
| ■ Transportation, e.g. if moving house . . . . . | 6           |
| ■ Technical specifications . . . . .             | 6           |
| ■ Aqua-Stop warranty . . . . .                   | 7           |



**Read these instructions before switching on the washing machine.  
Also follow the separate Operating instructions.  
Retain all documents for subsequent use or for the next owner.**