

Your new dryer

Congratulations! - You have chosen a modern, high-quality domestic appliance from Siemens.

The condensation dryer with heat exchanger and automatic cleaning function is outstanding in terms of efficient energy consumption and low maintenance requirements. → Page 6.

Every dryer which leaves our factory is carefully checked to ensure that it functions correctly and is in perfect condition.

Should you have any questions, our after-sales service will be pleased to help.

Environmentally responsible disposal

Dispose of packaging in an environmentally-responsible manner. This appliance is designated according to European directive 2002/96/EC which governs waste electrical and electronic equipment (WEEE). The directive provides an EU-wide framework for the return and recycling of used appliances.

For further information about our products, accessories, spare parts and services, please visit: www.siemens-home.com

Contents

	Page
Preparation	2
Setting the programmes	2
Drying	3/4
Notes on laundry	5
Important information	6
Overview of programmes	7
Installation	8
Frost protection / Transport	8
Cleaning and care	9
Technical data	10
Optional accessories	10
Normal noises	11
What to do if... / After-sales service	12
Safety instructions	13

Intended use

- only for domestic use.
- only to be used for drying fabrics that have been washed with water.

Do not leave children unsupervised near the dryer. Keep pets away from the dryer.

Preparing for installation, see Page 8

Never operate the dryer if it is damaged. Inform your after-sales service.

Only if your hands are dry. Only hold the plug by the plug casing.

Inspecting the dryer

Remove all objects from pockets. Pay particular attention to cigarette lighters. The drum must be empty before filling. See programme overview on page 7. See also separate instructions for "basket for woollens" (depending on the model)

Connecting the mains plug

Remove all objects from pockets. Pay particular attention to cigarette lighters. The drum must be empty before filling. See programme overview on page 7. See also separate instructions for "basket for woollens" (depending on the model)

Sorting and loading laundry

Remove all objects from pockets. Pay particular attention to cigarette lighters. The drum must be empty before filling. See programme overview on page 7. See also separate instructions for "basket for woollens" (depending on the model)

Selecting and adjusting the programme

Select the drying programme ... and adapt to individual requirements

Press the Start/Stop button

Emptying condensation

Empty the container after each drying cycle, not during drying!

- Remove the condensation container and hold it level.
- Pour out the condensation.
- Always push the container fully back in until it locks in place. If the **Container** indicator lamp is flashing → page 9.

Cleaning the fluff filter

The fluff filter consists of two parts.

- Open the door. Remove any fluff from the door/around the door.
- Pull out the inner fluff filter and fold it open.
- Remove any fluff (rub your hand over the fluff filter). If the fluff filter is very dirty or clogged, rinse it under running water and dry thoroughly.

Switching off the dryer

Turn the programme selector to **Off**. Do not leave laundry in the dryer.

Removing the laundry

Your dryer has an automatic Knitterschutz (Anti-Crease) function. The drum is moved at set intervals for 30 minutes after the programme has ended. Laundry remains loose and fluffy (for 60 minutes, if additional **Less Ironing** function is selected).

The programme has ended

when → lights up in the display panel.

Interrupt programme

removing or adding laundry.

The drying cycle can be interrupted for a brief period so that laundry may be added or removed. The selected programme must then be continued until it is finished.

Never switch the dryer off before the drying process has ended.

- Open the door. The drying cycle is interrupted.
- Remove or add laundry and close the door.
- If required, select a new programme and additional functions.
- Press the **Start/Stop** button. The remaining time is updated after a few minutes

Do not pull out/empty the condensation container when drying is in progress

Drying

Do not pull out/empty the condensation container when drying is in progress

Do not pull out/empty the condensation container when drying is in progress

Do not pull out/empty the condensation container when drying is in progress

Do not pull out/empty the condensation container when drying is in progress

Do not pull out/empty the condensation container when drying is in progress

Do not pull out/empty the condensation container when drying is in progress

Do not pull out/empty the condensation container when drying is in progress

Do not pull out/empty the condensation container when drying is in progress

Do not pull out/empty the condensation container when drying is in progress

Do not pull out/empty the condensation container when drying is in progress

Do not pull out/empty the condensation container when drying is in progress

Do not pull out/empty the condensation container when drying is in progress

Do not pull out/empty the condensation container when drying is in progress

Do not pull out/empty the condensation container when drying is in progress

Do not pull out/empty the condensation container when drying is in progress

Do not pull out/empty the condensation container when drying is in progress

Do not pull out/empty the condensation container when drying is in progress

Do not pull out/empty the condensation container when drying is in progress

Do not pull out/empty the condensation container when drying is in progress

Do not pull out/empty the condensation container when drying is in progress

Do not pull out/empty the condensation container when drying is in progress

Information on laundry ...

Follow the manufacturer's care information.

- Drying at normal temperature.
- Drying at low temperature → also select °C ↓ **Low Heat**.
- Do not machine dry.

Always observe the safety instructions on page 13!

Do not tumble-dry the following fabrics for example:

- Airtight fabrics (e.g. rubber-coated fabrics).
- Delicate materials (silk, curtains made from synthetic material) → they may crease.
- Oil-stained laundry.

Drying tips

- To ensure a consistent result, sort the laundry by fabric type and drying programme.
- Always dry very small fabrics (e.g. baby socks) together with large items of laundry (e.g. hand towels).
- Close zips, hooks and eyes, and do up any buttons. Tie belts, apron strings etc. together.
- Do not overdry easy-care laundry → risk of creasing. Allow laundry to finish drying in the air.
- Do not dry woollens in the dryer. They may, however, be refreshed → page 7 **Woollens Finish** programme (depending on the model).
- Do not iron laundry immediately after drying, fold items up and leave for a while → the remaining moisture will then be distributed evenly.
- Knitted fabrics (e.g. T-shirts, jerseys) often shrink slightly the first time they are tumble-dried. → Do not select the **Extra Dry** programme.
- Starched laundry is not always suitable for dryers → starch leaves behind a coating that adversely affects the drying operation.
- When washing laundry that is to be tumble-dried afterwards, use the correct amount of fabric softener according to the manufacturer's instructions.
- Use the Zeitprogramm (Timed programme) for small loads → this improves the drying result.

Environmental protection/energy-saving tips

- Before drying, spin the laundry thoroughly in the washing machine → the higher the spin speed, the shorter the drying time will be, thus consuming less energy. Also spin easy-care laundry.
- Use the maximum recommended capacity, but do not exceed it → "Programme overview", Page 7.
- Ensure the room is well ventilated during drying.
- Do not cover or seal the air inlet.

Important Information

Your dryer is designed to be particularly energy-saving and its technical features include a refrigeration circuit that uses energy efficiently, in a similar way to a refrigerator. The dryer's heat exchanger is cleaned automatically during drying. The fluff filters and filter in the condensation tank must be cleaned regularly.

Never operate the dryer without the fluff filter and condensation tank!

Fluff filter

During drying, fluff and hairs from the laundry are trapped in the fluff filter. A blocked fluff filter may impair the heat exchange process. The fluff filter should therefore be cleaned after every drying cycle. Rinse the filter regularly under running water → Page 4.

Filter in the condensation tank

The filter in the condensation tank cleans the condensation. This condensation is required for the automatic cleaning process. The filter must be cleaned regularly under running water. Empty the condensation tank before cleaning the filter → Page 9.

Fabrics

Do not dry any fabrics that have come into contact with solvents, oil, wax, grease or paint: e.g. hair styling products, nail varnish remover, stain remover, cleaning solvent. etc. Empty all pockets.

Do not dry airtight fabrics.

Avoid drying fabrics that produce a lot of fluff. Woollens should be refreshed only using the woollens programme.

Programme overview

After drying: laundry is to be ...

After drying: laundry is to be ...	max. 7 kg	max. 3.5 kg	max. 3 kg	max. 3 kg	max. 1.5 kg	max. 3 kg	max. 2 kg	max. 3 kg	max. 3 kg
Ironed	✓	✓	✓	✓	✓	✓	✓	✓	✓
lightly ironed dry	✓	✓	✓	✓	✓	✓	✓	✓	✓
not ironed	✓	✓	✓	✓	✓	✓	✓	✓	✓
passed through a mangle	✓	✓	✓	✓	✓	✓	✓	✓	✓
Cottons/Coloureds	✓	✓	✓	✓	✓	✓	✓	✓	✓
Iron Dry	✓	✓	✓	✓	✓	✓	✓	✓	✓
Cupboard Dry	✓	✓	✓	✓	✓	✓	✓	✓	✓
Cupboard Dry Plus	✓	✓	✓	✓	✓	✓	✓	✓	✓
Extra Dry	✓	✓	✓	✓	✓	✓	✓	✓	✓
Easy-Care	✓	✓	✓	✓	✓	✓	✓	✓	✓
Iron Dry	✓	✓	✓	✓	✓	✓	✓	✓	✓
Cupboard Dry	✓	✓	✓	✓	✓	✓	✓	✓	✓
Extra Dry	✓	✓	✓	✓	✓	✓	✓	✓	✓
Mixed Fabrics	✓	✓	✓	✓	✓	✓	✓	✓	✓
Cupboard Dry/Iron Dry	✓	✓	✓	✓	✓	✓	✓	✓	✓
Shirts/Blouses	✓	✓	✓	✓	✓	✓	✓	✓	✓
Outdoor	✓	✓	✓	✓	✓	✓	✓	✓	✓
Woollens Finish	✓	✓	✓	✓	✓	✓	✓	✓	✓
Rapid 40	✓	✓	✓	✓	✓	✓	✓	✓	✓
Programme time warm	✓	✓	✓	✓	✓	✓	✓	✓	✓
Programme time cold	✓	✓	✓	✓	✓	✓	✓	✓	✓

For cotton or linen fabrics that are still damp and easy-care fabrics. Creasing in fabrics is reduced. Fabrics are not dried completely. Hang up fabrics!

For fabrics with membrane coating, water-repellent fabrics, functional clothing, fleece fabrics (jackets/trousers) with removable internal lining (separately)

For woollen fabrics suitable for machine washing. Fabrics become fluffier, but not dry.

Remove fabrics once the programme has ended and allow to dry.

For laundry made of synthetic fibres, cotton or blended fabrics (for example that needs to be dried quickly). The values may differ from those specified depending on the type of fabric, mixture of laundry to be dried, residual moisture in the fabric and loading capacity.

For pre-dried, multi-layered, sensitive fabrics made of acrylic fibres, or separate small items of laundry. Also for subsequent drying.

For all types of fabrics. For freshening up or airing of items of laundry that have been worn for a short period of time.

0111 / 9000615800

Siemens Electrogeräte GmbH
Carl-Wery-Str. 34
81739 München/Germany

WT46W667GB

81739 München/Germany

81739 München/Germany

81739 München/Germany

81739 München/Germany

81739 München/Germany

81739 München/Germany

81739 München/Germany

81739 München/Germany

81739 München/Germany

81739 München/Germany

81739 München/Germany

81739 München/Germany

Installation

- Scope of delivery: dryer, installation and instruction manual, basket for woollens (depending on the model).
- Check dryer for transport damage.
- The dryer is very heavy. Do not lift without assistance.
- Be careful to avoid sharp edges.
- Do not install in a room which is susceptible to frost. Water may cause damage once it starts to freeze.
- If in doubt, have the appliance connected by a specialist.
- Do not lift the dryer by any of the protruding parts (e.g. the door) as they may break off.

1. Setting up the dryer

- The appliance plug must always be accessible.
- Ensure that the appliance is installed on a clean, level and firm surface.
- Do not obstruct the air inlet on the front of the dryer.
- Keep the area around the dryer clean.
- Level the dryer using the threaded feet.
- Use a spirit level.
- Do not remove the threaded feet under any circumstances.

- Do not install the dryer behind a door or sliding door, which could prevent or restrict opening of the dryer door. This will prevent children from locking themselves in and putting their lives in danger.

- Remove all accessories from the drum. The drum must be empty.

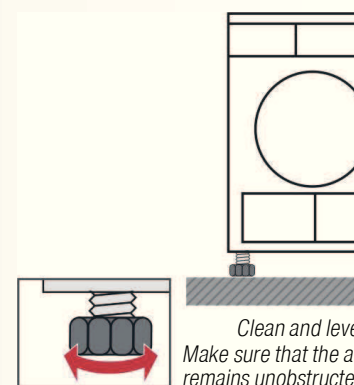

2. Mains connection see safety information → Page 13.

- Connect to an AC earthed socket. If in doubt, have the socket checked by a specialist.
- The mains voltage and the voltage shown on the rating plate (→ Page 10) must be the same.
- The connected load and necessary fuse protection are specified on the rating plate.

Frost protection

- Do not operate the dryer if there is a danger of frost.

Preparation

1. Empty the condensation container → page 4.
2. Select any programme using the programme selector.
3. Press the **Start/Stop** button → condensation is pumped into the container.
4. Wait 5 minutes and then empty the condensation container again.
5. Turn the programme selector to **Off**.

Transport

- Preparation of dryer → see Frost protection.
- Transport the dryer in a vertical upright position.
- Following transportation, leave the dryer to stand for two hours.

- There may be residual water in the dryer. This can leak out if the dryer is at an angle.

Care and cleaning

- Only when the appliance is switched off.

Heat exchanger

The heat exchanger of the dryer is cleaned automatically when drying is in progress. **CIn** appears in the display panel. Do not pull the condensation container out during the cleaning process.

Dryer housing, control panel, air intake

Wipe with a soft, damp cloth. Do not use harsh cleaning agents or solvents. Remove detergent and cleaning agent residue immediately. Some water may collect between the window and the seal during drying. This does not affect the proper operation of your dryer in any way.

Filter in the condensation tank

The filter is cleaned automatically when the condensation container is emptied. However, the filter should still be cleaned regularly under running water. This prevents stubborn deposits/dirt from building up. Cleaning is only required if the symbol flashes again in the display panel after the condensation container has been emptied.

1. Pull out the condensation container.

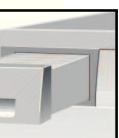

2. Pull the filter out of its snap-in lock.

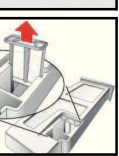

3. Clean the filter under running water or in the dishwasher.



4. Refit the filter.

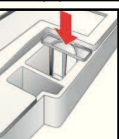

5. Insert the condensation tank so that it locks into place.

- Only operate the dryer with the filter inserted.

Moisture sensor

The dryer is equipped with stainless-steel moisture sensors. These measure how damp the laundry is. After long periods of use, a fine layer of limescale can form on the moisture sensors.

1. Open the door.
2. Clean the moisture sensors using a damp sponge with a rough surface.

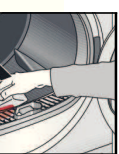

- Do not use steel wool or other abrasive materials.

Technical data

● Dimensions (DxWxH)	60 x 60 x 85 cm (adjustable height)
Weight	approximately 53 kg
Max. capacity	7 kg
Condensation container	4.0 l
Connection voltage	220-240 V
Connected load	max. 1000 W
Fuse protection	10 A
Ambient temperature	5-35 °C
Product number	Inside of door
Production number	Inside of door

The rating plate can be found on the back of the dryer.

- These are guide values determined under standard conditions.

	Spin speed in rpm (residual moisture)	Drying time in min.**	Energy consumption in kWh**
Cottons/Coloureds 7 kg			
Cupboard Dry*	1400 (approx. 50 %)	112	1.35
	1000 (approx. 60 %)	131	1.60
	800 (approx. 70 %)	150	1.86
Iron Dry*	1400 (approx. 50 %)	80	0.96
	1000 (approx. 60 %)	99	1.22
	800 (approx. 70 %)	118	1.47
Easy-care 3.5 kg			
Cupboard Dry*	800 (approx. 40 %)	51	0.56
	600 (approx. 50 %)	63	0.70

*Test programme to DIN EN 61121
**The values may differ from those given, depending on overvoltage and undervoltage, the type of fabric, composition of the laundry to be dried, the residual moisture in the fabric and the size of the load.

- **Drum interior light (bulb E14, 25 W)**
The drum is illuminated after the door is opened or closed, and after the programme has started. The light goes out automatically. To change the bulb → page 12.

Optional accessories (order from the after-sales service using the order number)

WZ 20460 Platform
For better loading and unloading. The basket contained in the drawer can be used to carry the laundry.

WZ 20310 Washer-dryer stack connection set
The dryer can be stacked on top of a suitable washing machine of the same depth and width, to save space. The dryer **must** be secured to the washing machine with this connection set.

WZ 20300
Same as WZ 20310, but with pull-out worktop.

WZ 20290 Installation underneath the worktop
Instead of the appliance covering plate, you **must** have a metal cover fitted by a specialist.

Normal noises

During drying, the compressor and the pump generate some noise which is entirely normal.

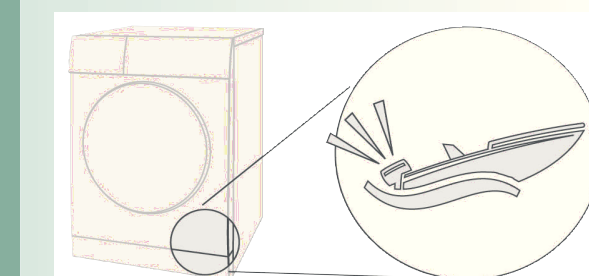

The compressor in the dryer may occasionally generate a droning noise.

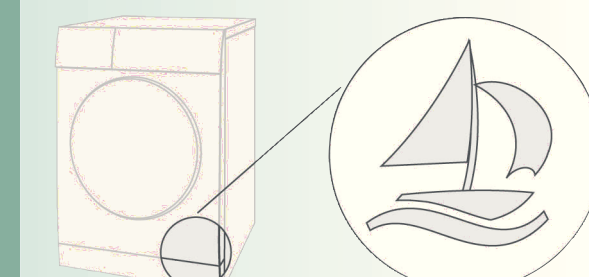

The compressor in the dryer is ventilated from time to time, which creates a whirring sound.

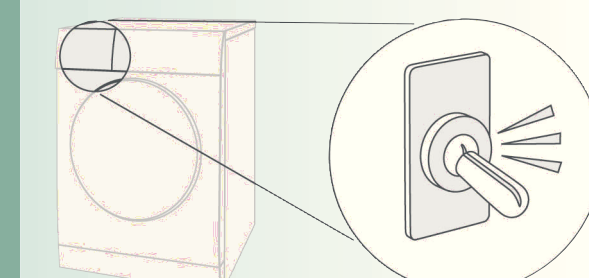

The automatic cleaning process causes a clicking noise.

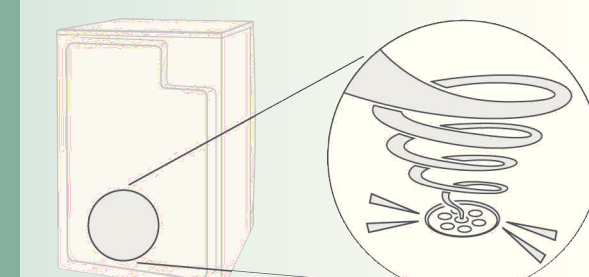

The process of pumping the condensation into the condensation container generates pumping noises.

What to do if ...

- If you cannot rectify a fault yourself, please contact our after-sales service. We will always find an appropriate solution and will avoid unnecessary visits by engineers. Trust the expertise of the manufacturer and rest assured that the repair will be carried out by trained service technicians using original spare parts. The contact details of your local after-sales service can be found in the enclosed **after-sales service** directory, or by calling one of these numbers:
 - **GB** 0844 8928999 (Calls from a BT landline will be charged at up to 3 pence per minute. A call set-up fee of up to 6 pence may apply.)
 - **IE** 01450 2655

- The **Start/Stop** indicator lamp does not light up. Mains plug plugged in? Programme selected?

- The symbol and **Start/Stop** indicator lamp flash. Empty container for condensation → see page 4. Clean the condensation container filter if necessary → Page 6. Each time the dryer is transported, you must wait two hours before operating it.

- The symbol and **Start/Stop** indicator lamp flash. Rinse the fluff filter under running water → Page 4.

- Dryer does not start. **Start/Stop** button selected? Door closed? Programme set? Ambient temperature greater than 5 °C?

- Water is leaking out. Make sure the dryer is level.

- The door opens by itself. Push the door closed until you hear it click into place.

- Drying result was not achieved (laundry too damp). Hot laundry feels damper than it actually is. The selected programme does not suit the load. Use another drying programme or, in addition, select the time programme → page 7.

- Use fine adjustment for the drying result → page 1/2. Fine layer of limescale on the humidity sensors → Clean the humidity sensors → page 9.

- Programme cancellation, e.g. tank full, mains power supply failure, door open or maximum drying time reached.

- Drying time too long. Clean the fluff filter under running water → page 4. Insufficient supply of air → ensure that air can circulate. Air inlet possibly blocked → Clear inlet → page 8. Ambient temperature higher than 35 °C → Ventilate the room.

- The humidity in the room increases significantly. Make sure the room is sufficiently ventilated.

- **CIn** appears in the display panel. Not an error! Automatic cleaning of the heat exchanger. Do not empty the condensation container.

- Power cut. Remove the laundry from the dryer immediately and spread it out. Heat may escape.

- The interior light is not working. Unplug the appliance plug, fold back the cover cap on the inside above the door (using a Torx 20 screwdriver) and replace the bulb. Close the cover cap. Never operate the dryer without a cover cap.

- Other intermittent noises and vibrations. Not an error! Normal noises → Page 11.

- Loud humming noise for several seconds. Has the condensation container been properly reinserted? → Push the condensation tank all the way in. Not an error! Normal noises → Page 11.

Safety instructions

- **Emergency ONLY use the dryer...**
 - Pull the appliance plug out of the socket immediately or disconnect the fuse.
 - In rooms inside the house.
 - To dry fabrics.

- **The dryer must NEVER...**
 - Be used for purposes other than those described above.
 - Be modified in terms of its technology or properties.

- **Hazards**
 - The dryer must not be used by children or persons who have not been instructed in its use.
 - Do not leave children unsupervised near the dryer.
 - Keep pets away from the dryer.
 - Remove all objects from the pockets of garments. Pay particular attention to cigarette lighters → **Risk of explosion**
 - Do not lean or sit on the door → **Risk of tipping**.

- **Installation**
 - Secure loose cables → **Tripping hazard**.
 - Do not operate the dryer where there is a risk of frost.
 - Connect the dryer according to specifications to an AC earthed socket, otherwise it cannot be guaranteed that the appliance is completely safe.
 - The cable cross-section must be sufficient.
 - Only use earth-leakage circuit breakers with the following symbol:
 - The appliance plug and socket must be compatible.
 - Do not use multiple plugs/connectors and/or extension cables.
 - Do not touch or hold the appliance plug with wet hands → **Risk of electric shock**.
 - Never pull the appliance plug out of the socket by its cable.
 - Do not damage the mains lead → **Risk of electric shock**.

- **Mains connection**
 - Only laundry must be loaded into the drum. Before switching on the dryer - check the contents.
 - Do not use the dryer if the laundry has been in contact with solvents, oil, wax, grease or paint (e.g. hair setting spray, nail polish remover, stain remover, cleaning solvent, etc.) → **Fire/explosion hazard**.
 - Hazard caused by dust (e.g. coal dust, flour): do not use the dryer → **Risk of explosion!**
 - Do not put laundry containing foamed material/rubber in the dryer → elastic material may be destroyed and the dryer may be damaged due to possible deformation of the foamed material.
 - Switch off the dryer once the programme has ended.
 - The water from condensation is not drinking water and may be contaminated with fluff.

- **Operation**
 - Do not use the dryer if it is defective or if you suspect that it is. Repairs must only be carried out by the after-sales service.
 - Do not use a dryer with a faulty mains lead. To prevent risks, a faulty mains lead must only be replaced by the after-sales service.
 - Before changing the bulb of the interior light make absolutely sure you have pulled the appliance plug from the socket → **Risk of electric shock!**
 - Only use genuine spare parts and accessories for safety reasons.

- **Defect**
 - Dryer: unplug the appliance plug, then cut the mains lead from the appliance. Dispose of the dryer at an approved public disposal facility.
 - The heat exchanger contains fluorinated greenhouse gas R-407C covered by the Kyoto Protocol → dispose of in a proper manner. Capacity: 0.43 kg.
 - Packaging: keep all packaging out of reach of babies and children. → **Danger of suffocation!**
 - All materials are environmentally safe and recyclable. Dispose of in an environmentally-responsible manner.

- **Spare parts**
 - Only use genuine spare parts and accessories for safety reasons.

- **Disposal**
 - Dryer: unplug the appliance plug, then cut the mains lead from the appliance. Dispose of the dryer at an approved public disposal facility.
 - The heat exchanger contains fluorinated greenhouse gas R-407C covered by the Kyoto Protocol → dispose of in a proper manner. Capacity: 0.43 kg.
 - Packaging: keep all packaging out of reach of babies and children. → **Danger of suffocation!**
 - All materials are environmentally safe and recyclable. Dispose of in an environmentally-responsible manner.

- Observe the safety instructions on page 13.



Tumble dryer

Operating and installation instructions

- Read these instructions before switching on the dryer.

en

SIEMENS

Your new dryer

Congratulations! - You have chosen a modern, high-quality domestic appliance from Siemens.

The condensation dryer with heat exchanger and automatic cleaning function is outstanding in terms of efficient energy consumption and low maintenance requirements. → Page 6.

Every dryer which leaves our factory is carefully checked to ensure that it functions correctly and is in perfect condition.

Should you have any questions, our after-sales service will be pleased to help.

Environmentally responsible disposal

Dispose of packaging in an environmentally-responsible manner.

This appliance is designated according to European directive

2002/96/EC which governs waste electrical and electronic equipment (WEEE).

The directive provides an EU-wide framework for the return and recycling of used appliances.

For further information about our products, accessories, spare parts and services, please visit: www.siemens-home.com

Contents

	Page
Preparation	2
Setting the programmes	2
Drying	3/4
Notes on laundry	5
Important Information	6
Overview of programmes	7
Installation	8
Frost protection / Transport	8
Cleaning and care	9
Technical data	10
Optional accessories	10
Normal noises	11
What to do if... / After-sales service	12
Safety instructions	13

Intended use

- only for domestic use.
- only to be used for drying fabrics that have been washed with water.



Do not leave children unsupervised near the dryer.
Keep pets away from the dryer.

Preparing for installation, see Page 8



Never operate the dryer if it is damaged.
Inform your after-sales service.



Only if your hands are dry.
Only hold the plug by the plug casing.

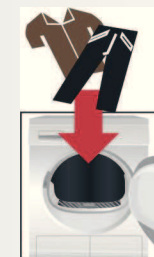

Sorting and loading

Remove all objects from pockets.
Pay particular attention to cigarette lighters.
The drum must be empty before filling.

See programme overview on page 7.
See also separate instructions for "basket for wool" (depending on the model)

Selecting and adjusting the programmes

Select the programme

... and adapt to individual requirements

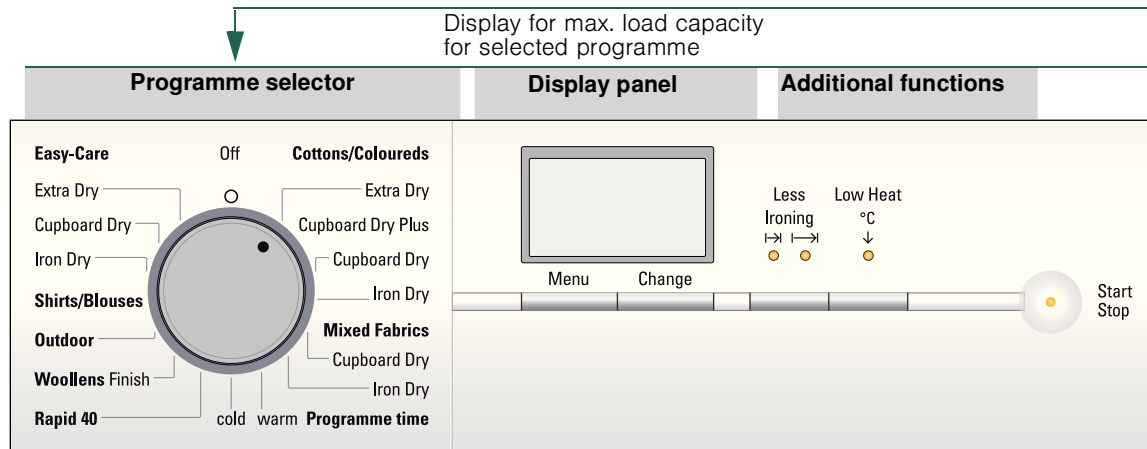

All buttons are sensitive. Be touched lightly.

Press the button



Only use the dryer if the door is closed and the drum is inserted!

		For selecting the settings.	Menu	°C ↓ Low Heat	Reduced temperature for delicate fabrics or for shorter drying time; e.g. acrylic, polyamide, elastane or silk.
		To change all settings in the display panel.	Change	→←→ Less Ironing	Reduces creasing and prolongs the anti-creasing programme has finished; can be selected for all programmes.
1 -24 hrs	End of the programme after ... (depending on the programme selected, e.g. 1:54h → 2h, you can always select up to the next full hour).		Electronic start timer	Status indicators	Programme sequence displays: drying, iron dry, cupboard dry, slackening
0, 1, 2, 3, 4	Signal volume selectable in four stages: 0 (off), 1 (quiet), 2 (normal), 3 (loud), 4 (very loud).		Signal	Service indicators	
On-Off	Provides protection against unintentional changes to the functions set (press and hold the Menu button for 5 seconds).		Appliance lock	Fluff filter	Rinse the fluff filter under running water – Empty the condensation container.
0, 1, 2, 3	The drying result (e.g. cupboard dry) can be increased in three stages (1 - 3) for the programmes Cottons/Coloureds , Easy-Care , Mixed Fabrics and Rapid 40 → presetting = 0. After one of these programmes has been finely adjusted, the setting is retained for the others.		Fine adjustment Drying result	Container	If necessary, clean the filter in the condensation container.
600-1800 6	The spin speed that was used in the washing machine, for more precise indication of the projected drying duration only.		Spin speed		

Drying



1
2
3

Drying

Do not pull out/empty the condensation container when drying is in progress

Emptying condensation

Empty the container **after each** drying cycle, not during drying!

1. Remove the condensation container and hold it level.
 2. Pour out the condensation.
 3. Always push the container fully back in until it locks in place.
- If the **Container** indicator lamp is flashing → page 9.

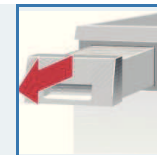

Cleaning the fluff filter

The fluff filter consists of two parts.

Clean the inner fluff filter **after every** drying cycle:

1. Open the door. Remove any fluff from the door/around the door.
2. Pull out the inner fluff filter and fold it open.
3. Remove any fluff (rub your hand over the fluff filter).
If the fluff filter is very dirty or clogged, rinse it under running water and dry thoroughly.

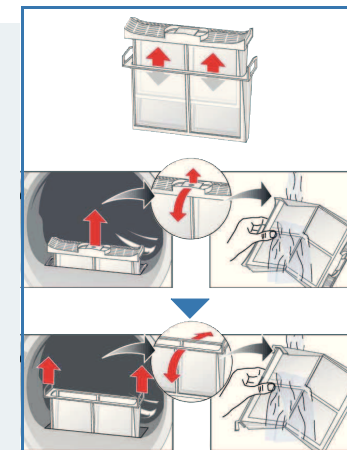

Clean the outer fluff filter **after every 5th** drying cycle:

4. Remove the outer fluff filter.
5. Open it and remove any fluff.
Rinse under running water and dry thoroughly.
6. Fold the fluff filters closed, put them back together and reinsert into the appliance.

Switching off the dryer

Turn the programme selector to **Off**.
Do not leave laundry in the dryer.

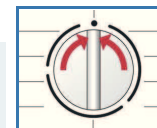

Removing the laundry

Your dryer has an automatic Knitterschutz (Anti-Crease) function. The drum is moved at set intervals for 30 minutes after the programme has ended. Laundry remains loose and fluffy (for 60 minutes, if additional **Less Ironing** function is selected).

The programme has ended when lights up in the display panel.

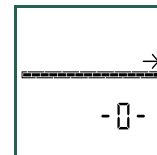

Interrupt programme removing or adding laundry.

The drying cycle can be interrupted for a brief period so that laundry may be added or removed. The selected programme must then be continued until it is finished.

Never switch the dryer off before the drying process has ended.

1. Open the door. The drying cycle is interrupted.
2. Remove or add laundry and close the door.
3. If required, select a new programme and additional functions.
4. Press the **Start/Stop** button. The remaining time is updated after a few minutes.

Information on laundry ...



Labelling of fabrics

Follow the manufacturer's care information.

- Drying at normal temperature.
- Drying at low temperature → also select °C ↓ **Low Heat**.
- Do not machine dry.



Always observe the safety instructions on page 13!

Do not tumble-dry the following fabrics for example:

- Airtight fabrics (e.g. rubber-coated fabrics).
- Delicate materials (silk, curtains made from synthetic material) → they may crease.
- Oil-stained laundry.



Drying tips

- To ensure a consistent result, sort the laundry by fabric type and drying programme.
- Always dry very small fabrics (e.g. baby socks) together with large items of laundry (e.g. hand towels).
- Close zips, hooks and eyes, and do up any buttons. Tie belts, apron strings etc. together.
- Do not overdry easy-care laundry → risk of creasing. Allow laundry to finish drying in the air.
- Do not dry woollens in the dryer. They may, however, be refreshed → *page 7 Woollens Finish* programme (*depending on the model*).
- Do not iron laundry immediately after drying, fold items up and leave for a while → the remaining moisture will then be distributed evenly.
- Knitted fabrics (e.g. T-shirts, jerseys) often shrink slightly the first time they are tumble-dried. → Do not select the **Extra Dry** programme.
- Starched laundry is not always suitable for dryers → starch leaves behind a coating that adversely affects the drying operation.
- When washing laundry that is to be tumble-dried afterwards, use the correct amount of fabric softener according to the manufacturer's instructions.
- Use the Zeitprogramm (Timed programme) for small loads → this improves the drying result.

Environmental protection/energy-saving tips

- Before drying, spin the laundry thoroughly in the washing machine → the higher the spin speed, the shorter the drying time will be, thus consuming less energy. Also spin easy-care laundry.
- Use the maximum recommended capacity, but do not exceed it → "Programme overview", *Page 7*.
- Ensure the room is well ventilated during drying.
- Do not cover or seal the air inlet.

Important Information

Your dryer is designed to be particularly energy-saving and its technical features include a refrigeration circuit that uses energy efficiently, in a similar way to a refrigerator. The dryer's heat exchanger is cleaned automatically during drying. The fluff filters and filter in the condensation tank must be cleaned regularly.



Never operate the dryer without the fluff filter and condensation tank!

Fluff filter

During drying, fluff and hairs from the laundry are trapped in the fluff filter. A blocked fluff filter may impair the heat exchange process.

The fluff filter should therefore be cleaned after every drying cycle.

Rinse the filter regularly under running water → *Page 4*.

Filter in the condensation tank

The filter in the condensation tank cleans the condensation. This condensation is required for the automatic cleaning process. The filter must be cleaned regularly under running water. Empty the condensation tank before cleaning the filter → *Page 9*.

Fabrics

Do not dry any fabrics that have come into contact with solvents, oil, wax, grease or paint: e.g. hair styling products, nail varnish remover, stain remover, cleaning solvent. etc. Empty all pockets.

Do not dry airtight fabrics.

Avoid drying fabrics that produce a lot of fluff.

Woollens should be refreshed only using the woollens programme.

Programme overview

see also page 5



After drying: laundry is to be ...		T-shirt	Shirts	Trousers	Skirts/dresses	Sportswear	Work clothing	Anoraks	Towelling gowns	Underwear	Socks	Bed linen	Table linen	Terry towels	Tea towels/ towels
Ironed	Lightly ironed dry	✓	✓	✓	✓	✓	✓			✓	✓	✓	✓	✓	✓
Not ironed	Passed through a mangle	✓	✓												
Cottons/Coloureds max. 7 kg		For whites and colours/cotton or linen.													
Iron Dry		✓	✓	✓	✓	✓	✓			✓	✓	✓	✓	✓	✓
Cupboard Dry		✓	✓								✓	✓	✓	✓	✓
Cupboard Dry Plus											✓	✓	✓	✓	✓
Extra Dry									✓			✓	✓	✓	✓
Easy-Care max. 3.5 kg		For non-iron laundry made of synthetic fibres and blended fabric, cotton.													
Iron Dry		✓	✓	✓	✓	✓	✓			✓	✓	✓			
Cupboard Dry		✓	✓								✓	✓			
Extra Dry		✓	✓								✓	✓			
Mixed Fabrics max. 3 kg		For mixed items of laundry made of cotton and easy-care fabrics.													
Cupboard Dry/Iron Dry		For cotton or linen fabrics that are still damp and easy-care fabrics. Creasing in fabrics is reduced. Fabrics are not dried completely. Hang up fabrics!													
Shirts/Blouses max. 3 kg		For fabrics with membrane coating, water-repellent fabrics; functional clothing, fleece fabrics (dry jackets/trousers with removable internal lining separately).													
Outdoor max. 1.5 kg		For woollen fabrics suitable for machine-washing. Fabrics become fluffier but not dry.													
Woollens Finish max. 3 kg		Remove fabrics once the programme has ended and allow to dry.													
Rapid 40 max. 2 kg		For laundry made of synthetic fibres, cotton or blended fabrics (for example) that needs to be dried quickly. The values may differ from the those specified depending on the type of fabric, mixture of laundry to be dried, residual moisture in the fabric and loading capacity.													
Programme time warm max. 3 kg		For pre-dried, multi-layered, sensitive fabrics made of acrylic fibres, or separate small items of laundry. Also for subsequent drying.													
Programme time cold max. 3 kg		For all types of fabrics. For freshening up or airing of items of laundry that have been worn for a short period of time.													

0111 / 9000615800



Siemens Electrogeräte GmbH
Carl-Wery-Str. 34
81739 München/Germany

WT46W567GB

Installation

- ! – Scope of delivery: dryer, installation and instruction manual, basket for woollens (depending on the model).
- Check dryer for transport damage.
- The dryer is very heavy. Do not lift without assistance.
- Be careful to avoid sharp edges.
- Do not install in a room which is susceptible to frost. Water may cause damage once it starts to freeze.
- If in doubt, have the appliance connected by a specialist.
- Do not lift the dryer by any of the protruding parts (e.g. the door) as they may break off.

1. Setting up the dryer

- The appliance plug must always be accessible.
- Ensure that the appliance is installed on a clean, level and firm surface.
- Do not obstruct the air inlet on the front of the dryer.
- Keep the area around the dryer clean.
- Level the dryer using the threaded feet. Use a spirit level.
- Do not remove the threaded feet under any circumstances.

! Remove all accessories from the drum. The drum must be empty.

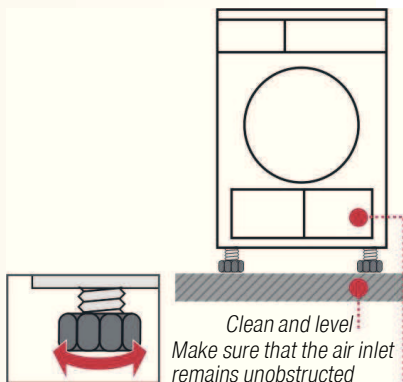

- ! Do not install the dryer behind a door or sliding door, which could prevent or restrict opening of the dryer door. This will prevent children from locking themselves in and putting their lives in danger.

2. Mains connection see safety information → Page 13.

- Connect to an AC earthed socket. If in doubt, have the socket checked by a specialist.
- The mains voltage and the voltage shown on the rating plate (→ Page 10) must be the same.
- The connected load and necessary fuse protection are specified on the rating plate.

Frost protection

! Do not operate the dryer if there is a danger of frost.

Preparation

1. Empty the condensation container → page 4.
2. Select any programme using the programme selector.
3. Press the **Start/Stop** button → condensation is pumped into the container.
4. Wait 5 minutes and then empty the condensation container again.
5. Turn the programme selector to **Off**.

Transport

- Preparation of dryer → see Frost protection.
- Transport the dryer in a vertical upright position.
- Following transportation, leave the dryer to stand for two hours.

i There may be residual water in the dryer. This can leak out if the dryer is at an angle.

Care and cleaning

! Only when the appliance is switched off.

i Heat exchanger

The heat exchanger of the dryer is cleaned automatically when drying is in progress, **Cin** appears in the display panel. Do not pull the condensation container out during the cleaning process.

☞ Dryer housing, control panel, air intake

☞ Wipe with a soft, damp cloth. Do not use harsh cleaning agents or solvents. Remove detergent and cleaning agent residue immediately. Some water may collect between the window and the seal during drying. This does not affect the proper operation of your dryer in any way.

☞ Filter in the condensation tank

☞ The filter is cleaned automatically when the condensation container is emptied. However, the filter should still be cleaned regularly under running water. This prevents stubborn deposits/dirt from building up. Cleaning is only required if the symbol  flashes again in the display panel after the condensation container has been emptied.

1. Pull out the condensation container.

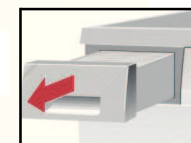

2. Pull the filter out of its snap-in lock.

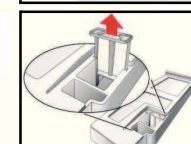

3. Clean the filter under running water or in the dishwasher.



4. Refit the filter.

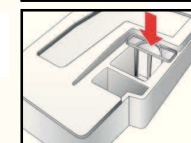

5. Insert the condensation tank so that it locks into place.

! Only operate the dryer with the filter inserted.

☞ Moisture sensor

☞ The dryer is equipped with stainless-steel moisture sensors. These measure how damp the laundry is. After long periods of use, a fine layer of limescale can form on the moisture sensors.

1. Open the door.
2. Clean the moisture sensors using a damp sponge with a rough surface.

! Do not use steel wool or other abrasive materials.



Technical data

● Dimensions (DxWxH)	60 x 60 x 85 cm (adjustable height)
Weight	approximately 53 kg
Max. capacity	7 kg
Condensation container	4.0 l
Connection voltage	220-240 V
Connected load	max. 1000 W
Fuse protection	10 A
Ambient temperature	5 - 35 °C
Product number	Inside of door
Production number	

The rating plate can be found on the back of the dryer.

- **Consumption rates** These are guide values determined under standard conditions.

	Spin speed in rpm (residual moisture)	Drying time in min.**	Energy consumption in kWh**
Cottons/Coloureds 7 kg			
Cupboard Dry*	1400 (approx. 50 %)	112	1.35
	1000 (approx. 60 %)	131	1.60
	800 (approx. 70 %)	150	1.86
Iron Dry*	1400 (approx. 50 %)	80	0.96
	1000 (approx. 60 %)	99	1.22
	800 (approx. 70 %)	118	1.47
Easy-care 3.5 kg			
Cupboard Dry*	800 (approx. 40 %)	51	0.56
	600 (approx. 50 %)	63	0.70

*Test programme to DIN EN 61121

**The values may differ from those given, depending on overvoltage and undervoltage, the type of fabric, composition of the laundry to be dried, the residual moisture in the fabric and the size of the load.

- **Drum interior light (bulb E14, 25 W)**

The drum is illuminated after the door is opened or closed, and after the programme has started. The light goes out automatically. To change the bulb → page 12.

Optional accessories (order from the after-sales service using the order number)

WZ 20460 **Platform**
For better loading and unloading. The basket contained in the drawer can be used to carry the laundry.

WZ 20310 **Washer-dryer stack connection set**
The dryer can be stacked on top of a suitable washing machine of the same depth and width, to save space. The dryer **must** be secured to the washing machine with this connection set.

WZ 20300
Same as WZ 20310, but with pull-out worktop.

WZ 20290 **Installation underneath the worktop**
Instead of the appliance covering plate, you **must** have a metal cover fitted by a specialist.

Normal noises

During drying, the compressor and the pump generate some noise which is entirely normal.

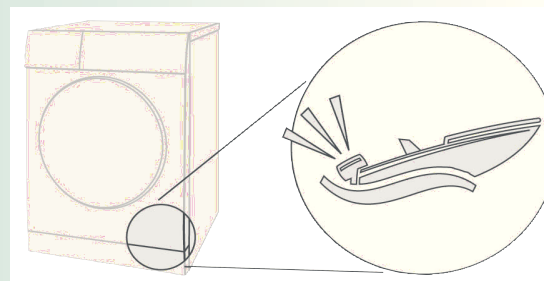

The compressor in the dryer may occasionally generate a droning noise.

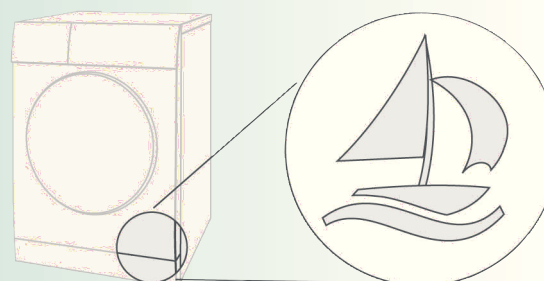

The compressor in the dryer is ventilated from time to time, which creates a whirring sound.

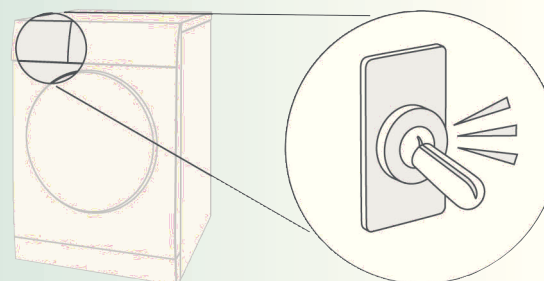

The automatic cleaning process causes a clicking noise.

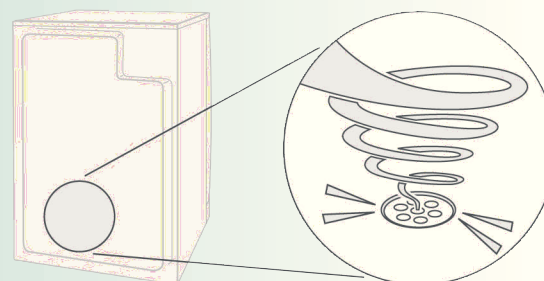

The process of pumping the condensation into the condensation container generates pumping noises.



What to do if ...



If you cannot rectify a fault yourself, please contact our after-sales service. We will always find an appropriate solution and will avoid unnecessary visits by engineers. Trust the expertise of the manufacturer and rest assured that the repair will be carried out by trained service technicians using original spare parts. The contact details of your local after-sales service can be found in the enclosed **after-sales service** directory, or by calling one of these numbers:

- **GB** 0844 8928999 (Calls from a BT landline will be charged at up to 3 pence per minute. A call set-up fee of up to 6 pence may apply.)
- **IE** 01450 2655

When contacting the after-sales service, please quote the appliance's product number (E no.) and production number (FD) (see the inside of the door).
Set the programme selector to **Off** and remove the appliance plug from the socket.

● The Start/Stop indicator lamp does not light up.	Mains plug plugged in? Programme selected?
● The  symbol and Start/Stop indicator lamp flash.	Empty container for condensation → see page 4. Clean the condensation container filter if necessary → Page 6. Each time the dryer is transported, you must wait two hours before operating it.
● The  symbol and Start/Stop indicator lamp flash.	Rinse the fluff filter under running water → Page 4.
● Dryer does not start.	Start/Stop button selected? Door closed? Programme set? Ambient temperature greater than 5 °C?
● Water is leaking out.	Make sure the dryer is level.
● The door opens by itself.	Push the door closed until you hear it click into place.
● Drying result was not achieved (laundry too damp).	Hot laundry feels damper than it actually is. The selected programme does not suit the load. Use another drying programme or, in addition, select the time programme → page 7. Use fine adjustment for the drying result → page 1/2. Fine layer of limescale on the humidity sensors → Clean the humidity sensors → page 9. Programme cancellation, e.g. tank full, mains power supply failure, door open or maximum drying time reached.
● Drying time too long.	Clean the fluff filter under running water → page 4. Insufficient supply of air → ensure that air can circulate. Air inlet possibly blocked → Clear inlet → page 8. Ambient temperature higher than 35 °C → Ventilate the room.
● The humidity in the room increases significantly.	Make sure the room is sufficiently ventilated.
● CIn appears in the display panel.	Not an error! Automatic cleaning of the heat exchanger. Do not empty the condensation container.
● Power cut.	Remove the laundry from the dryer immediately and spread it out. Heat may escape.
● The interior light is not working.	Unplug the appliance plug, fold back the cover cap on the inside above the door (using a Torx 20 screwdriver) and replace the bulb. Close the cover cap. Never operate the dryer without a cover cap.
● Other intermittent noises and vibrations.	Not an error! Normal noises → Page 11.
● Loud humming noise for several seconds.	Has the condensation container been properly reinserted? → Push the condensation tank all the way in. Not an error! Normal noises → Page 11.

Safety instructions



Emergency ONLY use the dryer...	– Pull the appliance plug out of the socket immediately or disconnect the fuse. – In rooms inside the house. – To dry fabrics.
The dryer must NEVER...	– Be used for purposes other than those described above. – Be modified in terms of its technology or properties.
Hazards	– The dryer must not be used by children or persons who have not been instructed in its use. – Do not leave children unsupervised near the dryer. – Keep pets away from the dryer. – Remove all objects from the pockets of garments. Pay particular attention to cigarette lighters → Risk of explosion – Do not lean or sit on the door → Risk of tipping.
Installation	– Secure loose cables → Tripping hazard. – Do not operate the dryer where there is a risk of frost.
Mains connection	– Connect the dryer according to specifications to an AC earthed socket, otherwise it cannot be guaranteed that the appliance is completely safe. – The cable cross-section must be sufficient. – Only use earth-leakage circuit breakers with the following symbol:  – The appliance plug and socket must be compatible. – Do not use multiple plugs/connectors and/or extension cables. – Do not touch or hold the appliance plug with wet hands → Risk of electric shock. – Never pull the appliance plug out of the socket by its cable. – Do not damage the mains lead → Risk of electric shock.
Operation	– Only laundry must be loaded into the drum. Before switching on the dryer - check the contents. – Do not use the dryer if the laundry has been in contact with solvents, oil, wax, grease or paint (e.g. hair setting spray, nail polish remover, stain remover, cleaning solvent, etc.) → Fire/explosion hazard. – Hazard caused by dust (e.g. coal dust, flour): do not use the dryer → Risk of explosion! – Do not put laundry containing foamed material/rubber in the dryer → elastic material may be destroyed and the dryer may be damaged due to possible deformation of the foamed material. – Switch off the dryer once the programme has ended. – The water from condensation is not drinking water and may be contaminated with fluff.
Defect	– Do not use the dryer if it is defective or if you suspect that it is. Repairs must only be carried out by the after-sales service. – Do not use a dryer with a faulty mains lead. To prevent risks, a faulty mains lead must only be replaced by the after-sales service. – Before changing the bulb of the interior light make absolutely sure you have pulled the appliance plug from the socket → Risk of electric shock!
Spare parts	– Only use genuine spare parts and accessories for safety reasons.
Disposal	– Dryer: unplug the appliance plug, then cut the mains lead from the appliance. Dispose of the dryer at an approved public disposal facility. – The heat exchanger contains fluorinated greenhouse gas R-407C covered by the Kyoto Protocol → dispose of in a proper manner. Capacity: 0.43 kg. – Packaging: keep all packaging out of reach of babies and children. → Danger of suffocation! – All materials are environmentally safe and recyclable. Dispose of in an environmentally-responsible manner.



Observe the safety instructions on page 13.



Tumble dryer

Operating and installation instructions

en



Read these instructions before switching on the dryer.

SIEMENS