



**BOSCH**  
Invented for life



EN Instruction manual

PI..75N14E

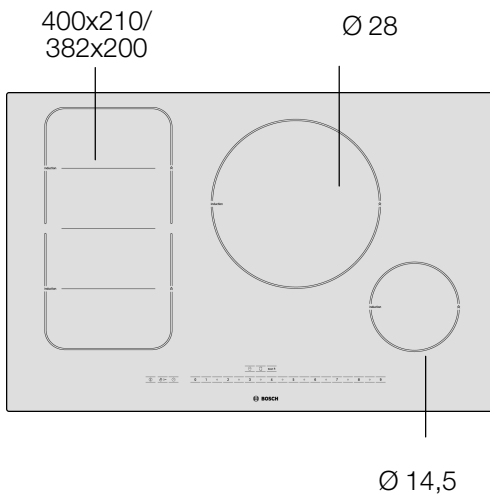
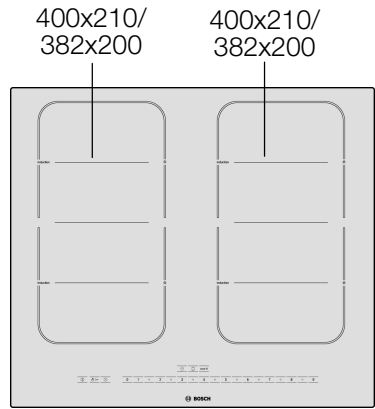
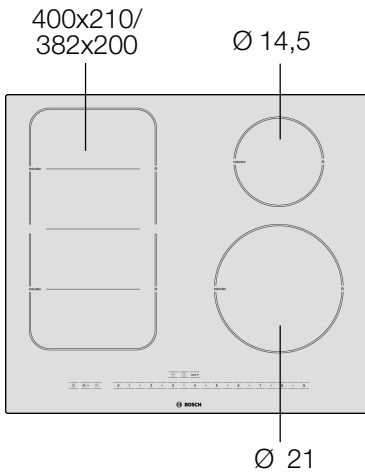

Ø = cm

# Table of contents

<b>Safety information</b> .....	<b>5</b>
Safety instructions .....	5
Causes of damage .....	8
<b>Environmental protection</b> .....	<b>9</b>
Environmentally-friendly disposal .....	9
Tips for saving energy .....	9
<b>Induction cooking</b> .....	<b>10</b>
Advantages of induction cooking .....	10
Suitable pans .....	10
<b>Getting to know your appliance</b> .....	<b>12</b>
The control panel .....	12
The hotplates .....	13
Residual heat warning light .....	13
<b>Programming the hob</b> .....	<b>14</b>
Switching the hob on and off .....	14
Adjusting the hotplate .....	14
Cooking table .....	15
<b>Flexible zone</b> .....	<b>18</b>
As one hotplate .....	18
As two hotplates .....	19
<b>Childproof lock</b> .....	<b>19</b>
Switching the childproof lock on and off .....	19
Switching the permanent childproof lock on and off .....	20
<b>The Powerboost Function</b> .....	<b>20</b>
How to activate it .....	21
How to deactivate it .....	21

# Table of contents

<b>Timer function</b> .....	<b>21</b>
Automatic hotplate switch-off .....	21
Kitchen timer .....	23
<b>Control panel pause</b> .....	<b>23</b>
<b>Automatic time limit</b> .....	<b>24</b>
<b>Basic settings</b> .....	<b>24</b>
Changing the basic settings .....	25
<b>Care and cleaning</b> .....	<b>26</b>
Cooking hob .....	26
Hob surround .....	27
<b>Fixing malfunctions</b> .....	<b>28</b>
Normal noises heard during appliance operation ..	29
<b>After-sales service</b> .....	<b>30</b>

---

# Safety information

**Read these instructions carefully.** Only after doing this will you be able to operate your appliance properly.

Keep the operating and assembly instructions in a safe place. If the appliance is given to another person, ensure the appliance documentation is also included.

Check the appliance after removing it from the packaging. If it has suffered any damage during transport, do not connect the appliance, contact the After-Sales Service and provide a written notification of the damage caused. If you do not, you will lose your right to any type of compensation.

---

## Safety instructions

This appliance is designed for domestic use only. Only use the cooking hob for food preparation. Never leave the appliance unattended during operation.

### Safe operation

To use this appliance safely, adults and children who, as a result of

- physical, sensory or mental disability
- or lack of experience or knowledge

are not capable of using this appliance should not do so without the supervision of a responsible adult.

Children must be supervised to ensure that they do not play with the appliance.

### Overheated oil, butter or margarine

Overheated oil or butter (margarine) can quickly ignite. It may cause a fire!

Ensure that you keep a constant watch when cooking foods with oil and butter. In the event that the oil or butter catches fire, never use water to put it out. Put the fire out quickly by covering the pan with a cover or dish.

Switch off the hotplate.

### **Cooking using a water bath**

Cooking using a water bath involves cooking food inside a pot which is in turn placed in another larger pan which contains water. In this way, the food is heated gently and constantly and it is the hot water, not the direct heat of the hotplate, which cooks the food.

When cooking food using a water bath, avoid resting tins, glass jars or containers made from other materials directly on the base of the pan which contains the water, to avoid breaking the glass in both the hob and the container as a result of the hotplate reheating.

### **Hot cooking hob**

Risk of burns! Do not touch the hot areas of the hob. It is imperative that children keep away from the appliance.

It may cause a fire! Never rest flammable objects on the cooking hob.

It may cause a fire! If there is a drawer below the cooking hob, this should not be used to store any flammable objects or sprays.

### **Wet hotplates and pan bases**

Risk of injuries! If there is any liquid between the base of the pan and the hotplate this could generate steam pressure. As a result, the pan could jump unexpectedly.

Always ensure that the hotplate and the base of the pan are kept dry.

### **Cracks in the hob**

Risk of electrocution! Disconnect the appliance from the mains if the cooking hob is broken or cracked.

Notify the After-Sales Service.

### **The hotplate heats up but the visual indication does not work**

Risk of burns! Disconnect the hotplate if the indicator does not work.

Notify the After-Sales Service.

### **The hob switches off automatically**

Risk of fire. If the hob switches itself off and can then no longer be used, it may unexpectedly switch itself on later. In order to prevent this, disconnect the hob from the power supply. To do so, switch off the circuit breaker in the fuse box. Call the after-sales service.

### **Do not place metal objects on the induction hob**

Risk of burns! Do not leave cutlery, lids or other metal objects on the hob as they can heat up very quickly.

### **Taking care of the cooling fan**

This hob is fitted with a fan in the lower section. Risk of malfunction! If a drawer is fitted beneath the hob you must not keep small objects or paper in it as, if they are picked up, they could damage the cooling fan or affect the cooling system.

Please note: There should be a minimum distance of 2 cm between the drawer contents and the cooling fan.

### **Incorrect repairs**

Risk of electric shock! Incorrect repairs can be dangerous. Switch off the circuit breaker in the fuse box, if the appliance is faulty. Call the after-sales service. Repairs may only be carried out, and damaged power cables replaced, by one of our experienced after-sales engineers.

### **Connection cable**

Any work on the appliance, including replacing or fitting the power cable must be carried out by the technical assistance service.

The connection cables of the electric appliances must not touch the hot areas of the hob. The cable insulation and hob can be damaged.



This appliance complies with current safety regulations and electromagnetic compatibility regulations.

Nevertheless, people with a **pacemaker** should not use this appliance. It is impossible to guarantee that all such devices found on the market comply with current safety regulations and electromagnetic compatibility regulations, and that dangerous interference will not occur. It is also possible that people with other types of device, such as a hearing aid, could experience some discomfort.

### **Switching the hob off**

Always switch the hob off using the main switch after each use. Do not wait until the hob switches off automatically when the pan is removed.

# Causes of damage

## Bases of pots and pans

Rough pot and pan bases scratch the ceramic.  
Avoid boiling pots dry. This may cause damage.

## Hot pots and pans

Never place hot pots or pans on the control panel, the display area or the surround.  
This may cause damage.

## Hard and pointed objects

Damage can occur if hard or pointed objects fall on the hob.

## Foil and plastic

Aluminium foil and plastic containers melt on hot hotplates. Oven protective foil is not suitable for your hob.

## Overview

The following table provides an overview of the most frequent kinds of damage:

Damage	Cause	Action
Stains	Food spills	Remove spills immediately with a glass scraper.
	Unsuitable cleaning agents	Use only cleaning agents which are suitable for ceramic.
Scratches	Salt, sugar and sand	Do not use the hob as a work surface or storage space.
	Rough pot and pan bases scratch the ceramic.	Check your cookware.
Discolouration	Unsuitable cleaning agents	Use only cleaning agents which are suitable for ceramic.
	Pan abrasion	Lift the pots and pans when moving them.
Blisters	Sugar, food with a high sugar content	Remove spills immediately with a glass scraper.



---

# Environmental protection

---

## Environmentally-friendly disposal



Unpack the appliance and dispose of the packaging in an environmentally-responsible manner.

This appliance is labelled in accordance with European Directive 2002/96/EU on Waste Electrical and Electronic Equipment - WEEE.

The directive provides a framework for the collection and recycling of old appliances, which is valid across the EU.

---

## Tips for saving energy

- Always use the right lid for the pan in question. Cooking without the lid requires four times as much energy.
- Use pots and pans with even bases. Using cookware with uneven bases increases energy consumption.
- The diameter of the base of your pot or pan should match the size of the hotplate. In particular, if pots that are too small are placed on the hotplate, energy is wasted.  
Please note: Cookware manufacturers often specify the diameter of the top of the pan. This is usually bigger than the diameter of the base of the pan.
- Use a small pan for small quantities of food. A larger, less full saucepan requires more energy.
- Use only a little water when cooking. This saves energy. It also preserves vitamins and minerals in vegetables.
- Switch to a lower heat setting as soon as possible.

---

# Induction cooking

---

## Advantages of induction cooking

Induction cooking involves a radical change to the traditional method of heating, as the heat is generated directly in the pan. For this reason, it offers a number of advantages:

- **Greater speed in cooking and frying;** as the pan is heated directly.
- **Reduced energy consumption**
- **Cleaner and easier to use;** spilt food does not burn as much on the hob.
- **Cooking control and safety;** the hob supplies or cuts off the heat as soon as the controls are operated. The induction hotplate stops supplying heat if the pan is removed before the power has been switched off.

---

## Suitable pans

### Ferromagnetic pans

**Ferromagnetic pans are the only pans which are suitable for induction cooking.** They can be made of:

- enamelled steel
- cast iron
- specially designed cookware for induction cooking made from stainless steel.

### Special pans for induction cooking

Other types of special pans are available for induction cooking, where the base of the pan is not entirely ferromagnetic. Check the diameter as this could affect the pan detection as well as the cooking results.

## Checking pans using a magnet

To find out whether the pans are suitable, check that they are attracted to a magnet. The manufacturer will usually indicate if their pans are suitable for induction cooking.

## Unsuitable pans

Never use pans made from:

- standard, high quality steel
- glass
- earthenware
- copper
- aluminium

## Characteristics of the base of the pan

The characteristics of the base of the pan can affect the evenness of the cooking.

Pans which are made from heat-diffusing materials (such as "sandwich" pans made from stainless steel) distribute the heat evenly, saving time and energy.

## No pan or incorrect size pan

If no pan is placed on the hotplate, or the pan is not made of a suitable material or it is not a suitable size, the heat setting on the hotplate indicator will flash. Place a suitable pan on the hotplate to stop the indicator flashing. If there is a delay of more than 90 seconds, the hotplate switches off automatically.

## Empty pans or pans with a thin base

Do not heat empty pans and do not use pans with thin bases. Although your hob is equipped with an internal safety system, empty cookware can heat up so quickly that the "automatic OFF" function does not have time to react and a very high temperature may be reached. The base of the pan could melt and damage the hob's glass surface. If this happens, do not touch the pan and switch off the hotplate. If it does not work after cooling, contact our After-Sales Service.

## Pan detection

Each hotplate has a minimum limit for pan detection which varies according to the material from which the pan being used is made. It is for this reason that you are recommended to use a hotplate which matches the diameter of the pan.

## Double or triple hotplate

These areas can detect pans of different sizes. The area will automatically adapt, depending on the pan material and its properties, activating only a single area or an entire area and supplying the right level of power for best cooking results.

---

# Getting to know your appliance

An overview of the models with their dimensions is given on *page 2*.

---

## The control panel

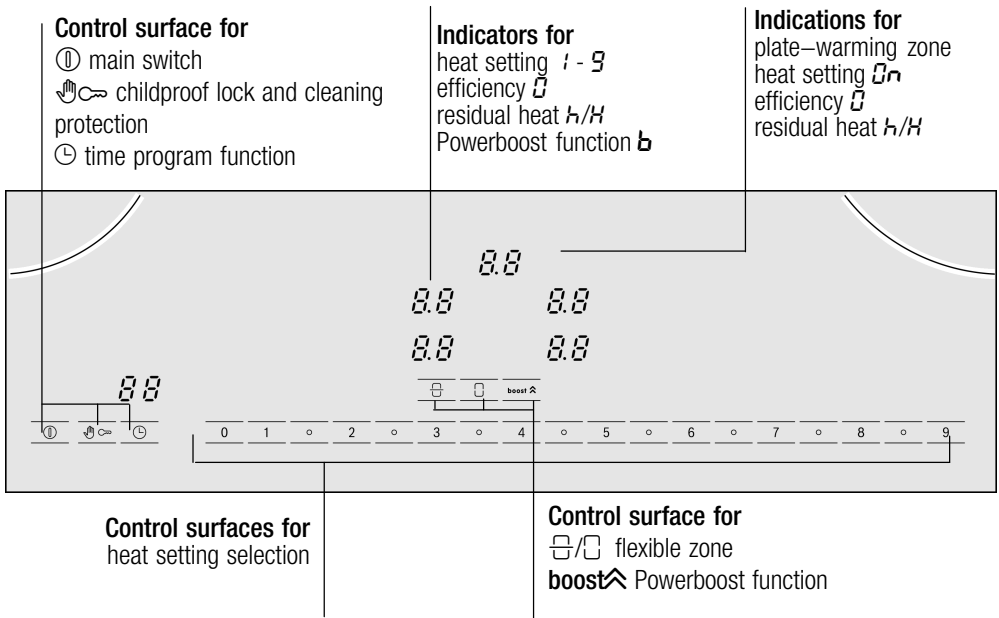

## The hotplates

Hotplate	Turning on and off
○ Single hotplate	Always use cookware of a suitable size.
□ Flexible zone	See the section on the flexible zone
○ Cooking zone	This zone is switched on automatically when using cookware whose base is the same size as the outer zone.
□ Resistive plate-warming zone	Switching on: press the symbol ○ for the plate-warming zone then the display shows <b>h/h</b> . Switching off: press the symbol ○ once more and the display shows <b>h</b> *

\* The residual heat indicator lights.

Only use pans which are suitable for induction cooking, see the section on “Suitable pans”.

## Residual heat warning light

The hob has a residual heat warning light for each hotplate to show those which are still hot. Avoid touching the hotplate when this warning light is on.

Although the hob is switched off, the warning light will stay lit while the hotplate is hot.

When the pan is removed before the hotplate is turned off, the **h/h** indicator and the selected heat setting will be displayed alternately.

---

# Programming the hob

This section shows how to adjust a hotplate. The table gives the settings and cooking times for various dishes.

---

## Switching the hob on and off

Switch the hob on and off using the main switch.

To switch on: touch the ① symbol. The indicator above the main switch and the ○ hotplate indicator light up. The hob is ready.

To switch off: Touch the ①, symbol until the indicator above the main switch and the ○ hotplate indicator go out. All hotplates are switched off. The residual heat indicator remains on until the hotplates have cooled down sufficiently.

### Note

The hob switches off automatically if all hotplates have been switched off for more than 15 seconds.

---

## Adjusting the hotplate

Select the required heat setting using symbols 1 to 9.

Heat setting 1 = minimum

Heat setting 9 = maximum

Each heat setting has an intermediate step.

This is shown by the .5 indicator (e.g. 1.5).

### Selecting the heat setting:

The hotplate must be connected.

1. Press the ○ symbol on the corresponding hotplate.  
The 0.0 indicator lights up.
2. Then press the symbol for the required heat setting.

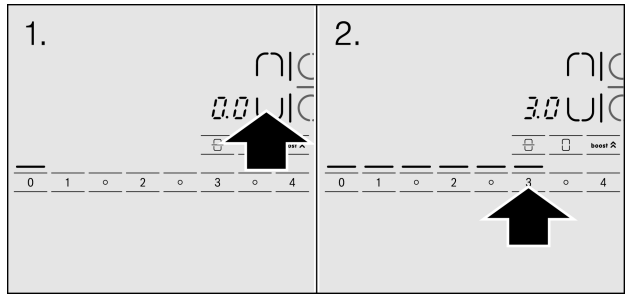

### Switching off the hotplate

To change the heat setting: Select the hotplate and then press the symbol for the required heat setting.

#### Warning:

The selected heat setting will flash if no pan is placed on the induction hotplate.

After a certain time, the hotplate switches off.

### Switching off the hotplate

Select the hotplate and then press the symbol for heat setting **0**.

## Cooking table

Some examples are given in the following table.

The cooking times depend on the type, weight and quality of the food being cooked. For these reason, results may vary.

	Slow cooking level	Duration of slow cooking in minutes
<b>Melting</b>		
Chocolate, ganache, butter, honey	1-2	-
Gelatin	1-2	-
<b>Heating and keeping warm</b>		
Vegetable and pulse stew (e.g. lentils)	1-2	-
Milk**	1.-2.	-
Sausages boiled in water**	3-4	-
<b>Defrosting and heating</b>		
Frozen spinach	2.-3.	5-15 min
Frozen goulash	2.-3.	20-30 min

	Slow cooking level	Duration of slow cooking in minutes
<b>Simmering, bringing to the boil over a low heat</b>		
Potato dumplings	4.-5.*	20-30 min
Fish	4-5*	10-15 min
White sauces, e.g. béchamel	1-2	3-6 min
Emulsions, e.g. Béarnaise, Hollandaise	3-4	8-12 min
<b>Boiling, steaming, sautéing</b>		
Rice (with double the amount of water)	2-3	15-30 min
Rice pudding	2-3	25-35 min
Potatoes (unpeeled)	4-5	25-30 min
Potatoes (peeled in salted water)	4-5	15-25 min
Pasta	6-7*	6-10 min
Stew, soup	3.-4.	15-60 min
Vegetables (fresh)	2.-3.	10-20 min
Vegetables (frozen)	3.-4.	7-20 min
Stews (in pressure cooker)	4.-5.	-
<b>Roasting</b>		
Joints of meat	4-5	50-60 min
Meat stews	4-5	60-100 min
Goulash	3.-4.	50-60 min
<b>Pan-frying</b>		
Fillets, with or without pastry or breadcrumb coating	6-7	6-10 min
Frozen fillets	6-7	8-12 min
Chops, with or without breadcrumb coating	6-7	8-12 min
Steak (3 cm thick)	7-8	8-12 min
Breast (2 cm thick)	5-6	10-20 min
Breast (frozen)	5-6	10-30 min
Whole fish and fish fillets (without breadcrumb coating)	5-6	8-20 min
Whole fish and fish fillets (breaded)	6-7	8-20 min
Frozen breaded fish, e.g. fish fingers	6-7	8-12 min
Prawns and shrimps	7-8	4-10 min
Frozen meals, e.g. sauté	6-7	6-10 min
Pancakes	6-7	fry individually
Omelette	3.-4.	fry individually
Fried eggs	5-6	3-6 min



	Slow cooking level	Duration of slow cooking in minutes
<b>Frying**</b> (150 g - 200 g per portion in 1-2 l of oil)		
Frozen food, e.g. chips, chicken nuggets	8-9	fry in batches
Frozen croquettes	7-8	
Dumplings	7-8	
Meat, e.g. chicken pieces	6-7	
Fish (breaded or beer-battered)	6-7	
Green vegetables, mushrooms, (breaded or beer-battered, e.g. mushrooms)	6-7	
Sweet pastries, e.g. doughnuts, battered fruit	4-5	
* Slow cook, uncovered		
** Uncovered		

---

# Flexible zone

This may be used as a single zone or as several individual zones, depending on the cooking needs at any given time.

## It works as follows

It consists of several independently controlled inductors. When the zone is working, those inductors that are not covered by cookware are automatically turned off.

## Advice on using cookware

To ensure that the cookware is detected and heat is distributed evenly, correctly centre the cookware:

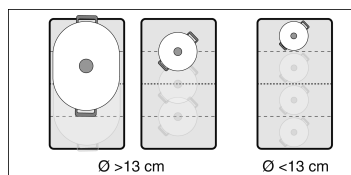

- in the upper or lower part of the flexible zone, when the cookware is smaller than 13 cm. (see diagram)
- or in one of the two halves of the flexible zone, when the cookware is larger than 13 cm. (see diagram)

When using cookware of a different size or made of a different material, noise and vibrations that do not affect correct working of the zone may occur.

---

## As one hotplate

The flexible zone is normally used as one single hotplate.

## How to activate

The hob must be switched on.

1. Select the flexible zone with the symbol  $\cup$  or  $\cap$ . The indicator  $\square.\square$  lights.
2. Select the heat setting using the symbols 0 to 9.
3. Changing the heat setting: Select the required zone then press the symbol corresponding to the required heat setting.

## To add another piece of cookware

Select the flexible zone then press the symbol  $\square$  so that the cookware is detected.

The previously selected heat setting is kept. Change the heat setting using the symbols 0 to 9.

## How to deactivate

Select the hotplate and press the  symbol.









---

## As two hotplates

The flexible zone can be used as two independent hotplates.

## How to activate

The hob must be switched on.

1. Select the flexible zone using the symbol  or , then press the symbol . The indicator – lights between the symbols  and .
2. Select the required hotplate using the symbol  or . The indicator  lights.
3. Select the heat setting using the symbols 0 to 9.

## How to deactivate

Select the hotplate and press the 0 symbol. The hotplate switches off.

## Indicators

When a hob is switched off and switched on again, the flexible zone returns to being one hotplate

---

# Childproof lock

The cooktop can be protected against being accidentally turned on to ensure that children do not switch on the elements.

---

## Switching the childproof lock on and off

The hob must be switched off.

To switch on: Touch the  symbol for approx. 4 seconds. The  symbol lights up for 4 seconds. The hob is locked.

To switch off: Touch the  symbol for approx. 4 seconds. The hob is unlocked.

---



## Switching the permanent childproof lock on and off

Using this function, the childproof lock is activated automatically whenever the hob is disconnected.

## Switching the permanent childproof lock on and off

See the section on “Basic settings”.

## Switching the hob on

Press the  until the beep sounds and the  indicator goes out.

The permanent childproof lock is deactivated. The hob can now be used.

---

# The Powerboost Function

The Powerboost function can be used to heat food more quickly than heat setting **9**.

## Restrictions when using

The Powerboost function may be used for all hotplates, provided that the other hotplate in the same group is not switched on. (see figure). Otherwise, **b** and **9** will flash on the display corresponding to the selected hotplate and it will be automatically set to heat setting **9**.

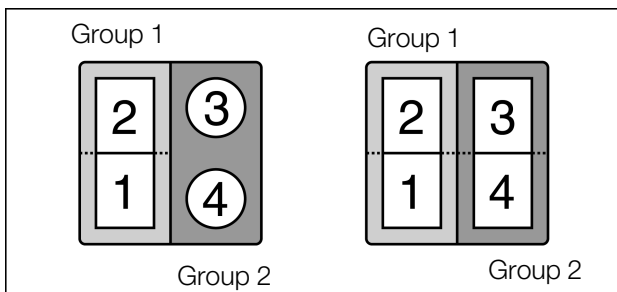

## How to activate it

Follow the steps below:

1. Select a hotplate.
2. Press the **boost**  symbol.  
You have now activated the function.

## How to deactivate it

Follow the steps below:

1. Select a hotplate.
2. Press the **boost**  symbol.  
The Powerboost function has been deactivated.



**In certain circumstances, the Powerboost function may be deactivated automatically to protect the internal electronic components of the hob.**

---

# Timer function

This function can be used in two different ways:

- to switch a hotplate off automatically
- as a cooking timer





---

## Automatic hotplate switch-off

You enter a cooking time for the relevant hotplate. When the cooking time has elapsed, the hotplate switches off automatically.

## Setting a cooking time

The hotplate must be selected and set.

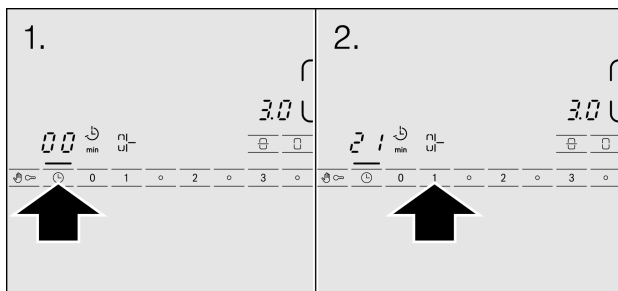

1. Touch the  symbol twice.  
The  indicator for the desired hotplate lights up.  
The  symbol appears and  lights up in the timer display.





2. Within the next 10 seconds, set the desired cooking time from the range of settings.

The time counts down.

## When the cooking time has elapsed

When the cooking time has elapsed, the hotplate switches off.  lights up in the hotplate display. A signal sounds.  lights up in the timer display for 10 seconds. Touch the  symbol. The displays go out and the signal ceases.

## Changing or cancelling the cooking time

Select the hotplate and touch the  symbol twice. Change the cooking time or set to  in the range of settings.

## Notes

If you have set the kitchen timer, the time it has been set to will always be shown in the timer display. To call up the cooking time for a hotplate, select the hotplate and touch the  symbol twice. The cooking time appears for 10 seconds in the timer display.

If you have set cooking times for several hotplates, the cooking time for the selected hotplate always appears in the timer display.



You can set a cooking time of up to 99 minutes.

---

## Kitchen timer



You can use the kitchen timer to set a time of up to 99 minutes. It runs independently of all the other settings.

### Setting procedure



1. Touch the  symbol, the  indicator for the kitchen timer lights up.  lights up in the timer display.
2. Set the desired time in the control panel.

The timer starts counting down after a few seconds.

### When the cooking time has elapsed

A signal sounds once the time has elapsed.  lights up in the timer display. The  indicator for the kitchen timer lights up. After 10 seconds, the indicator switches off.

### Changing the time

Touch the  symbol, the  indicator for the kitchen timer lights up. Set the desired time in the control panel.

---

## Control panel pause

Cleaning the control panel while the hob is on may change the settings.

To avoid this, the hob has a control panel pause function.

Press the  symbol. The control panel is locked for approximately 35 seconds.

The surface of the control panel can now be cleaned without risk of changing the settings.

After the time has elapsed, a warning beep will sound and the function is deactivated.

The control panel lock has been deactivated.

### Note

The lock does not apply to the  symbol or to the main switch. The control panel pause function can be deactivated and the hob can be switched off at any time.

---

# Automatic time limit

If a hotplate is in use for a long time without the setting being changed, the automatic time limit is activated.

The hotplate stops heating. *F* and *B* flash alternately on the hotplate display.

The display goes out when you touch any control panel. You can make new settings.

When the time limit is activated depends on the heat setting selected (1 to 10 hours).

---

## Basic settings

The hob offers various basic settings. Some of these settings can be modified.

---

<i>c 1</i>	<b>Permanent childproof lock</b> The hob is automatically locked once switched off.	<i>0</i> childproof lock deactivated* <i>1</i> childproof lock activated
<i>c 2</i>	<b>Deactivating the beep</b> Short beep to confirm that a symbol button has been pressed or long beep to warn that an incorrect operation has been performed.	<i>0</i> majority of beeps deactivated <i>1</i> some beeps deactivated <i>2</i> all beeps activated*
<i>c 5</i>	<b>Hotplate automatic OFF function</b> The hotplate always switches off automatically once the time set on the timer has elapsed.	<i>0</i> automatic OFF deactivated* <i>1</i> minute = minimum time <i>99</i> minutes= maximum time
<i>c 6</i>	<b>Alarm duration of time programming function</b> An alarm sounds once the period set on the timer elapses or after the time elapses for an area to be automatically switched off.	<i>1</i> 10 seconds <i>2</i> 30 seconds <i>3</i> 1 minute

---



<b>c 7</b>	<b>Power Management Function</b> This limits the total power of the hob. There are 17 setting levels. Increasing the setting level increases the power of the hob by 500 W.	<b>7</b> = 1000 W minimum power <b>7 - 8.</b> = from 1500 to 8500W <b>9</b> = 9000W maximum power
<b>c 9</b>	<b>Hotplate selection</b> The last programmed hotplate remains selected as the basic setting. This can be changed. The hotplate will only remain selected for 5 seconds.	<b>0</b> basic setting* <b>1</b> 5-second limit
<b>c 0</b>	<b>Restoring the default hob settings</b> This clears all the customised settings	<b>0</b> customised settings <b>1</b> restore default settings*

\* Basic settings

## Changing the basic settings

The hob must be switched off.

1. Switch on the hob.
2. Within the next 10 seconds, touch the  symbol for 4 seconds.

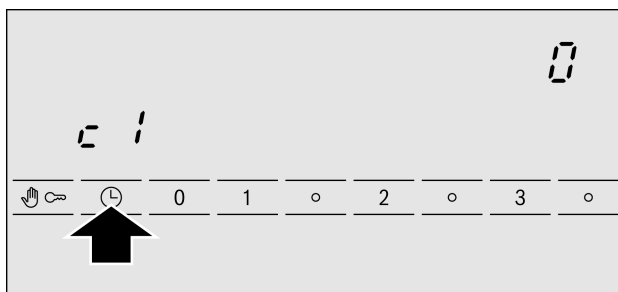

**c 7** appears in the left-hand display and **0** in the right-hand display.

3. Touch the  symbol repeatedly until the desired display appears in the left-hand display.

- Set the desired value on the control panel.

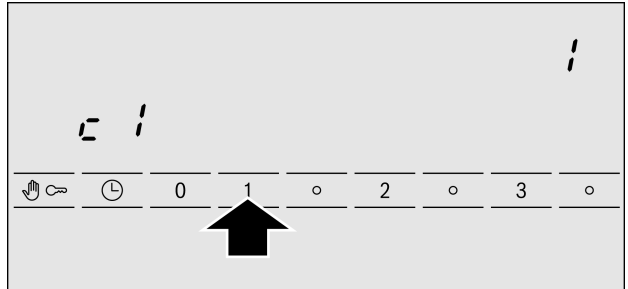

- Touch the  symbol for 4 seconds.

The setting is activated.

## Switching off

To exit the basic setting, switch off the hob with the main switch and make new settings.

---

# Care and cleaning

The recommendations and warnings given in this section are designed to help you clean and maintain your cooking hob in optimum condition

---

## Cooking hob

### Cleaning

Clean the hob after each use. This will prevent spillages from burning.

Only clean the hob when it has cooled down sufficiently.

Only use cleaning products which are recommended for cooking hobs. Follow the instructions provided on the product packaging.

Never use:

- Abrasive products
- Aggressive cleaning products, such as stain removers and oven sprays
- Sponges which may scratch
- High–pressure cleaners or steam cleaners

## Glass scrapers

Remove stubborn dirt with a glass scraper.

1. Remove the guard from the scraper
2. Clean the surface of the cooking hob with the blade.

Do not use the scraper cover to clean the surface of the cooking hob as this could scratch the surface.



The blade is very sharp. Danger of cuts. Protect the blade when it is not in use. Replace the blade immediately when it shows signs of imperfections.

## Care

Apply an additive to preserve and protect your cooking hob. Observe the recommendations and warnings given in this pack.

---

## Hob surround

To prevent damage to the hob surround, follow the advice below:

- Only use warm water with a little soap
- Never use sharp or abrasive products
- Do not use the glass scraper

---

# Fixing malfunctions

Malfunctions are generally caused by minor faults. Before contacting Technical assistance, ensure you have read the following recommendations and warnings.

Display	Malfunction	Measure
none	The electric power supply has been interrupted.	Use other electrical appliances to check if there has been a break in the electric power supply.
	The appliance has not been correctly connected according to the connection drawing.	Check that the appliance has been connected correctly according to the connection drawing.
	Electronic system malfunction.	If the checks above do not remedy the malfunction, contact technical assistance.
<i>E</i> flashes	The control panel is damp or an object is resting on it	Dry the control panel area or remove the object.
<i>E</i> + number/ <i>d</i> + number/ <i>E</i> + number/	Electronic system malfunction	Disconnect the cooking hob from the mains. Wait a few seconds before connecting it again. If the indication continues, notify the technical assistance service.
<i>F0/F9</i>	There is an internal error in the system	Disconnect the cooking hob from the mains. Wait a few seconds before connecting it again. If the indication continues, notify the technical assistance service.
<i>F2</i>	The electronic system has overheated and the corresponding hotplate has been switched off	Wait until the electronic system has cooled down sufficiently. Then press any symbol on the hob. If the indication continues, notify the technical assistance service.
<i>F4</i>	The electronic system has overheated and all the hotplates have been switched off	Wait until the electronic system has cooled down sufficiently. Then press any symbol on the hob. If the indication continues, notify the technical assistance service.

Display	Malfunction	Measure
<b>U1</b>	Incorrect supply voltage, outside normal operating limits	Please contact the local electricity board.
<b>U2/U3</b>	The hotplate has overheated and has switched off in order to protect the hob	Wait until the electronic system has cooled down sufficiently before switching the hob back on.

**Do not rest hot pans on the control panel.**

## Normal noises heard during appliance operation

Induction heating technology is based on the creation of electromagnetic fields which enable heat to be generated directly in the base of the pan. Depending on the construction of the pan, these electromagnetic fields may produce certain noises or vibrations as detailed below:

### A low buzzing noise, like a transformer

This noise is produced when cooking with high power levels. It is the quantity of energy transferred from the cooking hob to the pan which causes the noise. This noise will disappear or lessen as the power level is reduced.

### A low whistle

This noise is produced when the pan is empty. The noise disappears as soon as food or water is added to the pan.

### Sizzling

This noise is produced by pans which are composed of different superimposed materials. The noise is caused by the vibration of the contact surfaces of the various superimposed materials. This noise comes from the cookware. The quantity of food and method of cooking may vary.

### High-pitched whistling

This noise is mostly produced by pans which are composed of different superimposed materials, as soon as these are used at full heating power and at the same time on two hotplates. This whistling disappears or lessens as soon as the power is reduced.

## Noise from the fan

To run the electronic system properly, the cooking hob must operate at a controlled temperature. To do this, the cooking hob is fitted with a fan which comes on after each temperature detected using different power levels. The fan will also continue to operate after the cooking hob has been switched off, if the temperature detected is still too high.

The noises described in this section are normal. They are part of induction heating technology and do not indicate a malfunction.

---

## After-sales service

Our after-sales service is there for you if your appliance should need to be repaired. You will find the address and telephone number of your nearest after-sales service point in the phone book. The after-sales service centres listed will also be happy to give you the details of an after-sales service point near you.

### E number and FD number

Please quote the E number (product number) and the FD number (production number) of your appliance when contacting the after-sales service. The rating plate bearing these numbers can be found on the appliance certificate.

Please note that a visit from an after-sales service engineer is not free of charge, even during the warranty period.

DE <http://www.bosch-hausgeraete.de>  
GB <http://www.boschappliances.co.uk>  
FR <http://www.bosch-electromenager.com>  
NL <http://www.bosch-huishoudelijke-apparaten.nl>  
FI <http://www.bosch-kodinkoneet.com>  
DK <http://www.bosch-hvidevarer.com>  
ES <http://www.bosch-ed.com>  
PT <http://www.bosch.pt>  
BE <http://www.electro.bosch.be>  
AU <http://www.bosch.com.au>  
AT <http://www.bosch-hausgeraete.at>  
BR <http://www.boschelectrodomesticos.com.br>  
GR <http://www.bosch-home.gr>  
US <http://www.bosch-appliances.com>