

Safety instructions

- The washing machine is heavy - take care when lifting.
- **Caution:** frozen hoses may rip/burst. Do not install the washing machine in areas exposed to frost or outdoors.
- The washing machine could be damaged. Do not lift the appliance by protruding components (e.g. the washing machine door, the cover, the front panel or the outer door in case of deco models).
- In addition to the instructions provided in this document, special regulations from the relevant water and electric utility companies may apply.
- If in doubt, have a technician connect the appliance.
- Lay hoses and cables in such a way that there is no risk of tripping.

Installation surface

- The machine must be stable so that it does not move around.
- The installation surface must be firm and level.
- Soft floors/floor coverings are not suitable.

Installation on a pedestal

- The feet of the washing machine **must** be secured with holding brackets*.
* order no. WMZ2200, WX9756, CZ110600, Z7080X0

Installation on a wood joist floor

- If possible, place the washing machine in a corner.
- Screw a water-resistant wooden board (min. 30 mm thick) to the floor.
- The feet of the washing machine **must** be secured with holding brackets*.
* order no. see above

Installation on a platform with drawer*

- * order no. WMZ20490, WZ20490

Installing the appliance

- Install the appliance before connecting it to the power supply.

Installation in a kitchenette (underneath the worktop or fitted in a cabinet)

- Recess width of 60 cm required.
- Only install the washing machine underneath a continuous worktop that is securely connected to adjacent cabinets.

Installation underneath the worktop

- **Risk of electric shock!**
- Instead of the appliance covering plate, you **must** have a metal cover*.
* order no. WMZ20331, WZ20331
- Recess width of 60 cm required.

Scope of delivery depending on model

Moisture inside the drum is due to final testing.

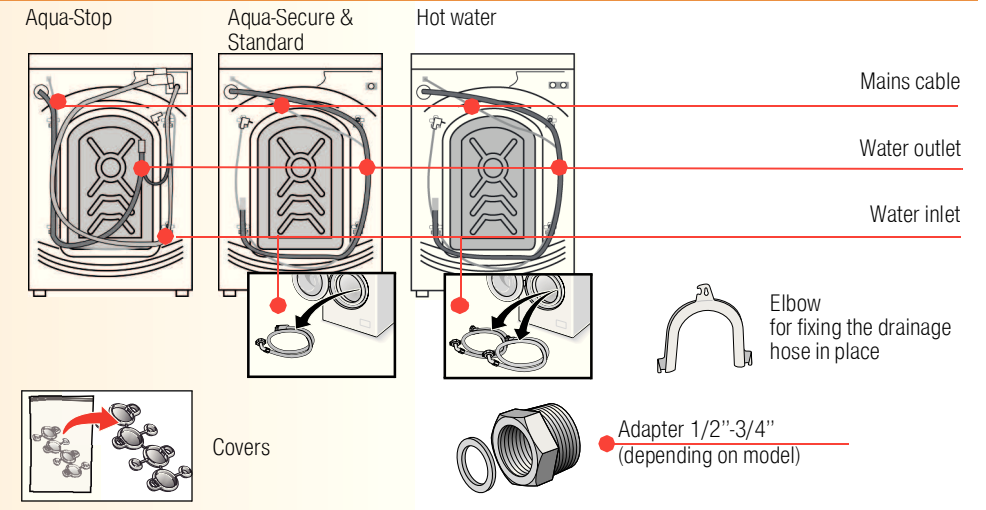

- Also required, depending on the connection:**
- 1 hose clamp Ø 24-40 mm (exclusive dealers) to connect to a siphon → page 4; water connection.
- Useful tools**
- Spirit level for installation.
 - Wrenches
 - WAF 13: for loosening transport braces → page 3 and
 - WAF 17: for aligning appliance feet → page 5.

Hose and cable lengths depending on model

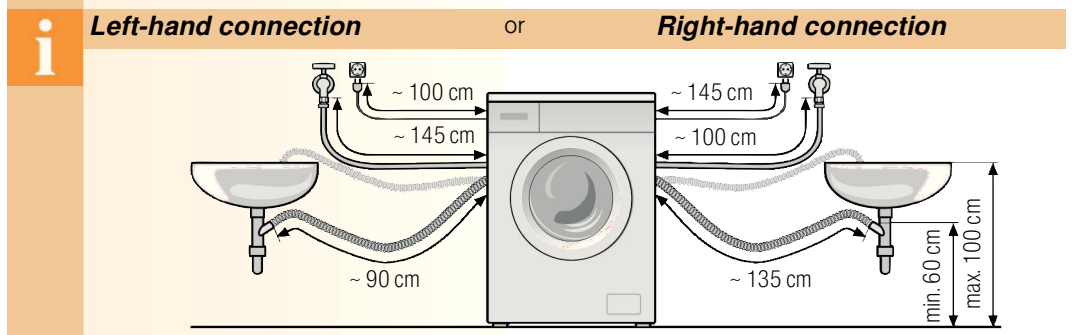

- Available from specialist dealers/the after-sales service:
- Extension for Aqua-Stop or cold-water inlet hose (approx. 2.50 m), order no. WMZ2380, WZ10130, CZ11350, Z7070X0
 - Longer inlet hose (approx. 2.20 m) for standard model.

Removing the transport braces

- Before using the appliance for the first time, make sure that you completely remove transport braces and keep them for subsequent transportation.
- If you need to transport the appliance at a later date, always re-affix the transport braces to prevent damage to the machine. → page 6.
- Store the screw and sleeve together.

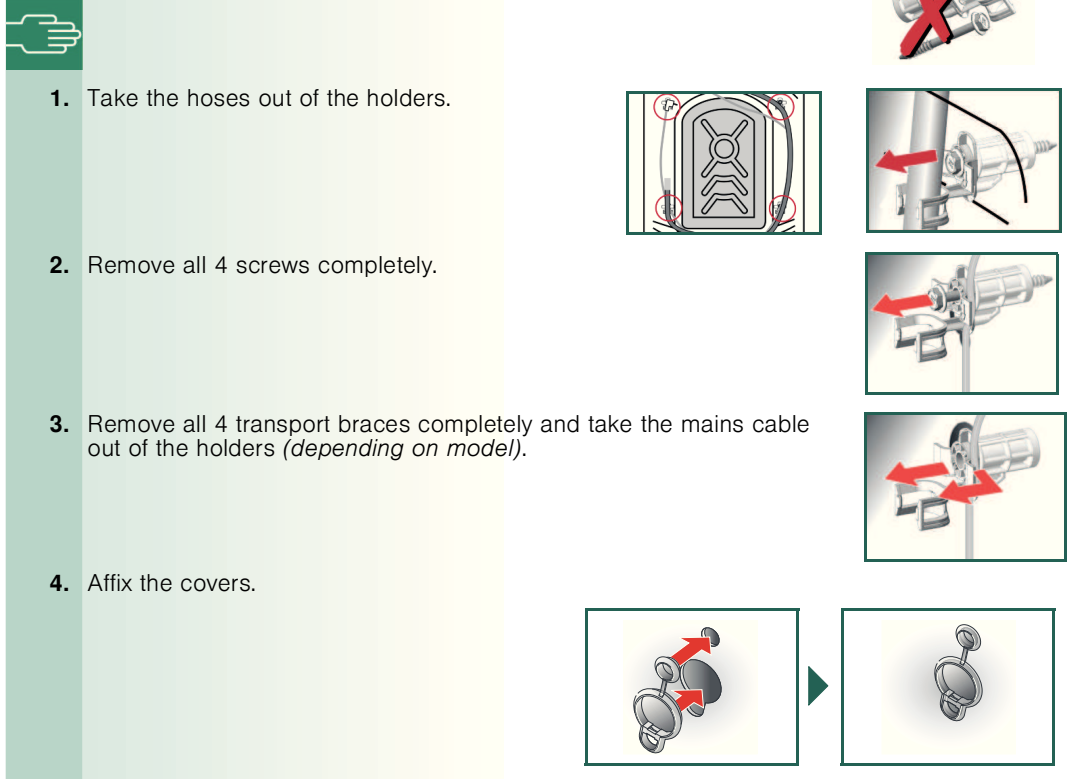

Water connection depending on model

- **Risk of electric shock.** Do not immerse the Aqua-Stop safety device in water (contains an electric valve).
- To prevent leaks or water damage, observe the instructions in this section.
- **Caution:** only operate the washing machine using cold drinking water (in case of models featured for hot water: maximum temperature 60 °C).
- Do not connect to the mixer tap of an unpressurised hot-water boiler.
- Do not use a used inlet hose. Only use the inlet hose supplied or one which was purchased from an authorised specialist dealer.
- If in doubt, have a technician connect the appliance.

Water connection depending on model

Water inlet

- **Caution:** do not bend, squash, modify or cut through (otherwise its strength is no longer guaranteed).
- **Optimum water pressure in the supply network: 200-1,000 kPa (2-10 bar)**
- When the tap is on, the water flow is at least 10 l/min (1-2 bar: 6 l/min; with 1 bar consumption parameters cannot be assured).
- If the water pressure is higher than this, a pressure reducing valve must be installed

Connection to the tap:

Aqua-Stop, Aqua-Secure, Standard:

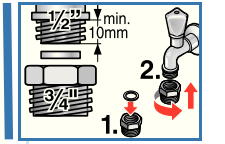

Connection to the machine:

no necessary with Aqua-Stop, fixed installation;

Aqua-Stop, Aqua-Secure

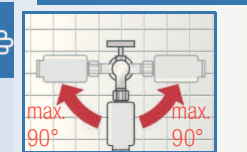

Standard

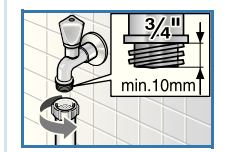

Aqua-Secure, Standard

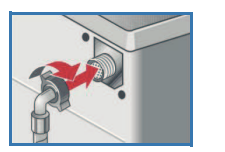

1. Connect the water inlet hose (hoses) to the tap (taps) 3/4" = 26,4 mm and to the solenoid valves.
Caution: only tighten the screw connections by hand.
2. Open the water tap (taps) carefully, checking the leak tightness of the connection points.
Caution: the screw connection is under mains water pressure.

Connection in case of hot water models:

- COLD – Cold water
- HOT – Hot water max. 60 °C (red)
- If no hot water connection is present:
 - only connect the cold water inlet hose and
 - cover the hot water connection on the appliance so that it is kept free of dirt.

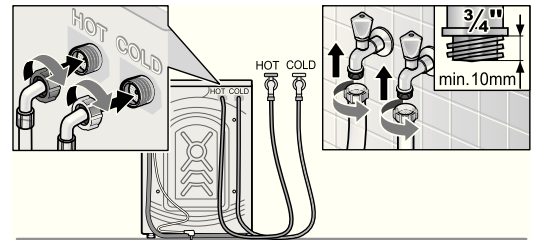

Water outlet

- **Caution:** do not bend or pull lengthways.
- **Height difference between the installation surface and the drain:**
min. 60 cm - max. 100 cm

Outlet in a sink:

- **Caution:** secure the drain hose from slipping out.
- **Caution:** the plug must not block drainage from the sink. During pumping, check whether the water is draining away quickly enough. The end of the drain hose must not be immersed in the water pumped out. This risks water being sucked back into the washing machine.

Drainage into a siphon:

- **Caution:** the connection point must be secured with a hose clamp, Ø 24-40 mm (exclusive dealers).

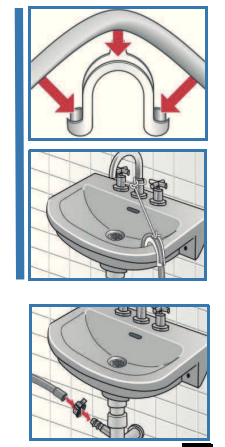

Alignment

 Intense noise formation, vibrations and "wandering" may be the result of incorrect alignment.

Aligning the washing machine with a spirit level

1. Loosen the lock nut using a wrench, by turning it in a clockwise direction.

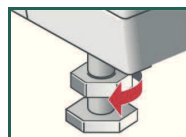

2. Change the height by turning the appliance feet.
Caution: all four appliance feet must be firmly on the ground. The washing machine must not wobble.

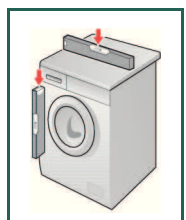

Check the alignment of the washing machine with a spirit level and adjust if necessary.

3. Tighten the lock nut against the housing.
In doing so, hold the foot tight and do not adjust its height.

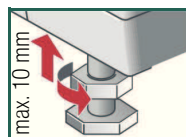

Caution: the lock nuts on all four appliance feet must be screwed tightly against the housing.

Electrical connection

- The washing machine must only be connected to an alternating current via a properly installed earthed socket.
- The power supply and voltage indicated on the washing machine (rating plate) must be the same.
- The connected load and fuse required are specified on the rating plate.
- Make sure that:
 - the mains plug fits the socket,
 - the cable cross-section is adequate,
 - the earthing system is properly installed.
- (If this is necessary), the mains cable may only be replaced by a qualified electrician. Replacement mains cables are available from the after-sales service.
- Do not use multiple plugs/couplings or extension cables.
- If a residual current circuit breaker is used, only use a type which displays this symbol: . Only this symbol guarantees compliance with the currently applicable regulations.
- Do not plug in or unplug the mains plug with wet hands. Pull the appliance plug out of the socket at the plug only, not by the cable.



Transportation, e.g. when moving home

1. Before transporting the washing machine:

1. Turn off the tap.
2. Drain residual water → *Operating instructions*; Maintenance - drain pump.
3. Release the water pressure in the inlet hose → *Operating instructions*; Maintenance - filter in water inlet.
4. Disconnect the washing machine from the power supply.
5. Dismantle the hoses.

2. Preparing and installing transport braces:

1. Remove all covers and store them.
2. Affix all transport braces. In doing so, turn the bend on the hose holders inwards. Clamp the mains cable in the holders. Tighten the screws.

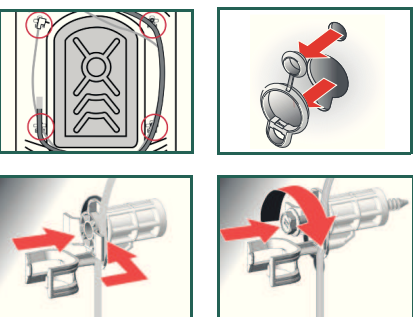

 After transportation, the transport braces **must** be removed. → page 3.

 To prevent unused detergent from flowing straight into the drain during the next wash: Pour 2 litres of water into compartment II and start the **Empty** programme.

Technical specifications

- Dimensions (width x depth x height)** 60 x 55 x 85 cm
- Weight** 66 – 73 kg *depending on model*
- Mains connection** Nominal voltage 220-240 V, 50 Hz
Nominal current 10 A
Nominal power 2,300 W
- Water pressure** 200-1000 kPa (2-10 bar)

After-sales service

- If you cannot rectify the fault yourself (*Operating instructions*; What to do if... → page 11), please contact our after-sales service. We will always find a suitable solution and will avoid a visit from a service technician wherever possible.
- The contact details for all countries can be found in the enclosed after-sales service directory.
- Please give the after-sales service the product number (E-Nr.) and the production number (FD) of the appliance.

E-Nr. _____ FD _____

Product number Production number

You will find this information on the inside of the washing machine door, on the opened service flap or at the rear of the appliance (depending on the model).

- Rely on the professionalism of the manufacturer.** Please contact us. This will ensure that the repair is carried out by trained service technicians who arrive equipped with genuine spare parts for your appliance.

Aqua-Stop warranty only for appliances with Aqua-Stop

In addition to warranty claims against the vendor from the purchase agreement and to our appliance warranty, we will pay damages under the following conditions:

1. If a fault in our Aqua-Stop system causes water damage, we will reimburse damages caused to private customers.
2. The liability guarantee is valid for the service life of the appliance.
3. It is a prerequisite of all warranty claims that the appliance with Aqua-Stop must have been set up and connected correctly in accordance with our instructions; this also includes a correctly fitted Aqua-Stop extension (original accessories). Our warranty goes not cover defective power cables or fittings between the Aqua-Stop connection and the tap.
4. Appliances with Aqua-Stop do not need to be supervised during operation, nor secured afterwards by turning off the tap. The tap only needs to be turned off if you are away from home for a long period, e.g. for several weeks' holiday.

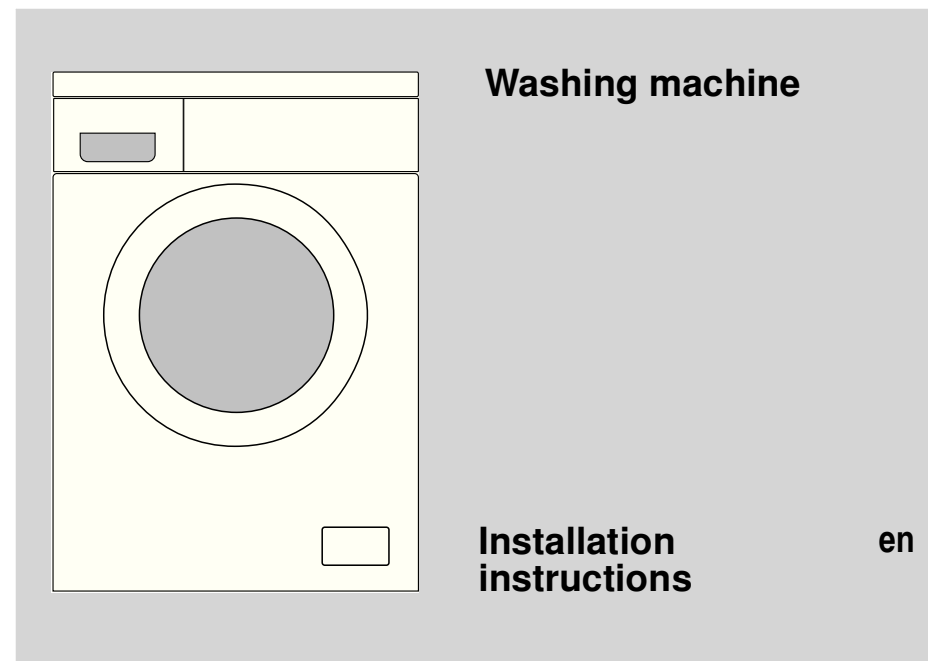

Contents

	Page
■ Safety instructions	1
■ Installation surface	1
■ Installing the appliance	1
■ Scope of delivery	2
■ Hose and cable lengths	2
■ Removing the transport braces	3
■ Water connection	3/4
■ Alignment	5
■ Electrical connection	5
■ Transportation, e.g. when moving home	6
■ Technical specifications	6
■ After-sales service	7
■ Aqua-Stop warranty	7

 **Read these instructions before switching on the washing machine. Also observe the separate instruction manual. Keep all documents for use in the future or for the subsequent owner.**

! Safety instructions

- The washing machine is heavy - take care when lifting.
- Caution: frozen hoses may rip/burst. Do not install the washing machine in areas exposed to frost or outdoors.
- The washing machine could be damaged. Do not lift the appliance by protruding components (e.g. the washing machine door, the cover, the front panel or the outer door in case of deco models).
- In addition to the instructions provided in this document, special regulations from the relevant water and electric utility companies may apply.
- If in doubt, have a technician connect the appliance.
- Lay hoses and cables in such a way that there is no risk of tripping.

Installation surface

- i - The machine must be stable so that it does not move around.
- The installation surface must be firm and level.
- Soft floors/floor coverings are not suitable.

! Installation on a pedestal

- The feet of the washing machine **must** be secured with holding brackets*.
- * order no. WMZ2200, WX9756, CZ110600, Z7080X0

! Installation on a wood joist floor

- If possible, place the washing machine in a corner.
- Screw a water-resistant wooden board (min. 30 mm thick) to the floor.
- The feet of the washing machine **must** be secured with holding brackets*.
- * order no. see above

Installation on a platform with drawer*

- * order no. WMZ20490, WZ20490

Installing the appliance

- ! - Install the appliance before connecting it to the power supply.

i Installation in a kitchenette (underneath the worktop or fitted in a cabinet)

- Recess width of 60 cm required.
- Only install the washing machine underneath a continuous worktop that is securely connected to adjacent cabinets.

! Installation underneath the worktop

Risk of electric shock!

- i - Instead of the appliance covering plate, you **must** have a metal cover*.
- * order no. WMZ20331, WZ20331
- Recess width of 60 cm required.

Scope of delivery depending on model

Moisture inside the drum is due to final testing.

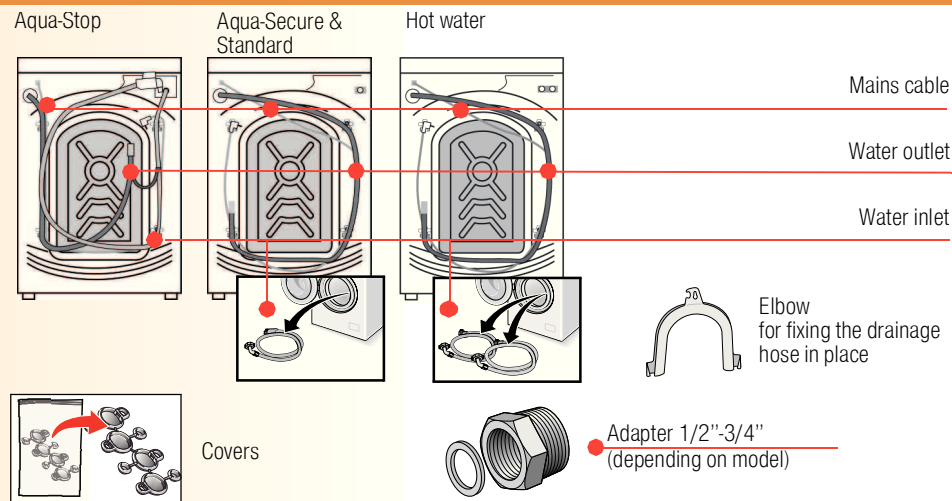

Also required, depending on the connection:

- 1 hose clamp \varnothing 24-40 mm (exclusive dealers) to connect to a siphon → page 4; water connection.

Useful tools

- Spirit level for installation.
- Wrenches
- WAF 13: for loosening transport braces → page 3 and
- WAF 17: for aligning appliance feet → page 5.

Hose and cable lengths depending on model

i Left-hand connection or Right-hand connection

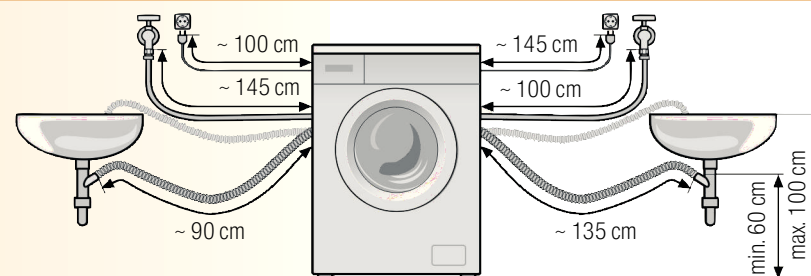

Available from specialist dealers/the after-sales service:

- Extension for Aqua-Stop or cold-water inlet hose (approx. 2.50 m), order no. WMZ2380, WZ10130, CZ11350, Z7070X0
- Longer inlet hose (approx. 2.20 m) for standard model.

Removing the transport braces



- Before using the appliance for the first time, make sure that you completely remove transport braces and keep them for subsequent transportation.
- If you need to transport the appliance at a later date, always re-affix the transport braces to prevent damage to the machine. → page 6.
- Store the screw and sleeve together.



1. Take the hoses out of the holders.



2. Remove all 4 screws completely.

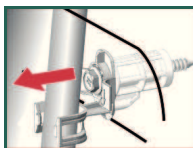

3. Remove all 4 transport braces completely and take the mains cable out of the holders (depending on model).

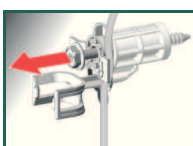

4. Affix the covers.

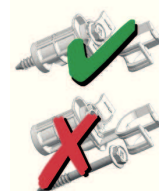
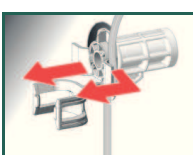

Water connection depending on model

Water inlet

Caution: do not bend, squash, modify or cut through (otherwise its strength is no longer guaranteed).

Optimum water pressure in the supply network: 200-1,000 kPa (2-10 bar)

- When the tap is on, the water flow is at least 10 l/min (1-2 bar: 6 l/min; with 1 bar consumption parameters cannot be assured).
- If the water pressure is higher than this, a pressure reducing valve must be installed

Connection to the tap:

Aqua-Stop, Aqua-Secure, Standard:

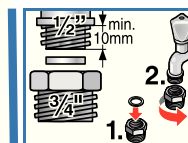

Connection to the machine:

no necessary with Aqua-Stop, fixed installation;

Aqua-Stop, Aqua-Secure

Standard

Aqua-Secure, Standard

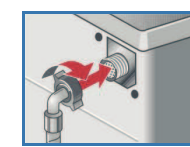
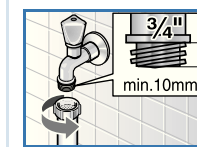
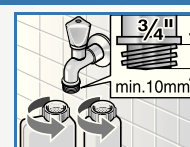
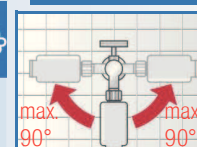

1. Connect the water inlet hose (hoses) to the tap (taps) 3/4" = 26,4 mm and to the solenoid valves.
Caution: only tighten the screw connections by hand.
2. Open the water tap (taps) carefully, checking the leak tightness of the connection points.
Caution: the screw connection is under mains water pressure.

Connection in case of hot water models:

COLD – Cold water

HOT – Hot water max. 60 °C (red)

- If no hot water connection is present:
 - only connect the cold water inlet hose and
 - cover the hot water connection on the appliance so that it is kept free of dirt.

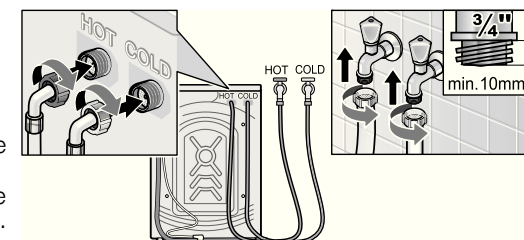

Water connection depending on model



- **Risk of electric shock.** Do not immerse the Aqua-Stop safety device in water (contains an electric valve).
- To prevent leaks or water damage, observe the instructions in this section.
- **Caution:** only operate the washing machine using cold drinking water (in case of models featured for hot water: maximum temperature 60 °C).
- Do not connect to the mixer tap of an unpressurised hot-water boiler.
- Do not use a used inlet hose. Only use the inlet hose supplied or one which was purchased from an authorised specialist dealer.
- If in doubt, have a technician connect the appliance.

Water outlet

Caution: do not bend or pull lengthways.

Height difference between the installation surface and the drain:

min. 60 cm - max. 100 cm

Outlet in a sink:

Caution: secure the drain hose from slipping out.

Caution: the plug must not block drainage from the sink. During pumping, check whether the water is draining away quickly enough. The end of the drain hose must not be immersed in the water pumped out. This risks water being sucked back into the washing machine.

Drainage into a siphon:

Caution: the connection point must be secured with a hose clamp, Ø 24-40 mm (exclusive dealers).

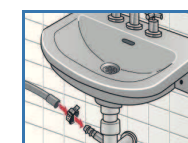
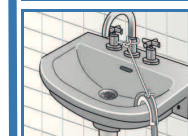
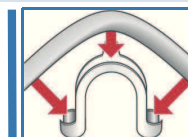

Alignment

 Intense noise formation, vibrations and "wandering" may be the result of incorrect alignment.

Aligning the washing machine with a spirit level

1. Loosen the lock nut using a wrench, by turning it in a clockwise direction.
2. Change the height by turning the appliance feet.
Caution: all four appliance feet must be firmly on the ground. The washing machine must not wobble. Check the alignment of the washing machine with a spirit level and adjust if necessary.
3. Tighten the lock nut against the housing.
In doing so, hold the foot tight and do not adjust its height.
Caution: the lock nuts on all four appliance feet must be screwed tightly against the housing.

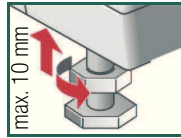
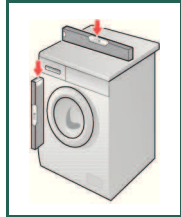
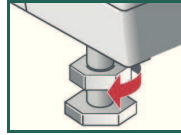

Electrical connection

- The washing machine must only be connected to an alternating current via a properly installed earthed socket.
- The power supply and voltage indicated on the washing machine (rating plate) must be the same.
- The connected load and fuse required are specified on the rating plate.
- Make sure that:
 - the mains plug fits the socket,
 - the cable cross-section is adequate,
 - the earthing system is properly installed.
- (If this is necessary), the mains cable may only be replaced by a qualified electrician. Replacement mains cables are available from the after-sales service.
- Do not use multiple plugs/couplings or extension cables.
- If a residual current circuit breaker is used, only use a type which displays this symbol: . Only this symbol guarantees compliance with the currently applicable regulations.
- Do not plug in or unplug the mains plug with wet hands. Pull the appliance plug out of the socket at the plug only, not by the cable.



Manufacturer -> Operating instructions

Transportation, e.g. when moving home

1. Before transporting the washing machine:

1. Turn off the tap.
2. Drain residual water → Operating instructions; Maintenance - drain pump.
3. Release the water pressure in the inlet hose → Operating instructions; Maintenance - filter in water inlet.
4. Disconnect the washing machine from the power supply.
5. Dismantle the hoses.

2. Preparing and installing transport braces:

1. Remove all covers and store them.
2. Affix all transport braces. In doing so, turn the bend on the hose holders inwards. Clamp the mains cable in the holders. Tighten the screws.

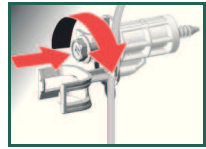
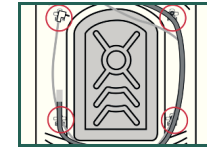

After transportation, the transport braces **must** be removed. → page 3.



To prevent unused detergent from flowing straight into the drain during the next wash: Pour 2 litres of water into compartment II and start the **Empty** programme.

Technical specifications

- **Dimensions (width x depth x height)** 60 x 55 x 85 cm
- **Weight** 66 – 73 kg depending on model
- **Mains connection** Nominal voltage 220-240 V, 50 Hz
Nominal current 10 A
Nominal power 2,300 W
- **Water pressure** 200-1000 kPa (2-10 bar)

After-sales service

- If you cannot rectify the fault yourself (*Operating instructions*; What to do if... → page 11), please contact our after-sales service. We will always find a suitable solution and will avoid a visit from a service technician wherever possible.
- The contact details for all countries can be found in the enclosed after-sales service directory.
- Please give the after-sales service the product number (E-Nr.) and the production number (FD) of the appliance.

E-Nr. _____ FD _____

Product number Production number

You will find this information on the inside of the washing machine door, on the opened service flap or at the rear of the appliance (depending on the model).

- **Rely on the professionalism of the manufacturer.** Please contact us. This will ensure that the repair is carried out by trained service technicians who arrive equipped with genuine spare parts for your appliance.

Aqua-Stop warranty only for appliances with Aqua-Stop

In addition to warranty claims against the vendor from the purchase agreement and to our appliance warranty, we will pay damages under the following conditions:

1. If a fault in our Aqua-Stop system causes water damage, we will reimburse damages caused to private customers.
2. The liability guarantee is valid for the service life of the appliance.
3. It is a prerequisite of all warranty claims that the appliance with Aqua-Stop must have been set up and connected correctly in accordance with our instructions; this also includes a correctly fitted Aqua-Stop extension (original accessories).
Our warranty goes not cover defective power cables or fittings between the Aqua-Stop connection and the tap.
4. Appliances with Aqua-Stop do not need to be supervised during operation, nor secured afterwards by turning off the tap.
The tap only needs to be turned off if you are away from home for a long period, e.g. for several weeks' holiday.

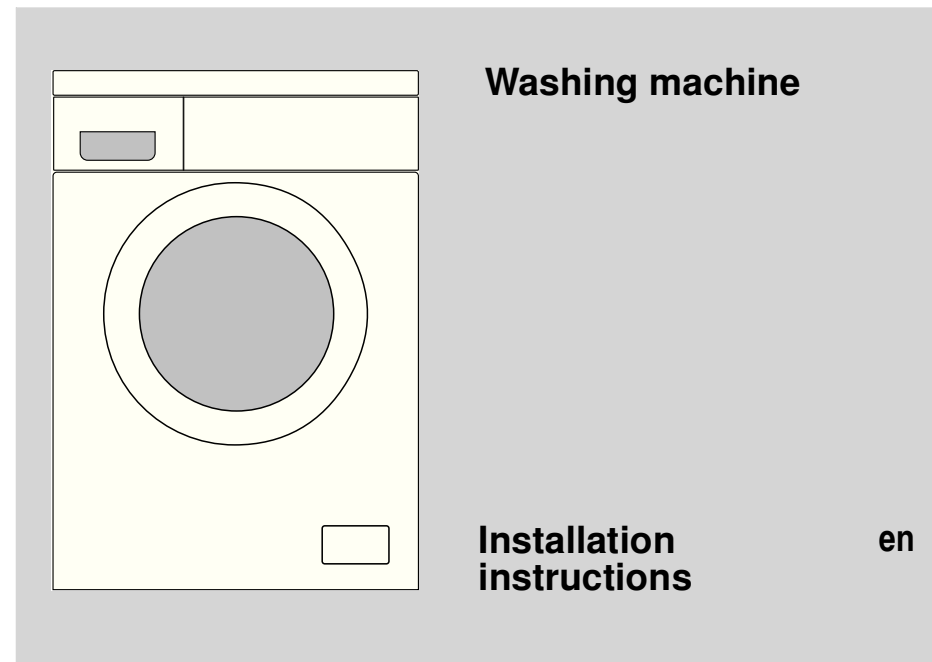

Contents

	<i>Page</i>
■ Safety instructions	1
■ Installation surface	1
■ Installing the appliance	1
■ Scope of delivery	2
■ Hose and cable lengths	2
■ Removing the transport braces	3
■ Water connection	3/4
■ Alignment	5
■ Electrical connection	5
■ Transportation, e.g. when moving home	6
■ Technical specifications	6
■ After-sales service	7
■ Aqua-Stop warranty	7



Read these instructions before switching on the washing machine. Also observe the separate Instruction manual. Keep all documents for use in the future or for the subsequent owner.