

9000 406 612 (8812)

en Instructions for use

**SIEMENS**

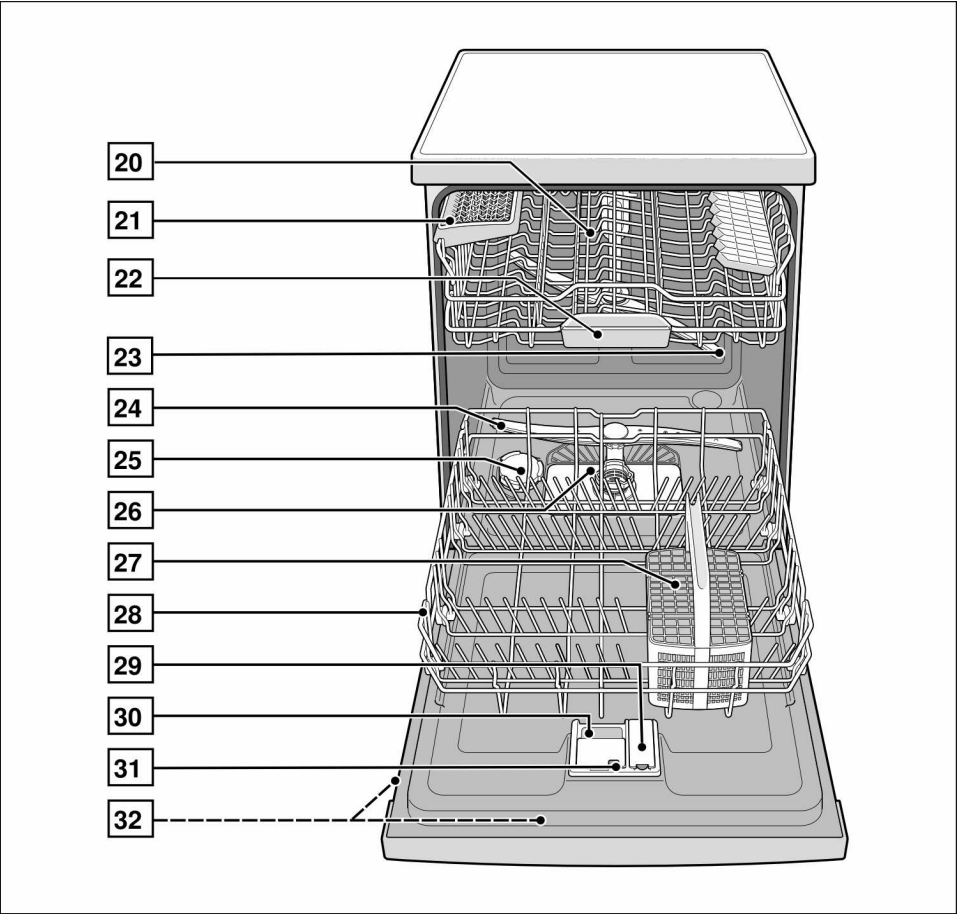
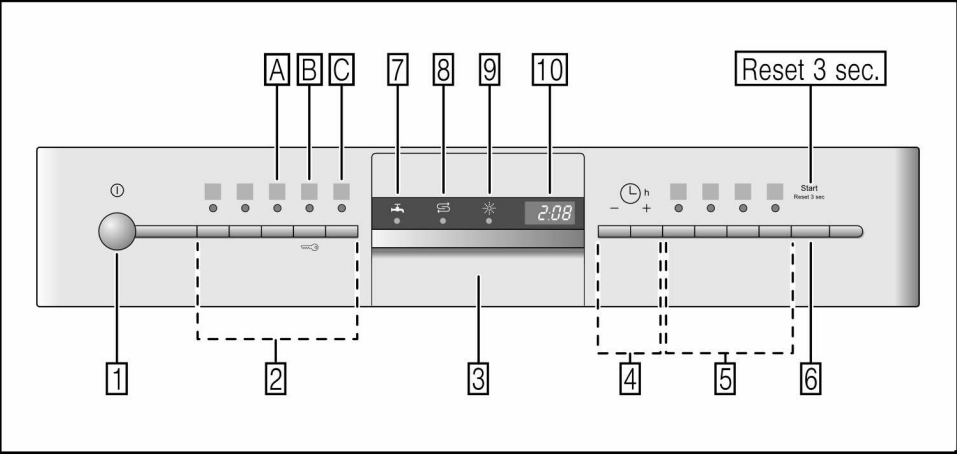

# en Index

<b>Safety instructions</b> .....	<b>4</b>	IntensiveZone .....	15
Delivery .....	4	Extra drying .....	15
Installation .....	4	<b>Washing the dishes</b> .....	<b>15</b>
In daily use .....	4	Programme data .....	15
Children in the household ....	4	Aqua sensor .....	15
Childproof lock (door lock) ....	4	Switching on the appliance ...	15
Childproof lock (button lock) ..	5	Remaining running time display	16
Damage .....	5	Timer programming .....	16
Disposal .....	5	End of programme .....	16
<b>Getting to know your appliance</b>	<b>5</b>	Switching off the appliance ...	16
Control panel .....	5	Interrupting the programme ...	16
Appliance interior .....	5	Terminating the programme (Reset)	16
<b>Water softening system</b> ...	<b>6</b>	Changing the programme ....	17
Set .....	6	Intensive drying .....	17
<b>Salt</b> .....	<b>7</b>	<b>Maintenance and care</b> ....	<b>17</b>
Using salt .....	7	Overall condition of the machine	17
Switching off salt refill indicator/ water softening system .....	7	Filters .....	18
<b>Rinse aid</b> .....	<b>8</b>	Spray arms .....	18
Setting amount of rinse-aid ...	8	Waste water pump .....	19
Switching off rinse-aid refill indicator	8	<b>Troubleshooting</b> .....	<b>19</b>
<b>Utensils</b> .....	<b>9</b>	... when the appliance is switched on	19
Not suitable .....	9	... on the appliance .....	19
Glass and utensil damage ....	9	... changing settings .....	20
Loading the dishwasher .....	9	... during the wash cycle .....	20
Unloading the dishwasher ....	9	... on the utensils .....	21
Cups and glasses .....	9	<b>Customer service</b> .....	<b>22</b>
Pans .....	10	<b>Installation</b> .....	<b>22</b>
Cutlery basket .....	10	Safety instructions .....	22
Folding spikes .....	10	Delivery .....	23
Small accessories holder .....	10	Installation .....	23
Knife shelf .....	11	Waste-water connection .....	23
Adjusting the height of the basket	11	Fresh-water connection .....	23
<b>Detergent</b> .....	<b>12</b>	Electrical connection .....	24
Adding detergent .....	13	Removing the appliance .....	24
<b>Overview of programmes</b> ..	<b>14</b>	Transportation .....	24
Programme selection .....	14	Protection against frost .....	24
Information about comparability tests	14	<b>Waste disposal</b> .....	<b>25</b>
<b>Additional options</b> .....	<b>15</b>	Packaging .....	25
Eco Option .....	15	Old appliances .....	25
Half load .....	15		
Hygiene .....	15		

## Safety instructions

### Delivery

- Check the packaging and dishwasher immediately for damage caused in transit. Do not switch on a damaged appliance, but contact your supplier.
- Please dispose of the packaging material in an environmentally friendly manner.
- Do not let children play with packaging and its parts. There is a risk of suffocation from collapsible boxes and film.

### Installation

Read the “Installation” chapter to learn how to install and connect the appliance correctly.

### In daily use

- Use the dishwasher only in the household and only for its designed purpose, i.e. for washing domestic dishes.
- Do not lean or sit on the open door. The appliance could tip.
- Please note that free-standing appliances may tip over if the baskets are overloaded.
- Do not add any solvents to the washing chamber. Danger of explosion!
- Open the door carefully when the programme is still running. There is a risk of hot water spraying out of the appliance.
- To prevent injuries, e.g. caused by stumbling, open the dishwasher only briefly in order to load and unload the dishwasher.
- Read and observe the safety information and instructions for use on the packaging for cleaning and rinsing agents.



### Warning

Knives and other utensils with sharp points must be placed in the cutlery basket with the points downwards or horizontally on the knife shelf \*.

\* depending on model

### Children in the household

- If fitted, use the childproof lock. An exact description can be found in the back of the envelope.
- Do not allow children to play with or operate the appliance.
- Keep children away from detergents and rinse aid. These may cause chemical burns in the mouth, throat and eyes or asphyxiation.
- Keep children away from open dishwasher. The water in the rinsing compartment is not drinking water and could contain detergent residue. Ensure that children do not place fingers in the tablet collecting tray 22. Small fingers could become caught in the slots.
- If the appliance is installed at eye-level, ensure when opening and closing the door that children are not caught or crushed between the appliance door and the cupboard door situated below.

### Childproof lock (door lock)

The description of the childproof lock is at the back in the envelope.

## Childproof lock (button lock)

You can secure your appliance to prevent unintentional cancellation of the programme (e.g. incorrect operation by children).

### Activating the button lock:

- Start the required programme.
- Hold down the button **[B]** for approx. 4 sec. until this **[L]** is indicated on the digital display.

If any button is pressed while the programme is running, this **[L]** is indicated on the digital display. It is not possible to end (reset) the programme.

### Deactivating the button lock:

- Hold down the button **[B]** for approx. 4 sec. until the display **[L]** goes out.

When the programme ends (0:00 on the digital display), the button lock is cancelled. If there is a power failure, the button lock is retained. Whenever a programme is restarted, the button lock must be reactivated.

## Damage

- The appliance may be repaired and opened up by a technician only. To do this, disconnect the appliance from the power supply. Pull out the mains plug or switch off the fuse. Turn off the tap.

## Disposal

- Make redundant appliances unusable to prevent subsequent accidents.
- Dispose of the appliance in an environmentally friendly manner.



### Warning

Children could become locked in the appliance (risk of suffocation) or find themselves in other dangerous situations. Therefore: Pull out the mains plug, sever and dispose of the power cord. Destroy the door lock so that the door can no longer be closed.

## Getting to know your appliance

Diagrams of the control panel and the interior of the appliance can be found in the envelope at the front.

Individual positions are referred to in the text.

### Control panel

- 1 ON/OFF switch
- 2 Programme buttons \*\*
- 3 Door Opener
- 4 Timer programming \*
- 5 Additional options \*\*
- 6 START button
- 7 Display "Check water supply"
- 8 Salt refill indicator
- 9 Rinse-aid refill indicator
- 10 Digital display

\* depending on model

\*\* Number depending on model

### Appliance interior

- 20 Top basket
- 21 Knife shelf \*
- 22 Tablet collecting tray
- 23 Top spray arm
- 24 Bottom spray arm
- 25 Dispenser for salt
- 26 Filters
- 27 Cutlery basket
- 28 Bottom basket
- 29 Dispenser for rinse aid
- 30 Detergent dispenser
- 31 Lock for detergent dispenser
- 32 Rating plate

\* depending on model

## Water softening system

To ensure good washing results, the dishwasher requires soft water, i.e. containing low amounts of lime, otherwise white limescale will be deposited on the utensils and inner container.

Tap water above 7° dH (from set value *H:01*) must be softened.

The water is softened with salt (regeneration salt) in the water softening system of the dishwasher.

The setting and therefore the required amount of salt depends on the degree of hardness of your tap water (see table).

### Set

The amount of salt dispensed can be set from *H:00* to *H:07*.

Sal is not required at the set value *H:00*.

- Find out about the hardness value of your tap water. Your water supply company will assist you.
- Set value can be found in the water hardness table.
- Close the door.
- Switch on ON/OFF switch  1.
- Hold down programme button  A and press START button  6 until on the digital display is indicated *H:0...*
- Release both buttons.  
The LED for button  A flashes and the digital display displays the factory setting *H:04*.

To change the setting,

- press programme button  C.  
Each time the button is pressed, the set value increases by one level; when the value of *H:07* has been reached, the display jumps back to *H:00* (off).
- Press START button  6.  
The chosen setting has now been stored.

## Water hardness table

Water hardness value °Clarke	Hardness range	mmol/l	Set value on the machine
0–8	soft	0–1.1	<i>H:00</i>
9–10	soft	1.2–1.4	<i>H:01</i>
11–12	medium	1.5–1.8	<i>H:02</i>
13–15	medium	1.9–2.1	<i>H:03</i>
16–20	medium	2.2–2.9	<i>H:04</i>
21–26	hard	3.0–3.7	<i>H:05</i>
27–38	hard	3.8–5.4	<i>H:06</i>
39–62	hard	5.5–8.9	<i>H:07</i>

## Salt

### Using salt

Always refill with salt immediately before switching on the appliance. This ensures that overrun salt solution is immediately washed out and does not corrode the rinsing tank.

- Open the screw-type cap of the compartment **25**.
- Fill the tank with water (only required when switching on the appliance for the first time).
- Then add dishwasher salt (**not table salt or tablets**).

The water is displaced and runs out.

As soon as the salt refill indicator **8** on the fascia is lit, top up the salt.

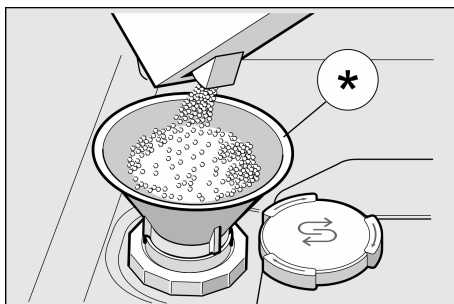

\* depending on model

### Using detergents with salt component

If combined detergents with a salt component are used, salt can usually be omitted up to a water hardness of 21° dH (37° fH, 26° Clarke, 3.7 mmol/l). If the water hardness is over 21° dH, salt must be used.

### Switching off salt refill indicator/water softening system

If the salt refill indicator **8** is impaired (e.g. when using combined detergents containing salt component), it can be switched off.

- Proceed as described under “Setting water softening system” and set the value to **H:00**.  
The water softening system and salt refill indicator are now switched off.



#### Warnings

- Never fill the salt dispenser with detergent. You will destroy the water softening system.
- To prevent corrosion, always refill with salt immediately before switching on the appliance.

## Rinse aid

As soon as the rinse-aid refill indicator **9** lights up on the control panel, refill with rinse aid.

The rinse aid is required for stain-free utensils and clear glasses.

Use only rinse aid for domestic dishwashers.

Combined detergents with rinse-aid component may be used up to a water hardness of 21 °dH (37 °fH, 26 °Clarke, 3,7 mmol/l) only. If the water hardness is over 21 °dH, rinse-aid must be used.

- Open the dispenser **29** by pressing and lifting the plate on the cover.

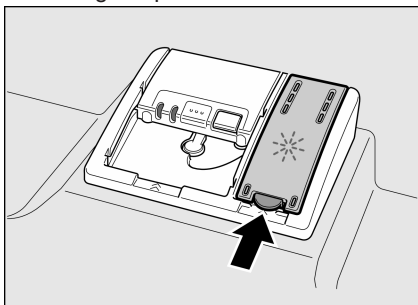

- Carefully pour rinse aid up to the max. mark in the filler opening.

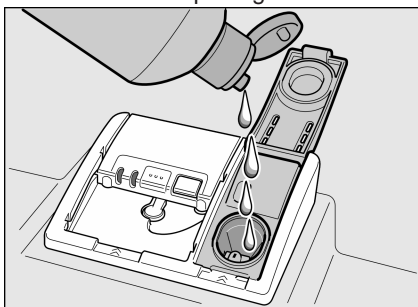

- Close cover until it clicks shut.
- To prevent excessive foam formation during the next rinse cycle, remove any rinse aid which has run over with a cloth.

## Setting amount of rinse-aid

The amount of rinse-aid dispensed can be set from  $r:00$  to  $r:05$ . The factory setting is  $r:05$ .

Do not change the amount of rinse-aid unless streaks (select lower setting) or water stains (select higher setting) are left on the utensils.

- Close the door.
- Switch on ON/OFF switch **1**.
- Hold down programme button **A** and press START button **6** until on the digital display is indicated  $H:0...$ .
- Release both buttons.  
The LED for button **A** flashes and the digital display displays the factory setting  $H:04$ .

- Press programme button **A** until the factory set value  $r:05$  is indicated on the digital display **10**.

To change the setting,

- press programme button **C**.  
Each time the button is pressed, the set value increases by one level; when the value of  $r:05$  has been reached, the display jumps back to  $r:00$  (off).
- Press START button **6**.  
The set value is saved.

## Switching off rinse-aid refill indicator

If the rinse-aid refill indicator **9** is impaired (e.g. when using combined detergents containing rinse-aid component), it can be switched off.

- Proceed as described under “Setting amount of rinse-aid” and set the value to  $r:00$ .

The rinse-aid refill indicator **9** is now switched off.

## Utensils

### Not suitable

- Cutlery and utensils made of wood.
- Delicate decorative glasses, craft and antique utensils. These decors are not dishwasher-proof.
- Plastic parts not resistant to heat.
- Copper and tin utensils.
- Utensils which are soiled with ash, wax, lubricating grease or ink.

Aluminium and silver parts have a tendency to discolour and fade during the wash cycle. Even some types of glass (e.g. crystal glass objects) may turn cloudy after many wash cycles.

### Glass and utensil damage

#### Causes:

- Glass type and glass production process.
- Chemical composition of the detergent.
- Water temperature of the wash programme.

#### Recommendation:

- Use only glasses and porcelain which the manufacturer designates as dishwasher-proof.
- Use a detergent which protects utensils.
- Take glass and cutlery out of the dishwasher as soon as possible after the programme ends.

### Loading the dishwasher

- Remove large food remnants.  
It is not necessary to prerinse utensils under running water.
- Place the utensils so that
  - they are secure and cannot tip over.
  - all utensils with their openings face down.
  - parts with curves or indentations are at an angle, thereby allowing water to drain.
  - does not obstruct rotation of the two spray arms 23 and 24.

Very small utensils should not be washed in the machine, as they may fall out of the baskets.

### Unloading the dishwasher

To prevent water from dripping off the upper basket onto the utensils in the lower basket, it is recommended to empty the appliance from the bottom up.

### Cups and glasses

Top basket 20



\* depending on model

## Pans

Bottom basket 28



## Cutlery basket

You should always place cutlery unsorted with the points downwards.

To prevent injuries, place long, pointed implements and knives on the knife shelf.

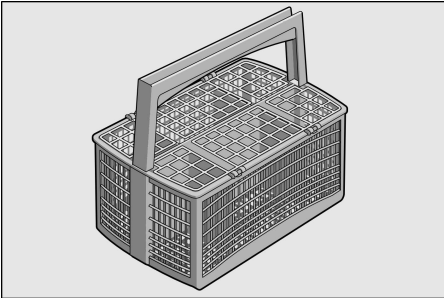

## Folding spikes \*

\* depending on model

The spikes can be folded down to improve arrangement of pans, bowls and glasses.

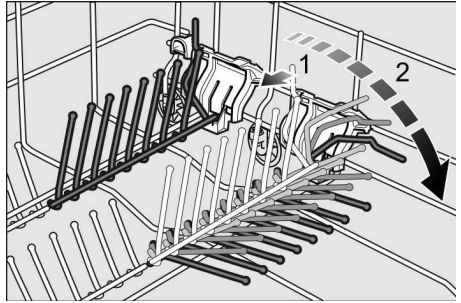

## Small accessories holder \*

\* depending on model

Light-weight plastic accessories, e.g. cups, lids, etc. can be held securely in the small accessories holder.

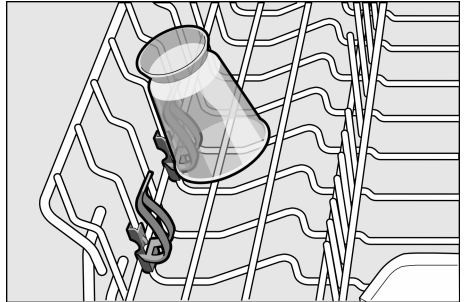

## Knife shelf \*

\* depending on model

Long knives and other utensils can be arranged horizontally.

You can remove the knife shelf to wash taller utensils. Re-insert the knife shelf in the correct position.

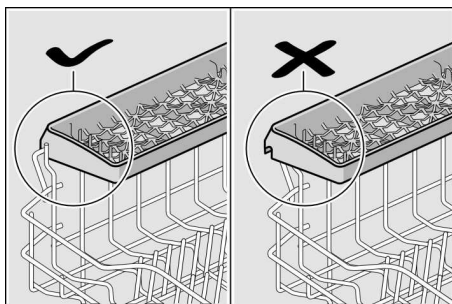

## Adjusting the height of the basket \*

\* depending on model

If required, the height of the upper utensils basket can be adjusted to provide more space for tall utensils either in the upper or lower basket.

### Appliance height 81.5 cm

	Top basket	Bottom basket
Setting 1 max. Ø	22 cm	30 cm
Setting 2 max. Ø	24.5 cm	27.5 cm
Setting 3 max. Ø	27 cm	25 cm

### Appliance height 86.5 cm

	Top basket	Bottom basket
Setting 1 max. Ø	24 cm	33 cm
Setting 2 max. Ø	26.5 cm	30.5 cm
Setting 3 max. Ø	29 cm	28 cm

Select one of the two following procedures according to the design of the top basket for your appliance model:

### Top basket with side levers (Rackmatic)

- Pull out the top basket  20 .
- To **lower** the basket, press in the left and then the right lever on the outside of the basket. In doing so, hold the sides of the basket along the upper edge to prevent it from suddenly dropping.

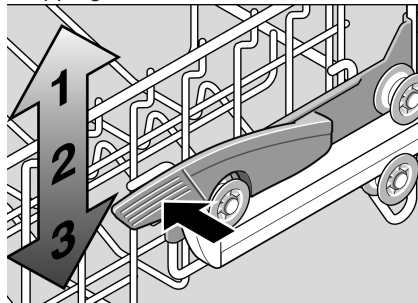

- To **raise** the basket, hold the basket on the sides of the upper edge and lift it up.
- Before re-inserting the basket again, ensure that it is at the same height on both sides. Otherwise, the appliance door cannot be closed and the upper spray arm will not be connected to the water circuit.

### Top basket with upper and lower roller pairs

- Pull out the top basket.
- Remove the upper basket and re-attach it to the upper (stage 3) or lower (stage 1) rollers.

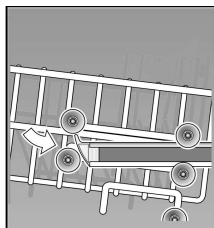
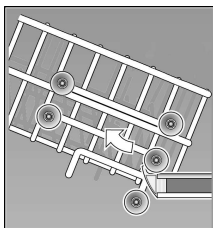

## Detergent

You can use tablets as well as powder or liquid detergents for dishwashers, but never use washing up liquid. Tablets contain not only detergent but also rinse-aid and salt (3in1) and, depending on the combination (4in1, 5in1, etc.), additional components such as glass protection or stainless steel cleaner. If tablets contain rinse-aid and salt, it is usually not necessary to add additional rinse-aid and salt up to a specific degree of hardness. If the degree of hardness is higher and if using solo detergents (powder or liquid detergents or tablets without rinse-aid and salt) rinse-aid and salt must be added. The appliance doses these automatically according to the preset values for water hardness and amount of rinse-aid.

**As soon as combined detergent products are used, the rinse programme is adjusted automatically to ensure the best possible rinsing and drying result.**

### Tip

Follow the instructions for use or the instructions on the detergent packaging to ensure that rinse-aid and salt are used effectively.

If you have further questions, we recommend that you contact the detergent manufacturers' helpline.

### Detergent dispenser with dosing aid

The graduated detergent dispenser 30 helps you add the correct amount of powder or liquid detergent:

lower line:	15 ml
middle line:	25 ml
full:	50 ml

## Adding detergent

- Pour detergent into the dispenser [30] (insert tablet flat, not on its edge). Dosage: see manufacturer's instructions on the packaging.
- Close the cover on the detergent dispenser by sliding it up until the lock engages without difficulty.

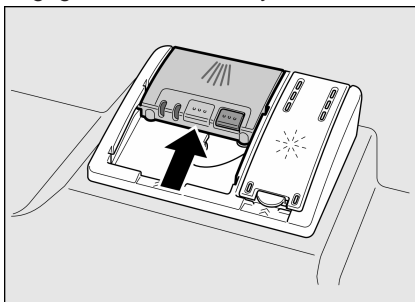

The detergent dispenser opens automatically at the optimum time depending on the programme. The powder or liquid detergent is distributed in the appliance and is dissolved, the tablet falls into the tablet collecting tray where it dissolves in doses.

### Tip

If the utensils are only lightly soiled, slightly less than the indicated amount of detergent is usually adequate.



### Warnings





- Do **not** place small parts for washing in the tablet collecting tray [22]; this prevents the tablet from dissolving evenly.
- If you want to add more utensils after the programme has started, do **not** use the tablet collecting tray [22] as a handle for the upper basket. The tablet could already be there and you will touch the partially dissolved tablet.

### Note

- You will obtain optimum rinsing and drying results by using solo detergents and applying salt and rinse-aid separately.
- If programmes are short, tablets may not have full cleaning effect due to different dissolving properties and there may even be undissolved detergent residue. It is recommended to use washing powder for these programmes.
- The Intensive programme (on some models) requires one tab only. When using washing powder, you can apply some of this cleaning agent to the inside of the appliance's door.
- Even if the rinse-aid and/or salt refill indicator is lit, the rinse programme will run correctly if combined detergents are used (when using combined detergents, add rinse-aid at a water hardness above 21 °dH – see chapter entitled "Rinse-aid").
- If you switch from combined detergents to solo detergents, ensure that the water softening system and amount of rinse-aid have been set to the correct value.
- If using detergents in a water-soluble protective cover: Take hold of the cover with dry hands only and put the detergent into an absolutely dry detergent dispenser only, otherwise the detergent may stick.

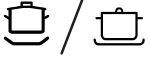
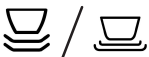
## Overview of programmes

The max. possible number of programmes is illustrated in this overview. The corresponding programmes for your appliance can be found on the fascia.

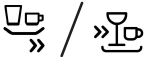
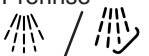
Programme	Type of utensils and soiling	Programme sequence	Possible additional options
Intensive 70° 	Pots, utensils and cutlery Highly soiled	Prerinse Clean 70° Intermediate rinse Final rinse 70° Dry	all
Normal 65° 	Utensils and cutlery Normally soiled	Prerinse Clean 65° Intermediate rinse Final rinse 65° Dry	all
Auto 45°–65° auto 	Utensils and cutlery Normally soiled	Is optimised according to the soiling with the aid of sensors.	all
Eco 50°  / <b>eco</b>	Utensils and cutlery Normally soiled	Prerinse Clean 50° Intermediate rinse Final rinse 65° Dry	all
Gentle 40° 	Utensils and cutlery Lightly soiled	Prerinse Clean 40° Intermediate rinse Final rinse 55° Dry	IntensiveZone Eco Option Half load Extra drying
Quick 45° 	Utensils and cutlery Lightly soiled	Clean 45° Intermediate rinse Final rinse 55°	Extra drying
Prerinse 	Lightly soiled	Prerinse	none

### Programme selection

You can select a suitable programme according to the type of utensils and degree of soiling.

### Information about comparability tests

The conditions for running comparability tests can be found on the supplementary sheet "Information for comparability tests".

## Additional options

\* depending on model

Additional options  can be set with the buttons.

### Eco Option \*

Water and energy consumption can be reduced with the “Eco Option” function. The running time is extended for optimum washing and drying results.



### Half load \*

If you have only a few items to wash (e.g. glasses, cups, plates), you can switch to “half load”. This will save water, energy and time. It is recommended to put a little less detergent in the detergent dispenser than for a full load.



### Hygiene \*

The temperature is increased during the rinsing process. This increases the hygiene status. This additional option is ideal for cleaning e.g. chopping boards and baby bottles.



### IntensiveZone \*

Perfect for a mixed load. You can wash very soiled pots and pans in the lower basket together with normally soiled utensils in the upper basket. The spray pressure in the lower basket is intensified, the rinsing temperature is increased slightly.



### Extra drying \*

An increased temperature during the final rinse and an extended drying phase mean that even plastic parts dry well. There is a slight increase in the energy consumption.

## Washing the dishes

### Programme data

The programme data (consumption values) can be found in the summary of instructions. They refer to normal conditions and the water hardness set value  $H:04$ . Different influencing factors such as water temperature or line pressure may result in deviations.





### Aqua sensor \*

\* depending on model

The Aqua sensor is an optical measuring device (light barrier) which measures the turbidity of the rinsing water.

The Aqua sensor is used according to the programme. If the Aqua sensor is active, “clean” rinsing water can be transferred to the next rinse bath and water consumption can be reduced by 3–6 litres. If the turbidity is greater, the water is drained and is replaced with fresh water. In the automatic programmes the temperature and running time can also be adjusted to the degree of soiling.

### Switching on the appliance

- Turn on the tap fully.
- Close the door.
- Switch on ON/OFF switch .
- The display of the last selected programme flashes. This programme remains selected if no other programme button  is pressed.
- The expected programme duration flashes on the digital display .
- Press the START button .
- The programme starts running.

## Remaining running time display

When the programme is selected, the remaining running time of the programme is indicated on the digital display .

The running time is determined during the programme by the water temperature, the number of utensils as well as the degree of soiling and may vary (depending on the selected programme).

## Timer programming \*

\* depending on model

You can delay the start of the programme in 1-hour steps up to 24 hours.

- Close the door.
- Switch on ON/OFF switch .
- Press  + button until the digital display  jumps to *h:00 l*.
- Press  + or – button until the displayed time corresponds with your requirements.
- Press START button , timer programming is activated.
- To delete timer programming, press the  + or – button until *h:00* is indicated on the digital display.  
You can change your programme selection at any time until the programme starts.

## End of programme

The programme has ended when the value *0:00* is indicated on the numerical display .

## Switching off the appliance

Short time after the end of the programme:

- Switch off ON/OFF switch .
- Turn off the tap (not applicable if Aqua-Stop fitted).
- Remove the utensils when they have cooled down.



## Warning

At the end of the programme please open the door fully and not partially when emptying the dishwasher. Any escaping water vapour could damage sensitive worktops.

## Interrupting the programme

- Switch off ON/OFF switch .
- The LEDs go out. The programme is saved.  
If the door was opened on an appliance which has a warm water connection or is heated, first leave the door ajar for several minutes and then close. Otherwise, expansion (pressure) may cause the appliance door to spring open or water to run out of the appliance.
- To continue the programme, switch on the ON/OFF switch  again.

## Terminating the programme (Reset)

- Press START button  for approx. 3 sec.  
The numerical display  indicates *0:00 l*.  
The programme sequence lasts approx. 1 min.  
On the digital display  is indicated *0:00*.
- Switch off ON/OFF switch .

## Changing the programme

When the START button  has been pressed, the programme cannot be changed.







The only way a programme can be changed is by Cancel programme (reset).

## Intensive drying



The final rinse uses a higher temperature which improves the drying result.

The running time may increase slightly.

(Caution if utensils are delicate!)

- Close the door.
- Switch on ON/OFF switch .
- Hold down programme button  and press START button  until on the digital display  is indicated *H:0...*
- Release both buttons.  
The LED for button  flashes and the digital display displays the factory setting *H:04*.
- Press programme button  until the factory set value *d:00* is indicated on the digital display .

To change the setting,

- Press the button  to switch intensive drying on *d:01* or off *d:00*.
- Press START button .  
The set value is saved.

## Maintenance and care

A regular inspection and maintenance of your machine will help to prevent faults. This saves time and prevents problems.

## Overall condition of the machine

- Check spray arm for grease and limescale deposits.

If you find such deposits:

- Fill detergent dispenser with detergent. Start the appliance without utensils in the programme with the highest rinsing temperature.

Clean the appliance with detergents/ appliance cleaners which are particularly suitable for use with dishwashers.

- Regularly clean door seal with a damp cloth.

Never use a steam cleaner to clean your dishwasher. The manufacturer is not liable for any consequential damage.

Regularly wipe the front of the appliance and fascia with a damp cloth; water and a little washing up liquid are adequate. Do not use sponges with a rough surface or abrasive detergents, as these could scratch the surfaces.



Stainless steel appliances: To prevent corrosion, avoid using sponge cloths or wash them out thoroughly several times before using for the first time.



### Warning

Never use other chlorinated household detergents! Health hazard!

## Salt and rinse-aid

- Check the refill indicators  and .  
If required, refill salt and/or rinse-aid.

## Filters

The filters [26] keep large foreign objects in the rinsing water away from the pump. These foreign objects may occasionally block the filters.

The filter system consists of a coarse filter, a flat fine filter and a microfilter.

- After each washing cycle check the filters for residue.
- Unscrew filter cylinder as illustrated and take out filter system.

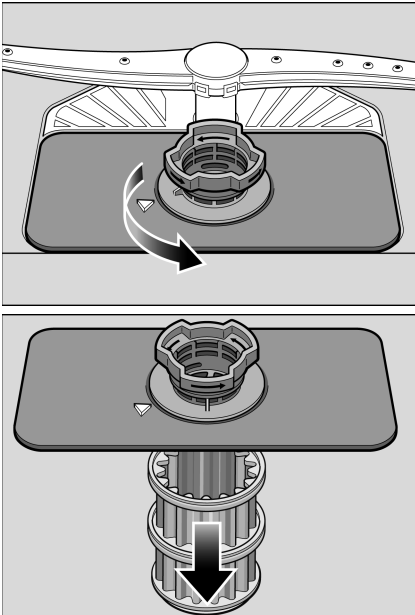

- Remove any residue and clean filters under running water.
- Re-install filter system in reverse sequence and ensure that the arrow marks are opposite each other after closing the filter system.

## Spray arms

Limescale and contaminants in the rinsing water may block nozzles and bearings on the spray arms [23] and [24].

- Check outlet nozzles on the spray arms for blockages.
- Unscrew the upper spray arm [23].
- Remove the lower spray arm [24] upwards.

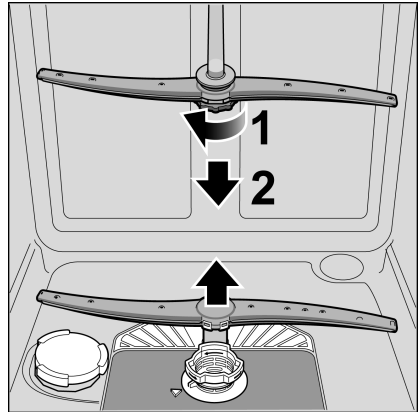

- Clean spray arms under running water.
- Re-engage or screw on spray arms.

## Waste water pump

Large food remnants in the rinsing water not retained by the filters may block the waste water pump. The rinsing water is then not pumped out and covers the filter. In this case:

- First disconnect the appliance from the power supply.
- Remove the filters 26.
- Scoop out water, use a sponge if required.
- Using a spoon, prise off pump cover (as illustrated) until it clicks, then grip the cover by the lug and first pull it upwards until it resists and then pull it out forwards.

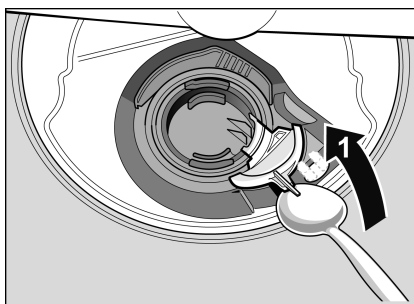

- Check inner compartment and remove any foreign objects.
- Place cover in the original position, press down and engage.

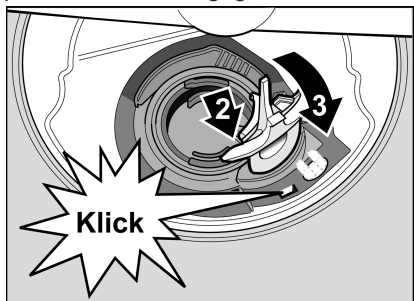

- Install filters.

## Troubleshooting

Experience has shown that you can rectify most faults which occur in daily operation without calling customer service. Obviously this will save on costs and ensure that the machine is quickly available again. The following overview should help you locate the causes of faults which may occur.



### Warning

If an error code (**E:01 to E:30**) is indicated on the digital display 10, always disconnect the appliance from the power supply and then turn off the tap.

You can rectify certain faults yourself (see following fault description), for all other faults please contact customer service and state the indicated fault **E:XX**.



### Warning

Remember: Repairs may be carried out by technicians only. If a component has to be replaced, ensure that only original spare parts are used. Improper repairs or use of non-original spare parts may cause considerable damage and put the user at considerable risk.

### ... when the appliance is switched on

- **The appliance does not start.**
  - The mains fuse has tripped.
  - The appliance plug has not been inserted.
  - The appliance door has not been shut properly.

### ... on the appliance

- **Lower spray arm rotates sluggishly.**
    - Spray arm blocked.
  - **The door is difficult to open. \***
    - Child-proof lock is activated. The deactivation instructions are at the back in the envelope.
- \* depending on model

- **Door cannot be closed.**
  - Door lock has been activated. To reset, close the door with greater force.

**... changing settings**

- **A setting cannot be changed, a programme starts.**
  - Wrong programme button pressed. Terminate the programme (see chapter entitled "Terminating the programme (Reset)") and start all over again.
  - You did not wait until programme ended.

- **Cover on the detergent dispenser cannot be closed.**
  - Detergent dispenser overfilled or mechanism blocked by sticky detergent residue.

- **Detergent residue in the detergent dispenser.**
  - Dispenser was damp when filled.

- **"check water supply" [ 7 ] display lights up.**
  - Tap turned off.
  - Water supply interrupted.
  - Supply hose kinked.
  - Filter in the water supply blocked.
    - Switch off the appliance and pull out the mains plug.
    - Turn off the tap.
    - Clean filter in the supply hose.

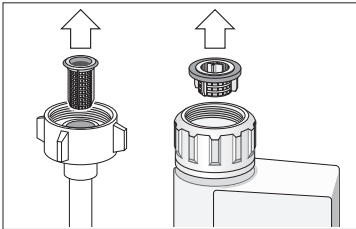

- Reconnect power supply.
- Turn on the tap.
- Switch on the appliance.

- **Water is left in the appliance at the end of the programme.**
  - (E24) Waste water hose is blocked or kinked.
  - (E25) Waste water pump blocked, cover on the waste water pump is not locked in position (see Maintenance and Care).
  - Filters blocked.
  - The programme has not yet ended. Wait until programme ends (digital display indicates 0:00) or implement the "Reset" function.

- **Refill indicator for salt [ 8 ] and/or rinse-aid [ 9 ] is not lit.**
  - Refill indicator/s switched off.
  - Adequate salt/rinse-aid available.
- **Refill indicator for special salt [ 8 ] is lit.**
  - No salt. Refill with salt.
  - Sensor does not detect salt tablets. Use different special salt.

**... during the wash cycle**

- **Unusual foam formation**
  - Handwash liquid in the rinse aid dispenser. Spilled rinse-aid causes excessive frothing, therefore please remove with a cloth.
- **Appliance stops during the wash cycle.**
  - Power supply interrupted.
  - Water supply interrupted.
- **Knocking/rattling noise during rinsing**
  - Spray arm is striking utensils.
  - Utensils not arranged correctly.

- **Filling valves making striking noises**
  - Caused by the installation of the water line and has no effect on the function of the machine. Remedial action is not possible.

### ... on the utensils

- **Food residue on the utensils.**
  - Utensils placed too closely together, utensils basket overfilled.
  - Too little detergent.
  - Rinse programme too weak.
  - Spray arm rotation obstructed.
  - Spray arm nozzles blocked.
  - Filters blocked.
  - Filters incorrectly inserted.
  - Waste water pump blocked.
  - Top basket on right and left not set to same height.
- **Tea or lipstick residue is not completely removed.**
  - Detergent has inadequate bleaching effect.
  - Too low rinsing temperature.
  - Too little/unsuitable detergent
- **White stains on the utensils/glasses remain milky.**

If phosphate-free detergents are used with hard tap water, white deposits may be deposited more easily on utensils and the container walls.

- Too little/unsuitable detergent.
- Too weak programme selected.
- No/too little rinse-aid.
- No/too little salt.
- Water softening system set to the wrong value.
- Salt dispenser lock not fastened.

Contact the detergent manufacturer, in particular if:

- the utensils are very wet at the end of the programme.
- limescale forms.

- **Dull, discoloured glasses, film cannot be washed off.**
  - Unsuitable detergent.
  - Glasses not dishwasher-proof.
- **Streaks on glasses and cutlery, glasses have metallic appearance.**
  - Too much rinse-aid.
- **Plastic parts discoloured.**
  - Too little/unsuitable detergent.
  - Too weak programme selected.
- **Rust spots on the cutlery.**
  - Cutlery not rust-resistant.
  - Salt content in the rinsing water too high, as salt dispenser lock not fastened firmly or salt was spilled while being refilled.
- **Utensils not dry.**
  - Appliance door opened too early and utensils taken out too early.
  - Programme selected without drying.
  - Too little rinse-aid.

## Customer service

If you are unable to rectify the fault, please contact your customer service.

Your nearest customer service centre can be found in the customer service list.

When calling customer service, please quote the appliance number (1) and the FD number (2) which can be found on the rating plate  on the appliance door.

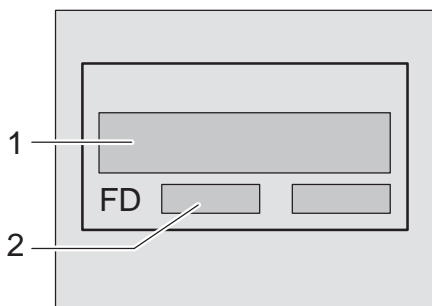

### Warning

Please note that a visit by a customer service technician to repair a malfunction or one of the described faults will not be free of charge **even during the warranty period.**

## Installation

The dishwasher must be connected correctly, otherwise it will not function properly. The specifications for the inlet and outlet as well as the electrical connected loads must correspond with the required criteria as specified in the following paragraphs or in the installation instructions.

Install the appliance in the correct sequence:

- Checking appliance on delivery
- Installing the appliance
- Waste-water connection
- Fresh-water connection
- Electrical connection

### Safety instructions

- Install and connect the appliance according to the installation and assembly instructions.
- Prior to installation, disconnect the dishwasher from the power supply.
- Ensure that the protective conductor system of the domestic supply has been correctly installed.
- The electrical connection conditions must correspond with the specifications on the dishwasher rating plate.
- If the power cord of this appliance is damaged, it must be replaced with a particular power cord.  
To prevent injury, the power cord may be replaced by customer service only.
- If the dishwasher is installed in a high-sided unit, the unit must be secured properly.
- Install built-under or integratable appliances only under continuous worktops which have been screwed to adjacent cupboards to ensure stability.

- Do not install the appliance near heat sources (radiators, heat storage tanks, cookers or other appliances which generate heat) and do not install under a hob.
- After installing the appliance, ensure that the plug is easily accessible.
- Some models:  
The plastic housing on the water connection contains an electric valve, the connecting cables are in the supply hose. Do not cut through this hose, do not immerse the plastic housing in water.



### Warning

If the appliance is not in a cavity and a side panel is accessible, the door hinge area must be covered at the side for reasons of safety (risk of injury). The covers are available as optional accessories from customer service or specialist outlets.

## Delivery

Your dishwasher has been checked thoroughly in the factory to ensure that it is in working order. This may cause small water stains. These will disappear after the first wash cycle.

## Installation

The required installation dimensions can be found in the installation instructions. Level the appliance with the aid of the height-adjustable feet. Ensure that the appliance is situated securely on the floor.

- A built-under or integrated appliance which is installed subsequently as a free-standing appliance must be secured to prevent it from overturning, e.g. by screwing it to the wall or by installing it under a continuous worktop which is screwed to adjacent cupboards.

- The appliance can easily be installed in a fitted kitchen between wooden and plastic walls. If the plug is not freely accessible following installation, an allpole disconnecter with a contact opening of at least 3 mm must be fitted on the installation side to satisfy the relevant safety regulations.

## Waste-water connection

- The required work sequence can be found in the installation instructions. If required, fit a siphon with an drainage connection.
- Connect the waste-water hose to the drainage connection of the siphon with the enclosed parts. Ensure that the drainage hose is not kinked, crushed or twisted and that there is no cover plate in the drainage to prevent the waste water from flowing out!

## Fresh-water connection

- Connect the fresh-water connection to the tap according to the installation instructions with the enclosed parts. Ensure that the fresh-water connection is not kinked, crushed or twisted.
- When replacing the appliance, always use a new water supply hose.

### Water pressure:

at least 0.05 MPa (0.5 bar), maximum 1 MPa (10 bar). At a higher water pressure: connect pressure-reducing valve ahead.



### Inlet rate:

minimum 10 litres/minute

### Water temperature:

cold water preferred; hot water max. temp. 60 °C.

## Electrical connection







- Connect the appliance to an alternating current only, ranging from 220 V to 240 V and 50 Hz or 60 Hz via a correctly installed socket with protective earth conductor. See rating plate for required fusing .
- The socket must be near the appliance and freely accessible following installation.
- The connection may be modified by technicians only.
- A power cord extension may be purchased from customer service only.
- Use only a residual-current-operated circuit-breaker which features the  symbol. Only this extension guarantees compliance with the currently valid regulations.
- The appliance features a water damage protection system. Please note the system will function **only** when the power supply is connected.

## Removing the appliance

Also observe the sequence of worksteps here.

- Disconnect the appliance from the power supply.
- Turn off the water supply.
- Disconnect the waste water and fresh water connections.
- Loosen the fastening screws under the worktop.
- If fitted, remove the base panel.
- Pull out the appliance, carefully pulling the hose behind.

## Transportation

- Empty the dishwasher and secure loose parts.  
Drain the appliance according to the following steps:
  - Turn on the tap.
  - Close the door.
  - Switch on ON/OFF switch . The displays of the last selected programme light up.
  - Select programme with the highest temperature.  
The expected programme duration is indicated on the numerical display .
  - Press START button . Programme sequence starts.
  - After approx. 4 minutes press the START button  until  is indicated on the digital display. After approx. 1 min.  is indicated on the digital display.
  - Switch the appliance off  and turn the tap off.
- Transport appliance upright only. (This prevents residual water from running into the machine control and damaging the programme sequence).

## Protection against frost

If the appliance is in a room where there is a risk of frost (e.g. holiday home), empty the appliance completely (see Transportation).

- Turn off the tap, disconnect supply hose and drain water.

## Waste disposal

Both the packaging of new appliances and the old appliances themselves contain valuable raw materials and recyclable materials.

Please dispose of the individual parts separated according to type.

Please ask your dealer or inquire at your local authority about current means of disposal.

### Packaging

All plastic parts of the appliance are identified with internationally standardised abbreviations (e.g. >PS< polystyrene).

Therefore, plastic waste can be sorted out when the appliance is being disposed of.

Please follow the safety instructions under “Delivery of your appliance”.

### Old appliances

Please follow the safety instructions under “Disposal of your appliance”.



■ This appliance is identified according to the European guideline 2002/96/EC on waste electrical and electronic equipment – WEEE. The guideline specifies the framework for an EU-wide valid return and re-use of old appliances.



### Child-proof lock \*

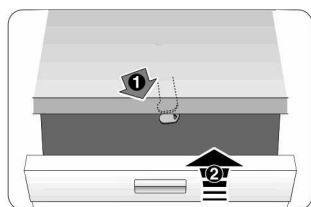

40

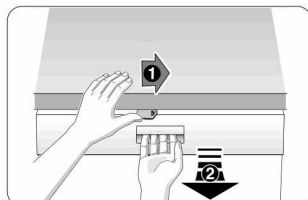

41

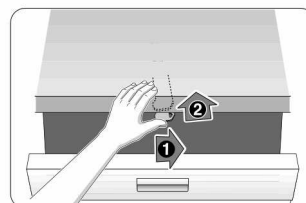

42

- 40 Switch on the child-proof lock
- 41 Open the door with child-proof lock switched on
- 42 Switch off the child-proof lock

Always close the appliance door completely before leaving the appliance. Only in this way can you protect your children from potential hazards.

### Baking sheet spray head \*

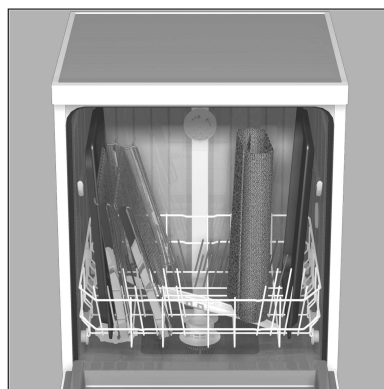
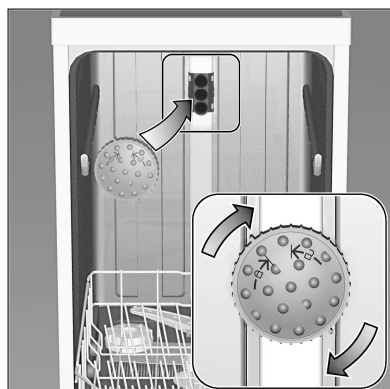

Large sheets or grilles and plates which have a diameter greater than 30 cm (gourmet plates, pasta plates, dinner plates) can be cleaned with the aid of the spray head.

To do this, remove the top basket and insert the spray head as illustrated in the diagram.

To ensure that the spray jet can reach all parts, arrange the baking sheets as illustrated (max. 4 baking sheets and 2 grilles).

Never operate the dishwasher without the top basket or baking sheet spray head!

\* some models

### **AQUA-STOP guarantee**

(does not apply to appliances without Aqua-Stop)

In addition to warranty claims against the seller based on the purchase contract and in addition to our appliance warranty we will pay damages under the following conditions:

1. If our Aqua-Stop system is defective and causes water damage, we will make good the damage for private users. To ensure water damage protection, the appliance **must** be connected to the power supply.
2. This liability guarantee is valid for the service life of the appliance.
3. A prerequisite for the warranty claim is that the appliance has been correctly installed and connected with Aqua-Stop according to our instructions. This also includes the correct installation of the Aqua-Stop extension (original accessory). Our warranty does not extend to defective feed lines or fittings up to the Aqua-Stop connection on the tap.
4. If your appliance is fitted with Aqua-Stop, you can leave your appliance unattended during operation and leave the tap turned on afterwards. The tap should only be turned off if you are absent from home for a prolonged period, e.g. several weeks holiday.

**Siemens-Electrogeräte GmbH**  
**Carl-Wery-Straße 34, 81739 München**

To contact us directly, use the tel. no or fax no. in the enclosed customer service list.

[www.siemens-homeappliances.com](http://www.siemens-homeappliances.com)

9000 406 612 en (8812)  
640MA