

## Operating and Installation Instructions

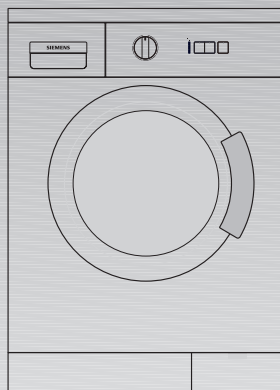

X 08-06

---

# Table of Contents

---

## Operating instructions

Information concerning waste disposal . . . . .	4
Protection of the environment / hints and tips . . .	5
General safety instructions . . . . .	6
Introducing your washing machine . . . . .	7
Before using your washing machine for the first time . . . . .	9
Preparing, sorting and loading the washing . . . .	10
Detergents and cleaning products . . . . .	14
Programmes and functions . . . . .	16
Washing . . . . .	19
When the programme has Ended . . . . .	21
Special applications . . . . .	22
Cleaning and care . . . . .	24
Troubleshooting Minor Faults . . . . .	29
Consumption values . . . . .	32
Customer service . . . . .	33
Installing, connecting and transporting . . . . .	34

---

## Installation instructions

The new washing machine which you have just purchased is a modern, high-quality domestic appliance.

Your washing machine is distinguished by its economical consumption of energy, water and detergent.

Each washing machine which leaves our factory is checked carefully to ensure that it functions properly and is in perfect condition. If you have any questions - especially with respect to installing and connecting your washing machine - please do not hesitate to contact our customer service department.

Further information and a selection of our products can be found on our internet page:  
<http://www.siemens.de/hausgeraete>

Please read these operating and installation instructions and all other information enclosed with the washing machine and act accordingly.

These operating and installation instructions describe various models. Differences are indicated in the appropriate places.

Retain all documentation for subsequent use or for the next owner of the appliance.

---

# Information concerning waste disposal

---

## Disposing of the packaging

The shipping package has protected your new appliance on its way to your home. All utilised materials are ecologically harmless and recyclable. Please contribute to a better environment by disposing of packaging materials in an environmentally conscious manner.

Please ask your dealer or inquire at your local authority about current means of disposal.

### **⚠ Risk of choking!**

Do not let children play with packaging and associated parts. Risk of choking on plastic film and collapsible boxes.

---

## Disposing of your old appliance

Old appliances are not worthless rubbish! Environment-conscious recycling can reclaim valuable raw materials.

### **⚠ Danger of death!**

Unplug mains plug on redundant appliances. Cut off mains cable and discard with mains plug.

Destroy the lock on the door. To prevent playing children from becoming trapped and endangered, ensure that the door locking mechanism is disabled.

---

## Packaging and old appliances

Unpack the appliance and dispose of the packaging in an environmentally-responsible manner.

This appliance is labelled in accordance with European Directive 2002/96/EC concerning used electrical and electronic appliances (waste electrical and electronic equipment - WEEE).

The guideline determines the framework for the return and recycling of used appliances as applicable throughout the EU.



---

# Protection of the environment / hints and tips

Your washing machine uses water, energy and detergent efficiently, thereby protecting the environment and reducing your household costs. See page 32 for consumption values of your appliance.

## Hints and tips

Using your washing machine in an efficient and environmentally friendly manner:

- ❑ Do not exceed maximum load.

Cottons	5,0 kg
Easy-Care	2,5 kg
Delicates/Wool	1,5 kg
Single Wash	3,0 kg

With smaller amounts of laundry, the load adjust reduces the water and energy consumption.

- ❑ Where possible, select the “ **Cottons 60 °C** ” with additional function “**Stains** ☞ ” programme instead of “ **Cottons 90 °C +Prewash** ↵ ”. The longer washing time in this 60 °C programme means that the cleaning effects are comparable with those of a 90 °C programme, although the power consumption is considerably lower.
- ❑ Do not use prewash for lightly to normally soiled washing.
- ❑ Add detergent according to the degree of soiling, amount of laundry and water hardness, and observe the detergent manufacturer’s instructions.

---

# General safety instructions

Your washing machine is intended for

- use in the household only,
- for washing machine-washable fabrics in washing lye,
- operation with cold drinking water and commercially available detergents and cleaning products which are suitable for use in washing machines.

Do not leave children unsupervised near the washing machine.

Keep pets away from the washing machine.

Do not insert/pull out the mains plug with wet hands.

Do not pull out the mains plug by tugging the cable.

Do not touch the loading door when washing at high temperatures.

Caution when draining hot water.

Do not climb onto the washing machine.

Do not lean on the open washing machine door.

# Introducing your washing machine

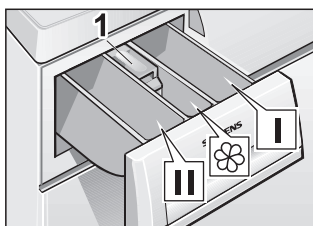

## Adding detergent/cleaning product

Dispenser I:

Detergent for prewash or starch.

Dispenser II:

Detergent for main wash, soaking agent, water softener, bleach or stain remover.

Dispenser :

Additives, e.g. fabric softener or former (do not fill above the lower edge of the insert 1).

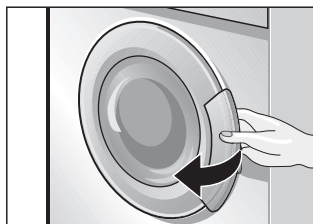

Opening ...

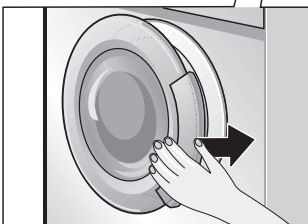

and closing the door

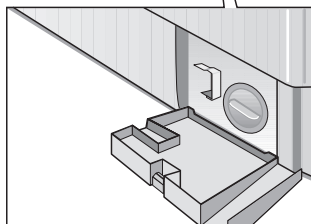

Service flap

# Control panel

## Programme selector

For switching the machine on and off and for selecting the programme.

Can be rotated in either direction.



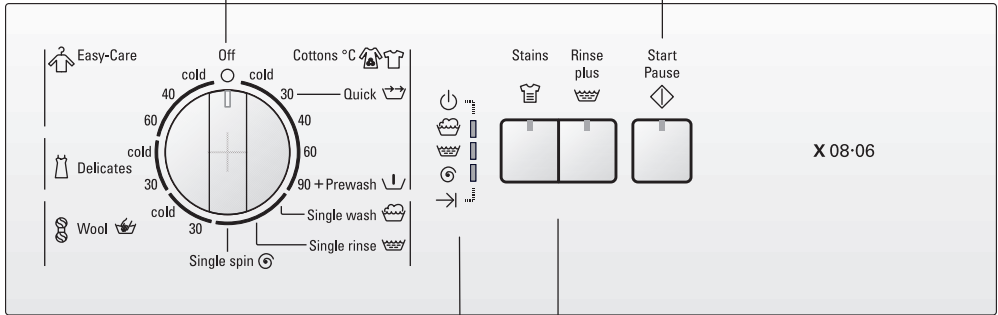

The programme selector does not rotate while the programme is running, the programme sequence is electronically controlled.



## Start Pause button

For starting/pausing the washing cycle (programme must have been selected).

## Indicator lights

, ,  illuminate when the  button is pressed and the particular programme section is running.

 flashes: the programme is selected.

 flashes: the selected programme is finished.

Two indicator lights flash: Operation error.

## Buttons for additional options

(in addition to the programme if required)

Rinse plus : Additional rinse cycle

Stains : Intensive wash cycle

Additional options can be combined before the programme is started.

The indicator lights of the buttons come on, if the additional options are active.

Switching off the additional option: Press the button again. Indicator light goes out.

---







# Before using your washing machine for the first time

---

## Preparing your washing machine

### Attention

The washing machine must have been installed and connected properly (refer to page 34).

- i** The washing machine was tested before leaving the factory. To remove any water left over from testing procedures, the first washing cycle should be carried out **without** laundry in the machine.
- Turn the tap on.
- Pull out the detergent drawer all the way.
- Pour approx. 1 litre of water into chamber **II** of the detergent dispenser.
- Half fill the measuring beaker with detergent and pour into chamber **II**.
- i** Do not use any special detergents for delicates or woollens (excessive foam).
- Close the detergent drawer.
- Close the washing machine door.
- Set the programme selector to **Cottons**  **90 °C +Prewash** . “” indicator light flashes.
- Press the “” button. “” and “” indicator lights are on.  
The programme starts.
- The programme is ended if “” indicator light flashes. Turn the programme selector to **Off**.

---

# Preparing, sorting and loading the washing

---

## Preparing the washing

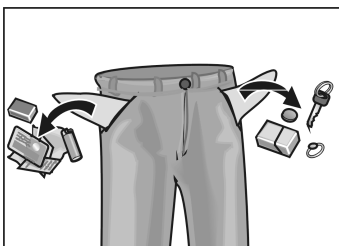

### Warning

Loose debris (e.g. coins, paper clips, needles, nails) can damage items of clothing as well as parts of the washing machine (e.g. drum).

- Empty all pockets on items of clothing.
- Brush sand out of pockets and cuffs/turn-ups.
- Close zips, fasten pillow cases/cushion covers.
- Remove curtain runners or tie up in a net/bag.
- Wash in a net/cushion cover:
  - delicates, e.g. tights, curtains,
  - small laundry items, e.g. socks, handkerchiefs,
  - underwired bras (underwire may become detached during washing and cause damage).
- Trousers, knitwear and knitted textiles, e.g. jersey garments, T-shirts or sweatshirts should be turned inside out.

---

## Sorting the washing

According to colour and degree of dirt

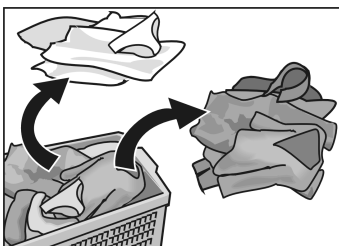

### Warning

Washing may become discoloured. Do not wash new coloured washing with other washing.

White items may become grey. Wash white and coloured items separately.

## Degrees of dirt

### Lightly soiled

No visible soiling or stains. Washing has probably absorbed body odour.

- Light-weight summer clothing and sportswear worn for several hours.
- T-shirts, shirts, blouses worn for up to one day.
- Bed linen, guest towels used for one day.

### Normally soiled

Visible soiling and/or a few light stains.

- T-shirts, shirts, blouses soaked in sweat or worn several times.
- Underpants, briefs worn for one day.
- Tea towels, hand towels, bed linen used for up to one week.
- Curtains (without nicotine soiling) used for up to six months.

### Very soiled

Visible soiling and/or stains.

- Kitchen towels used for up to one week.
- Fabric serviettes.
- Baby bibs.
- Children's outer clothing or football jerseys and shorts soiled with grass and/or earth.
- Work clothes, e.g. mechanic's overalls, baker's and butcher's clothing.

### Typical stains

- Skin grease, cooking oil/fat, sauces, mineral oil, wax (containing fat/oil).
- Tea, coffee, red wine, fruit, vegetables (which can be bleached).
- Blood, egg, milk, starch (containing protein, carbohydrate).
- Soot, earth, sand (pigments), tennis clothing soiled with red clay.

## Removing stains

Remove/pretreat stains as soon as possible after they have occurred.

First dab with a soapy solution. Do not rub.

Then select the appropriate programme and wash the item.

Stubborn/dried in stains can sometimes only be removed by washing several times.

## Sorting washing according to the instructions on the care labels

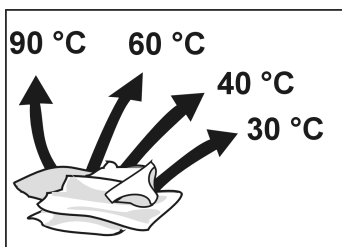

hard-wearing textiles, heat-resistant textiles  
e.g. made from cotton or linen



for easy-care textiles  
e.g. cotton, linen, synthetic materials or blended fabrics



for easy-care, washable textiles  
e.g. silk, satin, synthetic materials or blended fabrics  
(e.g. curtains)



for hand and machine washable wool or wool-rich textiles  
e.g. cashmere, mohair or angora,  
also suited for hand washable silk.

Do not wash laundry items which bear the following care label in the washing machine:

 = do not wash

## Loading the washing

### ⚠ Risk of explosion!

Items of clothing that have been pretreated with solvent-based cleaning agents, e.g. stain remover and dry cleaning spirit, represent an explosion hazard once loaded into the washing machine. Before loading the laundry, rinse thoroughly by hand.

### Warning

Foreign objects in the drum may damage the laundry. Before loading the laundry, check that there is no debris in the drum.



- ❑ Open the washing machine door.

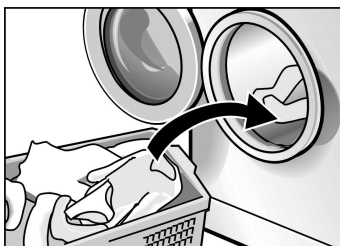

- ❑ Unfold the sorted items of clothing and place them loosely into the drum. Mix large and small items. Laundry items which vary in size are more evenly distributed during the spin cycle.

- ❑ **i** Do not exceed recommended loads. Overloading will cause poor wash results and encourage creasing.

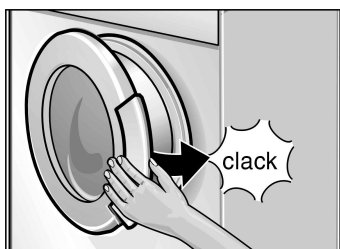

- ❑ Close the washing machine door. Take care not to trap any items of clothing between the loading door and rubber seal.

---

# Detergents and cleaning products

---

## Dosing detergent

### **⚠ Risk of poisoning!**

Keep detergents and additives out of the reach of children.

Dose detergent according to

- the water hardness. You can find out the water hardness from your water utility company.
- the amount of laundry.
- the degree of soiling.  
Information on soiling can be found on page 11.
- the specifications of the detergent manufacturer.  
The correct dosage reduces the impact on the environment and produces a good washing result.

Pour liquid detergent into the corresponding dispenser.

### **Too little detergent:**

- The laundry is not washed clean and eventually becomes grey and hard.
- Greyish-brown dots (grease spots) may stain the laundry.
- The heating elements are calcifying.

### **Too much detergent:**

- The environment is loaded.
- Excessive froth may be generated during the wash cycle causing a reduction in the washing mechanism. This may be the cause of poor washing and rinsing results.

## Adding detergent/ cleaning product

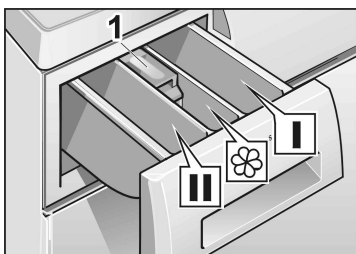

Dispenser I  
Detergent for prewash or starch.

Dispenser II  
Detergent for main wash, water softener, pre-soaking agent, bleach and stain removal product.

Dispenser ☼  
Cleaning product, e.g. fabric softener or fabric conditioner (do not fill above the lower edge of the insert **1:MAX**).

- i** Concentrated or viscous fabric softener or fabric conditioner must be diluted with a little water before it is poured into the dispenser (prevents the overflow from becoming blocked).
- Pull out the detergent drawer all the way.
- Pour in detergent and/or cleaning product.
- Close the detergent drawer.

---

# Programmes and functions

Select the desired programme.

For maximum spin speeds of the programmes see Page 18.

---

## Programme selector

### Basic programmes

**Cottons**   **cold, 30-Quick** , **40, 60 °C**

For hard-wearing textiles, e.g. made of cotton or linen.

**Cottons**   **90 °C +Prewash** 

Energy-intensive programme for heat-resistant textiles, e.g. made of cotton or linen.

To protect the waste-water pipes, the hot water is mixed with approx. 5 litres of cold water and cooled before being drained.

**Easy-Care**  **cold, 40, 60 °C**

For easy-care textiles, e.g. made of cotton, linen, synthetic or blended fabrics.

**Delicates**  **cold, 30 °C**

For delicate, washable textiles, e.g. silk, satin, synthetic materials or blended fabrics (e.g. curtains).

Delicates cycle at 30 °C for hand and machine washable silk.

 We do not recommend washing these textiles with other rougher textiles.

No spin between the rinse cycles.

**Wool**   **cold, 30 °C**

For hand and machine washable wool or wool-rich textiles, e.g. cashmere, mohair or angora.

Also suited for hand washable silk.

## Programme options

### Single wash

Single wash cycle (without drain and spin cycle).

### Single rinse

Rinse cycle with subsequent spin cycle for rinsing hand-washed items or for starching.

### Single spin

Spin cycle for spinning hand-wash items. Washing water or rinsing water is drained before the spin cycle.

---

## Additional options - buttons

### Stains

The washing time is extended so that highly soiled washing or 5.0 kg of cottons/coloureds are washed more intensively.

### Rinse plus

An additional rinse cycle is carried out; Washing time is extended accordingly.

Recommended applications:

- in areas with very soft water.
- for further improvement of the rinsing results.

## Spin speed

In the **Cottons**  programme the fabric will be spun at the maximum possible spin speed.

In the **Easy-Care** , **Delicates**  and **Wool**  programmes the washing machine spins at a low speed - for gentle treatment of delicate laundry.

### Maximum spin speeds

Revolutions per minute	Type of laundry / Programme options
X 08:06	
850	Cottons
800	Easy-Care
600	Delicates
800	Wool
800	Single rinse
800	Single spin

### Unbalanced load detection system

The automatic unbalanced load detection system spins the laundry several times to ensure even distribution.

# Washing



- ❑ Turn on water tap.

## Start programme

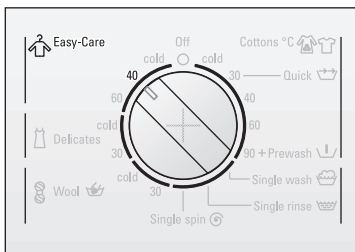

- ❑ Turn the programme selector to the desired programme .  
“⏻” indicator light flashes.

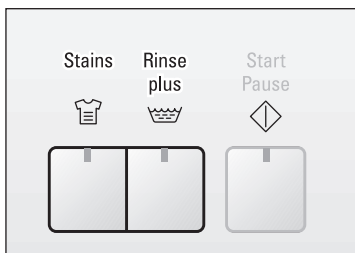

- ❑ If required, press the button(s) for additional option(s).  
The indicator light of the selected button is on.

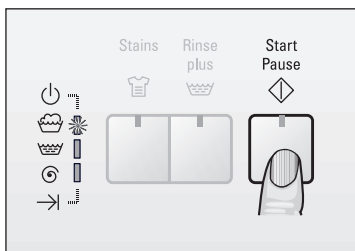



- ❑ Press the “◇” button.  
“⏻” indicator light stops flashing and “🧺” indicator light comes on. The programme starts.

---

## Changing the programme





If you have accidentally selected the wrong programme:

- ❑ Turn the programme selector to **Off** .
- ❑ Turn the programme selector to the desired programme.  
“” indicator light flashes.
- ❑ Press the “” button.  
“” indicator light comes on. The new programme starts.

---

## Cancelling the programme

If you wish to prematurely end a programme:

- ❑ Turn the programme selector to **Off** .
- ❑ Turn the programme selector to “**Single spin** ”.  
“” indicator light flashes.
- ❑ Press the “” button.  
“” indicator light stops flashing, “” indicator light is on.

# When the programme has Ended

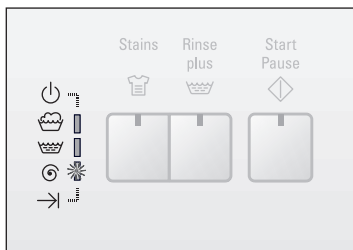

- i** "→" indicator light flashes.
- Turn the programme selector to **Off**.
- i** If required:
  - Select an additional programme (" **Single spin** " or " **Single rinse** ").
  - Press the " **◇** " button.
  - At the end of the programme option, turn the programme selector to **Off**.

## Unload the laundry



- Turn off the water tap.
- Open the washing machine door.

If the loading door cannot be opened:  
Wait 2 minutes (safety function is active)

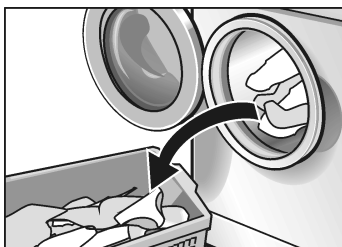

- Unload the laundry.

### Warning

Remove any foreign objects (e.g. coins, paper clips) from the drum and rubber seal – **risk of rust!**





- Leave the washing machine door and detergent-drawer open to allow the interior of the washing machine to dry.

---

# Special applications

---



## Soaking

- Load laundry of the same colour.
- Pour soaking agent into dispenser **II** according to the manufacturer's instructions.
- Set the programme selector to "**Cottons**  **30 °C Quick** 
- Press the "" button.  
The programme starts.
- After approx. 10 minutes, turn the programme selector to  **Off** . The laundry is left to lie in the water.
- Select a programme according to the required soaking time, the detergent solution is pumped out.
- i** Only little detergent to be dispensed for the main wash.

---

## Starching

The laundry must not be treated with fabric softener.

- Insert the washing.
- Dose a quantity of starch for approx. 15 litres of water. Dissolve starch according to the manufacturer's instructions.
- Turn the programme selector to "**Single rinse** ".
- Press the "" button.  
As soon as the water runs in:
  - pull out the detergent drawer a little and
  - pour starch solution into dispenser **I**.
  - Close the detergent drawer.

---

## Dyeing



Only use dyes that are environmentally compatible and suitable for use in washing machines.

### Caution

Washing in subsequent wash cycles may become discoloured.

- Apply dyes according to the manufacturer's instructions.

After dyeing:

- Pour approx. ½ measuring beaker of detergent into dispenser II.
- Without any laundry in the drum, allow the “**Cottons**  **90 °C +Prewash**  ” programme to run through.
- Wipe out the rubber seal.

---

## Bleaching

### Caution

Bleaches may contain sulphur or chlorine which can corrode components of the washing machine. Do not bleach washing in the washing machine.

---

# Cleaning and care

## **⚠ Risk of electric shock!**

First, always disconnect the appliance from the power supply.

Never clean the appliance with a water jet.

## **⚠ Risk of explosion!**

Never clean the appliance with solvents.

---

## Clean the appliance housing and control panel

As required:

- Use hot soapy water or a mild, non-abrasive cleaning agent.
- Wipe dry with a soft cloth.

---

## Cleaning the drum

If metal items (e.g. coins, paper clips, needles, nails) left in the drum have caused rust spots:

- Use chlorine-free cleaning agents; comply with the manufacturer's instructions. Never use steel wool.

## Cleaning the detergent dispenser

In the event that residual detergents or additives have accumulated:

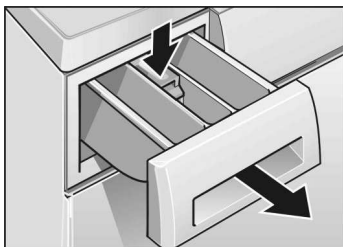

- Pull out the detergent drawer all the way,
- press down the insert and
- remove the detergent drawer.

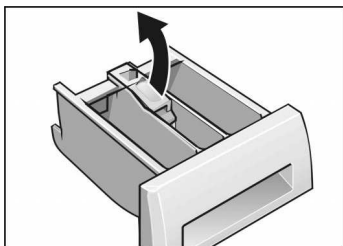

- Open the cover.
- Clean the detergent drawer and cover under running water and dry.

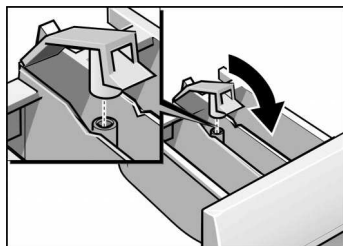

- Close the cover and lock into position.
- i** Insert the cover cylinder onto the guide pin.
- Slide in the detergent drawer.

## Cleaning the drain pump

### Drain the water

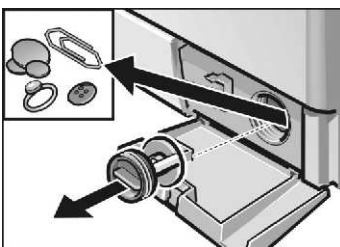
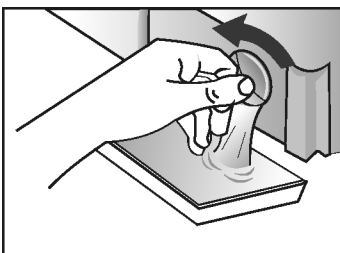
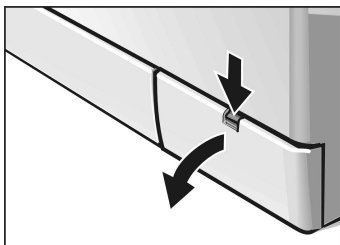

This is necessary if the washing solution has not been completely drained. The pump is blocked by either loose debris or fluff which accumulates if fluff-giving fabrics are washed.

(Up to 20 litres. Have a suitable container ready.)

### **⚠ Risk of scalding!**

Allow the hot water to cool down beforehand. Keep children and pets away.

- Turn the programme selector to **Off**.
- Open service flap.
- Carefully unscrew the pump cap - do not remove it completely - and let the water drain out into a shallow container (let the remainder drip onto a floor cloth). Repeat the operation until there is no water left in the machine.
- Remove the pump cover.
- Remove foreign objects/fluff from inside and clean the interior. The pump impeller wheel must be able to rotate.  
Clean any residual lye or fluff from the thread of the pump cover and pump housing.
- Insert the pump cover and screw tight.
- Insert and close the service flap.



To prevent unused detergent from flowing into the drain during the next wash cycle:

- Pour 1 litre of water into chamber II.
- Select the “ **Single spin**  ” programme.

## Cleaning water inlet strainers

This is necessary if very little or no water flows into the washing machine.

First, reduce the water pressure in the inlet hose:

- Turn off the tap.
- Turn the programme selector to any programme (except **Single spin** ).
- Press the “” button, and allow the programme to run for approx. 40 seconds.

### Cleaning the strainer at the water tap

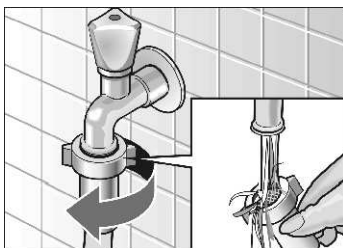

- Disconnect the hose from the water tap.
- Rinse the strainer under flowing water.
- Connect the hose.

### Cleaning the strainer on the washing machine



- Disconnect the hose from the back of the washing machine.

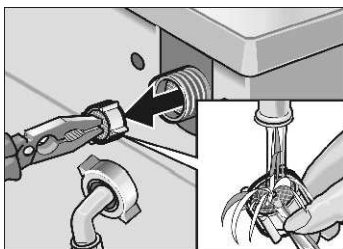

- Pull out the strainer and rinse under running water.
- Insert the strainer and reconnect the hose.
- Turn on the water tap and check whether water is still discharged. If water is leaking, check that the filter is correctly seated.
- Turn off the tap.

---

## Descaling the washing machine

### **Attention**

Descaling agents contain acids which may corrode the components of the washing machine and discolour the laundry.

Provided that you use the correct amount of detergent, it is not necessary to descale the washing machine.

If descaling is nevertheless required, please follow the instructions supplied by the manufacturer of the descaling agent.

# Troubleshooting Minor Faults

## **⚠ Risk of electric shock!**





Repairs may be carried out by customer service or authorised technicians only.

If repairs are needed, and assuming that you cannot eliminate the fault yourself with the aid the following table:

- Turn the programme selector to **○ Off** .
- Disconnect the appliance from the mains.
- Turn off the tap.
- Call customer service, see page 33.













<b>Fault</b>	<b>Cause</b>	<b>Remedial action</b>
Washing machine door cannot be opened.	There's water in the drum.	Select " Single spin  " .
	Safety function is active.	Wait for 2 minutes.
Detergent residue in the detergent drawer.	Damp or lumpy detergent.	Clean and dry the detergent dispenser; see Page 25.
		Use the dosing aid for liquid detergent.
Control lights do not come on.	A fuse has triggered.	Switch on/replace the fuse.
	Power failure.	If the fault occurs repeatedly, call Customer Service.
		An interrupted programme will be resumed when the power returns. If the washing is to be removed, proceed as described under "Cleaning the drain pump"; see from Page 26.
	Plug is loose or not plugged in.	

Fault	Cause	Remedial action
Programme does not start. The “⏻” and “👑” indicator lights flash.	Loading door not closed properly.	Check whether laundry is trapped in door. Close the loading door (a click should be heard).
	“◊” button not pressed.	Press the “◊” button.
Water does not enter the machine or detergent is not washed away. The “⏻” and “→” indicator lights flash.	Tap not turned on.	Turn the tap on.
	Inlet hose kinked or pinched. Filter blocked in water inlet hose.	Clean the strainer; see from page 27.
Detergent in chamber I is not washed away.	A programme without Prewash was selected.	Select programme with Prewash, “Cottons 90 °C + Prewash ↘”.
Water not visible in the drum.	Not a fault. The water lies below the visible part of the drum.	
Washing solution is not completely drained. The “👑” and “→” indicator lights flash.	Pumped blocked by foreign objects.	Clean the pump (refer to page 26).
	Fluff-producing laundry was washed. The water drainage pipe or drain hose is blocked.	Clean drainage pipe and/or drainage hose.
Water runs out from under the appliance.	Screw fitting of the inlet hose is leaking.	Tighten the screw-fitting.
	Drainage hose is leaking.	Replace the drain hose.
Foam comes out of the detergent drawer.	Too much detergent or detergent not suitable for use in washing machines used.	Mix 1 tablespoon of fabric softener with ½ litre of water and pour into chamber II of the detergent dispenser.
		Reduce detergent dosage for next wash cycle or use detergent which is suitable for use in washing machines.
The washing has not been spun correctly.	Large laundry items have become entangled and are not evenly distributed in the drum. For safety reasons, the high-speed final spin cycle was automatically cancelled.	Always load large <b>and</b> small items together into the drum. (see also imbalance compensation system).

<b>Fault</b>	<b>Cause</b>	<b>Remedial action</b>
Spin result unsatisfactory.	The <b>Single rinse</b>  or <b>Single spin</b>  programme selected maximum spin speed: see page 18.	
Spin cycle actuated several times.	Not a fault. Unbalanced load detection system is attempting to compensate the imbalance by spinning the washing several times.	
The programme takes longer than usual.	Not a fault. Imbalance compensation system attempts to balance the laundry by repeated distribution.	Wash large and small items together in order to reduce the imbalance.
	The foam detection feature has activated an additional rinsing cycle to reduce the amount of foam.	Adjust the detergent dosage for the next wash cycle.
Washing result not satisfactory.	Soiling is greater than expected or recommended load has been exceeded.	Select suitable programme and press the <b>Stains</b>  button or reduce load.
	Detergent was underdosed.	Dose detergent according to the manufacturer's instructions.
Detergent residue on the washing.	Some phosphate-free detergents contain water-insoluble residue which may appear as light stains on the washing.	Select <b>Single rinse</b>  immediately or brush out the washing after drying.
Grey residue on the washing.	Soiling caused by ointment, grease or oil.	Select maximum detergent dosage and maximum permitted temperature for the next wash cycle.

If the fault recurs, call customer service, see page 33.

# Consumption values

Normal programme	Additional option	Load	Consumption values **		Programme duration
			Power	Water	
<b>Cottons</b>  <b>30 °C Quick</b> 	–	3.0 kg	0.24 kWh	42 l	0:39 h
<b>Cottons</b>  <b>40 °C</b>	–	4.0 kg	0.48 kWh	49 l	1:20 h
<b>Cottons</b>  <b>60 °C</b>	–	4.0 kg	0.88 kWh	49 l	1:30 h
<b>Cottons</b>  <b>60 °C</b>	 *	4.0 kg	0.76 kWh	45 l	2:18 h
<b>Cottons</b>  <b>90 °C +Prewash</b>  (the hot washing solution is mixed with approx. 5 litres of cold water before being drained)	–	4.0 kg	1.77 kWh	68 l	2:05 h
<b>Easy-Care</b>  <b>40 °C</b> (also suitable as short programme)	–	2.0 kg	0.30 kWh	40 l	1:00 h
<b>Delicates</b>  <b>30 °C</b>	–	1.5 kg	0.24 kWh	44 l	0:55 h
<b>Wool</b>  <b>30 °C</b> 	–	2.0 kg	0.13 kWh	30 l	0:40 h

\* Programme setting with  option for test in accordance or in conformity with EN 60 456 and IEC 60 456.

\*\* Consumption values will differ from the indicated values depending on the water pressure, water hardness, water inlet temperature, ambient temperature, type and quantity of laundry and degree of soiling, utilised detergent, fluctuations in the mains voltage and selected additional options.

# Customer service

Before you call customer service, please check whether you can eliminate the fault yourself (see from page 29).

A technician who is called out to give advice will charge you, even if the appliance is still under guarantee.

You can find your nearest customer service in the enclosed address list. Please provide customer service with the product number (E-Nr.) and the production number (FD) of the appliance.

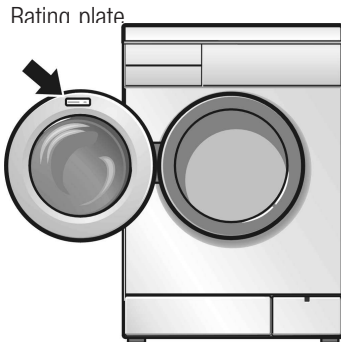

These numbers are shown on the rating plate which can be found on the frame of the open door and also on the identification plate, enclosed by a thick line, on the front of the machine behind the nameplate.

E-Nr. _____	FD _____
-------------	----------

Product number

Production number

Please note the two numbers in the space provided above.

In specifying the product number and production number of your appliance, you help us in our attempt to prevent unnecessary travelling and the associated extra costs.

---

# Installing, connecting and transporting

---

## Safety instructions

### ⚠ Risk of injury!

The washing machine is heavy. Take care when lifting it.

### Caution

Frozen hoses may tear/burst. Do not install the washing machine in an area where there is a risk of frost or outdoors.

The washing machine may be damaged. Do not lift the washing machine by its projecting parts (e.g. door).

In addition to the safety information listed here, the local water and electricity supplier may have special requirements.

If in doubt, have the appliance connected by a specialist.

---

## Standard accessories

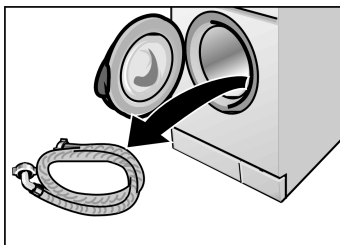

Inside the drum:

- Water-inlet hose.

Moisture in the drum is due to the final inspection which every washing machine undergoes before it leaves the factory.

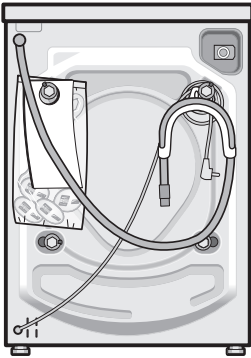

On the rear of the washing machine:

- Water drainage hose.
- Elbow for attaching the drain hose, e.g. into a wash basin
- Power cord.
- Covers for holes left by removing the transport bolts.

Depending on the connection situation, the following part is also required:

- 1 hose clip  $\varnothing$  24–40 mm (DIY store) is also required for connection to a siphon.

## Useful tools

The following tools are helpful:

- Ring wrench (SW 13)
- Spirit level

---

## Dimensions

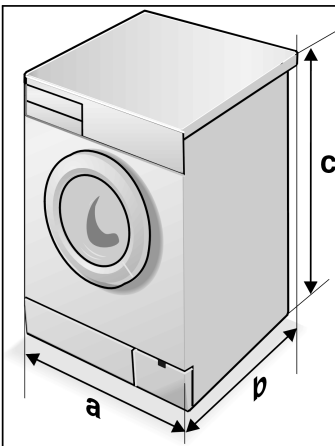

**a** = 600 mm

**b** = 400 mm

**c** = 850 mm

Weight approx. 63 kg

---

## Installation surface

Appliance stability is important so that the washing machine does not “wander” during the spin cycles.

The installation surface must be solid and level. Soft floor coverings, e.g. carpets or floor coverings with a foam backing are not suitable.

If the washing machine is to be installed on a wooden floor:

- If possible, install the washing machine in a corner.
- Screw a water-resistant wooden board (at least 30 mm thick) to the floor.
- Secure the washing machine feet with fixing brackets\*.

If the washing machine is to be installed on a base:

- Secure the washing machine feet with fixing brackets\*.

\* Holding brackets (set) can be obtained from a specialist store or the Customer Service, order no. WZ 2200.

---

## Built-under or built-in appliance installation

The appliance must be built under or built in prior to connecting the power supply.

The appliance can be built into or under a kitchen work surface. For this purpose, a recess width of 60 cm is required.

- The washing machine must only be installed under a one-piece worktop that is permanently attached to the surrounding cabinets.

### Warning

For safety reasons in built-under installation, a metal cover\* must be assembled by a specialist in place of the appliance cover plate.

\* Cover plate (set) can be obtained from a specialist store or the Customer Service, order no. WZ 10170.

## Removing the transportation protection devices

### Caution

The transport bolts must always be removed before using the appliance for the first time and must be retained for any subsequent transport (e.g. when moving).

- ❑ Release all screws and using the SW 13 wrench until they can be moved freely.
- ❑ Removing the transportation protection devices  
Through the open washing machine door have a second person pull the top of the drum forwards. Remove transportation protection devices.

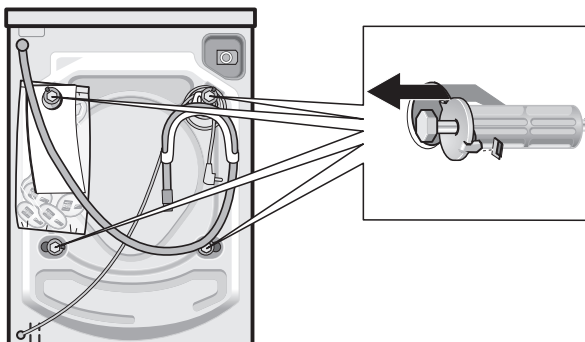

- ❑ Insert the covers.

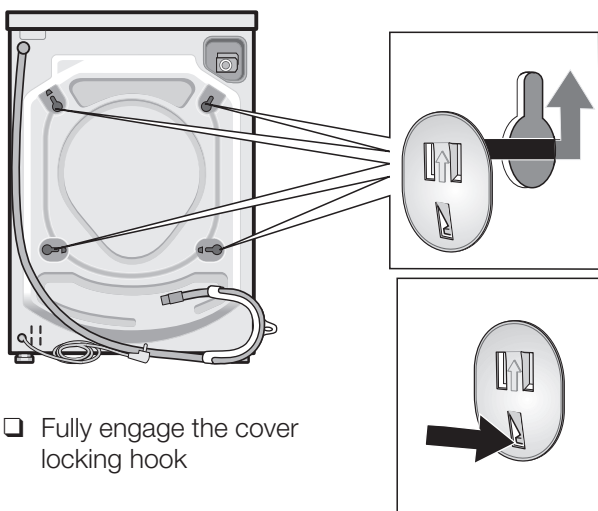

- ❑ Fully engage the cover locking hook

# Hose and-cable lengths

## Connection on left side

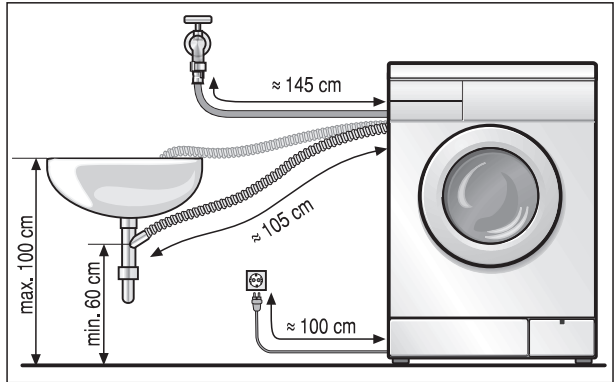

## Connection on right side

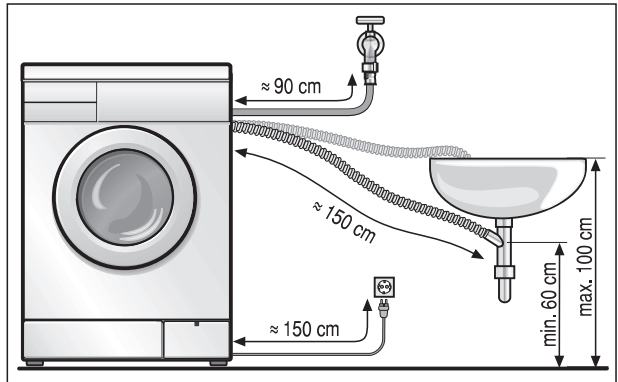

## Other hoses

Available from specialist dealers:

- Extended supply hose (approx. 2.20 m).

# Connecting the water

## Water inlet hose

### ⚠ Risk of electric shock!

To prevent leaks or water damage, it is essential to follow the instructions in this chapter!

### Warning

Operate the washing machine with cold drinking water only. Do not connect to the mixer tap of an unpressurised hot-water apparatus.

If in doubt, have the appliance connected by a specialist.

Do not use a used inlet hose. Only use the inlet hose supplied or one which was purchased from an authorised specialist dealer.

The water inlet hose must not be

- kinked or crushed,
- modified or severed (strength is no longer guaranteed).

Plastic threads must only be tightened by hand. Do not remove the strainers from the water supply hose.

Check the mains water pressure:

- The water pressure should be between 1 and 10 bars (when the tap is turned on, at least 8 litres of water is discharged per minute).
- If the water pressure is higher, install a pressure reducing valve.

Connect the water supply hose

- to the rear panel of the washing machine and ...

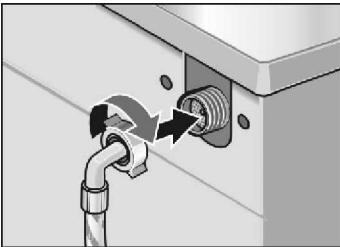

- to the tap.

- After connecting the water inlet hose: Turn on the water tap completely, and check connection points for water-tightness.

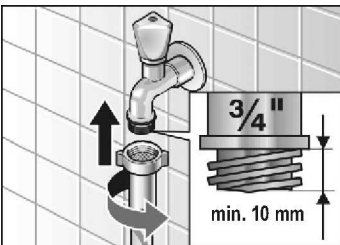

## Water drainage hose

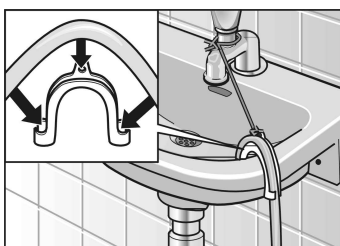
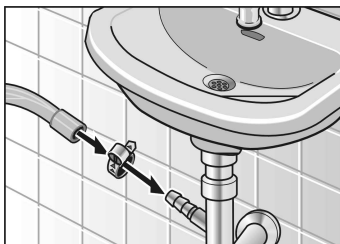

### Warning

Do not bend or pull the water drainage hose.

Height difference between the placement area and drainage point: maximum 100 cm.  
minimum 60 cm.

Drainage into a siphon:

- Secure connection point with 24-40 mm Ø hose clip (specialist outlet).

Drainage into a wash basin:

### Warning

The plug must not block the drain of the wash basin.

- Secure the drainage hose to prevent it from slipping out of the sink.
- When the water is being pumped out of the washing machine, check that the water drains away quickly enough.

## Aligning the washing machine

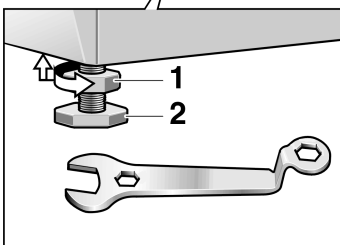
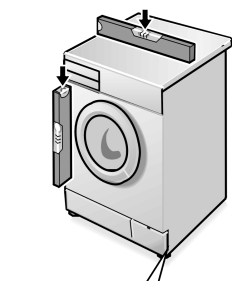

Level the washing machine with the assistance of the four adjustable feet and a spirit level:

- Loosen the lock nut **1** using the wrench.
- Adjust the height by rotating the foot **2**.
- Tighten the lock nut **1** against the housing.

All four appliance feet must be firmly on the ground. The washing machine must not wobble. The lock nuts on all four appliance feet must be tightened against the housing.

### Attention

Loud noises, vibrations and “wandering” may be due to incorrect alignment!

---

## Connecting the power

### Caution

Connect the washing machine only to an alternating current via a correctly installed earthed socket.

The mains voltage must correspond to the voltage specification on the washing machine (nameplate). Connection specifications as well as the required fuses are stipulated on the appliance nameplate.

Ensure that:

- The mains plug and socket are compatible.
- The cable cross-section is adequate.
- The earthing system has been installed correctly.

The mains cable may be changed (if required) by an electrician only.

Replacement mains cable available from Customer Service.

Do not use multiple plugs/sockets or extension cables.

In the event that an earth-leakage circuit breaker is to be used, only use types marked with the following symbol: .

Only this symbol can guarantee compliance with all current regulations.

Do not insert/pull out the mains plug with wet hands.

Do not pull out the mains plug by tugging the cable.

## Transport, e.g. when moving

Before transporting the washing machine:

- Turn off the tap.
- Reduce the water pressure in the water inlet hose (refer to page 27).
- Drain any residual washing solution (refer to page 26).
- Disconnect the washing machine from the mains.
- Dismantle the supply and drainage hose.
- Install transportation protection devices.

Having transported the appliance and ensured proper installation and connection, allow the “**Single spin** Ⓢ” programme to run through before starting the first wash programme.

Transporting the washing machine:

### Preparing and inserting the transport bolts

- Remove the lower covers.
- Prepare the transport bolts:  
Loosen the screw in the sleeve until the end of the screw is level with the end of the sleeve.
- Attach and close the cover plate.  
The catch on the washer must sit inside the groove on the rear housing panel.

