

# Safety instructions

- The washing machine is heavy - take care when lifting.
- **Caution:** frozen hoses may rip/burst. Do not install the washing machine in areas exposed to frost or outdoors.
- The washing machine could be damaged. Do not lift the appliance by protruding components (e.g. the washing machine door).
- In addition to the instructions provided in this document, special regulations from the relevant water and electric utility companies may apply.
- If in doubt, have a technician connect the appliance.
- Lay hoses and cables in such a way that there is no risk of tripping.

# Scope of delivery

Moisture inside the drum is due to final testing.

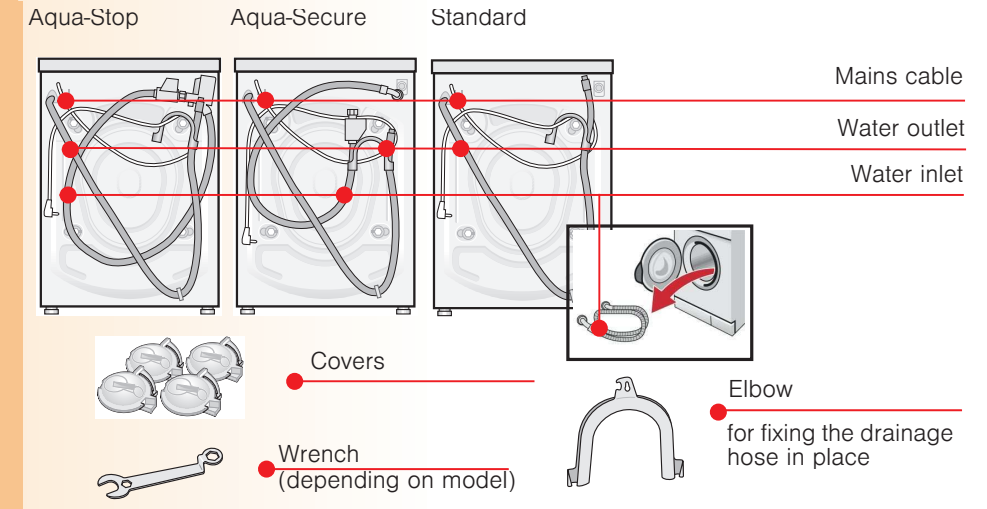

- Also required, depending on the connection:**
- 1 hose clamp Ø 24-40 mm (exclusive dealers) to connect to a siphon → page 4; water connection.
- Useful tools**
- Spirit level for installation.
  - Spanner WAF 13 for undoing the transport safety bolts → page 3 and Spanner WAF 17 for levelling the appliance feet → page 5.

# Installation surface

- The machine must be stable so that it does not move around.
- The installation surface must be firm and level.
- Soft floors/floor coverings are not suitable.

- Installation on a pedestal**
- The feet of the washing machine **must** be secured with holding brackets\*. \* order no. WMZ2200, WX9756, CZ110600, Z7080X0

- Installation on a wood joist floor**
- If possible, place the washing machine in a corner.
  - Screw a water-resistant wooden board (min. 30 mm thick) to the floor.
  - The feet of the washing machine **must** be secured with holding brackets\*. \* order no. see above.

# Hose and cable lengths depending on model

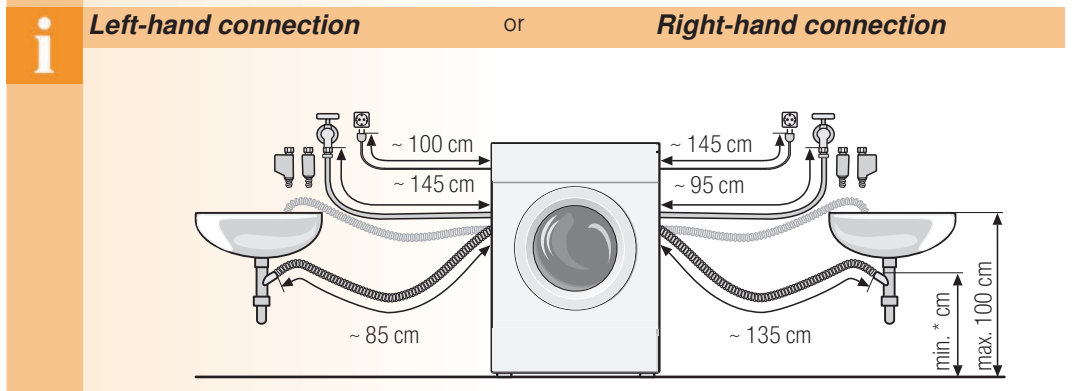

- Available from specialist dealers/the after-sales service:
- Extension for Aqua-Stop or cold-water inlet hose (approx. 2.50 m). order no. WMZ2380, WZ10130, CZ11350, Z7070X0
  - Longer inlet hose (approx. 2.20 m) for standard model.

# Installing the appliance

- Risk of electric shock.**
- For models with a continuous appliance covering plate or a square service flap, the appliance covering plate can be replaced by a metal cover. **Instead of the appliance covering plate, you must have a metal cover fitted by an expert.**
  - For models with a non-continuous appliance covering plate or a round service flap, the appliance covering plate **must not be removed.**
- Information:**
- Only install the washing machine underneath a continuous worktop that is securely connected to adjacent cabinets.
  - Recess width of 60 cm required.

# Removing the transport braces

- Before using the appliance for the first time, make sure that you completely remove transport braces and keep them for subsequent transportation.
- If you need to transport the appliance at a later date, always re-affix the transport braces to prevent damage to the machine → page 6.
- Store the screw and sleeve screwed together.

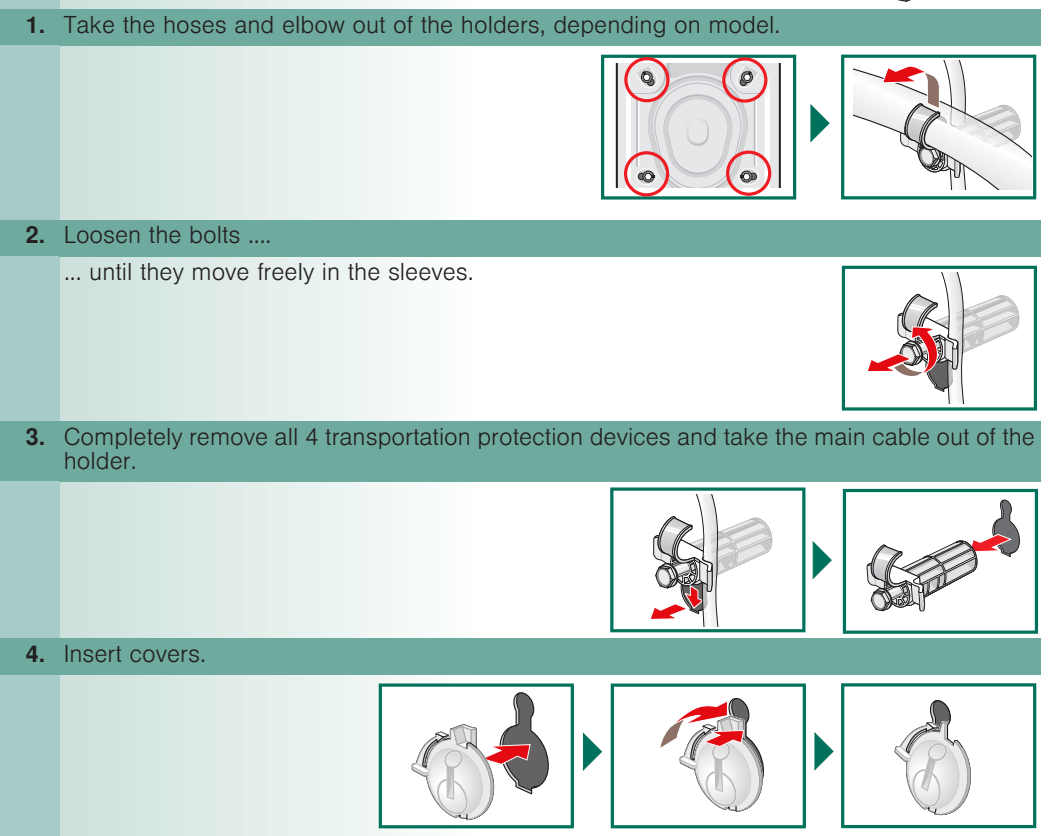

# Water connection

- **Risk of electric shock.** Do not immerse the Aqua-Stop safety device in water (contains an electric valve).
- To prevent leaks or water damage, observe the instructions in this section.
- **Caution:** only operate the washing machine using cold drinking water.
- Do not connect to the mixer tap of an unpressurised hot-water boiler.
- Do not use a used inlet hose. Only use the inlet hose supplied or one which was purchased from an authorised specialist dealer.
- If in doubt, have a technician connect the appliance.

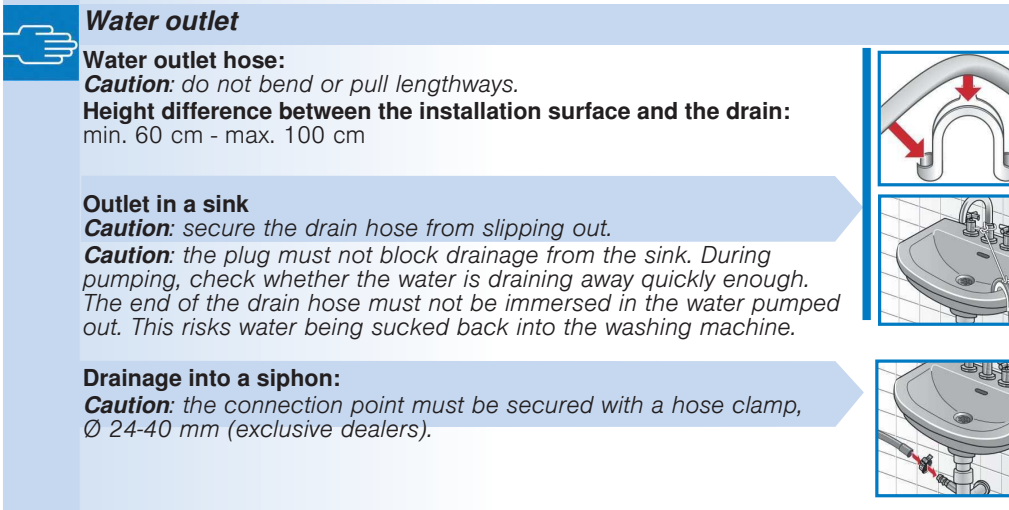
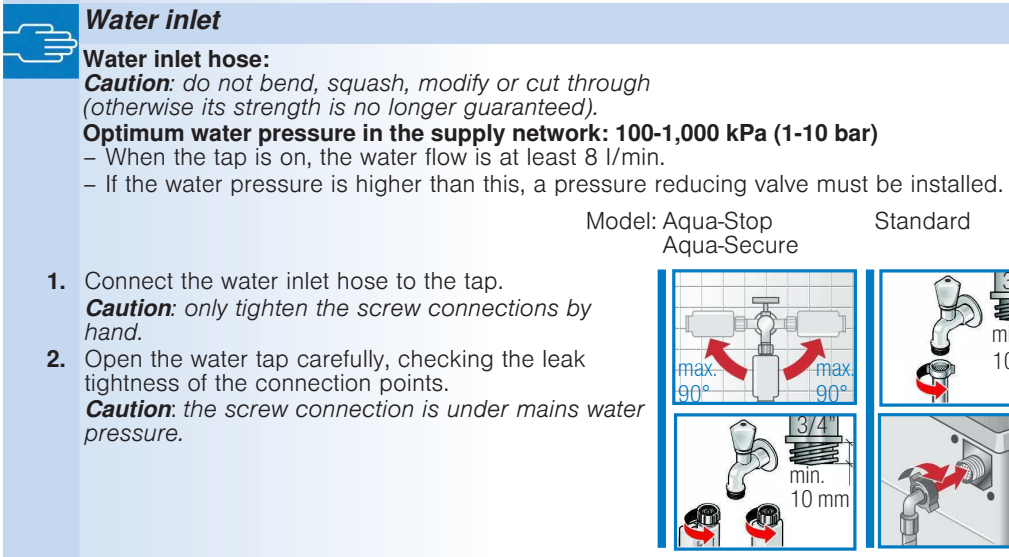

## Alignment

 Intense noise formation, vibrations and "wandering" may be the result of incorrect alignment.

### Aligning the washing machine with a spirit level

1. Loosen the lock nut using a wrench, by turning it in a clockwise direction.

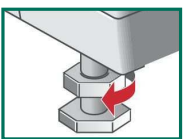

2. Change the height by turning the appliance feet.

**Caution:** all four appliance feet must be firmly on the ground. The washing machine must not wobble.

Check the alignment of the washing machine with a spirit level and adjust if necessary.

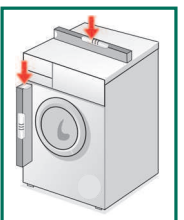

3. Tighten the lock nut against the housing.

In doing so, hold the foot tight and do not adjust its height.

**Caution:** the lock nuts on all four appliance feet must be screwed tightly against the housing.

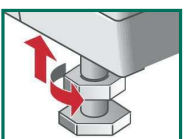

## Electrical connection

- The washing machine must only be connected to an alternating current via a properly installed earthed socket.
- The power supply and voltage indicated on the washing machine (rating plate) must be the same.
- The connected load and fuse required are specified on the rating plate.
- Make sure that:
  - the mains plug fits the socket,
  - the cable cross-section is adequate,
  - the earthing system is properly installed.
- (If this is necessary), the mains cable may only be replaced by a qualified electrician. Replacement mains cables are available from the after-sales service.
- Do not use multiple plugs/couplings or extension cables.
- If a residual current circuit breaker is used, only use a type which displays this symbol: . Only this symbol guarantees compliance with the currently applicable regulations.
- Do not plug in or unplug the mains plug with wet hands. Pull the appliance plug out of the socket at the plug only, not by the cable.

## Transportation, e.g. when moving home

### 1. Before transporting the washing machine:

1. Turn off the tap.
2. Release the water pressure in the inlet hose → Operating instructions; Maintenance - filter in water inlet.
3. Drain residual water → Operating instructions; Maintenance - drain pump.
4. Disconnect the washing machine from the power supply.
5. Dismantle the hoses.

### 2. Preparing and installing transport braces:

1. Remove the covers.

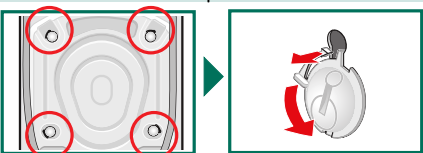

2. Insert all 4 transportation protection devices and clamp the mains cable to the holders. Tighten the bolts.

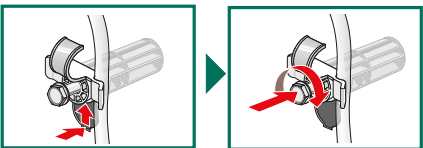

After transportation, the transport braces **must** be removed → page 3.



To prevent unused detergent from flowing straight into the drain during the next wash: Pour 1 litre of water into compartment II and start the **Empty** programme.

## Technical specifications

- Dimensions (width x depth x height)** 60 x 59 x 84.7 cm
- Weight** 69 - 83 kg *depending on model*
- Mains connection** Nominal voltage 220-240 V, 50 Hz  
Nominal current 10 A  
Nominal power 2000 - 2300 W
- Water pressure** 100-1000 kPa (1\*-10 bar)

#### Note:

\* Appliance can function even at 0.3bar/ 30kPa water pressure under specified loading conditions as mentioned in programme overview → page 7 in operating instructions.

## After-sales service

- Before you call the after-sales service, please make sure that you cannot remedy the fault yourself → Operating instructions; What to do if...
- You will be charged if a technician is called out, even during the warranty period.
- You can find your nearest after-sales service in the enclosed list. Please give the after-sales service the product number (E no.) and the production number (FD) of the appliance.

E-Nr. \_\_\_\_\_ FD \_\_\_\_\_

Product number      Production number

You will find the identification plate containing this information on the frame of the loading door when the door is open, and in the thickly-bordered area of the rating plate on the back of the appliance.

- Please help us to avoid unnecessary call-outs by quoting the product and production numbers. This will also save you the associated additional costs.

## Aqua-Stop warranty only for appliances with Aqua-Stop

In addition to warranty claims against the vendor from the purchase agreement and to our appliance warranty, we will pay damages under the following conditions:

1. If a fault in our Aqua-Stop system causes water damage, we will reimburse damages caused to private customers.
2. The liability guarantee is valid for the service life of the appliance.
3. It is a prerequisite of all warranty claims that the appliance with Aqua-Stop must have been set up and connected correctly in accordance with our instructions; this also includes a correctly fitted Aqua-Stop extension (original accessories). Our warranty goes not cover defective power cables or fittings between the Aqua-Stop connection and the tap.
4. Appliances with Aqua-Stop do not need to be supervised during operation, nor secured afterwards by turning off the tap. The tap only needs to be turned off if you are away from home for a long period, e.g. for several weeks' holiday.

## Contents

Page

■ Safety instructions . . . . .	1
■ Scope of delivery . . . . .	1
■ Installation surface . . . . .	1
■ Hose and cable lengths . . . . .	2
■ Installing the appliance . . . . .	2
■ Removing the transport braces . . . . .	3
■ Water connection . . . . .	4
■ Alignment . . . . .	5
■ Electrical connection . . . . .	5
■ Transportation, e.g. when moving home . . . . .	6
■ Technical specifications . . . . .	6
■ After-sales service . . . . .	7
■ Aqua-Stop warranty . . . . .	7



**Read these instructions before switching on the washing machine. Also observe the separate instruction manual. Keep all documents for use in the future or for the subsequent owner.**

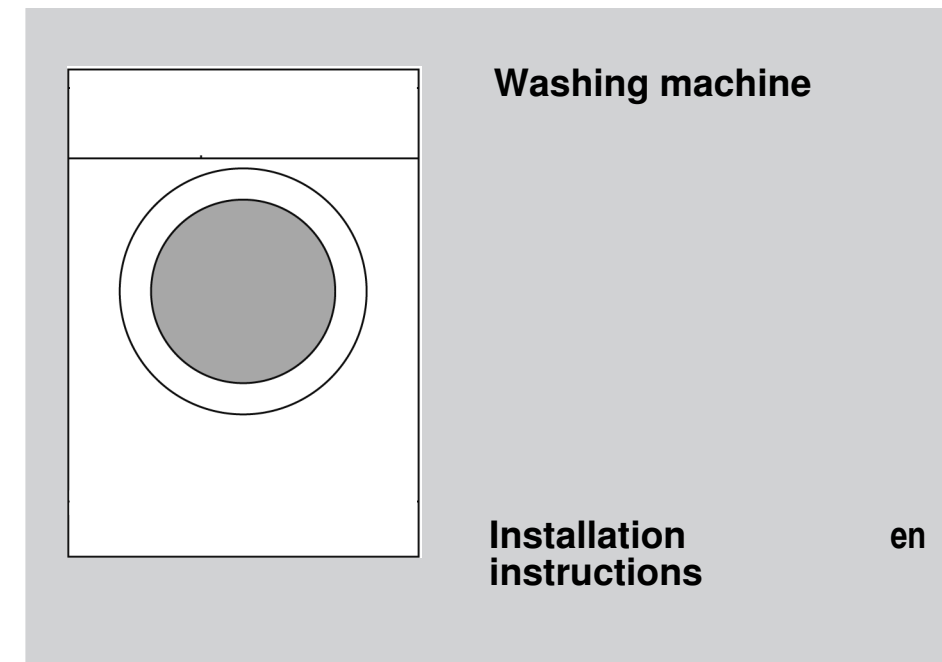

## Safety instructions

- The washing machine is heavy - take care when lifting.
- Caution: frozen hoses may rip/burst. Do not install the washing machine in areas exposed to frost or outdoors.
- The washing machine could be damaged. Do not lift the appliance by protruding components (e.g. the washing machine door).
- In addition to the instructions provided in this document, special regulations from the relevant water and electric utility companies may apply.
- If in doubt, have a technician connect the appliance.
- Lay hoses and cables in such a way that there is no risk of tripping.

## Scope of delivery depending on model

Moisture inside the drum is due to final testing.

Aqua-Stop

Aqua-Secure

Standard

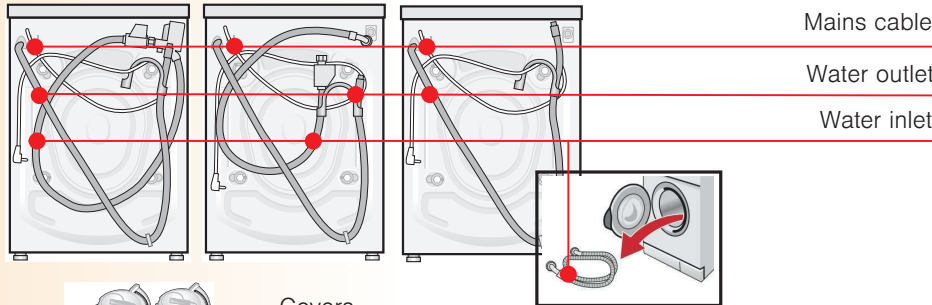

Mains cable

Water outlet

Water inlet



Covers

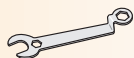

Wrench  
(depending on model)



Elbow  
for fixing the drainage  
hose in place

### Also required, depending on the connection:

- 1 hose clamp Ø 24-40 mm (exclusive dealers) to connect to a siphon  
→ page 4; water connection.

### Useful tools

- Spirit level for installation.
- Spanner WAF 13 for undoing the transport safety bolts → page 3 and Spanner WAF 17 for levelling the appliance feet → page 5.

## Installation surface

- The machine must be stable so that it does not move around.
- The installation surface must be firm and level.
- Soft floors/floor coverings are not suitable.

### Installation on a pedestal

- The feet of the washing machine **must** be secured with holding brackets\*.  
\* order no. WMZ2200, WX9756, CZ110600, Z7080X0

### Installation on a wood joist floor

- If possible, place the washing machine in a corner.
- Screw a water-resistant wooden board (min. 30 mm thick) to the floor.
- The feet of the washing machine **must** be secured with holding brackets\*.  
\* order no. see above.

## Hose and cable lengths depending on model



Left-hand connection

or

Right-hand connection

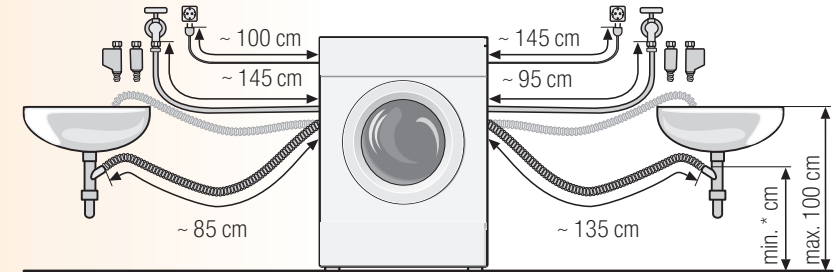

Available from specialist dealers/the after-sales service:

- Extension for Aqua-Stop or cold-water inlet hose (approx. 2.50 m).  
order no. WMZ2380, WZ10130, CZ11350, Z7070X0
- Longer inlet hose (approx. 2.20 m) for standard model.

## Installing the appliance depending on model



Install the appliance before connecting it to the power supply.

### Risk of electric shock.



- For models with a continuous appliance covering plate or a square service flap, the appliance covering plate can be replaced by a metal cover.  
Instead of the appliance covering plate, you **must** have a metal cover fitted by an expert.



- For models with a non-continuous appliance covering plate or a round service flap, the appliance covering plate **must not be removed**.



- Only install the washing machine underneath a continuous worktop that is securely connected to adjacent cabinets.
- Recess width of 60 cm required.

## Removing the transport braces



- Before using the appliance for the first time, make sure that you completely remove transport braces and keep them for subsequent transportation.
- If you need to transport the appliance at a later date, always re-affix the transport braces to prevent damage to the machine → page 6.
- Store the screw and sleeve screwed together.

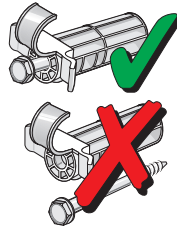

1. Take the hoses and elbow out of the holders, depending on model.

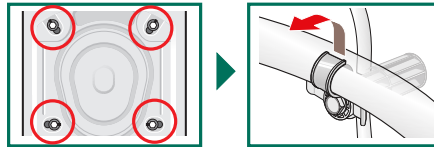

2. Loosen the bolts ....

... until they move freely in the sleeves.

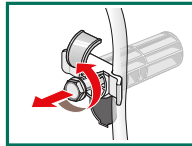

3. Completely remove all 4 transportation protection devices and take the main cable out of the holder.

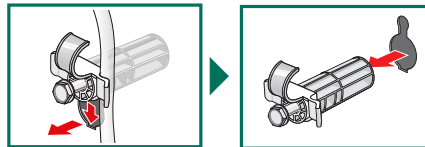

4. Insert covers.

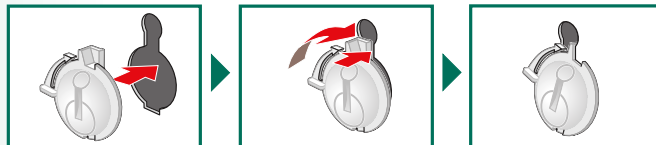

## Water connection depending on model



- **Risk of electric shock.** Do not immerse the Aqua-Stop safety device in water (contains an electric valve).
- To prevent leaks or water damage, observe the instructions in this section.
- **Caution:** only operate the washing machine using cold drinking water.
- Do not connect to the mixer tap of an unpressurised hot-water boiler.
- Do not use a used inlet hose. Only use the inlet hose supplied or one which was purchased from an authorised specialist dealer.
- If in doubt, have a technician connect the appliance.

### Water inlet

#### Water inlet hose:

**Caution:** do not bend, squash, modify or cut through (otherwise its strength is no longer guaranteed).

**Optimum water pressure in the supply network: 100-1,000 kPa (1-10 bar)**

- When the tap is on, the water flow is at least 8 l/min.
- If the water pressure is higher than this, a pressure reducing valve must be installed.

Model: Aqua-Stop  
Aqua-Secure

Standard

1. Connect the water inlet hose to the tap.  
**Caution:** only tighten the screw connections by hand.

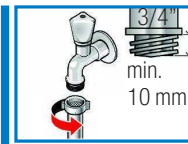
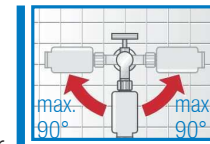

2. Open the water tap carefully, checking the leak tightness of the connection points.

**Caution:** the screw connection is under mains water pressure.

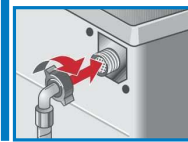

### Water outlet

#### Water outlet hose:

**Caution:** do not bend or pull lengthways.

**Height difference between the installation surface and the drain:**  
min. 60 cm - max. 100 cm

#### Outlet in a sink

**Caution:** secure the drain hose from slipping out.

**Caution:** the plug must not block drainage from the sink. During pumping, check whether the water is draining away quickly enough. The end of the drain hose must not be immersed in the water pumped out. This risks water being sucked back into the washing machine.

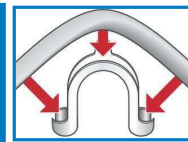

#### Drainage into a siphon:

**Caution:** the connection point must be secured with a hose clamp, Ø 24-40 mm (exclusive dealers).

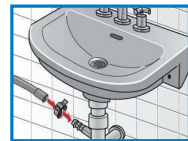

## Alignment

 Intense noise formation, vibrations and "wandering" may be the result of incorrect alignment.

### Aligning the washing machine with a spirit level

1. Loosen the lock nut using a wrench, by turning it in a clockwise direction.

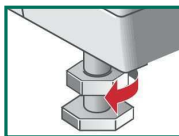

2. Change the height by turning the appliance feet.  
**Caution:** all four appliance feet must be firmly on the ground. The washing machine must not wobble.

Check the alignment of the washing machine with a spirit level and adjust if necessary.

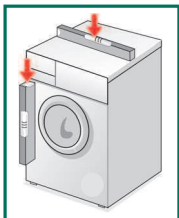

3. Tighten the lock nut against the housing. In doing so, hold the foot tight and do not adjust its height.

**Caution:** the lock nuts on all four appliance feet must be screwed tightly against the housing.



## Electrical connection

- The washing machine must only be connected to an alternating current via a properly installed earthed socket.
- The power supply and voltage indicated on the washing machine (rating plate) must be the same.
- The connected load and fuse required are specified on the rating plate.
- Make sure that:
  - the mains plug fits the socket,
  - the cable cross-section is adequate,
  - the earthing system is properly installed.
- (If this is necessary), the mains cable may only be replaced by a qualified electrician. Replacement mains cables are available from the after-sales service.
- Do not use multiple plugs/couplings or extension cables.
- If a residual current circuit breaker is used, only use a type which displays this symbol: . Only this symbol guarantees compliance with the currently applicable regulations.
- Do not plug in or unplug the mains plug with wet hands. Pull the appliance plug out of the socket at the plug only, not by the cable.

Manufacturer → Operating instructions

9801 / 9000 150 253

5

## Transportation, e.g. when moving home

### 1. Before transporting the washing machine:

1. Turn off the tap.
2. Release the water pressure in the inlet hose → Operating instructions; Maintenance - filter in water inlet.
3. Drain residual water → Operating instructions; Maintenance - drain pump.
4. Disconnect the washing machine from the power supply.
5. Dismantle the hoses.

### 2. Preparing and installing transport braces:

1. Remove the covers.

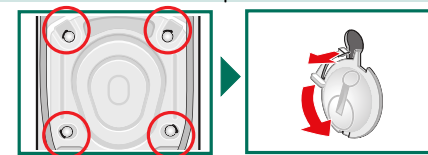

2. Insert all 4 transportation protection devices and clamp the mains cable to the holders. Tighten the bolts.

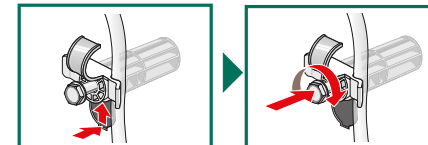

After transportation, the transport braces **must** be removed → page 3.



To prevent unused detergent from flowing straight into the drain during the next wash: Pour 1 litre of water into compartment II and start the **Empty** programme.

## Technical specifications

- **Dimensions (width x depth x height)** 60 x 59 x 84.7 cm
- **Weight** 69 - 83 kg depending on model
- **Mains connection** Nominal voltage 220-240 V, 50 Hz  
Nominal current 10 A  
Nominal power 2000 - 2300 W
- **Water pressure** 100-1000 kPa (1\*-10 bar)

### Note:

\* Appliance can function even at 0.3bar/30kPa water pressure under specified loading conditions as mentioned in programme overview → page 7 in operating instructions.

6

## After-sales service

- Before you call the after-sales service, please make sure that you cannot remedy the fault yourself → *Operating instructions*; What to do if...
  - You will be charged if a technician is called out, even during the warranty period.
  - You can find your nearest after-sales service in the enclosed list. Please give the after-sales service the product number (E no.) and the production number (FD) of the appliance.
- E-Nr.** \_\_\_\_\_ **FD** \_\_\_\_\_
- Product number      Production number
- You will find the identification plate containing this information on the frame of the loading door when the door is open, and in the thickly-bordered area of the rating plate on the back of the appliance.
- Please help us to avoid unnecessary call-outs by quoting the product and production numbers. This will also save you the associated additional costs.

## Aqua-Stop warranty only for appliances with Aqua-Stop

In addition to warranty claims against the vendor from the purchase agreement and to our appliance warranty, we will pay damages under the following conditions:

1. If a fault in our Aqua-Stop system causes water damage, we will reimburse damages caused to private customers.
2. The liability guarantee is valid for the service life of the appliance.
3. It is a prerequisite of all warranty claims that the appliance with Aqua-Stop must have been set up and connected correctly in accordance with our instructions; this also includes a correctly fitted Aqua-Stop extension (original accessories).  
Our warranty goes not cover defective power cables or fittings between the Aqua-Stop connection and the tap.
4. Appliances with Aqua-Stop do not need to be supervised during operation, nor secured afterwards by turning off the tap.  
The tap only needs to be turned off if you are away from home for a long period, e.g. for several weeks' holiday.

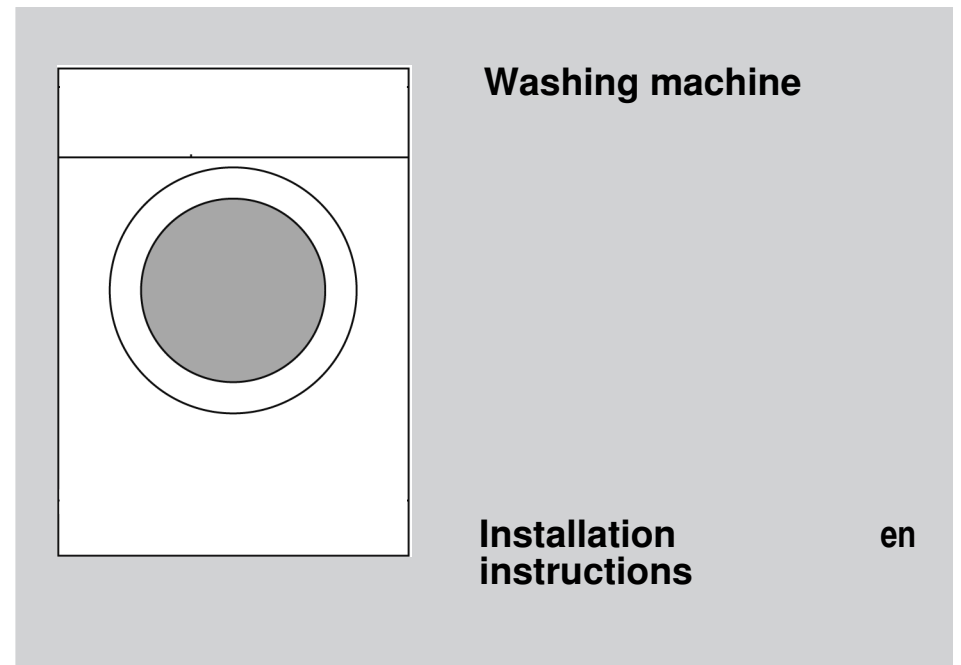

## Contents

	<i>Page</i>
■ Safety instructions . . . . .	1
■ Scope of delivery. . . . .	1
■ Installation surface. . . . .	1
■ Hose and cable lengths . . . . .	2
■ Installing the appliance . . . . .	2
■ Removing the transport braces . . . . .	3
■ Water connection . . . . .	4
■ Alignment . . . . .	5
■ Electrical connection . . . . .	5
■ Transportation, e.g. when moving home . . . . .	6
■ Technical specifications. . . . .	6
■ After-sales service . . . . .	7
■ Aqua-Stop warranty . . . . .	7



**Read these instructions before switching on the washing machine.  
Also observe the separate Instruction manual.  
Keep all documents for use in the future or for the subsequent owner.**