

Safety instructions

- The washing machine is heavy – caution when lifting it.
- Warning: Frozen hoses may tear/burst. Do not install washing machine in areas where there is a risk of frost and/or outdoors.
- Washing machine may be damaged. Do not lift by projecting components (e.g. washing machine door).
- In addition to the instructions mentioned here, special regulations of the relevant water and power supply companies may apply.
- If in doubt, have the appliance connected by a technician.
- Lay hoses and cables in such a way that there is no risk of stumbling.

Scope of delivery

according to model

Humidity in the drum is caused by the final inspection.

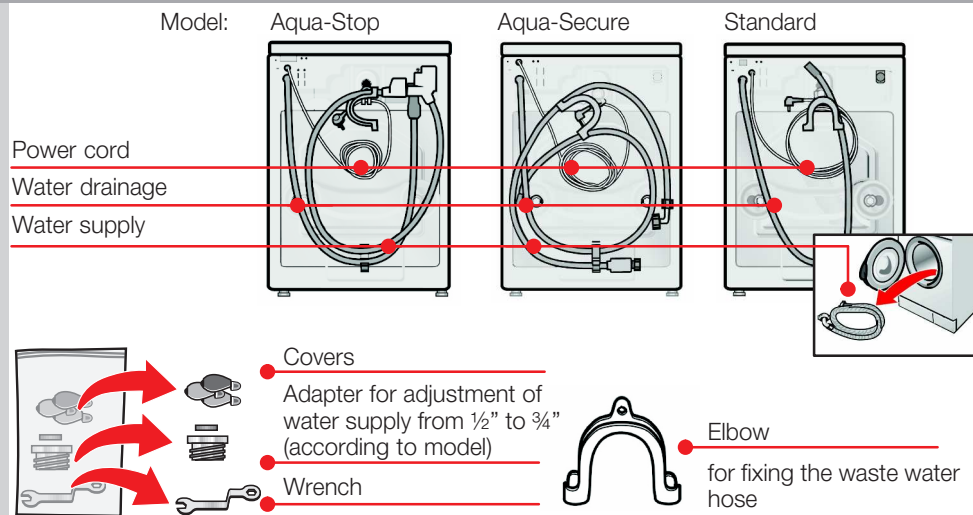

Depending on the connection

- 1 hose clip $\varnothing 24-40$ mm (specialist outlet) for connection of the siphon is also required.

Useful tool

- Spirit level for alignment.

Installation area

- Stability is important to prevent the machine from wandering!
- The installation area must be firm and level.
- Soft floors/floor coverings are not suitable.

If installing the appliance on a base

- Secure the washing machine feet with retention plates (* order no. WMZ 2200, WX 9756).

If installing the appliance on a wooden joist ceiling

- If possible, install the washing machine in a corner.
- Screw a water-resistant wooden panel (min. 30 mm thick) to the floor.
- Secure the washing machine feet with retention plates (*order no. see above).

1

Hose and cable lengths depending on model

Connection on left side or Connection on right side

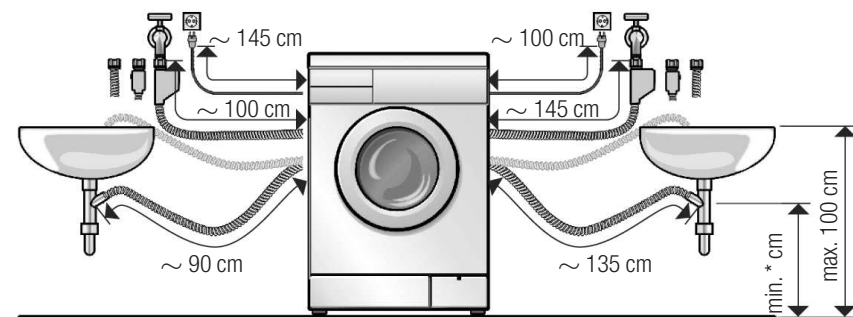

* Models Standard, Aqua-Secure min. 60 cm – max. 100 cm
Model Aqua-Stop 0 – max. 100 cm

Available from dealer/customer service:

- Aqua-Stop extension hose (approx. 2.50 m), order no. WMZ 2380, WZ 10130
- Longer supply hose (approx. 2.20 m), for standard model

Built-under/Built-in appliance

Build under/build in before connection to the power supply.

Installed in between kitchen units (built under or built in)

- 60 cm cavity width required.
- Install washing machine only under a continuous worktop connected firmly to the adjacent cupboards.

Built-under appliance

- 60 cm cavity width required.
- Instead of the appliance cover panel, have a technician install a sheet metal cover (* order no. WMZ 2340, WZ 10090).

2

Remove transportation protection devices

- Before using the appliance for the first time, remove all the transportation protection devices and retain for subsequent transportation of the appliance.
- Keep the bolt, washer and sleeve screwed together.

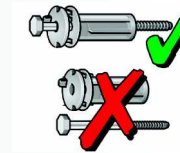

1. Take the hoses out of the holders and, depending on the model, remove the elbow.

2. Loosen the bolts (1, 2, 3)
... until they are freely movable in the sleeves.

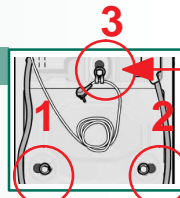

3. Completely remove the transportation protection devices (1, 2).
Remove each bolt together with the washer and sleeve.

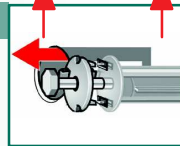

4. Completely remove transportation protection devices (3)
Bolt together with spring, washer and sleeve.
Tip:
Place one hand through the open washing machine door and pull the drum forwards slightly.

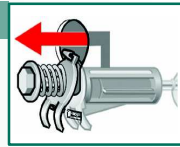

5. Insert covers

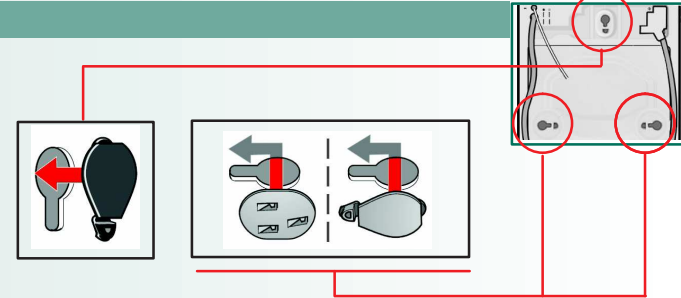

3

Water connection depending on model

- Risk of electric shock! Do not immerse Aqua-Stop safety device in water (contains an electric valve).
- To prevent leakage or water damage, follow the instructions in this chapter!
- Attention: Operate the washing machine with cold drinking water only. Do not connect to a mixer tap of a pressureless hot-water heater.
- If in doubt, have the appliance connected by a technician.

Water supply

Water supply hose:

Attention: Do not kink, crush, modify or sever water supply hose (strength is no longer guaranteed).

Optimum water pressure in the mains: 100–1000 kPa (1–10 bar)

- When the tap is turned on, the water flow is at least 8 l/min.
- If the water pressure is higher, install a pressure reducing valve.

1. Connect water supply hose to the tap.
Tighten plastic screw-fittings by hand only.

Model: Aqua-Stop Aqua-Secure Standard

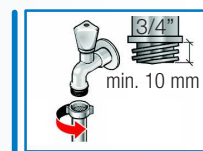
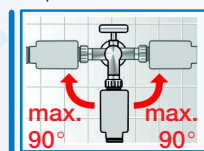

2. Open water tap carefully, checking the leak tightness of the connection points.
Attention: Screw fitting is under mains water pressure.

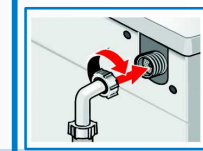

Water drainage

Water drainage hose:

Attention: Do not kink or protract the drainage hose.

Height difference between installation area and outlet:

- min. 60 cm – max. 100 cm for auqa-secure and standard models
- 0 – max. 100 cm for auqa-stop model

Drainage into a washbasin:

Attention: Secure the drainage hose from slipping out. Check that the water is pumped out quickly enough. Do not insert the end of the drainage hose into the pumped off water! There is a risk that water will be drawn back into the washing machine!

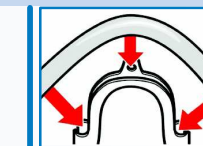

Drainage into a siphon:

Attention: Secure connection point with hose clip, $\varnothing 24-40$ mm (dealer).

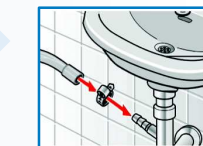

4

Alignment

 Loud noise formation, intense vibrations and "wandering" may be due to incorrect alignment!

Align washing machine with spirit level.

1. Loosen lock nut in a clockwise direction with a wrench.

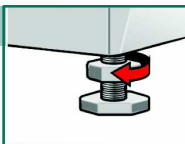

2. Change height by rotating the appliance feet. All four appliance feet must be firmly on the floor. The washing machine must not wobble! Check alignment of the washing machine with a spirit level and, if required, correct.

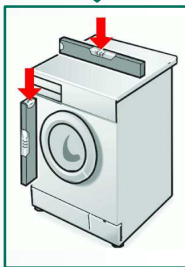

3. Tighten the lock nut against the housing.
– Grip the foot and do not adjust the height.
The lock nuts on all four appliance feet must be screwed tightly against the housing!



Electrical connection

● Connect the washing machine to an alternating current via a correctly installed earthed socket only.

● The mains voltage and voltage specifications on the washing machine (appliance rating plate) must match.

● Connected load as well as required fuse are indicated on the appliance rating plate.

● Ensure that:

- the mains plug and socket match,
- the cable cross-section is adequate,
- the earthing system has been installed correctly.

● A damaged power cord may be replaced by an electrician only. Replacement power cord available from customer service.

● Do not use multiple plugs/couplings or extension cables.

● If a residual current operated circuit-breaker is used, use only a type which features this symbol:  Only this symbol guarantees compliance with the currently valid regulations.

● Do not insert/pull out the plug with damp hands.
Do not pull out the mains plug by tugging the power cord.

Manufacturer (see Operating instructions)

0107 / 9000 085 786

Transportation, e.g. if moving house

After transporting and correctly installing and connecting the appliance, run the **Drain**  auxiliary programme before starting the first washing programme.

1. Before transporting the washing machine:

- 1.** Turn off the tap.
- 2.** Drain any residual detergent solution. See operating instructions, page 9; Detergent solution pump.
- 3.** Release the water pressure in the supply hose. See operating instructions, page 9; Filter in the water supply.
- 4.** Isolate the washing machine from the power supply.
- 5.** Remove the hoses.

2. Preparing and installing the transportation protection devices:

- 1.** Remove the two lower covers.
- 2.** Prepare transportation protection device:
 - Pull the bolt out of the sleeve until the end of the bolt is flush with the end of the sleeve.
 - Have a second person place his hand through the open washing machine door and pull the top of the drum forwards.
- 3.** Insert transportation protection devices 1 and 2.
- 4.** Tighten the bolts.
Insert the washer lug into the groove in the rear panel of the housing.

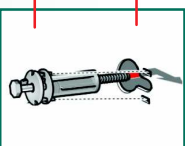
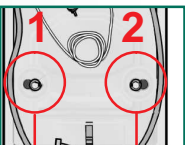

Technical specifications

Dimensions (width x depth x height)	60 x 59 x 84.2 cm
Weight	69–83 kg <i>depending on model</i>
Nominal voltage	220–240 V, 50 Hz
Mains connection	Socket (220–240 V, 50 Hz, min. 10A – LS-L switch)
Water pressure	100–1000 kPa (1–10 bar)
Test programmes according to EN 60 456 1999 and IEC 60456 Ed.3 1998: 02	

Customer service

● Before calling customer service, please check whether you can eliminate the fault yourself. See Operating instructions, page 10 «What to do if ...».

● If you require advice, even during the warranty period, you will incur costs for the call-out of a technician.

● You can find your nearest customer service in the enclosed list. Please give customer service the product number (E-Nr.) and the production number (FD) of the appliance.

E-Nr. _____ FD _____

Product number Production number

You can find the rating plate which contains this information in the frame of the open washing machine door and in the thick bordered box on the appliance rating plate at the back of the appliance.

● Please help by quoting the product number and production number to prevent unnecessary call-outs. This will save you additional costs.

Aqua-Stop warranty

For appliances with Aqua-Stop only

In addition to warranty claims against the seller based on the contract of sale and in addition to our appliance warranty we shall pay damages under the following conditions:

- 1.** If water damage was caused by a fault in our Aqua-Stop system, we shall compensate private users for damage.
- 2.** The liability warranty applies to the service life of the appliance.
- 3.** A claim can only be made under the warranty if the appliance and Aqua-Stop have been correctly installed and connected according to our instructions; this also includes a correctly installed Aqua-Stop extension (original accessory). Our warranty does not extend to defective supply lines or fittings up to the Aqua-Stop connection on the tap.
- 4.** Appliances which feature Aqua-Stop can be left unattended during operation and it is not necessary to turn off the tap afterwards. The tap should only be turned off if you are away for a prolonged period, e.g. several weeks holiday.



Contents

Page

■ Scope of delivery	1
■ Installation area	1
■ Hose and cable lengths	2
■ Built under and built in	2
■ Removing transportation safety devices	3
■ Water connection	4
■ Aligning the appliance	5
■ Electrical connection	5
■ Transportation, e.g. if moving house	6
■ Technical specifications	6
■ Customer service	7
■ Aqua-Stop warranty	7

 **Read these instructions before switching on the washing machine!**
Also follow the separate operating instructions.
Retain all documents for subsequent use or for the next owner.



Safety instructions

- The washing machine is heavy – caution when lifting it.
- Warning: Frozen hoses may tear/burst. Do not install washing machine in areas where there is a risk of frost and/or outdoors.
- Washing machine may be damaged. Do not lift by projecting components (e.g. washing machine door).
- In addition to the instructions mentioned here, special regulations of the relevant water and power supply companies may apply.
- If in doubt, have the appliance connected by a technician.
- Lay hoses and cables in such a way that there is no risk of stumbling.

Scope of delivery

according to model

Humidity in the drum is caused by the final inspection.

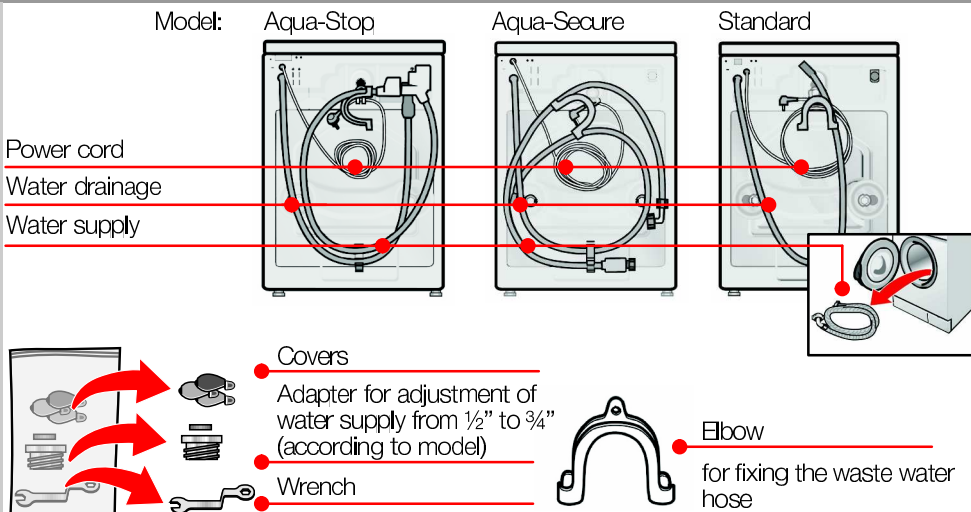

Depending on the connection

- 1 hose clip $\varnothing 24-40$ mm (specialist outlet) for connection of the siphon is also required.

Useful tool

- Spirit level for alignment.

Installation area



- Stability is important to prevent the machine from wandering!
- The installation area must be firm and level.
- Soft floors/floor coverings are not suitable.



If installing the appliance on a base

- Secure the washing machine feet with retention plates * (* order no. WMZ 2200, WX 9756).



If installing the appliance on a wooden joist ceiling

- If possible, install the washing machine in a corner.
- Screw a water-resistant wooden panel (min. 30 mm thick) to the floor.
- Secure the washing machine feet with retention plates * (*order no. see above).

Hose and cable lengths depending on model



Connection on left side

or

Connection on right side

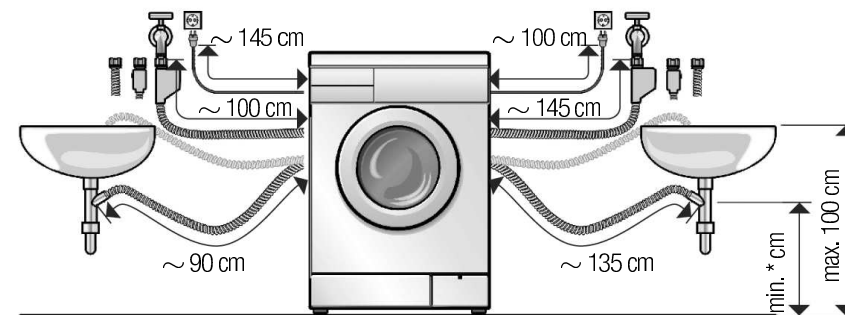

* Models Standard, Aqua-Secure min. 60 cm – max. 100 cm
Model Aqua-Stop 0 – max. 100 cm

Available from dealer/customer service:

- Aqua-Stop extension hose (approx. 2.50 m), order no. WMZ 2380, WZ 10130
- Longer supply hose (approx. 2.20 m), for standard model

Built-under/Built-in appliance

Build under/build in before connection to the power supply.



Installed in between kitchen units (built under or built in)

- 60 cm cavity width required.
- Install washing machine only under a continuous worktop connected firmly to the adjacent cupboards.



Built-under appliance

- 60 cm cavity width required.
- Instead of the appliance cover panel, have a technician install a sheet metal cover * (* order no. WMZ 2340, WZ 10090).

Remove transportation protection devices



- Before using the appliance for the first time, remove all the transportation protection devices and retain for subsequent transportation of the appliance.
- Keep the bolt, washer and sleeve screwed together.

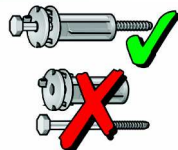

1. Take the hoses out of the holders and, depending on the model, remove the elbow.

2. Loosen the bolts (1, 2, 3)
... until they are freely movable in the sleeves.

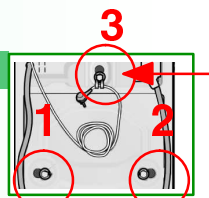

3. Completely remove the transportation protection devices (1, 2).
Remove each bolt together with the washer and sleeve.

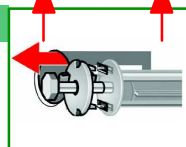

4. Completely remove transportation protection devices (3)
Bolt together with spring, washer and sleeve.
Tip:
Place one hand through the open washing machine door and pull the drum forwards slightly.

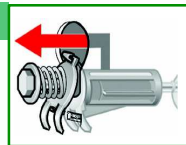

5. Insert covers

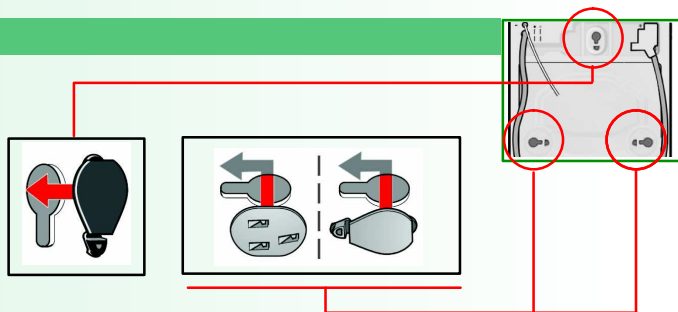

Water connection

depending on model



- Risk of electric shock! Do not immerse Aqua-Stop safety device in water (contains an electric valve).
- To prevent leakage or water damage, follow the instructions in this chapter!
- Attention: Operate the washing machine with cold drinking water only. Do not connect to a mixer tap of a pressureless hot-water heater.
- If in doubt, have the appliance connected by a technician.



Water supply

Water supply hose:

Attention: Do not kink, crush, modify or sever water supply hose (strength is no longer guaranteed).

Optimum water pressure in the mains: 100–1000 kPa (1–10 bar)

- When the tap is turned on, the water flow is at least 8 l/min.
- If the water pressure is higher, install a pressure reducing valve.

Model: Aqua-Stop Aqua-Secure Standard

1. Connect water supply hose to the tap.
Tighten plastic screw-fittings by hand only.

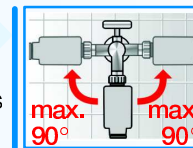

2. Open water tap carefully, checking the leak tightness of the connection points.
Attention: Screw fitting is under mains water pressure.

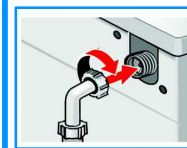
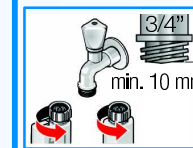

Water drainage

Water drainage hose:

Attention: Do not kink or protract the drainage hose.

Height difference between installation area and outlet:

- min. 60 cm – max. 100 cm for auqa-secure and standard models
- 0 – max. 100 cm for auqa-stop model

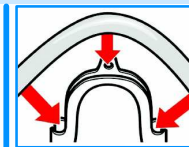

Drainage into a washbasin:

Attention: Secure the drainage hose from slipping out. Check that the water is pumped out quickly enough. Do not insert the end of the drainage hose into the pumped off water! There is a risk that water will be drawn back into the washing machine!



Drainage into a siphon:

Attention: Secure connection point with hose clip, Ø 24–40 mm (dealer).

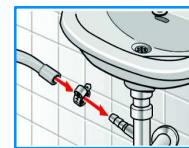

Alignment

 Loud noise formation, intense vibrations and "wandering" may be due to incorrect alignment!



Align washing machine with spirit level.

1. Loosen lock nut in a clockwise direction with a wrench.
2. Change height by rotating the appliance feet.
All four appliance feet must be firmly on the floor.
The washing machine must not wobble!
Check alignment of the washing machine with a spirit level and, if required, correct.
3. Tighten the lock nut against the housing.
– Grip the foot and do not adjust the height.
The lock nuts on all four appliance feet must be screwed tightly against the housing!

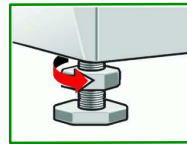
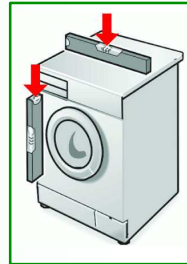
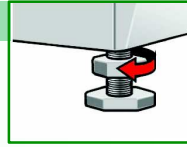

Electrical connection

- Connect the washing machine to an alternating current via a correctly installed earthed socket only.
- The mains voltage and voltage specifications on the washing machine (appliance rating plate) must match.
- Connected load as well as required fuse are indicated on the appliance rating plate.
- Ensure that:
 - the mains plug and socket match,
 - the cable cross-section is adequate,
 - the earthing system has been installed correctly.
- A damaged power cord may be replaced by an electrician only.
Replacement power cord available from customer service.
- Do not use multiple plugs/couplings or extension cables.
- If a residual current operated circuit-breaker is used, use only a type which features this symbol:  Only this symbol guarantees compliance with the currently valid regulations.
- Do not insert/pull out the plug with damp hands.
Do not pull out the mains plug by tugging the power cord.

Manufacturer (see Operating instructions)

0107 / 9000 085 786

Transportation, e.g. if moving house

After transporting and correctly installing and connecting the appliance, run the **Drain**  auxiliary programme before starting the first washing programme.

1. Before transporting the washing machine:

1. Turn off the tap.
2. Drain any residual detergent solution.
See operating instructions, page 9; Detergent solution pump.
3. Release the water pressure in the supply hose.
See operating instructions, page 9; Filter in the water supply.
4. Isolate the washing machine from the power supply.
5. Remove the hoses.

2. Preparing and installing the transportation protection devices:

1. Remove the two lower covers.
2. Prepare transportation protection device:
 - Pull the bolt out of the sleeve until the end of the bolt is flush with the end of the sleeve.
 - Have a second person place his hand through the open washing machine door and pull the top of the drum forwards.
3. Insert transportation protection devices 1 and 2.
4. Tighten the bolts.
Insert the washer lug into the groove in the rear panel of the housing.

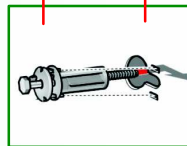
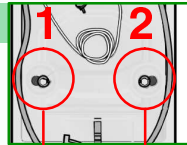

Technical specifications

Dimensions (width x depth x height)	60 x 59 x 84.2 cm
Weight	69–83 kg <i>depending on model</i>
Nominal voltage	220–240 V, 50 Hz
Mains connection	Socket (220–240 V, 50 Hz, min. 10A – LS-L switch)
Water pressure	100–1000 kPa (1–10 bar)
Test programmes according to EN 60 456 1999 and IEC 60456 Ed.3 1998: 02	

Customer service

- Before calling customer service, please check whether you can eliminate the fault yourself. See *Operating instructions, page 10* «What to do if ...».
- If you require advice, even during the warranty period, you will incur costs for the call-out of a technician.
- You can find your nearest customer service in the enclosed list. Please give customer service the product number (E-Nr.) and the production number (FD) of the appliance.

E-Nr. _____	FD _____
-------------	----------

Product number Production number

You can find the rating plate which contains this information in the frame of the open washing machine door and in the thick bordered box on the appliance rating plate at the back of the appliance.

- Please help by quoting the product number and production number to prevent unnecessary call-outs. This will save you additional costs.

Aqua-Stop warranty

For appliances with Aqua-Stop only

In addition to warranty claims against the seller based on the contract of sale and in addition to our appliance warranty we shall pay damages under the following conditions:

- 1.** If water damage was caused by a fault in our Aqua-Stop system, we shall compensate private users for damage.
- 2.** The liability warranty applies to the service life of the appliance.
- 3.** A claim can only be made under the warranty if the appliance and Aqua-Stop have been correctly installed and connected according to our instructions; this also includes a correctly installed Aqua-Stop extension (original accessory). Our warranty does not extend to defective supply lines or fittings up to the Aqua-Stop connection on the tap.
- 4.** Appliances which feature Aqua-Stop can be left unattended during operation and it is not necessary to turn off the tap afterwards. The tap should only be turned off if you are away for a prolonged period, e.g. several weeks holiday.



Contents

Page

■ Scope of delivery	1
■ Installation area	1
■ Hose and cable lengths	2
■ Built under and built in	2
■ Removing transportation safety devices	3
■ Water connection	4
■ Aligning the appliance	5
■ Electrical connection	5
■ Transportation, e.g. if moving house	6
■ Technical specifications	6
■ Customer service	7
■ Aqua-Stop warranty	7



Read these instructions before switching on the washing machine!
Also follow the separate operating instructions.
Retain all documents for subsequent use or for the next owner.