

Operating instructions and installation

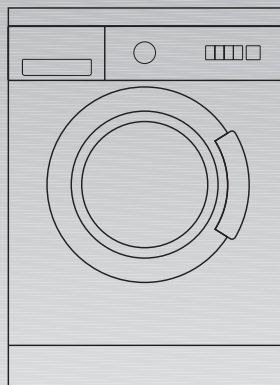

**Siwamat XB
1260**

Index

		Page
Points to remember	Notes on safety and general warnings	3
	Notes on the removal and disposal of packaging	4
	Protecting the environment / Hints on saving energy	4
Installation instructions	Removing the transport securing devices	5
	Installing the appliance	5
	Aligning the appliance	6
	Connecting to the water supply	7
	Appliance outlet	7
	Connecting to the power supply	8
Your new washing machine	Getting to know your new appliance	9
	Programme and spin speed selectors	10
	Washing machine status indicator lights	10
	Function and «Start» selection button	10
Notes on detergent / Preparing the laundry	Detergents and softeners	11
	Preparing the laundry	12
First washing cycle	First washing cycle	14
Wash	Washing / Opening the door / Loading the machine / Shutting the door	15
	Wash the laundry	16
	Wash programme end / Taking the laundry out of the machine	17
Cleaning Maintenance Frost protection	Cleaning/Maintenance/Frost protection	18
Malfunctions	Malfunctions with simple solutions	21
	After-Sales Service	22
	Technical data	23
	Consumption data	23

Notes on safety and general warnings

This appliance complies with the industry safety regulations.

Points to remember before putting the appliance into operation:

- ! Read the enclosed instructions before putting the appliance into operation. They contain important information and advice for installation, use and safety of the appliance.
- ! Keep the user documentation for the appliance so that later owners can use it.
- ! Install the appliance as described in the installation instructions. Remove the transport securing devices and keep them.
- ! If the appliance shows any sign of damage or imperfection it must not be connected to the power supply. If in doubt contact the After-sales Service or the Distributor that sold the appliance.
- ! A damaged power cable must be replaced with another special cable available from the Manufacturer's Customer Service.

Points to remember when washing clothes:

- ! The appliance must only be operated using cold water from the water mains.
- ! The appliance may only be used for items that may be washed in a domestic washing machine.
- ! Never leave children unsupervised with the appliance.
- ! Keep pets away from the appliance.

- ! Take care when pumping out hot water.
- ! **A flashing light does not indicate a fault. See the section: «Washing machine status indicator lights».**

Maintenance and care of the appliance:

- ! Do not climb onto the appliance.
- ! Do not use the door as a footrest or stand on it.

Points to remember when moving the machine:

- ! Fit the transport securing devices.
- ! Empty any remaining water from inside the appliance.
- ! Take care when moving the appliance Do not use the front components or controls on the appliance as a lifting aid.



Notes on the removal and disposal of packaging

Removal and disposal of packaging material for a new appliance

- ! Remove and dispose of packaging in accordance with current legislation.
- ! Packaging material is not a toy.

Reprocessing and reusing materials saves raw materials and reduces waste. All packaging material used is environmentally friendly and can be recycled or reused. The cardboard packaging consists of 80% to 100% recycled paper. The transparent protective film is polyethylene (PE) and the chlorofluorocarbon-free (CFC) moulded pieces are polystyrene foam (PS). These materials are made of pure hydrocarbons and can be recycled.

Disposal of an old appliance

- ! The old appliance must be made unusable before it is disposed of:
Disconnect from the mains power supply. Cut off the connecting cable and remove it together with the mains plug. Remove the door locks and fastenings or make them unusable so that children cannot shut themselves inside and suffocate.

Worn-out appliances contain valuable materials that can be recovered, if the appliance is taken to an official recyclable waste recovery centre (a public tip or recycling centre, for example). Actively contribute to the protection of the environment by ensuring that your old appliance is disposed of in a way that respects the environment.

Protecting the environment / Hints on saving energy

- The most economical and environmentally friendly way to use the machine is always to wash the maximum amount of laundry:
Cottons/coloureds
(hard-wearing fabrics) 5.00 kg / 11 lb
Synthetics 3.00 kg / 6.6 lb
Delicates and woollens 2.00 kg / 4.4 lb
- **How to save energy**
The variable capacity automatic system reduces the amount of water and energy consumed accordingly if the amount of laundry loaded into the machine is small. Select the «**Intensive Stains**» **60° C** programme instead of «**Cotton / Coloureds 90° C (hard-wearing fabrics)**». The program uses the longest wash cycle to reduce energy consumption whilst achieving the same results as washing at 90° C.
- **How to save water, energy and detergent:** Omit the prewash programme for lightly or normally soiled laundry.
- **How to save energy and time:** Select the short programme suitable for the fabric if items are lightly soiled.
- **How to save detergent:** Measure the detergent according to the water hardness, degree of soiling and amount of laundry, and follow the instructions on the detergent package.

Removing the transport securing devices

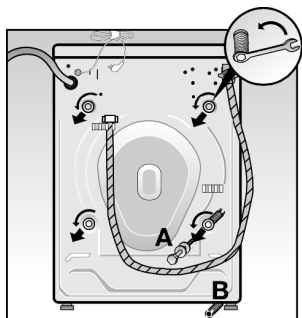

! Remove all the transport securing devices from the back of the machine before starting the appliance for the first time.

! **Caution.** Risk of injury through slipping.

- Loosen and remove the 4 fastening bolts «A», the tie bar (depending on model) and the seal.
- Next remove the four spacers «B» which will have fallen to the floor. Gently tilt the appliance forward.
- Fit the protective covers «C» which are in the bag accompanying the appliance documentation.

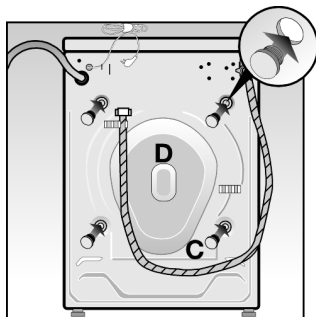

! Keep the transport securing devices in case you need to move the appliance in future.

The appliance should only be moved with the transport securing devices in place. To fit them, remove the back panel «D» from the appliance and carry out the operations given above in reverse order.

Installing the appliance

! When installing the appliance and connecting the water and electricity supplies, the following should all be to hand: safety instructions, warnings, general advice and information, and standards or requirements from water and electricity suppliers.

! Take care when lifting the appliance. **Risk of injury.**

! Do not lift the appliance by the controls or protruding components.

! If you are in any doubt, commission a qualified person to connect the appliance to the water and electricity supplies.

All appliances are rigorously tested at the factory under normal working conditions. The appliance or the outlet hose may still be damp or contain residual water as a result of these tests.

Installing the unit

The appliance must be placed on a firm flat surface to ensure that it is stable during spinning. Soft floor coverings, such as carpets or foam-backed flooring are not suitable surfaces for installation.

- ! If you have a **wooden joist** floor, the appliance must be placed on a water-resistant wooden board, 30 mm thick. It must be screwed to the floor. The appliance should be installed in a corner of the room if possible. Secure the appliance to the floor using fastening brackets fitted to the machine's feet (especially if the machine is a combined washer/dryer).
- ! If the machine is placed on a pedestal or raised base, the feet must be fixed using brackets to prevent the machine from shifting during the spin cycle.

The fastening brackets are available as a spare parts set from your specialist distributor.

Aligning the appliance

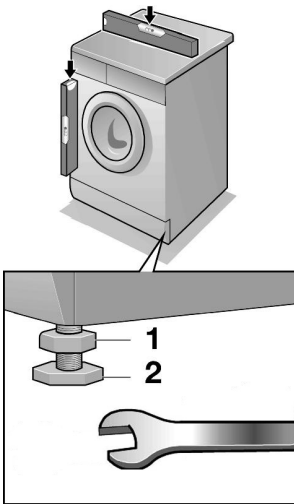

- ! The appliance must sit firmly and horizontally on the four feet without rocking.
- Use a spirit level to ensure that all four sides of the appliance are level.

Correct any imbalance by adjusting the height of the feet.

- Loosen the locknuts.
- Adjust the height of the feet.
- Tighten the locknuts securely so that the height set is retained.

Connecting to the water supply

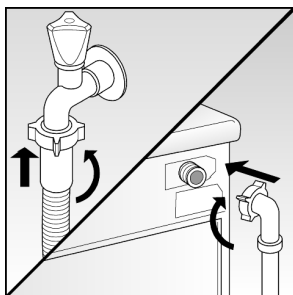

A pipe or standard domestic fresh-water hose is required for the water supply (included), with a minimum pressure of 1 bar (water must flow at a rate of approximately 8 litres per minute with the tap fully open).

If the pressure is higher than 10 bar, a pressure reducing valve must be inserted between the appliance and the water supply.

- ! Never connect the appliance to the mixer tap of an unpressurized water heater. If in doubt have connections made by a qualified technician.
- ! **Caution.** Connections between the appliance and the water supply must be able to withstand the full water pressure. Check the ring seal with the tap fully open.
- ! Remove the filter located at the end of the solenoid valve only when it needs cleaning. The other filter, located at the end of the pipe inside the plastic locknut which screws onto tap, should be cleaned in its tube (it cannot be removed).
- ! To avoid damage caused by leaks and flooding, the tap should always be closed after the appliance has completed a cycle and especially during long absences.
- ! Hand-tighten the plastic hose connection locknuts.

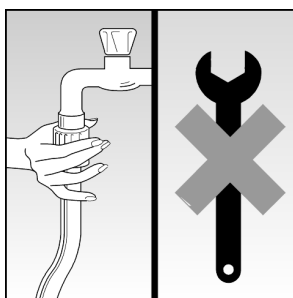

Appliance outlet

- ! Take care when fitting and connecting the appliance to the water outlet system that the hose is not bent or twisted. Do not pull on the hose.

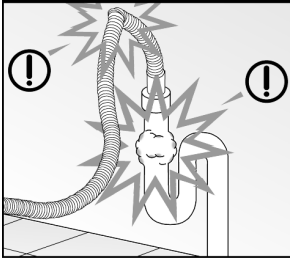
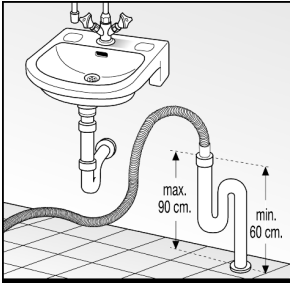

- ! If the water is discharged via a sink, ensure that the outlet hose cannot be dislodged. Check also that the water drains away quickly enough. Ensure that the sink plug is not preventing drainage. **Risk of flooding.**

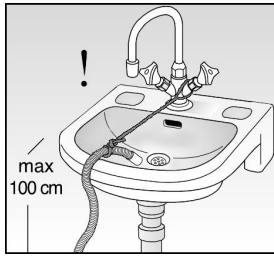

Connecting to the power supply

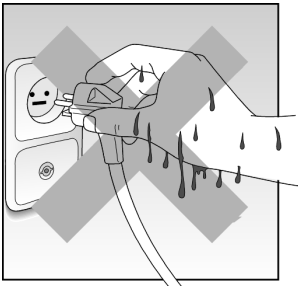
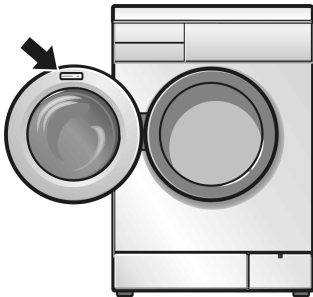

- ! The appliance must only be connected to an A.C. mains supply via a correctly installed earthed socket.
- ! The voltage given on the appliance nameplate must match that of the power supply where the appliance is installed.
- ! The power rating and the fuse or circuit breaker required are given on the appliance nameplate.
- ! Check that the socket and the plug on the machine are compatible, that the cables have a sufficient diameter and that it is earthed correctly.
- ! Never use multiple plugs, sockets or connectors or extension cables.
- ! If using a residual current–operated circuit breaker, it must display the  symbol. Only this type of protective switch will ensure compliance with current regulations.
- ! Remove the appliance plug from the socket, holding onto the body of the plug.
- ! In order to fulfil the safety regulations, the plug of the appliance must be accessible for the user; if this cannot be guaranteed, there must be incorporated in the fixed wiring a means for disconnection from the supply having a contact separation of at least 3 mm in all poles

Getting to know your new appliance

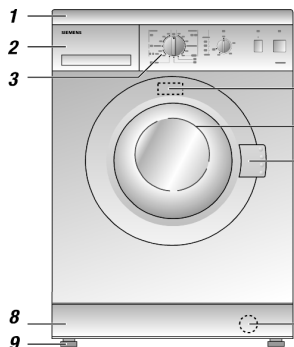

1. Protective plate (Lid).
2. Detergent and softener drawer.
3. Control panel (printed keys, symbols or full text, depending on model of appliance).
4. Nameplate.
5. Door.
6. Door opener.
7. Outlet pump (water outlet filter) behind the base board.
8. Base board
9. Height adjustable feet for aligning the appliance.

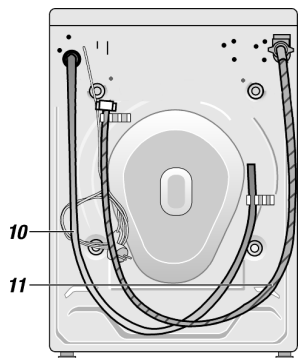

(According to model of appliance)

10. Water outlet pipe.
11. Water inlet pipe.
12. Programme selector.
13. Washing machine status indicator lights.
14. Selector for spin speed.
15. «Extra rinsing» button.
16. «Start» button.

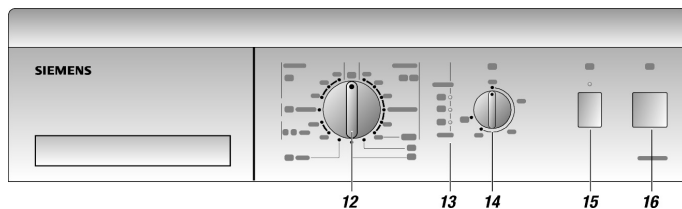

Programme and spin speed selectors

The **programme selector** is used to select and adjust programmes. Turn the selector clockwise (to the right). Align the setting mark with the programme required.

Caution. The selector cannot be turned mid-programme. It remains fixed in the position selected.

The **spin speed selector** can be used to select the preferred spin speed in continuous mode or the «No Final Spin» option.

The maximum spin speed is automatically limited in the «Synthetics» (delicate fabrics) washing programmes to ensure that the laundry is washed carefully. «Very delicate» and «Woollens».

«**No Final Spin**» option: The laundry remains in the water after the final rinse to avoid creasing the fabric.

Washing machine status indicator lights

The «**Wash/Ready**» indicator light flashes when the required programme has been selected. This indicator light remains lit when the «Start» button is pressed and the programme begins.

The «**Rinse**» indicator light comes on (set) during the rinse programme.

While the washing machine is spinning and emptying out the water, the «**Spin/End**» indicator light remains lit. The indicator light flashes when the programme is completed. To turn the machine off, set the programme selector to «Off»

Function and «Start» selection button

Start

The appliance starts the programme selected when the button is pressed. The «Wash/Ready» indicator light comes on. Preselect the wash programme.

Caution: To prevent damage to the appliance do not start the machine if the door is not properly shut, even if the «Wash/Ready» indicator light is on and the «Start» button is depressed.

The door of the washing machine cannot be opened during the washing cycle. The machine must first be switched off before the door can be opened (programme selector on «Off»). Check that the «Spin/End» indicator light has gone out. The door can be opened after 2 minutes.

Extra rinsing

When this button is pressed, the function indicator light comes on and the programme carries out an extra rinsing cycle to completely remove any remaining detergent. Recommended for rinsing delicate fabrics, net curtains, etc.

Detergents and softeners

You can use all powder and liquid detergents suitable for front-loading washing machines.

- ! Do not use hand washing detergents because they produce too much foam.
- ! Do not use solvent-based detergents in automatic washing machines. **Risk of explosion.**
- ! Do not use washing performance enhancers, stain removers or sprays near the machine as they could damage the machine.
- ! Store detergents and additives in a safe place out of the reach of children.

Detergent quantity

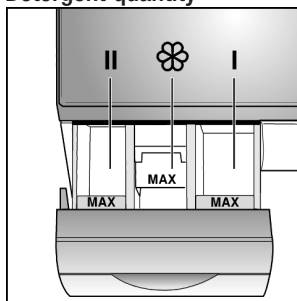

Only the correct dosage of detergent ensures good washing results. Follow the instructions on the detergent packaging. Use the dispenser provided with the packaging, such as a detergent ball or sachet, for liquid detergent.

Never exceed the maximum mark on the dispenser.

The quantity of detergent required depends on:

- the water hardness.
- the degree of soiling.
- the amount of washing.
- the dosage recommended for the type of detergent.

Insufficient detergent will not be noticed until the laundry has been washed several times in the same way:

- The laundry turns grey or is not clean.
- Greyish brown spots may form on the laundry.
- Lime scale may start to form on the appliance heating elements.

An excessive amount of detergent may cause:

- Unnecessary environmental pollution.
- Slower washing movement in the machine due to the formation of foam leading to poor washing results.

The detergent dosage given on the packaging is based on a full washing machine load.

The quantity of detergent should be reduced for smaller loads or laundry that is lightly soiled.

Hints

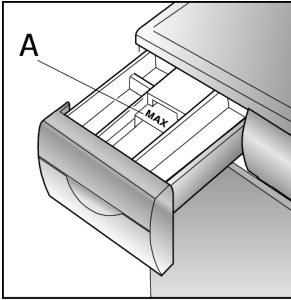

Fabric softeners

Put the fabric softener in the chamber marked ☼. Do not exceed the «MAX» marking (maximum to the lower edge of the piece **A**) because the softener will be flushed into the water with the detergent at the start of the washing cycle and so have no effect in the fabric softening cycle. Thicker fabric softeners should first be diluted with a little water.

Bleaching agents, stain removers

Powdered bleaching agents and stain removers can be added. First put the detergent in the drawer. Next add the powdered bleaching agent or stain remover to the **II** chamber.

Preparing the laundry

Sorting the laundry

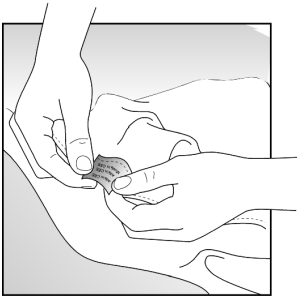

- Sort the laundry according to the symbols on the labels.

! Items made of or containing, wool must have «Will not shrink» or «Machine washable» on the label. Otherwise there is a risk of the wool shrinking.

Only items displaying the following symbols should be machine washed:

Hard-wearing white fabrics



Coloured fabrics (hard-wearing colour-fast fabrics)



Delicate items and coloured fabrics



Very delicate items



Hand washable or machine washable at 30°C, wool, cold



Items showing the following symbols should not be washed in the machine:

Do not wash in the machine 

- Sort the laundry into colours. Wash white and coloured items separately, otherwise whites may take on colour.
- ! Any new coloured items should be washed separately. **Risk of discolouration.**
- Sort the laundry according to the maximum permitted load for the machine. Do not overload the machine. Overloading the machine leads to poor washing results.

Maximum washing loads permitted:

Soiled or very soiled hard-wearing white laundry/Colourfast and hard-wearing laundry	5.0 kg / 11 lb
Synthetics	3.0 kg / 6.6 lb
Delicates and woollens	2.0 kg / 4.4 lb

Practical advice

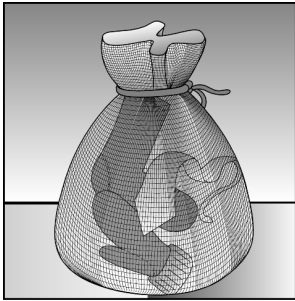
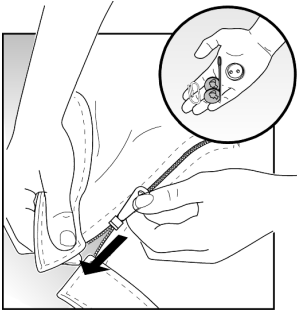

Removing stains

- Remove all foreign material and metal objects from the items, for example, safety pins, fasteners, clips, etc.
 - Brush sand out of pockets, cuffs and turnups.
 - Close zips and fasten buttons on duvet covers and pillow cases.
 - Remove curtain hooks or tie in a net or bag.
 - Wash particularly delicate items, such as tights or lace curtains, and small items, such as socks and handkerchieves, in a net, pillow case or cushion cover.
 - Turn trousers and knitted items (for example knitwear, T-shirts, sweatshirts, etc.) inside out.
 - Ensure that fasteners with inserts (hoops, etc.) can be washed in a machine.
- ! Place items with inserts in a pillowcase, for example, to prevent them from becoming detached during washing and falling through the perforations in the drum, causing damage to the machine.

If possible, stains should be treated or removed as soon as they occur.

Try first with soap and water. Do not rub the material. Dried on stains will only be removed after several washes.

First washing cycle

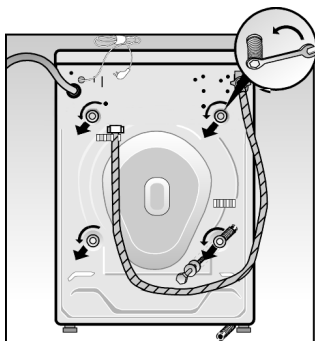

Carry out the first wash **without any laundry in the machine** to remove residual water left from testing the machine at the factory.

- Check that the transport security devices have been removed from at the back of the machine (refer to the removal instructions for the machine).
- Open the water tap.
- Open the detergent drawer as far as it will go.
- Pour approximately one litre of water into chamber II of the drawer
- Put standard detergent in chamber II using the measuring cup. Never use detergent for delicate or woollen items because it produces too much foam.
- Turn the programme selector to the «**Cottons/Coloureds 90° C**» programme. The «Wash/Ready» indicator light flashes.
- Press the «Start» button. The programme starts and the «Wash/Ready» indicator light stays on.
- When the programme has finished, the «Spin/End» indicator light starts flashing. Set the programme selector to «Off» and the light goes out.

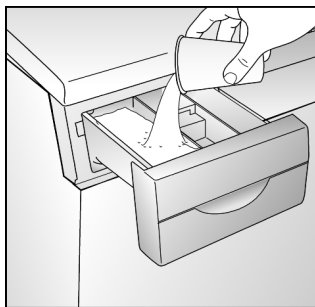
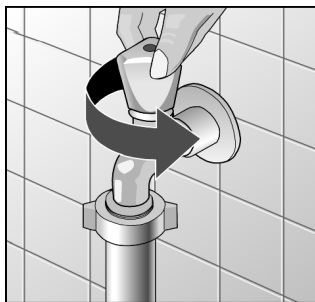

Washing / Opening the door / Loading the machine / Shutting the door

Opening the door

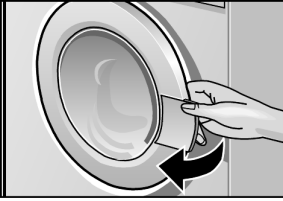

- Pull the door catch towards you.

Put the laundry in the washing machine

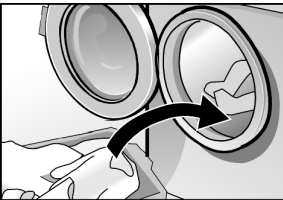

- ! Items which have been pre-treated with detergents containing solvents, for example stain removers, cleaning fluids, etc., should be left to dry in the open air before washing. **Risk of explosion.**
- ! Check that there are no foreign bodies or animals inside the drum before putting the washing in.
- Place the laundry loosely and unfolded in the drum. Mix large and small items.

Shutting the door

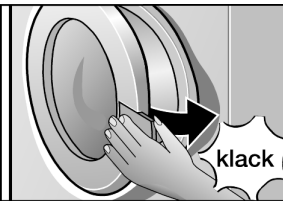

- ! Shut the door, taking care to ensure that no items are trapped between the door and the rubber seal.
- Shut the door pressing it against the door frame until the door lock can be heard to engage.

Adding the detergent and turning the tap on

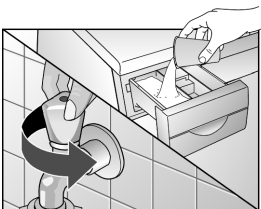

- Put detergent in chamber **II** of the drawer.
Do not exceed the maximum mark.
- Chamber **I**: Prewash detergent.
- Chamber **II**: Main wash detergent, water softener, starch, bleach and stain remover.
- Chamber ☼: Additives for the final rinse, for example fabric softeners.
- Turn the tap on.

Wash the laundry

Selecting a wash programme

Basic wash programmes

See the programme table below

«Cottons/Coloureds»

Heavily soiled whites, 90 °C

Intensive wash programme for hard-wearing cotton or linen items.

Intensive Stains, 60 °C

Energy-saving programme. The longest washing cycle reduces energy consumption.

Whites and coloureds, hard-wearing fabrics and colourfast, 60 °C, with pre-wash – +

For highly soiled laundry.

Coloureds, 30, 40, 60 °C

Hard-wearing fabrics.

«Easy-Care»

Delicates, 30, 40, 60 °C (synthetics)

For washing delicate cottons, synthetic or mixed fibre fabrics.

«Delicates»

Very delicate items, 30 °C (gentle wash programme)

For washing delicate cottons, synthetic or mixed fibre fabrics, or curtains. These programmes have no spin cycle between rinsing cycles.

«Wool»

Woollens, 30 °C, cold

For machine washable woollens or wool mixtures.

Additional programmes

Rinse

Rinse cycle with low-energy spin. Can also be used for delicate items.

Spin

Extra spin cycle, washing or rinsing water is pumped out before spinning the laundry.

Empty

Pumps out the rinse water if «No Final Spin» has been selected. For careful washing of delicate items.

«No Final Spin»: Option may be selected using the spin speed selector. The laundry remains in the last rinsing water to avoid creasing.

Additional functions

Extra rinsing

The programme carries out an extra rinse cycle.

Starting a programme

- Turn the programme selector to the required wash programme.
- The «Wash/Ready» indicator light flashes.
- Selecting the required spin speed or «No Final Spin» option. Ensures careful washing by automatically limiting the maximum spin speed in the «Delicates (synthetics)», «Very delicate» and «Woollens» wash programmes.
- Press the additional function button(s) to activate them. The corresponding indicator light comes on.
- Press the «Start» button. The «Wash/Ready » indicator light comes on. The wash programme starts. The «Wash/Ready» indicator light remains lit throughout the wash programme selected.
- The «Rinse» indicator light comes on during the «Rinse» programme.

Modifying a selected programme

If you have selected and started an incorrect wash programme it can be corrected in the following way:

- Turn the programme selector to «Off».
- Set the programme selector to the position for the required programme. The «Wash/Ready» indicator light flashes.
- Press the «Start» button
The «Wash/Ready» indicator light comes on. The newly selected programme starts.

Interrupting a wash programme

If you should wish to stop a programme already in progress:

- Turn the programme selector to «Off».
- Turn the programme selector to the «Empty» or «Spin » programme position. The «Spin/End» indicator light flashes.

If selecting the «Spin» function, adjust the required spin speed (do not select the «No Final Spin» option.):

- Press the «Start» button.
The «Spin/End» indicator light comes on.

Wash programme end / Taking the laundry out of the machine

The «Spin/End» indicator light flashes.

- Turn the programme selector to «Off».

If necessary:

- Select an additional programme («Empty», «Spin» or «Rinse»).
- Press the «Start» button.
- When the additional programme selected has finished, turn the programme selector to «Off».

Taking the laundry out of the machine

- Close the tap.
- Open the door.
If the door cannot be opened:
Wait 2 minutes (the machine's safety device is activated)
or:
If the «No Final Spin» option was selected, there will still be water inside the appliance. Select an additional programme («Empty» or «Spin») to pump out the water.
- Take the laundry out of the machine.
- ! Remove any foreign material or metal objects (clips, fasteners, money, etc.) which may have collected in the drum or rubber seal. **Risk of rusting.**

Leave the door open so that air can circulate inside and dry the appliance.

Cleaning the outside of the appliance

! **Disconnect the appliance from the mains and shut off the water supply before carrying out any maintenance work.**

! Do not use solvents. These products can damage the washing machine's components, produce noxious fumes and may cause an explosion.

! Do not clean the appliance with a water jet.

Clean the body of the appliance and the controls with lukewarm soapy water or a standard cleaning agent only. Do not use scouring products. Dry it with a soft cloth.

Cleaning the detergent drawer

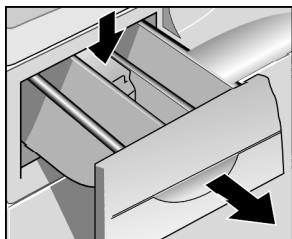

1. Remove the drawer from the appliance. Disengage it by pressing down on the tab at the back of the drawer in the fabric softener section. Hold the tab down and pull the drawer out of the appliance.
2. Clean all the parts and components under running water.
3. Replace the drawer.

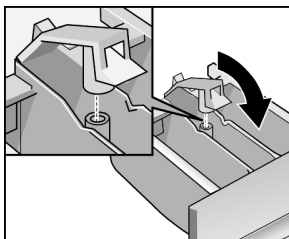
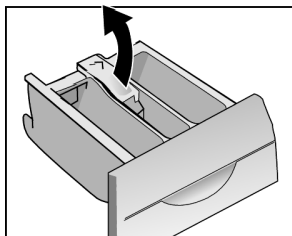

Descaling the appliance

Descaling is not normally necessary if the correct dosage of detergent has been used.

! Descaling agents contain acids which may attack the components and insides of the appliance or cause discolouration in the laundry.

If you wish to descale the machine anyway, follow the manufacturer's instructions closely.

Cleaning the drum

Rust stains should be cleaned using chlorine-free detergents (look at the list of substances contained in the product on the packaging.) Never use wire wool.

Water inlet hose

It is recommended that the condition of the hose be checked every 5 years to prevent the risk of damage caused by leaks or flooding.

Cleaning the water pump

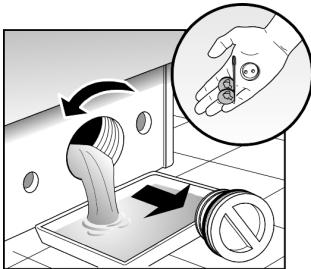
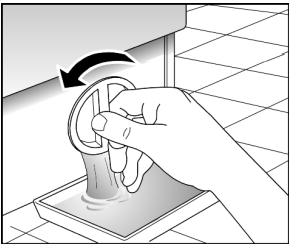
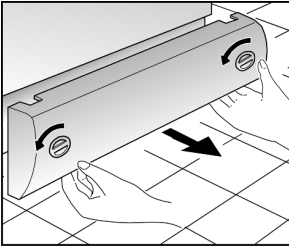

Cleaning is necessary:

- If the pump is blocked by foreign material (for example buttons, fasteners, clips, etc.) or if used water is not drained.
- After washing fluffy items.

All water must be removed from inside the appliance before cleaning the pump. As much as 20 litres / 4.4 gal of water may remain if the pump is obstructed.

Procedure

1. Remove the base board from the front of the washing machine, turning the plastic screw heads using a coin.

! **Risk of burning.** Allow the used water to cool down

2. Place a shallow container under the drainage pump cover (outlet filter). Loosen the cover without removing it completely to allow the water to empty gradually. Close the drainage pump cover when the container is full. Repeat the operation until all the water has been emptied. Use a suitable container to remove any remaining water which may spill on the floor.
3. Loosen the drainage pump cover completely.
4. Remove any foreign material or fluff which may have collected there. Wipe the inside of the pump. The blades must move freely.
5. Loosen and fit the drainage pump cover in place. Ensure that it is correctly closed.
6. Fit the base board in place.
7. Pour 2 litres / 3.5 pt of water into the detergent drawer and start the «Empty» additional programme. This will prevent the detergent from being flushed out before being used in the next wash.

Wiping the appliance's water inlet filters

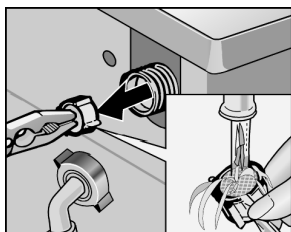
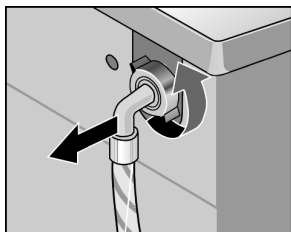
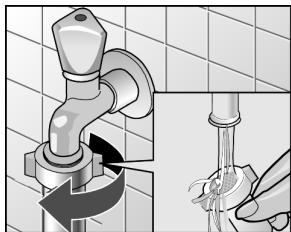

The appliance's water inlet filters must be cleaned with the tap is open and no water flowing into the appliance. The filters are located in the hose connection joining the water supply pipe to the domestic water supply, and in the solenoid valve connection at the back of the machine.

Procedure

1. First let the water pressure out of the supply pipe:
 - Close the tap.
 - Turn the programme selector to any wash programme (except «Spin» or «Empty»)
 - Press the «Start» button. Allow the machine to operate for 40 seconds.
 - Turn the selector to «Off».
2. Loosen the supply pipe from the tap. Rinse the filter under running water.
3. Reconnect the pipe to the tap fitting.
4. Remove the water supply hose from its connection on the back of the appliance.
5. Remove the filter using flat pliers; wipe it and replace it.
6. Tighten and fit the pipe on its coupling.
7. Open the tap and check that there are no water leaks.
8. Close the tap.

If the machine has been installed in an area where it is not protected against low temperatures, residual water must be removed from the pump and the fresh-water hose after each wash cycle.

Frost protection

Empty the water from the water inlet hose:

1. Close the tap.
2. Loosen the supply pipe from the tap. Place the end of the hose in a container.
3. Select any wash programme for 40 seconds. Any water remaining in the hose is drained.
4. Reconnect the pipe to the closed tap.

Empty the water from the pump:

See the «Cleaning the pump» section.

Malfunctions with simple solutions

! Repairs to electrical appliances must only be carried out by qualified specialists. Repairs carried out incorrectly can be dangerous.

Malfunction	Possible cause / Remedy
The On/Off light does not come on	<ul style="list-style-type: none">– The appliance plug is not inserted in the socket or not fully inserted in the socket.– The fuse has blown.– Electrical power failure.
Electrical power failure	In the event of a power failure or appliance malfunction, emergency draining is possible (refer to the «Cleaning the discharge pump» section, so that the laundry can be removed from the machine).
The wash cycle does not start	The «Start» button is not depressed. The door is not closed.
Machine does not fill with water	This is not a malfunction. The water remains below the visible area in the machine.
Washing result is unsatisfactory	Abnormally high degree of soiling. Insufficient detergent. Measure the detergent according to the manufacturer's instructions. Select the most appropriate temperature and wash programme for the laundry.
Foam comes out of the detergent drawer	Too much detergent was used. Switch the machine off for 5 - 10 minutes. Prevent foam building up by putting a tablespoon of fabric softener and half a litre / 1 pt of water into the detergent drawer. Reduce the detergent dosage in the next wash.
Foam is visible after the final rinse	Some detergents produce a large quantity of foam although this has no effect on the rinsing result.
Unexpected motor noises	This is not a malfunction. During the heating stage, the motor produces noises characteristic of starting.
Pump noises	This is not a malfunction. These noises are characteristic of the machine starting and the pump discharging.
The machine vibrates when washing or spinning	The transport securing devices have not been removed. See the machine installation instructions. The adjustable feet on the machine were not fixed during installation of the appliance. Align the machine using a spirit level and fix the feet as indicated in the installation instructions.
The appliance does not spin or drain the used water.	The outlet pump is blocked. The outlet pipe is bent or blocked.
The door does not open	The safety device is activated. The «No Final Spin» option has been selected.
The machine does not fill with water	The tap is closed. The water inlet filters are dirty.

- Before calling the After-Sales Service, check whether you can solve the problem yourself. (See the «Problems with simple solutions» section).
This will avoid unnecessary cost as technical expenses are not covered by the warranty.
- ! If a malfunction occurs despite following the instructions given above, disconnect the appliance, pull the plug out of the socket and close the tap, then contact the After-sales Service.

If requesting the assistance of the After-sales Service, remember to give the product number (**E-Nr.**) and the production number (**FD**). Both numbers are located on the nameplate, located inside the door frame of the door and on the plate located behind the base board on the front of the machine at the bottom.

Note the numbers of your machine here

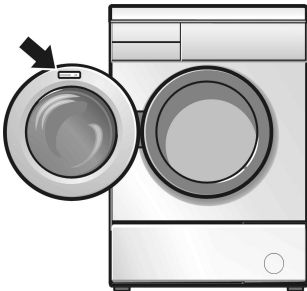

E-Nr. _____	FD _____
--------------------	-----------------

Product number

Production number

Giving the correct product and production numbers helps to avoid wasted journeys for our technicians. Which will save you unnecessary expense.

Technical data

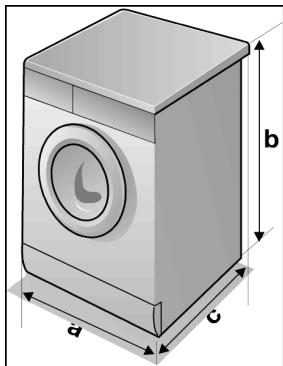

a – Width	59,5 cm
b – Height	85,0 cm
c – Depth	56 cm
Weight	approx. 70 kg
Drum capacity	according to the nameplate
Voltage	
Fuse	
Water pressure	

Consumption data

Programme	Size of load	Consumption **		
		Current	Water	Duration
Coloureds 40° C	5,00 kg*	0,60 kWh	54 l	118 min
Coloureds 60° C	5,00 kg	0,86 kWh	54 l	118 min
Coloureds 60° C extra	5,00 kg*	0,95 kWh	49 l	140 min
Whites 90°C	5,00 kg	1,70 kWh	61 l	118 min
Delicates 40°C	3,00 kg*	0,40 kWh	50 l	75 min
Very delicate 30°C	2,00 kg	0,30 kWh	55 l	50 min
Woolens 30°C	2,00 kg*	0,20 kWh	35 l	60 min

* Test programmes in accordance with EN 60456: 1999 e IEC 456 Ed. 3 1998: 02

** The consumption values provided in the table above are indicative only and may vary according to pressure, water hardness and temperature, the ambient temperature where the appliance has been installed, the type and size of load, the detergent used, fluctuations in mains voltage and the additional functions selected.

