

SIEMENS

Making cooking as much fun as eating

Please read this instruction manual. This will ensure that you make use of all the technical benefits the cooker has to offer. You will be given important safety information. You will then be introduced to the individual components of your new cooker and we will show you how to adjust it step by step. It is quite simple.

The tables list the settings and shelf heights for numerous well-known dishes. All these dishes are tested in our cooking studio.

In the unlikely event of a fault, look here for information on how to rectify minor faults yourself.

A detailed table of contents will help you to find your way around quickly.

Enjoy your meal!

Instruction manual

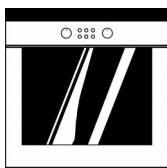

HB 76L.50 B
HB 76R.50 B

en

9000 011 334

Table of contents

Important information	5
Before installation	5
Safety information	5
Reasons for damage	7
Your new cooker	8
The control panel	8
Function selector	9
Rotary knob	9
Control buttons and display panel	10
Push-in control knobs	10
Types of heating	11
Oven and shelving accessories	13
Cooling fan	16
Before using for the first time	16
Heating up the oven	17
Pre-cleaning the accessories	17
Setting the oven	17
Setting procedure	18
If the oven is to switch off automatically	19
If the oven is to switch on and off automatically	20
Residual heatindicator	21
Rapid heating	21
Setting procedure	21
Automatic roasting	22
Ovenware	22
Preparing food	23

Table of contents

Programs	24
How long will the meal take to cook?	25
Setting procedure	26
The oven will switch on and off automatically	27
Tips for automatic roasting	28
Sabbath setting	29
Setting procedure	29
Time	30
Setting procedure	30
Timer	31
Setting procedure	31
Basic settings	32
Changing the basic settings	33
Childproof lock	34
Automatic time limiter	34
Automatic self-cleaning	35
Setting procedure	36
Self-cleaning should switch on and off automatically	37
When the oven has cooled	38
Care and cleaning	38
Oven exterior	38
Oven	39
Cleaning the glass panels	40
Seal	41
Steam filter	42
Accessories	42

Table of contents

Troubleshooting	43
Replacing the oven light	44
After-sales service	45
Packaging and old appliances	45
Tables and tips	46
Cakes and pastries	46
Baking tips	49
Meat, poultry, fish	50
Tips for roasting and grilling	52
Frozen foods	52
Defrosting	53
Drying	54
Preserving	54
Energy saving tips	56
Acrylamide in food	57
What can you do?	58
Test dishes	59

Important information

Read this instruction manual carefully. Only then will you be able to operate your cooker safely and correctly.

Please keep the instruction and installation manual in a safe place. Please pass on the instruction manual to the new owner if you sell the appliance.

Before installation

Transport damage

Check the appliance after unpacking it. Do not connect the appliance if it has been damaged in transport.

Electrical connection

The cooker may only be connected by an approved specialist. Losses resulting from damage caused by incorrect connection will invalidate warranty claims.

Safety information

Hot oven



This appliance is intended for domestic use only. Only use the cooker for food preparation.

Open the oven door carefully. Hot steam may escape. Never touch the internal surfaces of the oven or the heating elements. There is a risk of burning. Children must be kept at a safe distance from the appliance.

Never store combustible items in the oven. Risk of fire

Never clamp leads of electrical appliances in the hot oven door. The insulation on the leads could melt. There is a risk of short-circuiting.

Repairs



Incorrectly done repairs are dangerous. There is a risk of electrocution.

Repairs may only be carried out by after-sales service technicians who have been fully trained by BSH.

If there is a fault, switch off the oven fuse at the fuse box.

Call the after-sales service.

Automatic self-cleaning



Loose food residue, grease and meat juices may ignite during self-cleaning. Risk of fire. Before every self-cleaning operation, remove any coarse dirt from the oven.

Never hang flammable items, such as tea towels, on the door handle. Risk of fire.

The oven exterior will be very hot to the touch during the self-cleaning operation. Keep children at a safe distance.

Never clean metal sheets and dishes which have been coated with a non-stick coating using the oven's automatic self-cleaning function (pyrolysis operation). High temperatures can cause poisonous gases to be formed from the non-stick coating - risk of serious damage to health.

Reasons for damage

Baking tray, aluminium foil or dishes on the oven floor

Do not place the baking tray on the oven floor. Do not cover it with aluminium foil.

Do not place dishes on the oven floor.

This will cause heat accumulation. The baking and roasting times will no longer be correct and the enamel will be damaged.

Water in the oven

Never pour water directly into a hot oven. This could damage the enamel.

Fruit juice

When baking very moist fruit cakes, do not put too much on the baking sheet. Fruit juice dripping from the baking sheet leaves stains that cannot be removed.

It is recommended that you use the deeper universal pan.

Cooling with the oven door open

Only leave the oven to cool with the door closed. Do not allow anything to become trapped in the oven door. Even if you only leave the oven door open slightly, the fronts of adjacent units may become damaged over time.

Very dirty oven seal

If the oven seal is very dirty, the oven door will no longer close properly when the oven is in use. The fronts of adjacent units could be damaged. Keep the oven seal clean.

Using the oven door as a seat

Do not stand or sit on the oven door.

Your new cooker

Here you will learn more about your new oven. The control panel and its switches and indicators are explained here. The heating modes and the accessories included with your oven will be explained here.

The control panel

Details vary according to the appliance model.

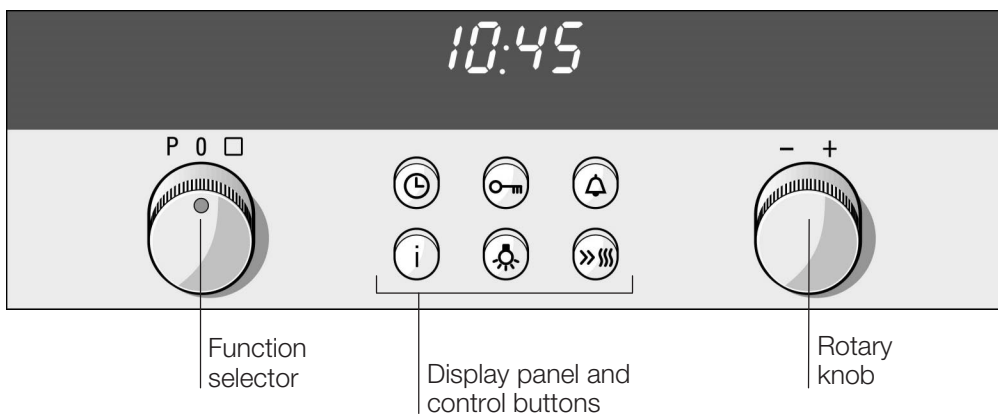

Function selector

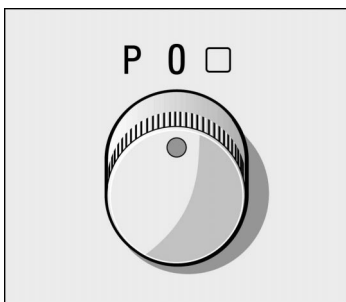

Use the function selector to select the type of heating for the oven. A default value appears in the display for each type of heating.

Settings

	Conventional heat
	Conventional baking*
	3D hot air
	Intensive fan-assisted cooking / pizza setting
	Bottom heating
	Hot air grilling
	Radiant grill - large area
	Automatic self-cleaning
P	Easy roasting

*Type of heating with energy efficiency class determined in accordance with EN50304.

The oven light switches on when you select a function.

Rotary knob

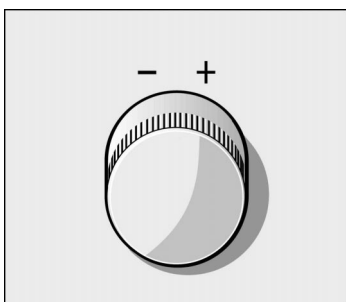







The default values and set values can be altered using the rotary knob.

Ranges

20 - 300	Temperature in °C The maximum temperature for the 3D hot air and intensive hot air / pizza setting setting = 275 °C
1 - 3	for grill settings, large areas Turn back to
1 - 3	for grill settings, small areas
1 - 3	Cleaning levels
1 min - 23.59 h	Duration
5 sec - 12.00 h	Timer period
P 01 - P 24	Programs
P 25	Sabbath program

Control buttons and display panel



Clock button 	Use this button to set the time of day, the cooking time  and the completion time  .
Key button 	Use this button to switch the childproof lock on and off.
Timer button 	Use this button to set the timer.
Info button i	Use this button to call up information.
Oven light button 	Use this button to switch the oven light on and off.
Rapid heating button 	Use this button to heat up the oven quickly.

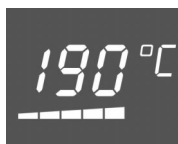

The values set can be seen in the display panel. The rise in temperature or the residual heat in the oven is shown in the preheating indicator below the temperature display.

Push-in control knobs

The control knobs can be pushed in. Simply press the control knob to release or lock it.

You can turn the control knobs to the left or to the right.

Types of heating

Different types of oven heating are available. You can therefore select the best method for cooking any dish.

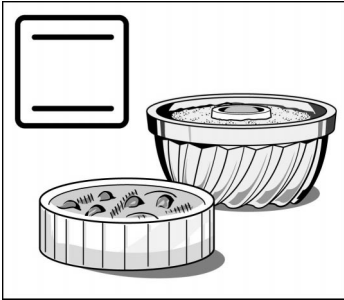

Top and bottom heating

This ensures the even distribution of heat onto the cake or roast from the top and bottom of the oven. This type of heating is best for cake mixtures in tins or for bakes. Top and bottom heating is also suitable for cooking lean roasts of beef, veal and game.

To keep food warm : You can keep food warm in the 65-100 °C temperature range. Do not keep food warm for longer than two hours.

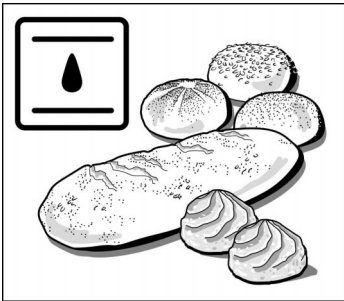

Conventional Baking

is the most energy-efficient type of heating. This type of heating also ensures even heat distribution to the food from the top and bottom of the oven. The moisture which is extracted during the baking is retained as steam in the oven. The food does not dry out.

Yeast-risen food such as bread, bread rolls or plaited buns turn out especially well when cooked using this type of heating. This type of heating is also best for cooking choux pastry goods such as cream puffs.

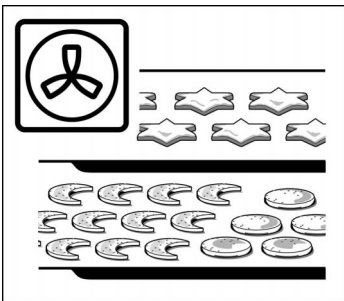

3D hot air

A fan in the rear panel distributes the heat from the ring heating element evenly inside the oven. Using 3D hot air, it is possible to bake cakes and pizza on two shelves. You can cook biscuits and puff pastry on three levels at the same time. The required oven temperatures are lower than those for top and bottom heating. Additional baking trays may be obtained from specialist shops.

3D hot air is ideal for drying food.

Defrosting : You can defrost food in the 20-60 °C temperature range.



Intensive hot air / pizza setting

This type of heating uses bottom heating and the ring heating element.

This type of heating is particularly suitable for deep-frozen foods. It is ideal for cooking pizzas, chips or strudels, without requiring preheating.

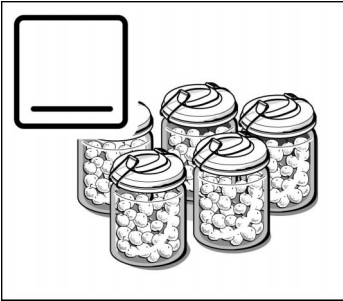

Bottom heat

You can reheat or brown meals using bottom heating. It is also the most suitable type of heating for preserving food.

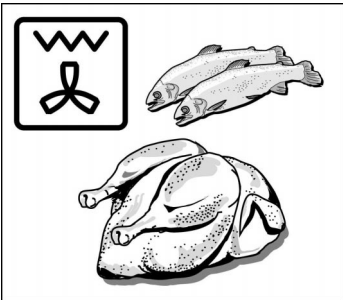

Hot air grilling

This type of heating involves the grill element and the fan switching on and off alternately. During the pause in heating, the fan circulates the heat generated by the grill around the food. This ensures that pieces of meat are crisped and brown on all sides.

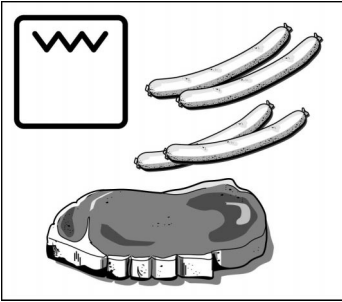

Radiant grill - large area

The entire area under the grill element becomes hot. This is ideal if you wish to cook several steaks, sausages, fish or slices of toast.

For radiant grilling, small areas ☐: Only the centre of the grill element becomes hot. This type of heating is ideal for cooking small quantities. This saves energy. Place the pieces to be grilled in the centre of the wire grill. Turn the rotary knob until the ☐ symbol changes to the ☐ symbol, and set the grill setting.

Notes

Heating is interrupted if you open the oven door while the oven is in operation.

To ensure that the heat is well distributed, the fan switches on for a short time during preheating for types of heating with top and bottom heating.

Oven and shelving accessories

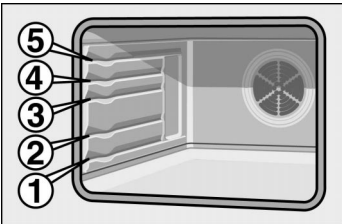

The shelf can be inserted at 5 different heights in the oven.

You can remove the shelf two thirds of the way without it tipping. This makes it easier to take food out of the oven.

Accessories

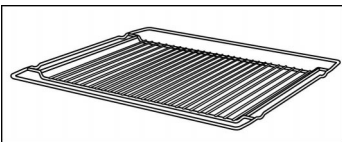

Accessories may be purchased at a later date from the after-sales service or from specialist shops. Please specify the HZ number.

HZ 334001 wire racks

For ovenware, cake tins, roasts, grilling and frozen meals.

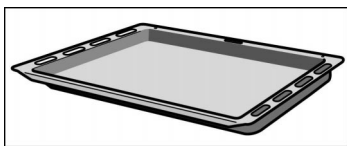

Universal pan HZ 332070

for moist cakes, pastries, frozen food and large roasts. It can also be used to catch dripping fat when you are grilling directly on the wire grill.

Push the universal pan with the sloping edge facing towards the oven door.

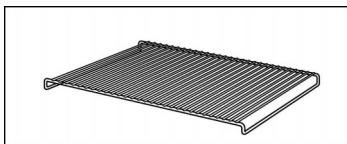

HZ 324000 wire rack

for grilling. Always place the wire grill in the universal pan. Fat and meat juices are collected.

Optional accessory

Optional accessories may be purchased from the after-sales service or from specialist shops.

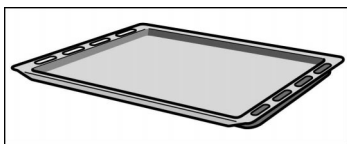

Enamel baking tray HZ 331070

for cakes and biscuits.

Push the baking tray with the sloping edge facing towards the oven door.

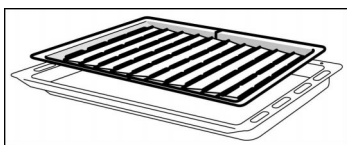

Grill pan HZ 325070

Can be used for grilling instead of the wire grill or as a spray guard to protect the oven against dirt. Only use the grill pan in the universal pan.

To grill using the grill pan: use the same shelf height as for the wire grill.

Using the grill pan as a spray guard: insert the universal pan with the grill pan under the wire grill.

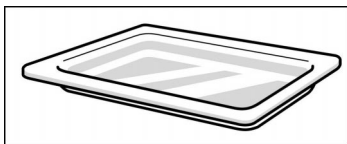

Glass pan HZ 336000

A deep baking tray made from glass. Can also be used as a serving dish.

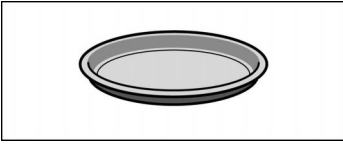

Pizza tray HZ 317000

Ideal for pizza, frozen foods and large round cakes, for example. You can use the pizza tray instead of the universal pan. Place the tray on the wire grill. Observe the information provided in the tables.

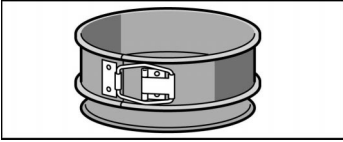

Baking tin HZ 26001

You can bake especially moist cakes using the leak-proof baking tin. The extra wide rim prevents leakage and your cooker stays clean. The baking tin has a non-stick coating on the inside.

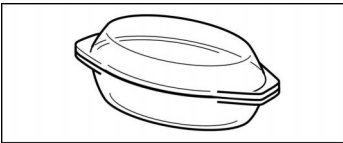

Glass roasting dish HZ 915000

for braised dishes and bakes that are cooked in the oven. It is especially suitable for the automatic roasting function.

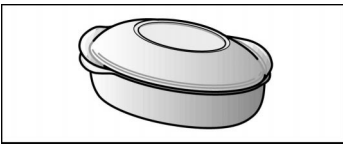

Metal roasting dish HZ26000

It is intended for use in the extended cooking zone of the glass ceramic hob. The dish is suitable for the sensor cooking system as well as for the automatic roasting function.

The roasting dish is enamel on the outside and has a non-stick coating on the inside.

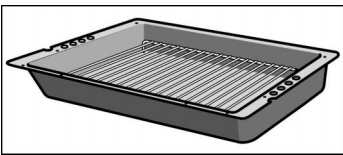

Profi extra-deep pan HZ 333070

for cooking large quantities of food.

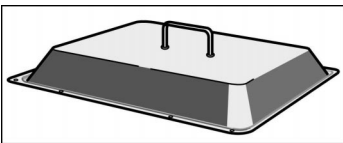

Lid for the Profi extra-deep pan HZ 333001

Converts the Profi extra-deep pan into the Profi roasting dish.

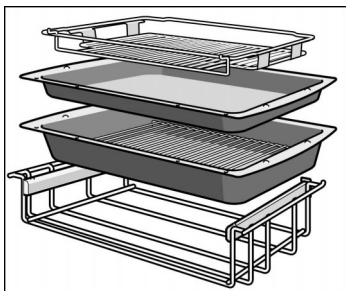

Profi oven drawer Plus HZ 333102

To be used for preparing large quantities of food. A deep pan, a shallow pan, a wire rack, a wire rack for placing on top and a telescopic shelf come as accessories.

You can grill foods very well using the wire rack placed on top of the drawer.

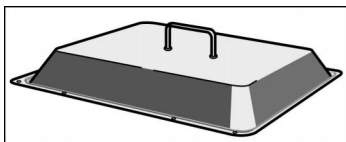

Lid for the Profi extension HZ 333101

Converts the Profi extra-deep pan into the Profi roasting dish.

Cooling fan

The oven is fitted with a cooling fan. It switches itself on and off as necessary. The warm air escapes above the door.

Before using for the first time



This section will tell you everything you need to do before using the cooker for the first time.

Heat the oven and clean the accessories. Read the safety instructions in the “Important information” section.

Firstly, check to see if the  symbol and three zeros are flashing in the display.

If the symbol and three zeros are flashing

Set the time.

1. Press the  clock button.
12:00 appears and the  clock symbol flashes.
2. Set the time using the rotary knob.

The time selected is adopted after a few seconds. The cooker is now ready for use.

Heating up the oven

Heat the empty oven with the door closed to remove the new oven smell.

Method

1. Set the function selector to top/bottom heating .
A suggested temperature appears in the display.
2. Use the rotary knob to set the temperature to 240 °C.

Switch off the function selector after 60 minutes.

Pre-cleaning the accessories

Please wash the accessories thoroughly with soapy water and a cleaning cloth before using them.

Setting the oven

You have various options for setting the oven.

Switching off the oven manually

When your meal is ready, switch off the oven yourself.

The oven switches off automatically

You can leave the kitchen for a long period.

The oven switches on and off automatically

You can put your meal in the oven in the morning, for example, and set the oven so that your meal is ready at midday.

Tables and tips

The correct settings for many dishes can be found in the Tables and tips section.

Setting procedure

1. Select the desired type of heating using the function selector.

The default value for this type of heating appears in the temperature display.

Example: Top/bottom heating, 190 °C

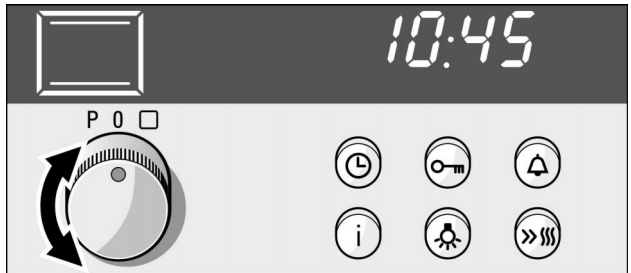

2. Use the rotary knob to set the temperature or grill setting.



Switching off

Switch off the function selector when the meal is ready.

Changing the setting

You may change the temperature or grill setting at any time.

Preheating indicator

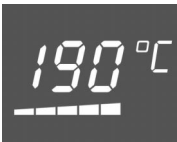



The preheating indicator provides a visual display of the oven temperature increase. It is best to insert the dish in the oven when all segments are lit. The preheating indicator does not appear if you are grilling.

You can call up the approximate preheating temperature with the Info i button.

The thermal inertia of the oven means that a temperature may be displayed during the heating up phase which differs from the actual oven temperature.

If the oven is to switch off automatically

3. Press the  clock button. The cooking time symbol  will flash.

Make settings as described in steps 1 and 2. Set the cooking time (duration) for your meal.

Example: Cooking time of 45 minutes

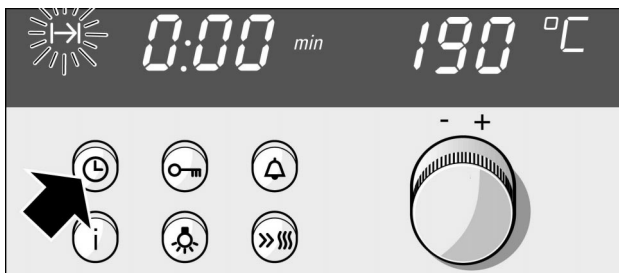

4. Set the cooking time using the rotary knob.

The oven switches on after a few seconds. The  symbol lights up in the display.



The cooking time has elapsed

A signal sounds. The oven switches off. Switch off the function selector.



Changing the setting

Press the  clock button. Use the rotary knob to change the cooking time.

Cancelling the setting



Switch off the function selector.

Calling up the settings

To call up the end time  or time : Press the  clock button until the relevant symbol flashes. The value called up will then appear for a few seconds.

If the oven is to switch on and off automatically

Perform the settings as described in steps 1 to 4.

5. Press the  clock button until the  end symbol flashes.

In the display you will see the time when the meal will be ready.

Please remember that easily spoiled foods must not be allowed to remain in the oven for too long.

Example: Imagine - it's 10:45 a.m. The meal will take 45 minutes to cook and must be ready at 12:45 pm.



6. Use the rotary knob to set a later end time.

The setting is adopted after a few seconds. The display will show the end time until the oven switches on.



The cooking time has elapsed

A signal sounds. The oven switches off. Switch off the function selector.

Note

You can change the setting while the symbol is flashing. The setting has been adopted if the symbol lights up permanently. You may change the waiting time that elapses before the setting is adopted. See the Basic settings section for more details.

Residual heat indicator

When you switch off the oven, the residual heat in the oven is indicated in the preheating indicator. When all segments are lit, the temperature in the oven is approximately 300 °C.

The preheating indicator goes out when the temperature has fallen to approximately 60 °C.

Using the residual heat





You can keep food warm in the oven using the residual heat.

For meals with long cooking times, you may switch off the oven 5 to 10 minutes earlier. The residual heat will finish cooking the meal, thereby saving energy.

Rapid heating

This allows you to heat up the oven particularly quickly.

Suitable types of heating

-  = Top/bottom heating
-  = Conventional Baking
-  = 3D hot air
-  = Intensive hot air
-  = Hot air grilling

Setting procedure

First set the oven.

Then press the rapid heating button .

The  symbol lights up in the display.

The oven will heat up. The segments of the preheating indicator will light up.

The rapid heating process is complete

You will hear a short signal. The  symbol will go out. Put your dish in the oven.

Cancelling the rapid heating function

Press the rapid heating button. The symbol will go out. The rapid heating process is cancelled.

Notes

The rapid heating function is interrupted if you change the type of heating.

The rapid heating function will not work if the temperature set is below 100 °C.

If the temperature in the oven is only slightly below the temperature set, the rapid heating function is not necessary. It will not switch on.

During the rapid heating phase, you can call up the current preheating temperature with the "Info i" button.

Automatic roasting

Using automatic roasting, you will be able to produce delicious braised meals, juicy roasts and tasty stews without the need for turning or basting the meat which, in turn, keeps your oven clean.

Ovenware

The automatic roasting function is only suitable for roasting in a covered dish. Only use a roasting dish with a suitable lid.

Suitable dishes

Suitable dishes are heat-resistant (up to 300 °C), glass or glass ceramic dishes.

Add more fluid when roasting in enamelled steel, cast-iron or pressed aluminium dishes. The food will brown more.

Please observe the instructions of the dish manufacturers.

High-grade steel dishes are only suitable in some cases. The food will not brown as much and the meat will not cook as well.

Unsuitable dishes

Dishes made of shiny aluminium, unglazed clay or dishes with plastic handles are not suitable.

Dish size

The meat should cover around two thirds of the base of the dish. This ensures that the meat juices turn out well.

There should be at least 3 cm between the meat and the lid. The meat may expand while roasting.

Preparing food

Select a suitable dish.

Weigh the fresh or deep-frozen meat, the fish or the vegetables if it is a vegetarian dish. You need this weight to adjust cooking times etc.

Close the dish with the lid. Place it on the wire grill at shelf position 2.

Meat

Add fluid to the empty dish if indicated in the roasting table. The base of the dish must be covered.

Season meat, place it in the dish and close with the lid.

Fish

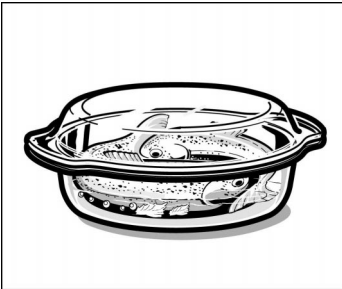

Clean the fish and add lemon juice and salt to taste.

Steamed fish: Add the fluid, e.g. wine or lemon juice, to a depth of $\frac{1}{2}$ cm.

Baked fish: Toss the fish in flour and coat with melted butter.

Note: Fish cooks best when placed in the “swimming position” in the dish.

Stew

You can combine different kinds of meat and fresh vegetables.

Cut the fish into bite-size pieces. Chicken pieces can be used without cutting them up.

Add double the amount of vegetables to meat.
Example: Use between 0.5 kg and 1 kg fresh vegetables for 0.5kg meat.

Always put the meal into the cold oven.

Programs

Fresh meals	Use for	Program number	Weight range	Add liquid
Roast beef joint	Spare ribs, shoulder, sides, braised marinated beef	01	0.5-3.0 kg	Yes
Roast beef	Roast beef, spare rib	02	0.5-2.5 kg	No
Roast beef, rare	Roast beef, spare rib	03	0.5-2.5 kg	No
Roast pork	Neck, collar, sides, thick flank, fillet	04	0.5-3.0 kg	Yes
Roast pork with crackling	Shoulder with rind, belly	05	0.5-2.0 kg	No
Roast veal	Shoulder, shank, thick flank, topside, stuffed breast of veal	06	0.5-2.5 kg	Yes
Leg of lamb	Boned	07	0.5-2.5 kg	Yes
Poultry	Chicken, duck, goose, baby turkey	08	0.5-2.5 kg	No
Drumsticks	Chicken, turkey, duck, goose drumsticks	09	0.3-1.5 kg	No
Turkey breast	Turkey breast, fillet	10	0.5-2.5 kg	Yes
Mutton, venison	Shoulder, neck, breast	11	0.5-2.5 kg	Yes
Pork loin, venison, small game	Leg of venison, leg of hare	12	0.5-3.0 kg	Yes
Meat loaf	Beef/pork meatloaf	13	0.3-3.0 kg	No
Stews	Roulade, meat and vegetable stew, Szegedin goulash	14	0.3-3.0 kg	Yes
Fish, steamed	Trout, pike-perch, carp, whole cod	15	0.3-1.5 kg	Yes
Fish, roasted	Trout, pike-perch, carp, whole cod	16	0.5-1.5 kg	No

Frozen meals*	Use for	Program number	Weight range	Add liquid
Roast beef joint	Spare ribs, shoulder, sides	17	0.5-2.0 kg	Yes
Roast beef	Roast beef, spare rib	18	0.5-2.0 kg	No
Roast pork	Neck, collar, sides, thick flank, fillet	19	0.5-2.0 kg	Yes
Roast veal	Shoulder, shank, thick flank, topside, stuffed breast of veal	20	0.5-2.0 kg	Yes
Leg of lamb	Boned	21	0.5-2.0 kg	Yes
Drumsticks	Chicken, turkey, duck, goose drumsticks	22	0.3-1.5 kg	No
Mutton, venison	Shoulder, neck, breast	23	0.5-2.0 kg	Yes
Venison, small game	Leg of venison, leg of hare	24	0.5-2.0 kg	Yes

* N.B. If preparing frozen meat, the end time cannot be set to a later time. The meat would thaw out before the program starts.

How long will the meal take to cook?

So that you know how long the meal will take to cook, make the settings as described in steps 1 to 4. The cooking time will appear in the display.

To interrupt the program: Switch off the function selector.

Setting procedure

1. Select the appropriate program from the roasting table.
2. Turn the function selector until P appears in the temperature display.

Example: Well-cooked roast beef, 1.2 kg



3. Use the rotary knob to set the program number you require.

When the program has been adopted, the default value for the particular weight appears.



4. Turn the rotary knob to enter the weight.

The oven switches on after a few seconds. The time counts down in the display.



The cooking time has elapsed

A signal sounds. The oven switches off. Switch off the function selector.

Cancelling the program

Switch off the function selector.



The oven will switch on and off automatically

Only use fresh meat or fresh fish.

Do not leave the food to stand in the oven for too long. Meat and fish will spoil easily when not in the refrigerator.

Example: Program 02, the meal will be ready at 12:15 pm.

Perform the settings as described in steps 1 to 4

5. Press the  clock button repeatedly until the  end symbol flashes. In the display you will see the time when the meal will be ready.



6. Use the rotary knob to set a later end time.

The setting is adopted after a few seconds. The end time is shown in the display. The  end symbol lights up. The oven switches on at the appropriate time.







The cooking time has elapsed

A signal sounds. The oven switches off. Switch off the function selector.

Note



The set time counts down in the display.

To call up the remaining cooking time , end time  or time : Press the  clock button repeatedly until the relevant symbol appears.

To call up the weight: Press the  info button.

Tips for automatic roasting

The weight of meat or poultry is over the specified weight range

The weight range is deliberately limited. It is rare to find casserole dishes of sufficient size for cooking large pieces of meat. Cook large pieces of meat using top/bottom heating  or hot air grilling .

The meat is good, but the juices are too dark

Use a smaller dish and more liquid.

The meat is good, but the juices are too clear and watery

Use a larger dish and less liquid.

The top of the roast is too dry

Use a casserole dish with a firmly fitting lid. Very lean meat stays more juicy if it is covered with bacon rashers.

While the meat is roasting, it smells as though it is burning even though the meat looks good

The roasting dish lid is not closed properly. Or the meat has risen and raised the lid. Always use a suitable lid. Ensure that there is a minimum distance of 3 cm between the meat and the lid.

You want to cook frozen meat

Season the frozen meat in exactly the same way as fresh meat. N.B. The end time cannot be set to a later time if cooking meat from frozen. The meat would defrost before the program starts.

You want to roast several chicken drumsticks or other poultry drumsticks at the same time

The drumsticks must be of approximately the same size. Enter the weight of the heaviest drumstick. Example: Two turkey drumsticks weighing 1.4 and 1.5 kg. Enter 1.5 kg.

You want to poach or bake several fish at the same time

The fish must be approximately the same size. Enter the total weight. Example: Two trout weighing 0.6 and 0.5 kg. Enter 1.1 kg.

You want to cook stuffed poultry

This method of cooking is not suitable for stuffed poultry. This is best cooked uncovered on the wire grill. Look up poultry in the table.

The meat in the stew is not sufficiently browned

Next time place the pieces of meat at the edge of the dish. Place the vegetables in the middle.

The vegetables in the stew are too hard

When cooking a stew, enter the weight of the meat. This ensures that the vegetables are crunchy. If you want the vegetables to be softer, enter the combined weight of the vegetables and meat.

You want to cook vegetarian stew

Only use firm vegetables, such as carrots, green beans, white cabbage, celery and potatoes. The smaller you cut the vegetables, the softer they will be. Cover the vegetables with liquid to prevent them from browning excessively.

You wish to use your stainless steel roasting dish

The stainless steel dish is only suitable to a certain degree. The shiny surface reflects much of the heat radiation. The meal will not brown as much and the meat will be less well done. If you use the stainless steel roasting dish: Remove the lid once the program has ended. Grill the meat at grill setting 3  for a further 8 to 10 minutes.

Sabbath setting

With the Sabbath setting, you can use top/bottom heating  to keep the oven at a temperature of 85 °C for 73 hours.

During this time, you can keep meals warm without needing to switch the oven on or off.

Setting procedure

- 1.** Set the function selector to P.
P flashes in the display.
- 2.** Use the rotary knob to select the P25 program.
If P lights up, the setting has been adopted. The duration counts down in the display. The oven switches off automatically after 73 hours.

The program has ended

A signal sounds. The  duration symbol flashes. Switch off the function selector to display the time again.

Cancelling the program

Switch off the function selector.

Notes

The buttons are locked once the program has started. It is not possible to call up or modify settings.

The oven light is lit during the entire program.

Time

When the oven is first connected, or following a power cut, the ⌚ symbol and three zeros flash in the display. Set the time.

The function selector must be switched off.

Setting procedure

Example: 13:00

1. Press the ⌚ clock button. 12.00 appears in the display and the ⌚ symbol flashes.



2. Set the time using the rotary knob.

The time selected is adopted after a few seconds. The ⌚ symbol will go out.



Changing the time e.g. from summer to winter time

Press the ⌚ clock button and use the rotary knob to change the time.

Hiding the time

You can hide the time. To do this, you must change the basic setting. See the Basic settings section.

Timer

You can use the timer as a kitchen timer. It operates independently of the oven.

The timer has a special signal.

You can also set the timer if the childproof lock is active.

Setting procedure

Example: 20 minutes

1. Press the  timer button. The  symbol will flash.



2. Set the alarm time using the rotary knob.

The timer starts after a few seconds. The  symbol lights up in the display. The time counts down visibly.



The time has elapsed

A signal sounds. Press the  timer button. The timer display will go out.

Changing the timer period

Press the  timer button. Change the time using the rotary knob.

Cancelling the setting

Press the  timer button 3x.

The timer and cooking time count down simultaneously

The symbols light up. The timer period counts down visibly in the display.

To call up remaining cooking time **I→I**, end time **→I** or time **⌚**: Press the **⌚** clock button until the appropriate symbol flashes.

The value called up will then appear in the display for a few seconds.

Basic settings

Your oven has several basic settings. You may change the basic settings for the time, the signal duration and the reset time for a setting.



Basic setting	Function	Change to
Time ⌚ <i>i</i> = Time in the foreground	Time display	Time ⌚ = Time hidden*
Signal duration ⏰ <i>i</i> = approx. 10 seconds	Signal after cooking time or timer period has elapsed.	Signal duration ⌚ = approx. 1 min. ⏰ = approx. 4 mins.
Reset time I→I ⌚ = medium	Waiting time between the adjustment increments before the setting is adopted.	Reset time <i>i</i> = short ⏰ = long

* Exception: The time is shown when the residual heat is displayed.

Changing the basic settings

There must be no program set.

Example: Hiding the time

1. Press the  clock button and the  button simultaneously until a *!* appears in the display. This is the basic setting for the time in the foreground.

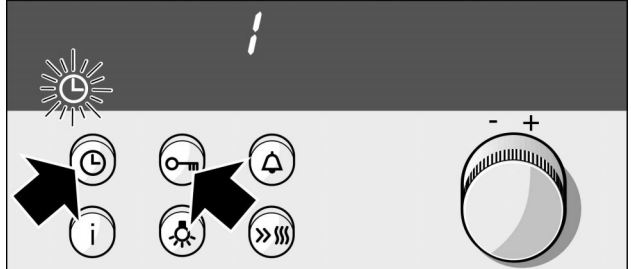



2. Use the rotary knob to change the basic setting.

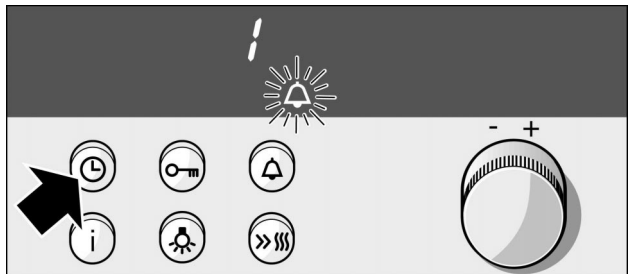

3. Confirm with the  clock button.

A *!* will appear in the display for the basic setting for the signal duration.



Change the basic setting as described in step 2 and confirm with the  clock button. You can now change the reset time. To finish press the  clock button.

You do not wish to change all the basic settings

If you do not wish to change a basic setting, press the  clock button. The next basic setting will appear.

Correcting settings



You may change your settings again at any time.

Childproof lock

The oven has a childproof lock to prevent children switching it on accidentally.

Locking the oven

The function selector must be switched off.

Press the  key button until the  symbol appears in the display. This will take approximately 4 seconds.

Unlocking

Press the  key button until the  symbol goes out.

Notes

You can set the timer and the clock even when the oven is locked.

Automatic time limiter

If you have forgotten to switch off the oven, the automatic time limiter will be activated. Oven operation will be interrupted. The time when this happens depends on the selected temperature or grill setting.

A **5** appears in the clock display when the oven is no longer heating up.

The heating function is interrupted until you switch off the function selector. The **5** will go out.

You can now reset the oven.

Cancelling the automatic time limiter

If you enter a cooking time, the oven will then switch off automatically.

The time limiter is cancelled.

Automatic self-cleaning

The oven is heated to approximately 500 °C. Any food residues from roasting, grilling and baking are burnt to ash.

You may choose from three cleaning levels.

Level	Degree of cleaning	Duration
1	Low	approx. 1¼ hours
2	Medium	approx. 1½ hours
3	Intensive	approximately 2 hours

What you should know

For safety reasons, the oven locks automatically. You can only open the oven door again when the  locking symbol in the display goes out.



The exterior of the oven will become very hot. Make sure that nothing is placed against the front panel. Keep children at a safe distance.

If you open the oven again after automatic self-cleaning begins, the locking latch may be visible at the top of the oven. This is normal. The latch disappears automatically when you close the door again. Please do not attempt to push in the latch by hand.

You cannot switch the oven light on during automatic self-cleaning. The preheating indicator does not appear.

Before automatic self-cleaning

Remove unsuitable accessories and all ovenware from the oven.



Risk of fire. Loose food residue, grease and meat juices are flammable.

Wipe the oven and the accessories that are to be cleaned at the same time with a damp cloth.

Clean the oven door and along the edges of the oven around the seal. Do not scour the seal.

Cleaning accessories at the same time



Insert the universal pan at shelf position 2 for self-cleaning.

The wire grill is not suitable for self-cleaning.

Never clean metal sheets and dishes which have been coated with a non-stick coating using the oven's automatic self-cleaning function (pyrolysis operation). High temperatures can cause poisonous gases to be formed from the non-stick coating - risk of serious damage to health.

Setting procedure

Example: Cleaning level 3

1. Set the function selector to

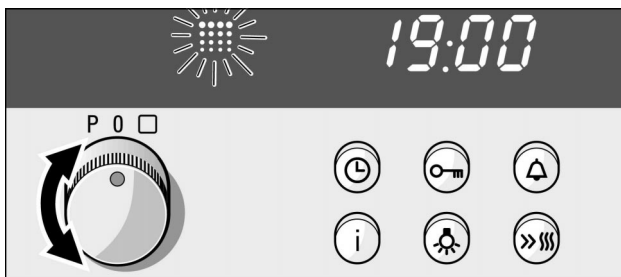

2. Use the rotary knob to set the desired cleaning level.

Self-cleaning starts after a few seconds.



The cleaning time has elapsed

A signal sounds. The symbol flashes.

The symbol lights up

The oven is hot and locked for safety reasons. The oven door will only open when the symbol goes out. Only then should you switch off the function selector.

Calling up the cooking time and end time

To call up the remaining cooking time **I→I** or end time **→I**:

Press the  clock button until the relevant symbol flashes.

Self-cleaning should switch on and off automatically

This enables you to make use of the cheaper off-peak electricity rates, for example.

Make settings as described in steps 1 and 2

Example: You want automatic self-cleaning to finish at 23:00.

3. Press the  clock button repeatedly until the **→I** end symbol flashes.

The display shows when automatic self-cleaning will be finished.



4. Use the rotary knob to set a later end time.

The self-cleaning function switches on and off at the appropriate times. The clock reappears once self-cleaning has started.



The cleaning time has elapsed

A signal sounds. The **→I** symbol flashes. Switch off the function selector.

Cancelling the setting

Switch off the function selector.

Notes

The cleaning level can no longer be changed once the cleaning operation has been started.

When the oven has cooled

Wipe away any remaining ash from inside the oven using a moist cloth.

Note

Under normal use, it is usually sufficient to clean the oven every two to three months. You only require about 2.5 - 4.7 kilowatt hours for each self-cleaning process.

The special heat-resistant enamel and the shiny parts in the oven may become dull or discoloured over time. This is normal and does not affect the function. Do not use coarse scouring pads or strong cleaning agents to remove such discolorations.

Care and cleaning

Do not use high-pressure cleaners or steam jets.

Oven exterior

Wipe the oven with water and a little washing-up liquid. Dry it with a soft cloth.

Caustic or abrasive substances are not suitable. If any such substances come into contact with the frontage, wipe it off immediately with water.

Note

Slight differences in the colours on the appliance front are caused by the use of different materials, such as glass, plastic and metal.

Shadows on the door panel which resemble smears are reflections from the oven light.

Appliances with stainless steel fronts

Always remove any flecks of limescale, grease, cornflour and egg white immediately. Corrosion can form under such flecks.

Use stainless steel care products. Follow the manufacturer's instructions. Try out the product on a small area first, before using on the whole surface.

Appliances with aluminium fronts

Use a mild window-cleaning detergent. Wipe the area with a soft window cloth or a fluff-free micro-fibre cloth, using a horizontal action without applying pressure.

Aggressive cleaning products, scratchy sponges and rough cleaning cloths are not suitable.

Oven

Cleaning the enamelled surfaces of the oven

Never use coarse scouring pads or cleaning sponges. Oven cleaner may only be used on enamelled oven surfaces.

Use hot soapy water or a vinegar solution.

It is best to use oven cleaner if the oven is very dirty. Only use oven cleaner in a cold oven.

Note:

Enamel is baked on at very high temperatures. This can cause some slight colour variation. This is normal and does not affect the function. Do not use coarse scouring pads or strong cleaning agents to remove such discolorations.

The edges of thin trays cannot be completely enamelled. As a result, these edges can be rough. Anti-corrosion protection is guaranteed.

Cleaning the glass cover for the oven light

It is best to clean the glass cover with washing-up liquid.

Cleaning the glass panels

The glass panels on the oven door can be removed to assist in cleaning.

Depending on the appliance model, the oven door can be opened from the right or the left.

The glass panel can be removed in this way for doors which open from the left and from the right.

Removal

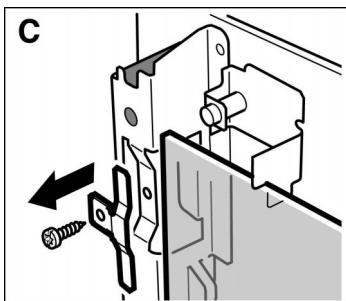
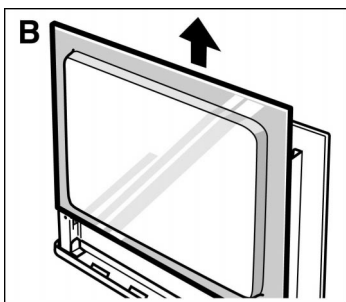
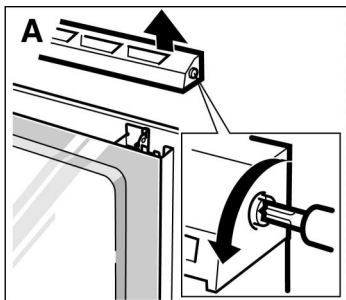

1. Open the oven door.
2. Remove the cover from the top of the oven door. To do this, undo the left-hand and right-hand screws (Fig. A). Use one hand to hold the panel firmly.
3. Slide the panel upwards (Fig. B).
4. Unscrew the clips on the left and right and remove them (Fig. C). Remove the panel.
5. The seal at the bottom of the panel can be removed for cleaning. To do this, unhook the seal on the left and right.

Clean the glass panels with glass cleaner and a soft cloth.

Installation

Before you insert the panel, replace the seal again at the bottom of the panel.

Please make sure when fitting the glass panel that “Right above” appears at the top right on the panel.

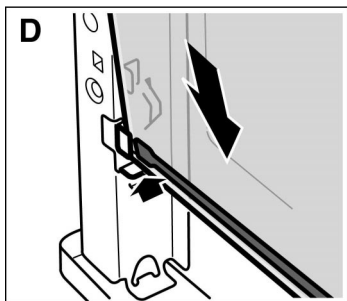

1. Insert the glass panel downwards at an angle. (Fig. D)

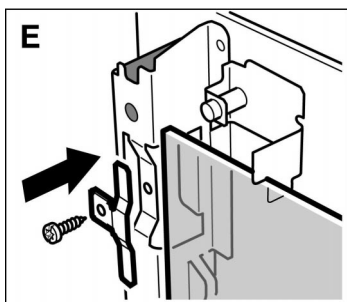

2. Fit the clips and screw them in again (Fig. E).
3. Insert the top panel and hold it in place.
4. Replace the cover and screw it back on.
5. Close the oven door again.

The oven must not be used again until the panels have been correctly installed.

Seal

Clean the seal on the oven with washing-up liquid. Never use caustic or abrasive detergents.

Steam filter

The oven cover features a steam filter. This filters out grease particles in the extracted air, thereby reducing odours.

The filter must be cleaned occasionally.

Method

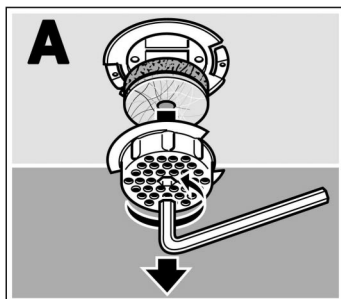

1. Using an Allen (6 mm), turn the filter head anticlockwise and remove. Figure A.

2. Remove both filter elements.

The filter head and the thin, single-layer filter element can be cleaned with washing-up liquid or washed in the cutlery basket of the dishwasher. You must not wash the thicker filter element. The coating could be damaged.

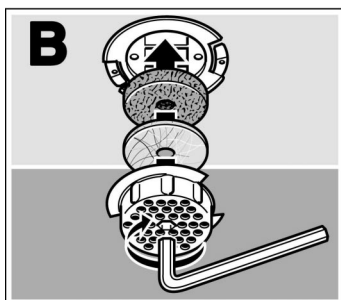

3. Place the single-layer filter element and then the double-layer filter element back in the filter head.

4. Insert the filter head and, using the Allen key, tighten it by turning it clockwise.

The filter head must be inserted as shown in Figure B. Only then can it be re-fitted securely.

Accessories

Immediately after use, soak the accessories in washing-up liquid. Food residues can then be easily removed with a brush or sponge.

The universal pan can be cleaned at the same time as the automatic self-cleaning.

Troubleshooting

Should a malfunction occur, it is often only due to a minor fault. Please read the following instructions before calling the after-sales service:

Problem	Possible cause	Comments/remedy
The oven does not work.	Blown fuse	Look in the fuse box and check that the fuse is in working order.
The clock display flashes.	Power cut	Reset the time.
The oven door cannot be opened. The function selector is in the  position and three zeros are flashing in the display.	Power cut	Switch off the function selector. Set the time of day and restart self-cleaning. If you no longer wish to repeat automatic self-cleaning, you must still wait for the oven temperature to fall below 300 °C.
The oven does not heat up.	The oven door is not properly closed.	Close the oven door fully.
The oven does not heat up or the type of heating selected cannot be set.	Dust on the contacts.	Turn the function selectors round completely several times.
The oven does not heat up. A square appears in the temperature display.	The appliance is currently in demo mode.	Switch off the fuse in the fuse box. Wait for approximately 20 seconds. Switch on the fuse again. Within the next 2 minutes, press the rapid heating up button for 6 seconds until the square in the display disappears.
A “5” appears in the clock display.	The automatic time limiter was activated.	Switch off the function selector.
The “Er 1” or “Er 4” error message appears in the clock display.	The temperature sensor has failed.	Contact the after-sales service.
The “Er 2” error message appears in the clock display.	Incorrect mains connection	Remove the fuses from the fuse box and connect the cooker properly.
The “Er 6” error message appears in the clock display. You have set self-cleaning.	The lock on the oven door is defective.	Remove the fuse from the function selector and call the after-sales service. All other oven functions can be used.

Problem	Possible cause	Comments/remedy
The oven door cannot be opened. The “Er 7” error message appears in the clock display.	The oven door release mechanism is faulty.	Contact the after-sales service.
The “Er 11” error message appears in the clock display.	A button has been pressed for too long or a button has jammed.	Press all buttons separately. If the error message remains, please contact the after-sales service.

Repairs may only be carried out by fully trained after-sales service technicians.

Improper repairs may constitute serious hazards to the user.

Replacing the oven light

If the oven light fails, it must be replaced. 40 watt heat-resistant spare bulbs can be obtained from the after-sales service or specialist shops. Only use these bulbs.

Method

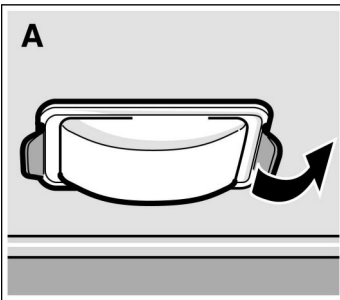

1. Switch off the oven fuse in the fuse box.
2. Place a tea towel in the cold oven to prevent damage.
3. Remove the glass cover. To do this, press back the metal tab with your thumb. Figure A.

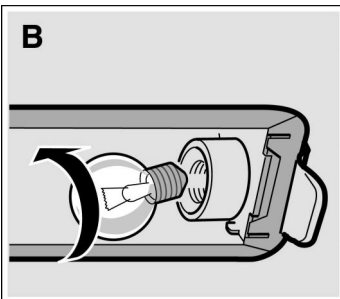

4. Unscrew the bulb and replace it with one of the same type. Figure B.
5. Fit the glass cover back on. To do this, insert it on one side and press firmly on the other side. The glass cover will now click into place.
6. Remove the tea towel and switch the fuse back on.

Replacing the glass cover

The glass cover on the oven light must be replaced if it is damaged. Replacement glass covers may be obtained from the after-sales service. To this end, please specify the E number and FD number of your appliance.

After-sales service

Our after-sales service is there for you if your oven needs repairing. You will find the address and telephone number of your nearest after-sales service centre in the phone book. The after-sales service centres listed will also be happy to advise you of a service point in your area.

E number and production number

Please quote the E number (product number) and the FD number (production number) of your appliance when contacting the after-sales service. The rating plate bearing these numbers is found on the side of the oven door. You can make a note of these numbers in the space below to save time in the event of your appliance malfunctioning.

E no.	FD no.
-------	--------

After-sales service ☎

Packaging and old appliances

Disposing in an environmentally-responsible manner

Unpack the appliance and dispose of the packaging in an environmentally-responsible manner.



This appliance is labelled in accordance with the European Directive 2002/96/EC concerning used electrical and electronic appliances (waste electrical and electronic equipment – WEEE).

The guideline determines the framework for the return and recycling of used appliances as applicable.

Tables and tips

This table contains a selection of dishes and the optimum settings at which to cook them. You can find out which type of heating and temperature is best for your dish, which accessories to use, and at which oven level the dish should be inserted. You will find a variety of tips about ovenware and preparation, and a small troubleshooting section in case anything should go wrong.

Cakes and pastries

Baking on one level

If you are baking cakes on one level, you should use top/bottom heating . This will give the best results for your cakes.

Baking tins

It is best to use dark-coloured baking tins made of metal. Baking times are increased when light-coloured baking tins made of thin metal or glass dishes are used, and cakes do not brown so evenly.

Always place the cake tin on the wire grill.

Tables

The values in the table apply to dishes placed in a cold oven. This saves energy. Shorten the baking times indicated by 5 to 10 minutes if you have preheated the oven.









The tables show which type of heating is best for different cakes and bakes.

The temperature and cooking time you select depends on the quantity and type of pastry. This is why “ranges” are given in the tables. You should try to use a lower temperature setting to start with, since this allows more even browning. If necessary, use a higher temperature setting the next time.

Note: Condensation may form on the inner pane in the oven door as a result of the high moisture content created when cooking using  conventional baking. Steam escapes when you open the oven door.

More information can be found in the “Baking tips” section which follows the tables.





Conventional heat

Food	Dish	Shelf position	Cooking method	Temp. °C	Time, minutes
Light fruit cake	20 cm tin	2		180	70-80
Fruit crumble	glass dish	3		180	35-45
Jam tarts*	12 hole bun tin	2		200	15-20
Yeast cookery* (f.ex.Pizza)	universal pan	2		230	20-30
Tarts**	20 cm plate or pie tin	1		210	40-50
Quiches**	glass dish	1		210	40-50
Rich Biscuits	baking tray	3		180	15-20
Soufflés*	1,2 l soufflé dish	2		180	40-50
Pies**	pie dish	2		200	45-55

* Preheat oven





** For a crispy bottom always place dish on the universal pan

3D-Hot air

Food	Dish	Shelf position	Cooking method	Temp. °C	Time, minutes
Rich fruit cake	Ø 23 cm round tin or 20 cm square cake tin	2		140	180-190
Meringues	universal pan	3		90	100-150
Pavlova	universal pan	3		150*+ 100	100-120
Jacket Potatoes	universal pan	2		170	60-70









* Preheat oven

Conventional baking

Food	Dish	Shelf position	Cooking method	Temp. °C	Cooking time, min
Bread	loaf tin (900 g or 2x 450 g)	1		240	25-35
Scones*	baking tray	1		210	15-20
Swiss Roll*	swiss roll tin	2		200	10-12
Victoria sandwich	20 cm tins	2		180	20-30
Yorkshire Pudding*	12 hole bun tin	1		200	25-35

* Preheat oven

3D-Hot air Baking on 2 or 3 levels

Food	Dish	Shelf position	Cooking method	Temp. °C	Cooking time, min
Victoria sandwich	20 cm tins	1+3		160	35-40
Scones*	baking trays	1+3		180	20-30
Jacket potatoes	wire racks	1+3		160	60-90
Biscuits	baking trays**	1+3		160	20-25
		2+3+5		150	25-30
Small Cakes*	baking trays**	1+3		150	25-35
Meringues	baking trays**	1+3		90	100-150
		2+3+5		90	100-150
Full meal	universalpan + wire rack	1+4		180	75-85

* Preheat oven

** When baking on two levels, use the universal pan provided, at shelf position three. When baking on three levels, use the universal pan at shelf position two. The universal pan can be removed earlier.

Baking tips

You wish to cook to your own recipe.

Refer to the instructions in the tables for similar types of food.

How to check that a sponge cake is cooked properly.

Approximately 10 minutes before the end of the baking time given in the recipe, pierce the tallest point of the cake with a cocktail stick. The cake is done if the cocktail stick comes out clean.

The cake collapses.

Next time, use less liquid or decrease the oven temperature by 10 degrees. Observe the cooking times in the recipe.

The cake has risen in the centre but is lower at the edges.

Do not grease the sides of the springform cake tin. As soon as the cake is done, carefully loosen the cake around the edges using a knife.

The cake is too dark at the top.

Insert it at a lower level in the oven, select a lower temperature and cook the cake a little while longer.

The cake is too dry.

Use a toothpick to make small holes in the finished cake. Then drizzle fruit juice or alcohol over the top. Next time you should decrease the temperature by around 10 degrees and reduce the baking times.

The bread or cake (e.g. cheesecake) looks fine, but is soggy on the inside (soft, with watery areas).

Next time you should add a little less liquid and cook for a little longer at a lower temperature. Cakes with fruit topping: Precook the base first of all. Sprinkle with almonds or breadcrumbs and then place the topping over this. Please observe the recipe and the baking times.

The pastry is unevenly browned.

Select a slightly lower temperature to ensure that the pastry is baked more evenly. Delicate pastry should be baked on one level using top/bottom heating . Baking paper that protrudes over the food can affect the air circulation. For this reason, always cut the baking paper to fit the baking tray.

The fruit cake is too light at the bottom. The fruit juice flows over.

Use the deeper universal pan next time.

You were baking on several levels. The food on the top baking tray is darker than that on the bottom baking tray.

Always use 3D hot air  when baking on several levels. Baking trays that are placed in the oven at the same time will not necessarily be ready at the same time.

Condensation is formed when baking cakes containing fresh fruit.

Baking may result in the formation of water vapour. It escapes above the door handle. The steam may settle and form water droplets on the control panel or on the fronts of adjacent units. This is a normal physical process.

Meat, poultry, fish

Ovenware

You may use any heat-resistant dishes. The universal pan is also suitable for larger roasts.

Always place the dishes in the centre of the wire grill.

Hot glass dishes should be placed on a dry kitchen towel after being removed from the oven. The glass could crack if placed on a cold or wet surface.

Advice on roasting

The roasting result depends on the type and quality of meat.

Add 2 to 3 soup spoons of liquid to lean meat, and 8 to 10 soup spoons of liquid to pot roasts, depending on the size.

Meat should be turned half way through the cooking time.

When the roast is ready, switch off the oven and leave the roast to stand for 10 minutes with the oven door closed. This allows the meat juices to distribute more favourably.

Advice on grilling

Always close the oven door when grilling.











If possible, use pieces of meat which are of the same thickness. They should be at least 2 to 3 cm thick. Such pieces will be browned evenly and stay juicy and soft in the middle. Only salt the steaks after they have been grilled.

Place the pieces of meat directly onto the wire grill. If you are grilling just one piece of meat, it will turn out best if you place it in the centre of the wire grill. You should also insert the universal pan at level 1. The meat juices are collected here and the oven is kept clean.





Turn the pieces of meat after two thirds of the cooking time indicated.

The grill element automatically switches itself off and back on again. This is normal. The number of times this happens depends on the grill setting you have selected.

Roasting

Food	Shelf position	Cooking method	Temp. °C	Cooking time min per 1 lb.
Beef rare	1		220-240	15+15
Beef medium	1		210-230	15+20
Beef well done	1		200-220	20+25
Beef fillet	1		210-230	15+20
Lamb medium	1		170-190	25+25
Lamb well done	1		150-170	30+30
Pork	1		180-200	30+30
Chicken, Duck, Goose and Turkey up to 5 kilo	1		170-210	20+20
Large Turkey	1		170-190	13+13
Chops and chicken joints	2		190-220	30

Grilling

Food	Shelf position	Cooking method	Grill	Cooking time min per 1 lb.
Meat steaks, bacon	5		2 or 3	12-22
Sausages and Fish fingers	4		3	15-20
Fish	4		2	10-20
Toast, 4 pieces	4		3	6-7
Toast, 9 pieces	4		3	4-5

Tips for roasting and grilling

The table does not contain information for the weight of the roast.

Select the next lowest weight from the instructions and extend the time.

How can you tell when the roast is ready?

Use a meat thermometer (available from specialist shops) or carry out a "spoon test". Press down on the roast with a spoon. If it feels firm, it is ready. If the spoon can be pressed in, it needs to be cooked for a little longer.

The roast is too dark and the crackling is partly burnt.

Check the shelf position and temperature.

The roast looks good, but the juices are burnt.

Next time, use a smaller roasting dish or add more liquid.

The roast looks good, but the juices are too clear and watery.

Next time, use a larger roasting dish or add less liquid.











Steam rises from the roast when the juice is basted.





Use hot air grilling instead of top/bottom heating. This prevents the bottom of the roast from becoming too hot, thereby producing less steam.

Frozen foods

Please observe the instructions on the packaging.

The values in the table apply to dishes placed in a cold oven.

Meal	Use for	Level	Type of heating	Temperature in °C	Cooking time in minutes
Pizza*	Pizza with a thin base	2		200-220	15-25
	Pizza with a thick base	2		180-200	20-30
	Pizza baguette	2		180-200	20-30
	Mini pizza	3		190-210	10-20
Potato products*	Chips	2		200-220	20-30
	Duchess potatoes	2		200-220	20-30
	Fried potatoes	2		200-220	20-30
	Filled potato skins	2		200-220	15-25
Baked goods*	Rolls	3		190-210	10-20
	Pretzels	3		200-220	10-20

Meal	Use for	Level	Type of heating	Temperature in °C	Cooking time in minutes
Fried foods*	Fish fingers	2		200-220	5-15
	Chicken nuggets	2		200-220	10-20
	Vegetable burgers	2		200-220	15-25
Strudel*	Apple strudel	3		190-210	30-40

* Line the universal pan with greaseproof paper. Please ensure that the greaseproof paper is suitable for use at these temperatures.



Defrosting



Remove the food from its packaging and place it in a suitable dish on the wire grill.

Please observe the instructions on the packaging.

The defrosting times depend on the type and amount of food.

Setting procedure

1. Set the function selector to  3D hot air.
2. Set the temperature using the rotary knob. The  3D hot air symbol is replaced by the  defrost symbol.

Meal	Accessories	Level	Type of heating	Temperature in °C
Delicate frozen foods e.g. cream gateaux, cream cakes, cakes with chocolate or icing, fruit etc.	Wire rack	2		20 °C
Other frozen foods* Chicken, sausage and meat, bread, bread rolls and other pastries	Wire rack	2		50 °C

* Cover frozen food with microwave foil. Place poultry onto the plate with the breast side down.





In the 30 to 60 °C range, the oven light remains switched off. This gives best control.

Drying

Only use perfectly fresh fruit and vegetables, and wash them thoroughly.

Allow the food to drain well and dry it yourself.

Line the universal pan and wire rack with baking paper or greaseproof paper.

Meal	Level	Type of heating	Temperature in °C	Cooking time in hours
600 g apple rings	2 + 4		80	Approx. 5
800 g sliced pears	2 + 4		80	Approx. 8
1.5 kg prunes or plums	2 + 4		80	Approx. 8 - 10
200 g fresh herbs, washed	2 + 4		80	Approx. 1½

Note

Very moist fruit or vegetables should be turned several times. Once dried, remove the food from the paper immediately.

Preserving

Preparation

The jars and rubber sealing rings must be clean and intact. Use jars of the same size if possible. The instructions in the table refer to round 1-litre jars. Caution Do not use larger or taller jars. The lid could crack.

Only use perfectly fresh fruit and vegetables. Wash them thoroughly.

Pour the fruit or vegetables into the jars. Wipe clean the tops of the jars again if necessary. They must be clean. Place a wet rubber sealing ring and lid on each jar and lock the jars using clamps.

Do not place more than six jars in the oven.

The times specified in the tables are guidelines only. They can be influenced by the room temperature, the number of jars and the amount and temperature of the jar contents. Before you change settings or switch off the appliance, make sure that the contents of the jars are actually bubbling.

Setting procedure

1. Place the universal pan on level 2. Place the jars inside the pan so that they do not come into contact with each other.
2. Pour ½ litre of hot water (approx. 80 °C) into the universal pan.
3. Close the oven door.
4. Switch the function selector to .
5. Set the rotary knob to 170 to 180 °C.

Preserving fruit

As soon as the contents of the jars begins to simmer, that is when small bubbles appear at short intervals - after about 40 to 50 minutes - turn off the function selector.

The jars should be removed from the oven after being reheated for 25 to 35 minutes. If the food is left to cool in the oven for longer, bacteria might form, causing the preserved fruit to spoil prematurely.

Fruit in 1-litre jars	After bubbling	Reheating
Apples, red/blackcurrants, strawberries	turn off	approx. 25 minutes
Cherries, apricots, peaches, gooseberries	turn off	approx. 30 minutes
Apple purée, pears, plums	turn off	approx. 35 minutes

Preserving vegetables

As soon as the contents of the jars begins to simmer, set the rotary knob back to approximately 120 to 140 °C. The table shows when you can switch off the oven. Allow the vegetables to stand in the oven for a further 30 to 35 minutes.

Vegetables with cold stock in 1-litre jars	After bubbling 120 - 140 °C	Reheating
Cucumbers	–	approx. 35 minutes

Vegetables with cold stock in 1-litre jars	After bubbling 120 - 140 °C	Reheating
Beetroot	approx. 35 minutes	approx. 30 minutes
Brussel sprouts	approx. 45 minutes	approx. 30 minutes
Beans, kohlrabi, red cabbage	approx. 60 minutes	approx. 30 minutes
Peas	approx. 70 minutes	approx. 30 minutes

Remove the jars

Never place the hot jars on a cold or wet surface as this could cause the glass to crack.

Energy saving tips

Only preheat the oven if it specifies in the recipe or in the table in the instruction manual that you should do so.

Use non-stick, black painted or enamelled tins. They absorb the heat especially well.

If you have several cakes to bake it is best to bake them one after the other. The oven is still warm. This shortens the baking time for the second cake. You can also put two baking tins in one after the other.

For long cooking times, the oven can be switched off 10 minutes before the end of the cooking time and the remaining heat can be used to finish the cooking.

Acrylamide in food

Experts are currently discussing how dangerous acrylamide in food can be. We have compiled this information sheet for you on the basis of current research.

Where does acrylamide come from?

Acrylamide in food does not come from external contamination. It is formed in the food itself during preparation - provided that the food contains carbohydrate and protein. Exactly how this happens has not yet been completely explained. However, it appears that the acrylamide content is strongly influenced by:

- high temperatures
- a low water content in food
- intensive browning of the food.

What sort of foods are affected?

Acrylamide forms mostly in grain and potato products that are prepared at high temperatures, e.g.:

- crisps, chips,
- toast, rolls, bread,
- baked goods made from shortcrust pastry (speciality biscuits and cakes).

What can you do?

You can avoid high levels of acrylamide when baking, frying and grilling.

The following recommendations were published by AID¹ and BMVEL² to help you minimise acrylamide levels:

In general

Keep cooking times as short as possible.

“Brown rather than burn” - cook food only until it is golden brown.

The larger and thicker the food is, the less acrylamide it contains.

Baking

Set the temperature to a maximum of 200 °C when using the top/bottom heating setting, and to a maximum of 180 °C for the 3D hot air setting.

Cookies: Set the temperature to a maximum of 190 °C when using the top/bottom heating setting, and to a maximum of 170 °C for the 3D hot air setting. The presence of egg or egg yolk in a recipe reduces the formation of acrylamide.

Spread oven chips evenly over the baking sheet in one layer where possible. To prevent the food from drying out quickly, place at least 400 g on each baking sheet.







¹ AID “Acrylamide” information leaflet, published by AID (German Evaluation and Information Service for Nutrition, Agriculture and Forestry) and BMVEL (German Federal Ministry for Consumer Protection, Food and Agriculture), as at 12/02, Internet: <http://www.aid.de>.

² BMVEL press release 365, as at 4.12.2002, Internet: <http://www.verbraucherministerium.de>

Test dishes

referring to EN 60350.



Baking

Food	Dish and notes	Shelf position	Cooking method	Temp. °C	Cooking time min
Small Cakes	baking tray	2		170-190	20-30
Small Cakes* (preheat oven)	baking tray	3		140-160	20-30
	baking tray + universal pan**	1+3		140-160	25-35
Fatless sponge cake	baking tin (dark coated)	2		160-180	30-40
Apple pie	2 wire racks + 2 tinplate springform cake tins Ø 20 cm	1+3, placed diagonally		190-210	70-80
	universal pan + 2 tinplate springform cake tins Ø 20 cm	1 in the centre alongside one another		200-220	70-80

* Preheat oven.

** When baking on two levels, use the universal pan provided, at shelf position three.

Grilling

Food	Dish and notes	Shelf position	Cooking method	Grill setting	Cooking time min
White bread (preheat oven 10 min)	wire rack	5		Setting 3	1-2
Beefburger*	wire rack	4		Setting 3	25-30

* Turn the burgers over after 12-15 min. Insert the universal pan at level 1.

