

SIEMENS

Making cooking as much fun as eating

Please read this instruction manual. This will ensure that you make use of all the technical benefits the cooker has to offer. You will be given important safety information. You will then be introduced to the individual components of your new cooker and we will show you how to adjust it step by step. It is quite simple.

The tables list the settings and shelf heights for numerous well-known dishes. All these dishes are tested in our cooking studio.

In the unlikely event of a fault, look here for information on how to rectify minor faults yourself.

A detailed table of contents will help you to find your way around quickly.

Enjoy your meal!

Instruction manual



HB 770.60 B

en

9000 008 859

Table of contents

| | |
|--|-----------|
| Important information | 5 |
| Before installation | 5 |
| Safety information | 5 |
| Reasons for damage | 7 |
| Your new cooker | 8 |
| The control panel | 8 |
| Control panels and displays | 9 |
| Arrows for selecting the type of heating | 10 |
| Symbols for adjusting the values set | 11 |
| Types of heating | 12 |
| Oven and shelving accessories | 15 |
| Cooling fan | 17 |
| Before using for the first time | 18 |
| Heating up the oven | 18 |
| Pre-cleaning the accessories | 18 |
| Switching the oven on and off | 19 |
| Main switch | 19 |
| Setting the oven | 19 |
| Setting procedure | 20 |
| You want the oven to switch off automatically | 22 |
| You want the oven to switch on and off automatically | 23 |
| Residual heatindicator | 24 |
| Rapid heating | 25 |
| Automatic program | 26 |
| Ovenware | 26 |
| Preparing food | 27 |

Table of contents

| | |
|--|-----------|
| Programs | 28 |
| How long will the meal take to cook? | 29 |
| Setting procedure | 30 |
| You want the oven to switch on and off automatically | 31 |
| Tips on the automatic program | 32 |
| Time | 34 |
| Setting procedure | 34 |
| Timer | 35 |
| Setting procedure | 35 |
| Basic settings | 36 |
| Changing the basic settings | 37 |
| Childproof lock | 38 |
| Automatic time limiter | 39 |
| Automatic self-cleaning | 39 |
| Setting procedure | 41 |
| You want self-cleaning to switch on and off automatically | 42 |
| When the oven has cooled | 43 |
| Care and cleaning | 43 |
| Oven exterior | 43 |
| Oven | 44 |
| Cleaning the glass panels | 45 |
| Seal | 46 |
| Accessories | 47 |
| Troubleshooting | 47 |
| Replacing the oven light | 49 |
| Replacing the oven light | 50 |

Table of contents

| | |
|---|-----------|
| After-sales service | 52 |
| Packaging and old appliances | 52 |
| Tables and tips | 53 |
| Cakes and pastries | 53 |
| Baking tips | 56 |
| Meat, poultry, fish | 57 |
| Tips for roasting and grilling | 59 |
| Frozen foods | 59 |
| Slow cooking | 60 |
| Tips on slow cooking | 62 |
| Special meals | 62 |
| Defrosting | 63 |
| Drying | 63 |
| Preserving | 64 |
| Energy saving tips | 66 |
| Acrylamide in food | 66 |
| What can you do? | 67 |
| Test dishes | 68 |

Important information

Read this instruction manual carefully. Only then will you be able to operate your cooker safely and correctly.

Please keep the instruction and installation manual in a safe place. Please pass on the instruction manual to the new owner if you sell the appliance.

Before installation

Transport damage

Check the appliance after unpacking it. Do not connect the appliance if it has been damaged in transport.

Electrical connection

The cooker may only be connected by an approved specialist. Losses resulting from damage caused by incorrect connection will invalidate warranty claims.

Safety information

Hot oven



This appliance is intended for domestic use only. Only use the cooker for food preparation.

Open the oven door carefully. Hot steam may escape. Never touch the internal surfaces of the oven or the heating elements. There is a risk of burning. Children must be kept at a safe distance from the appliance.

Never store combustible items in the oven. Risk of fire

Never clamp leads of electrical appliances in the hot oven door. The insulation on the leads could melt. There is a risk of short-circuiting.

Repairs



Incorrectly done repairs are dangerous. There is a risk of electrocution.

Repairs may only be carried out by after-sales service technicians who have been fully trained by BSH.

If there is a fault, switch off the oven fuse at the fuse box.

Call the after-sales service.

Automatic self-cleaning



Loose food residue, grease and meat juices may ignite during self-cleaning. Risk of fire. Before every self-cleaning operation, remove any coarse dirt from the oven.

Never hang flammable items, such as tea towels, on the door handle. Risk of fire.

The oven exterior will be very hot to the touch during the self-cleaning operation. Keep children at a safe distance.

Never clean metal sheets and dishes which have been coated with a non-stick coating using the oven's automatic self-cleaning function (pyrolysis operation). High temperatures can cause poisonous gases to be formed from the non-stick coating - risk of serious damage to health.

Reasons for damage

Baking tray, aluminium foil or dishes on the oven floor

Do not place the baking tray on the oven floor. Do not cover it with aluminium foil.

Do not place dishes on the oven floor.

This will cause heat accumulation. The baking and roasting times will no longer be correct and the enamel will be damaged.

Water in the oven

Never pour water directly into a hot oven. This could damage the enamel.

Fruit juice

When baking very moist fruit cakes, do not put too much on the baking sheet. Fruit juice dripping from the baking sheet leaves stains that cannot be removed.

It is recommended that you use the deeper universal pan.

Cooling with the oven door open

Only leave the oven to cool with the door closed. Do not allow anything to become trapped in the oven door. Even if you only leave the oven door open slightly, the fronts of adjacent units may become damaged over time.

Very dirty oven seal

If the oven seal is very dirty, the oven door will no longer close properly when the oven is in use. The fronts of adjacent units could be damaged. Keep the oven seal clean.

Using the oven door as a seat

Do not stand or sit on the oven door.

Your new cooker

Here you will learn more about your new oven. The control panel and its switches and indicators are explained here. The heating modes and the accessories included with your oven will be explained here.

The control panel

Details vary according to the appliance model.

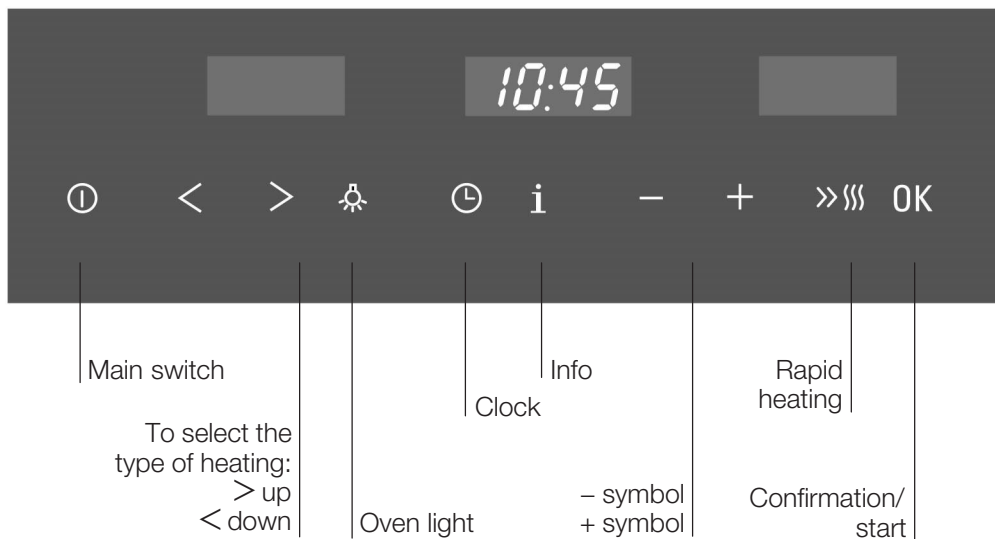

Control panels and displays

There are sensors underneath the individual control panels. Touch the relevant symbol with your index finger.

| Symbol | | |
|--------|--|---|
| ⓘ | Main switch | This is used to switch the oven on and off. |
| <> | Arrows for selecting the type of heating | Use these arrows to select the type of heating: > up < down |
| 💡 | Oven light | Use this symbol to switch the oven light on and off. |
| 🕒 | Clock | Use this symbol to set the time, the timer ⏰, the duration → and the end time → . |
| i | Info | You can use this symbol to call up the heating temperature and the weight set for the automatic program. |
| - + | Symbols for adjusting the values set | Use these symbols to adjust the default values and values set: - symbol = to set a lower value + symbol = to set a higher value |
| »»» | Rapid heating | Use this symbol to heat up the oven quickly. |
| OK | Confirmation/start | Use this symbol to confirm a setting or to start the oven. |

The values set can be seen in the display. Settings can be made as long as a symbol in the display is flashing.

Important

The setting will be cleared after a few minutes if you do not start the oven using the OK symbol. Always start the oven using the OK symbol.

The rise in temperature or the residual heat in the oven is shown in the preheating indicator below the temperature display.

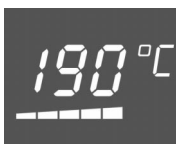

Arrows for selecting the type of heating

You can select the type of heating for the oven using the > up or < down arrows.

Touch the relevant arrow until the type of heating required appears in the display.

A default value appears in the temperature display for each type of heating.

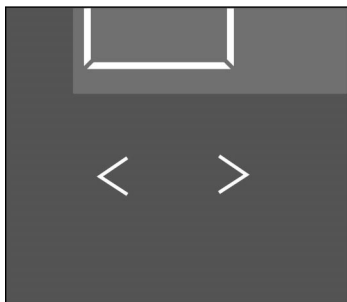

Settings

| | |
|---|---------------------------------|
| | Top/bottom heating |
| | Conventional baking* |
| | Intensive heat |
| | 3D hot air |
| | Intensive hot air/pizza setting |
| | Bottom heating |
| | Hot air grilling |
| | Radiant grill - small area |
| | Radiant grill - large area |
| | Defrost |
| | Automatic self-cleaning |
| P | Automatic program |

*Type of heating with energy efficiency class determined in accordance with EN50304.

Oven light

The oven light switches on when you select a type of heating.

Exceptions:

The light will not come on during defrosting at temperatures between 30 and 60 °C or during the automatic self-cleaning process.

If the oven is set to switch on and off automatically, the oven light will only come on after the oven is switched on.

You can switch the light off and on again using the oven light symbol.

Exception: Defrosting at 20 °C.

Symbols for adjusting the values set



You can adjust all default values and values set using the + symbol or – symbol.

+ = to set a higher value

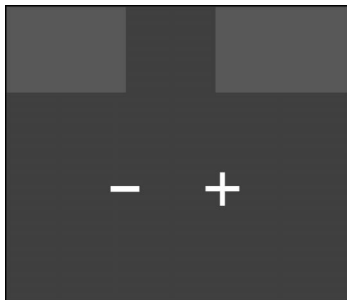
– = to set a lower value



Ranges

| | |
|-----------------|--|
| 50 - 300 | Temperature in °C Maximum temperature for 3D hot air  and intensive hot air/pizza setting  = 270 °C Defrost at temperatures between 20 and 60 °C |
| 1 - 3 | Grill levels |
| 1 - 3 | Cleaning levels |
| 1 min - 23.59 h | Duration |
| 1 sec - 23.55 h | Timer period |
| P 1 - P 26 | Programs |

Types of heating

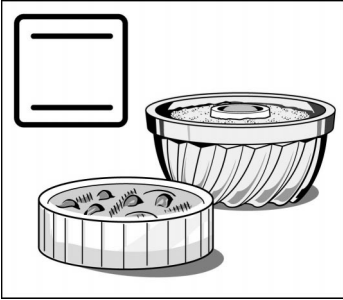

Different types of oven heating are available. You can therefore select the best method for cooking any dish.

Top and bottom heating

This ensures the even distribution of heat onto the cake or roast from the top and bottom of the oven. This type of heating is best for cake mixtures in tins or for bakes. Top and bottom heating is also suitable for cooking lean roasts of beef, veal and game. Gentle cooking in the 70 °C to 100 °C temperature range makes all tender meat particularly juicy.

To keep food warm : You can keep food warm in the 65-100 °C temperature range. Do not keep food warm for longer than two hours.

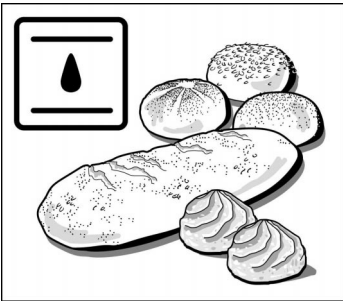

Conventional baking

is the most energy-efficient type of heating. This type of heating also ensures even distribution of heat to the food from the top and bottom of the oven. The moisture extracted during the baking is retained as steam in the oven. The food does not dry out. Leavened food such as bread, bread rolls or plaited loaves turn out especially well when cooked using this type of heating. This type of heating is also best for cooking choux pastries such as cream puffs.

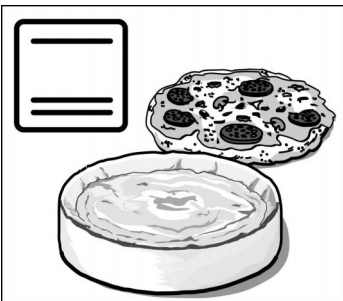

Intensive heat

Due to the intensive heat from below, foods such as pizza will acquire a particularly crispy base. It is no longer necessary to preheat the oven to bake spiced cakes and savoury pies such as quiche lorraine. Intensive heat is also the ideal type of heating when baking in moulds made from tin, glass or porcelain, which tend to reflect heat or are poor conductors of heat.

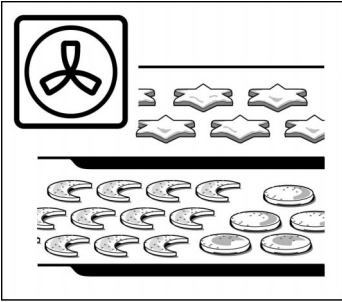

3D hot air

A fan in the rear panel distributes the heat from the ring heating element evenly inside the oven. Using 3D hot air, it is possible to bake cakes and pizza on two shelves. You can cook cookies and puff pastry on three levels at the same time. The required oven temperatures are lower than those for top and bottom heating. Additional baking trays may be obtained from specialist shops. 3D hot air is ideal for drying food.



Pizza setting/intensive hot air

This type of heating uses bottom heating and the ring heating element. This type of heating is particularly suitable for deep-frozen foods. It is ideal for cooking pizzas, chips or strudels, without requiring preheating.

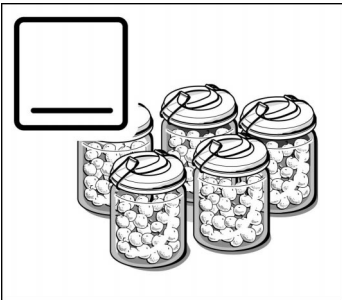

Bottom heating

You can reheat or brown meals using bottom heating. It is also the most suitable type of heating for preserving food.

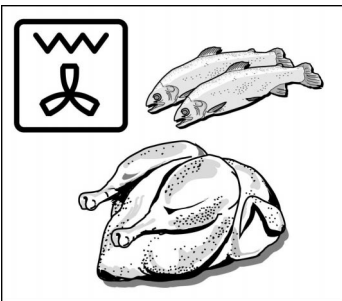

Hot air grilling

This type of heating involves the grill element and the fan alternating between on and off. During the pause in heating, the fan circulates the heat generated by the grill around the food. This ensures that cuts of meat are crisped and brown on all sides.

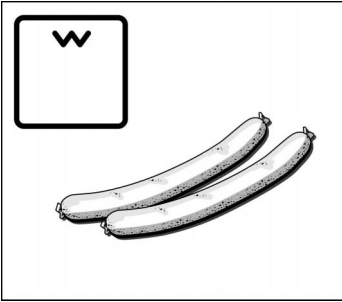

Radiant grilling, small area

This involves only the middle section of the grill heating element being switched on.

This type of heating is ideal for cooking small quantities. This saves energy. Place the pieces to be grilled in the centre of the wire grill.

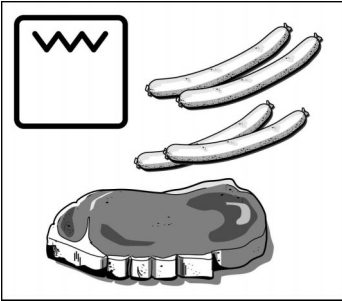

Radiant grilling, large area

The entire area under the grill element becomes hot.

This is ideal if you wish to cook several steaks, sausages, fish or slices of toast.

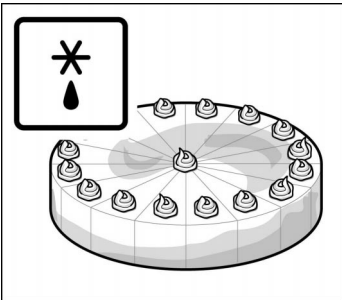

Defrost

A fan in the rear wall of the oven circulates the air in the oven around the frozen food. Frozen pieces of meat, poultry, bread and cakes defrost evenly.

Notes

Heating is interrupted if you open the oven door while the oven is in operation.

To ensure that the heat is well distributed, the fan switches on for a short time during preheating for types of heating with top and bottom heating.

Oven and shelving accessories

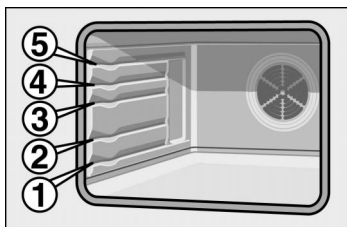

The shelf can be inserted at 5 different heights in the oven.

You can remove the shelf two thirds of the way without it tipping. This makes it easier to take food out of the oven.

Accessories

Accessories may be purchased at a later date from the after-sales service or from specialist shops. Please specify the HZ number.

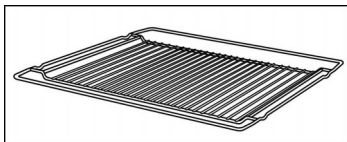

HZ 334001 wire racks

For ovenware, cake tins, roasts, grilling and frozen meals.

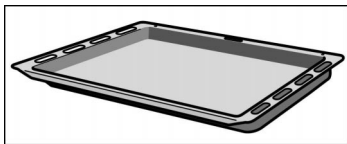

Universal pan HZ 332070

for moist cakes, pastries, frozen food and large roasts. It can also be used to catch dripping fat when you are grilling directly on the wire grill.

Push the universal pan with the sloping edge facing towards the oven door.

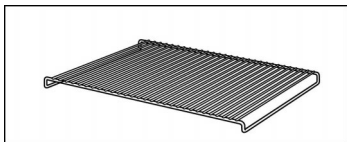

HZ 324000 wire rack

for grilling. Always place the wire grill in the universal pan. Fat and meat juices are collected.

Optional accessory

Optional accessories may be purchased from the after-sales service or from specialist shops.

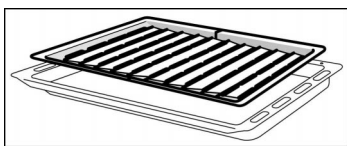

Grill pan HZ 325070

Can be used for grilling instead of the wire grill or as a spray guard to protect the oven against dirt. Only use the grill pan in the universal pan.

To grill using the grill pan: use the same shelf height as for the wire grill.

Using the grill pan as a spray guard: insert the universal pan with the grill pan under the wire grill.

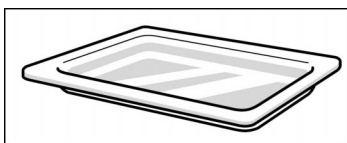

Glass pan HZ 336000

A deep baking tray made from glass. Can also be used as a serving dish.

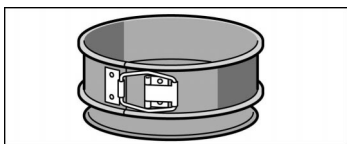

Baking tin HZ 26001

You can bake especially moist cakes using the leak-proof baking tin. The extra wide rim prevents leakage and your cooker stays clean.

The baking tin has a non-stick coating on the inside.

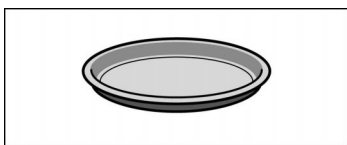

Pizza tray HZ 317000

Ideal for pizza, frozen foods and large round cakes, for example. You can use the pizza tray instead of the universal pan. Place the tray on the wire grill. Observe the information provided in the tables.

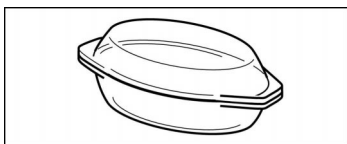

Glass roasting dish HZ 915000

for braised dishes and bakes that are cooked in the oven. It is especially suitable for the automatic roasting function.

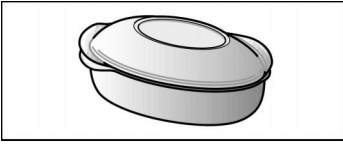

Metal roasting dish HZ26000

It is intended for use in the extended cooking zone of the glass ceramic hob. The dish is suitable for the sensor cooking system as well as for the automatic roasting function.

The roasting dish is enamel on the outside and has a non-stick coating on the inside.

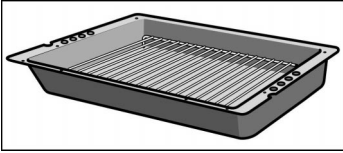

Profi extra-deep pan HZ 333070

for cooking large quantities of food.

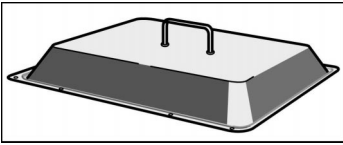

Lid for the Profi extra-deep pan HZ 333001

Converts the Profi extra-deep pan into the Profi roasting dish.

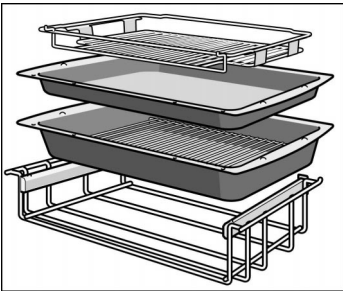

Profi oven drawer Plus HZ 333102

To be used for preparing large quantities of food. A deep pan, a shallow pan, a wire rack, a wire rack for placing on top and a telescopic shelf come as accessories.

You can grill foods very well using the wire rack placed on top of the drawer.

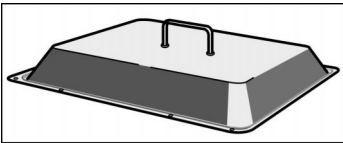

Lid for the Profi extension HZ 333101

Converts the Profi extra-deep pan into the Profi roasting dish.

Cooling fan

The oven is fitted with a cooling fan. It switches itself on and off as necessary. The warm air escapes above the door.

Before using for the first time



This section tells you everything you need to do before using the cooker for the first time.

Heat the oven and clean the accessories. Read the safety instructions in the “Important information” section.

Firstly, check to see if the  symbol and three zeros are flashing in the display.

If the  symbol and three zeros are flashing in the display





Set a time.

1. Touch the  clock symbol.
12:00 appears and the  clock symbol flashes in the display.
2. Set the current time with the – or + symbol.
3. Confirm with the OK symbol.
The oven is ready for operation.

Heating up the oven

Heat the empty oven with the door closed to remove the new oven smell.

Method

1. Touch the  main switch until the  symbol appears in the display.
2. Set  top/bottom heating. To do this, touch the > up arrow until the  symbol appears in the display.
3. Touch the + symbol until 240 °C appears in the temperature display.
4. Start the oven by touching the OK symbol.

Switch the oven off after 60 minutes using the  main switch.

Pre-cleaning the accessories

Please wash the accessories thoroughly with soapy water and a cleaning cloth before using them.

Switching the oven on and off

Main switch

Switching on

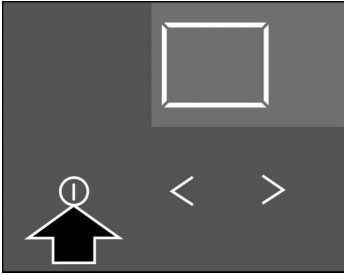

The ① main switch is used to switch the oven on and off.

Touch the ① main switch until the □ symbol appears in the display.

The main switch switches off automatically if you do not set the oven within the next few minutes. The □ symbol goes out.

Switching off

Touch the ① main switch until the setting disappears.

The time, any timer period set and, if applicable, the residual heat indicator are independent of the main switch.

Setting the oven

You have various options for setting the oven.

Switching off the oven manually

When your meal is ready, switch off the oven yourself.

The oven switches off automatically

You can leave the kitchen for a long period.

The oven switches on and off automatically



You can put your meal in the oven in the morning, for example, and set the oven so that your meal is ready at midday.

Tables and tips

The correct settings for many dishes can be found in the Tables and tips section.

Setting procedure

Example: Top/bottom heating , 190 °C

1. Switch on the  main switch. The  symbol lights up in the display.
2. Set the required type of heating with the < down or > up arrow.

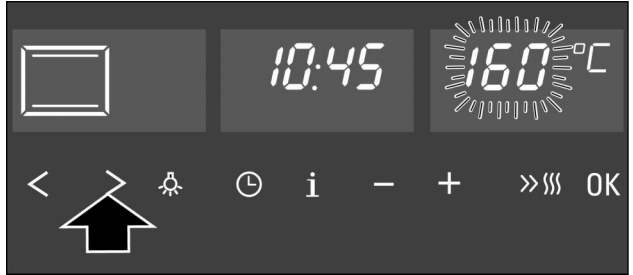

3. Set the desired temperature or grill setting with the - or + symbol.



4. Start the oven by touching the OK symbol.



Short beep

If you forget to start the oven, a short beep reminds you after a few seconds that you must touch the OK symbol to start.

Switching off

Switch off the  main switch when the meal is ready.

Changing the setting

You may change the type of heating, temperature or grill setting at any time. Confirm the change by touching the OK symbol.

Preheating indicator



The preheating indicator provides a visual display of the oven temperature increase. It is best to insert the dish in the oven when all segments are lit.

The preheating indicator does not appear during grilling and defrosting (20 °C).

While the oven is heating up, you can call up the current heating temperature with the **i** Info button. It appears in the display for a few seconds. The heating temperature does not appear if you are grilling.

The thermal inertia of the oven means that a temperature may be displayed during the heating up phase which differs from the actual oven temperature.

You want the oven to switch off automatically

5. Touch the ⌚ clock symbol repeatedly until the ⌚ duration symbol flashes in the display.

Set as described in points 1 to 4. Set the duration (cooking time) for your meal.

Example: for a duration of 45 minutes



6. Set the required duration with the - or + symbol.

+ plus
default value = 30 min.
- minus
default value = 10 min.



7. Start with the OK symbol or extend the end time, as described under the section entitled "You want the oven to switch on and off automatically".

The ⌚ duration symbol lights up in the display when you start the oven by touching the OK symbol.

The duration has elapsed

A signal sounds. The oven switches off. 0:00 is shown in the clock display. You can cancel the signal in advance by touching the ⌚ clock symbol. The time appears again when you switch off the ⌚ main switch.

Clearing the duration

Touch the ⌚ clock symbol repeatedly until the I→ duration symbol flashes. Touch the – symbol until zero appears in the display. Touch the OK symbol. The oven is interrupted if it is in operation.

Changing the setting

Touch the ⌚ clock symbol. Change the duration with the + or – symbol. Confirm with the OK symbol.

Cancelling the setting

Switch off the Ⓜ main switch.

Calling up settings

To call up the end time →I or time ⌚: touch the ⌚ clock symbol until the relevant symbol appears in the display. The value called up will then appear in the display for a few seconds.

You want the oven to switch on and off automatically

Please remember that foods which spoil easily must not be allowed to remain in the oven for too long.

Example: the time is 10:45. The meal will take 45 minutes to cook and must be ready at 12:45 pm.

Set the oven as described in steps 1 to 6. The oven should not be switched on yet.

7. Touch the ⌚ clock symbol. The →I end time symbol flashes. In the display you will see the time when the meal will be ready.

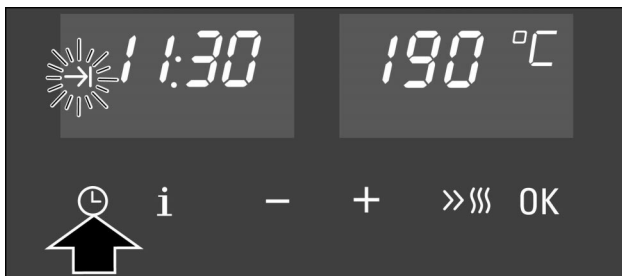

8. Extend the end time with the + symbol.



9. Confirm with the OK symbol.

The display will show the end time until the oven is switched on. The duration then counts down in the display.

The duration has elapsed

A signal sounds. The oven switches off. 0:00 is shown in the clock display. The time appears again when you switch off the ⓐ main switch.

Note

You can change the settings as long as a symbol in the display goes out. When the symbol lights up, the setting has been adopted. You can change the time before which a setting is adopted. See the Basic settings section for more details.

Residual heat indicator

When you switch off the oven, the residual heat in the oven is indicated in the preheating indicator. When all segments are lit, the temperature in the oven is approximately 300 °C.

The preheating indicator goes out when the temperature has fallen to approximately 60 °C.

Using the residual heat







You can keep food warm in the oven using the residual heat.

For meals with long cooking times, you may switch off the oven 5 to 10 minutes earlier. The residual heat will finish cooking the meal, thereby saving energy.

Rapid heating

This allows you to preheat the oven particularly quickly.

You may use the rapid heating function with the following types of heating:

-  = Top/bottom heating
-  = Conventional baking
-  = Intensive heat
-  = 3D hot air
-  = Pizza setting
-  = Hot air grilling

Method

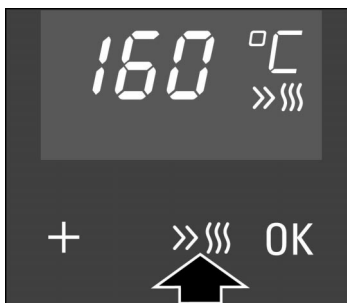

Set the oven as required.



Touch the  rapid heating symbol.

The  symbol lights up in the temperature display.

The oven will heat up. The segments of the preheating indicator will light up.

When all segments of the preheating indicator are lit, a signal sounds and the  symbol goes out. Place the food in the oven.

Cancelling the rapid heating function

Touch the  rapid heating symbol. The  symbol goes out in the temperature display.

Notes

The rapid heating function will not work if the temperature set is below 100 °C. If the temperature in the oven is only slightly below the temperature set, the rapid heating function is not necessary. It will not switch on.

The rapid heating function is interrupted if you change the type of heating.

You can call up the current heating temperature during rapid heating. Touch the  Info symbol. The temperature appears for several seconds in the display.

Automatic program

Using the automatic program, you will be able to produce delicious braised meals, juicy roasts and tasty stews without the need for turning or basting the meat which, in turn, keeps your oven clean.

Ovenware

The automatic program is only suitable for roasting in a covered dish. Only use a roasting dish with a suitable lid.

Suitable dishes

Suitable dishes are heat-resistant (up to 300 °C), glass or glass ceramic dishes.

Add more liquid when roasting in enamelled steel, cast-iron or pressed aluminium dishes. The base of the pan should be covered by liquid to at least ½ cm. The food will brown more.

Please observe the instructions of the dish manufacturers.

Stainless steel dishes are only suitable in some cases. The food will not brown as much and the meat will not cook as well.

Unsuitable dishes

Dishes made of shiny aluminium, unglazed clay or dishes with plastic handles are not suitable.

Dish size

The meat should cover around two thirds of the base of the dish. This ensures that the meat juices turn out well.

There should be at least 3 cm between the meat and the lid. The meat may expand while roasting.

Preparing food

Select a suitable dish.

Weigh the fresh or deep-frozen meat, the fish or the vegetables if it is a vegetarian dish. You need this weight to adjust cooking times etc.

Cover the dish with the lid. Place it on the wire grill at shelf position 2.

Meat

If indicated in the program table, add liquid to the empty dish. The base of the dish must be covered.

Season meat, place it in the dish and close with the lid.

Fish

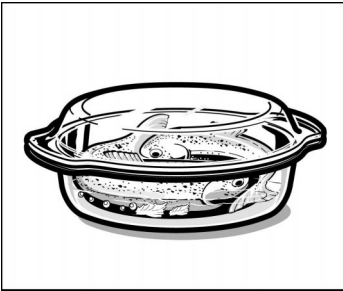

Clean the fish and add lemon juice and salt to taste.

Steamed fish: Add the fluid, e.g. wine or lemon juice, to a depth of ½ cm.

Baked fish: Toss the fish in flour and coat with melted butter.

Note: Fish cooks best when placed in the “swimming position” in the dish.

Stew

You can combine different kinds of meat and fresh vegetables.

Cut the fish into bite-size pieces. Do not cut up chicken portions.

Add up to twice the amount of vegetables to meat.

Example: Use between 0.5 kg and 1 kg fresh vegetables for 0.5 kg meat.

Always put the meal into the cold oven.

Programs

| Fresh meals | Use for | Program number | Weight range | Add liquid |
|---------------------------|---|-----------------------|---------------------|-------------------|
| Beef: pot-roast | Spare ribs, shoulder, sides, braised marinated beef | 01 | 0.5-3.0 kg | Yes |
| Sirloin | | 02 | 0.5-2.5 kg | No |
| Sirloin, rare | | 03 | 0.5-2.5 kg | No |
| Roast pork | Neck, collar, sides, thick flank, fillet | 04 | 0.5-3.0 kg | Yes |
| Roast pork with crackling | Shoulder with rind, belly | 05 | 0.5-2.0 kg | No |
| Ham | | 06 | 0.5-2.5 kg | Yes |
| Leg of lamb | Boned | 07 | 0.5-2.5 kg | Yes |
| Leg of lamb, medium rare | Boned | 08 | 0.5-2.5 kg | No |
| Poultry | Chicken, duck, goose, baby turkey | 09 | 0.5-2.5 kg | No |
| Poultry drumsticks | Chicken, turkey, duck, goose drumsticks | 10 | 0.3-1.5 kg | No |
| Turkey breast | Turkey breast, fillet | 11 | 0.5-2.5 kg | Yes |
| Mutton, venison | Shoulder, neck, breast | 12 | 0.5-2.5 kg | Yes |
| Gammon, venison, sm.game | Leg of venison, leg of hare | 13 | 0.5-3.0 kg | Yes |
| Meat loaf | Beef/pork meatloaf | 14 | 0.3-3.0 kg | No |
| Stews | Roulade, meat and vegetable stew, Szegedin goulash | 15 | 0.3-3.0 kg | Yes |
| Steamed fish | Trout, pike-perch, carp, whole cod | 16 | 0.3-1.5 kg | Yes |
| Baked fish | Trout, pike-perch, carp, whole cod | 17 | 0.5-1.5 kg | No |

| Frozen meals* | Use for | Program number | Weight range | Add liquid |
|------------------------|---|----------------|--------------|------------|
| Beef: pot-roast | Spare ribs, shoulder, sides | 18 | 0.5-2.0 kg | Yes |
| Beef, medium | Roast beef, spare rib | 19 | 0.5-2.0 kg | No |
| Roast pork | Neck, collar, sides, thick flank, fillet | 20 | 0.5-2.0 kg | Yes |
| Roast veal | Shoulder, shank, thick flank, topside, stuffed breast of veal | 21 | 0.5-2.0 kg | Yes |
| Leg of lamb | Boned | 22 | 0.5-2.0 kg | Yes |
| Leg of lamb, med. rare | Boned | 23 | 0.5-2.5 kg | No |
| Poultry drums | Chicken, turkey, duck, goose drumsticks | 24 | 0.3-1.5 kg | No |
| Mutton, venison | Shoulder, neck, breast | 25 | 0.5-2.0 kg | Yes |
| Small game | Leg of venison, leg of hare | 26 | 0.5-2.0 kg | Yes |

* Important: If preparing frozen meat, extending the end time is not recommended. The meat would thaw out before the program starts and would be inedible.

How long will the meal take to cook?

So that you know how long the meal will take to cook, set the oven as described in steps 1 to 6. The duration will appear in the display.

To interrupt the program: change the type of heating or switch off the ① main switch.

Setting procedure

Select the appropriate program from the program table.

Example: well-done roast beef, 1.2 kg, program P2.

1. Switch on the ① main switch.
2. Select the automatic program with the > up or < down arrow. P appears in the display.

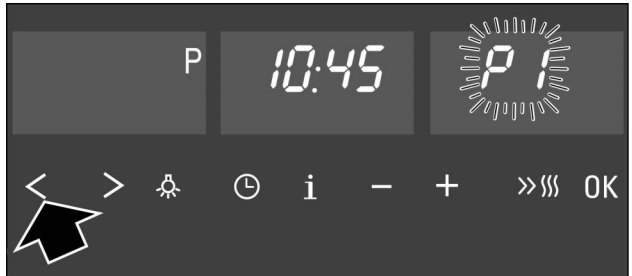

3. Set the program number required with the + symbol.



4. Confirm with the OK symbol. The default weight appears in the clock display.
5. Set the weight with the + or - symbol.

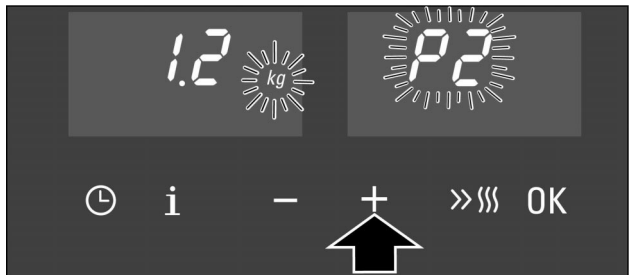

6. Confirm with the OK symbol.
7. Start the program with the OK symbol or extend the end time as subsequently described.

The duration has elapsed

A signal sounds. The oven switches off.
The time appears again when you switch off the
Ⓛ main switch.

Cancelling the program

Change the type of heating or switch off the Ⓛ main switch.

You want the oven to switch on and off automatically

Only use fresh meat or fresh fish.

Do not leave the food to stand in the oven for too long. Meat and fish will spoil easily when not in the refrigerator.

Example: program P2. You want the meal to be ready by 12:15.

Set the oven as described in steps 1 to 6.

7. While the set program is flashing, touch the Ⓛ clock symbol until the → end time symbol flashes.

In the display you will see the time when the meal will be ready.

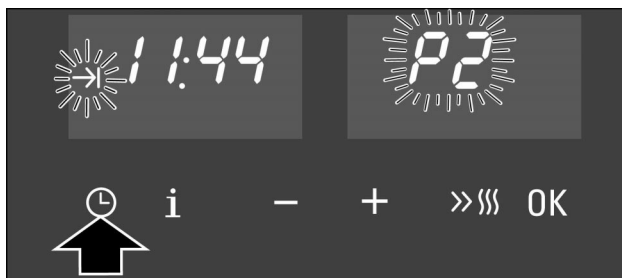

8. Extend the duration with the + symbol.



9. Confirm with the OK symbol.

The end time is shown in the display. The → end symbol lights up. The oven switches on at the appropriate time.

The duration has elapsed



A signal sounds. The oven switches off. The time appears again when you switch off the  main switch.

Note

To call up the weight: Touch the  Info symbol. The weight appears for a few seconds in the display after the program has started.

Tips on the automatic program

The weight of meat or poultry exceeds the specified weight range

The weight range is deliberately limited. It is rare to find roasting dishes of sufficient size for cooking large pieces of meat. Cook large pieces of meat using top/bottom heating  or hot air grilling .

The meat is good, but the juices are too dark

Use a smaller dish and more liquid.

The meat is good, but the juices are too clear and watery.

Use a larger dish and less liquid.

The top of the roast is too dry.

Use a roasting dish with a firmly fitting lid. Very lean meat stays juicier if it is covered with bacon rashers.

While the meat is roasting, it smells as though it is burning even though the meat looks good.

The lid on the roasting dish is not properly closed or the meat has risen and raised the lid. Always use a suitable lid. Ensure that there is a minimum distance of 3 cm between the meat and the lid.

You want to cook frozen meat

Season the frozen meat in exactly the same way as fresh meat. N.B. The end time cannot be set to a later time if cooking meat from frozen. The meat would defrost before the program starts.

You want to roast several chicken drumsticks or other poultry drumsticks at the same time

The drumsticks must be of approximately the same size. Enter the weight of the heaviest drumstick. Example: Two turkey drumsticks weighing 1.4 and 1.5 kg. Enter 1.5 kg.

You want to poach or bake several fish at the same time

The fish must be approximately the same size. Enter the total weight. Example: Two trout weighing 0.6 and 0.5 kg. Enter 1.1 kg.

| | |
|---|---|
| You want to cook stuffed poultry | This method of cooking is not suitable for stuffed poultry. This is best cooked uncovered on the wire grill. Look up poultry in the table. |
| The meat in the stew is not sufficiently browned | Next time place the pieces of meat around the edge of the dish. Place the vegetables in the middle. |
| The vegetables in the stew are too hard | When cooking a stew, enter the weight of the meat. This ensures that the vegetables are crunchy. If you want the vegetables to be softer, enter the combined weight of the vegetables and meat. |
| You want to cook a vegetarian stew | Only use firm vegetables, such as carrots, green beans, white cabbage, celery and potatoes. The smaller you cut the vegetables, the softer they will be. Cover the vegetables with liquid to prevent them from browning excessively. |
| You wish to use your stainless steel roasting dish | The stainless steel dish is only suitable to a certain degree. The shiny surface reflects much of the heat radiation. The meal will not brown as much and the meat will be less well done. If you use the stainless steel roasting dish: Remove the lid once the program has ended. Grill the meat at grill setting 3  for a further 8 to 10 minutes. |

Time

When the oven is first connected or following a power cut, the ⌚ symbol and three zeros flash in the display. Set a time.

Setting procedure

Example: 13:00

1. Touch the ⌚ clock symbol. 12.00 appears in the display and the ⌚ symbol flashes.

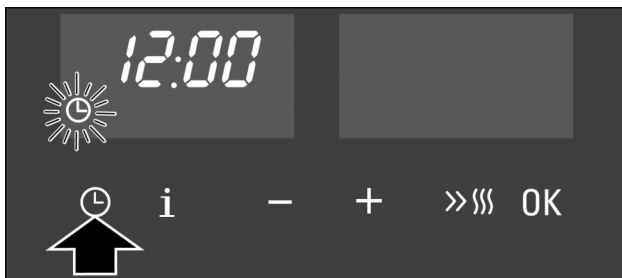

2. Adjust the time using the – or + symbol.



3. Confirm by pressing OK. The time appears. The ⌚ symbol will go out.

Changing the time e.g. from summer to winter time

The oven must be switched off. Touch the ⌚ clock symbol repeatedly until the ⌚ symbol flashes in the display. Adjust the time using the – or + symbol. Confirm by pressing OK.

Hiding the time

You can adjust the setting for the time so that it is only shown when the oven is in operation. To do this, you must change the basic setting. See the Basic settings section.

Timer

You can use the timer as a kitchen timer. It operates independently of the oven.
The timer has a special signal.

Setting procedure

Example: 20 minutes

1. Touch the ⌚ clock symbol repeatedly until the ⚠ timer symbol appears in the display.

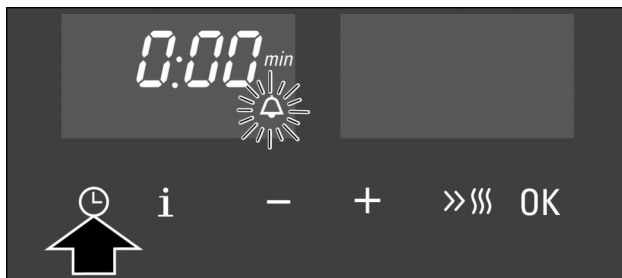

2. Set the timer period with the – or + symbol.

+ plus
default value = 10 min.
– minus
default value = 5 min.



3. Start the timer with the OK symbol.
The time counts down visibly.

The time has elapsed

A signal sounds. Touch the ⌚ clock symbol. The timer display will go out.

Changing the timer period

Touch the ⌚ clock symbol. The ⚠ symbol will flash.
Change the time with the + or – symbol.
Start with the OK symbol.

Canceling the setting

If you switch off the main switch, the timer continues as set.

Touch the ⌚ clock symbol. Reset the time to 0:00 with the – symbol. Confirm with the OK symbol. The time reappears in the display.

The timer and duration count down simultaneously

Both symbols light up in the display. The timer period counts down in the display.

To call up the duration I→I, end time →I or time ⌚: touch the ⌚ symbol repeatedly until the I→I or →I symbol or the time ⌚ appears.

The value called up will then appear in the display for a few seconds.

Basic settings

Your oven has several basic settings. You can adapt these settings to your own preferences.

| | Function | Option 1 | Option 2 | Option 3 |
|------|--|------------------------------|---|--------------------------|
| In 1 | Time in the clock display | The time is always displayed | The time is only shown when the oven is in operation* | – |
| In 2 | Signal duration after a set time has elapsed | Short | Medium | Long |
| In 3 | Adoption time for adjustment increments | Approximately 20 seconds | Approximately 30 seconds | Approximately 40 seconds |
| In 4 | The cooling fan runs on until the oven reaches a certain temperature | Short run-on time | Moderate run-on time | Long run-on time |
| In 5 | Display brightness | Dim | Moderate | Bright |
| In 6 | Reminder when starting up the oven | Off | On | – |

| | Function | Option 1 | Option 2 | Option 3 |
|------|--------------------------------|-------------|-----------|----------|
| In 7 | Childproof lock with door lock | Deactivated | Activated | – |

* Exception: The time is shown when the residual heat is displayed.

Changing the basic settings

There must be no program set.

Example: The time is only shown when the oven is in operation

1. Touch the **i** Info symbol until **In 1** appears in the display.

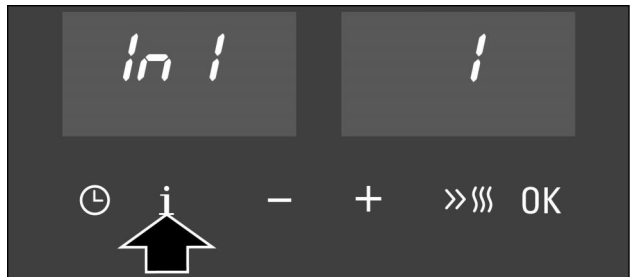

2. Adjust the basic setting using the + or – symbol.

All setting levels can be scrolled through using the **i** Info symbol and altered using the + or – symbol. Press OK to confirm that you have finished adjusting the settings.

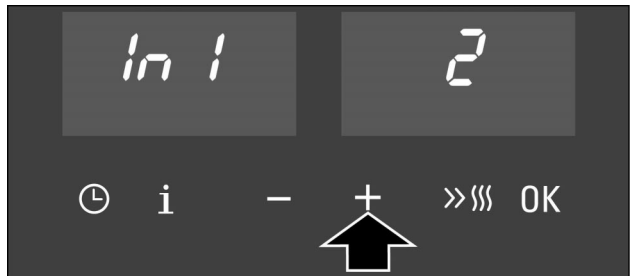

Correction

You may change your settings again at any time.

Childproof lock

The oven has a childproof lock to prevent children switching it on accidentally or changing the setting.

Activating the childproof lock

Touch the OK symbol until the  key symbol lights up in the display.

The oven can no longer be set. A setting cannot be changed.

N.B. The current setting will be deleted if you touch the  main switch symbol. The childproof lock remains activated.

Locking the oven door

You may change the basic settings so that the oven door is also locked. See the “Basic settings” section for how to do this.

If you activate the childproof lock during oven operation, the oven door will lock if the temperature inside the oven is higher than 50 °C. The  symbol also appears in the display.

Unlocking

Touch the OK symbol until the  key symbol in the display goes out. You can operate the oven again.

Note

The  symbol will flash in the display if you attempt to make settings on the oven when the childproof lock is activated. Release the lock.

Automatic time limiter

If you have forgotten to switch off the oven, the automatic time limiter will be activated. Oven operation will be interrupted. The time when this happens depends on the selected temperature or grill setting.

A 5 appears in the display when the oven is no longer heating up. If the heating function is interrupted a signal sounds.

The heating function is interrupted until you switch off the ① main switch. The 5 will disappear. Now you can reset the oven.

Cancelling the automatic time limiter

If you enter a duration, the oven will then switch off at the required time.

The time limiter is cancelled.

Automatic self-cleaning

The oven is heated to approximately 500 °C. Any food residues from roasting, grilling and baking are burnt to ash.

You may choose from three cleaning levels.

| Level | Degree of cleaning | Duration |
|-------|--------------------|-----------------------|
| 1 | Low | approx. 1¼ hours |
| 2 | Medium | approx. 1½ hours |
| 3 | Intensive | approximately 2 hours |

What you should know

For safety reasons, the oven locks automatically. You can only open the oven door again when the  locking symbol in the display goes out.



The exterior of the oven will become very hot. Make sure that nothing is placed against the front panel. Keep children at a safe distance.

If you open the oven again after automatic self-cleaning begins, the locking latch may be visible at the top of the oven. This is normal. The latch disappears automatically when you close the door again. Please do not attempt to push in the latch by hand.

You cannot switch the oven light on during automatic self-cleaning. The preheating indicator does not appear.

Before automatic self-cleaning

Remove unsuitable accessories and all ovenware from the oven.



Risk of fire. Loose food residue, grease and meat juices are flammable.

Wipe the oven and the accessories that are to be cleaned at the same time with a damp cloth.

Clean the oven door and along the edges of the oven around the seal. Do not scour the seal.

Cleaning accessories at the same time

Insert the universal pan at shelf position 2 for self-cleaning.



The wire grill is not suitable for self-cleaning.



Never clean metal sheets and dishes which have been coated with a non-stick coating using the oven's automatic self-cleaning function (pyrolysis operation). High temperatures can cause poisonous gases to be formed from the non-stick coating - risk of serious damage to health.

Setting procedure

Example: cleaning level 2

1. Switch on the  main switch.
2. Select automatic self cleaning  with the > up or < down arrow.

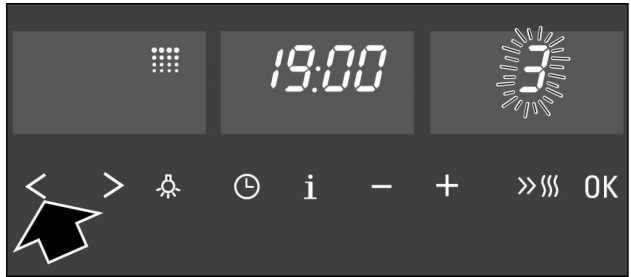

3. Set the cleaning level required with the - or + symbol.

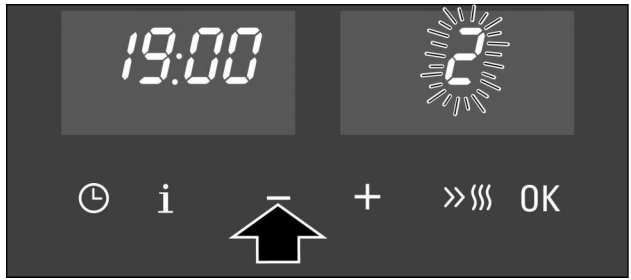

4. Start with the OK symbol. The time reappears in the clock display.



The cleaning time has elapsed

The oven switches off automatically.

The symbol lights up

The oven becomes very hot and is locked for your safety. The oven door will only open when the  symbol goes out.

Calling up the duration and end time

To call up the duration  or end time : Touch the  symbol repeatedly until the relevant symbol appears.

You want self-cleaning to switch on and off automatically

You can also set the oven so that cleaning runs at night, for example. Then the oven is available for use at any time during the day.

Example: You want automatic self-cleaning to be finished at 23:00.

Set the oven as described in steps 1 to 3.

4. Touch the ⌚ clock symbol immediately. The →| end time symbol flashes.

The display shows when automatic self-cleaning will be finished.

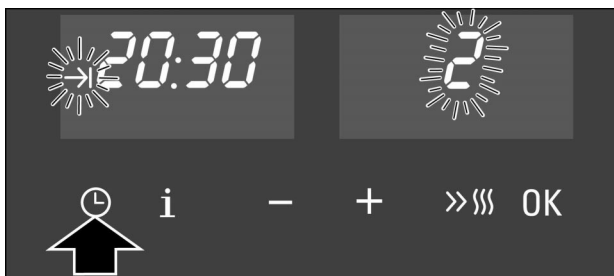

5. Extend the duration with the + symbol.



6. Confirm with the OK symbol.

The self-cleaning function switches on and off at the appropriate times. The time reappears once self-cleaning has started.

The cleaning time has elapsed

The oven switches off automatically.

Canceling the setting

Change the type of heating or switch off the ① main switch. The oven door can only be opened when the 🔒 symbol is flashing in the display.

Note

The cleaning level can no longer be changed once the cleaning operation has been started.

When the oven has cooled

Wipe away any remaining ash from inside the oven using a moist cloth.

Note

Under normal use, it is usually sufficient to clean the oven every two or three months. Only about 2.5-4.7 kilowatt hours are required for each self-cleaning process.

The special heat-resistant enamel and the shiny parts in the oven may become dull or discoloured after time. This is normal and does not affect the function. Do not use coarse scouring pads or strong cleaning agents to remove such discolorations.

Care and cleaning

Do not use high-pressure cleaners or steam jets.

Oven exterior

Wipe the oven with water and a little washing-up liquid. Dry it with a soft cloth.

Caustic or abrasive substances are not suitable. If any such substances come into contact with the frontage, wipe it off immediately with water.

Note

Slight differences in the colours on the appliance front are caused by the use of different materials, such as glass, plastic and metal.

Shadows on the door panel which resemble smears are reflections from the oven light.

Appliances with stainless steel fronts

Always remove any flecks of limescale, grease, cornflour and egg white immediately. Corrosion can form under such flecks.

Use stainless steel care products. Follow the manufacturer's instructions. Try out the product on a small area first, before using on the whole surface.

Appliances with aluminium fronts

Use a mild window-cleaning detergent. Wipe the area with a soft window cloth or a fluff-free micro-fibre cloth, using a horizontal action without applying pressure.

Aggressive cleaning products, scratchy sponges and rough cleaning cloths are not suitable.

Oven

Never use coarse scouring pads or cleaning sponges. Oven cleaner may only be used on enamelled oven surfaces.

For ease of cleaning

the oven door can be detached:

Detaching the oven door

The oven door can be easily detached.

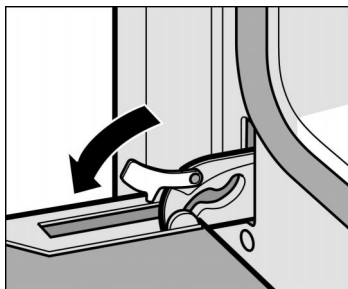

1. Open the oven door fully.
2. Move the two locking levers on the left and right-hand sides.

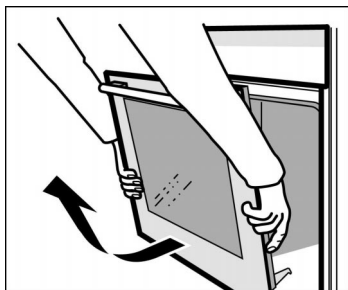

3. Half-close the oven door.
With both hands, grip the bottom of the door on the left and right-hand sides.
Close the door a little more and pull it out.

After cleaning, re-install the oven door, following the instructions in reverse order.

Cleaning the enamelled surfaces of the oven

Use hot soapy water or a vinegar solution.

It is best to use oven cleaner if the oven is very dirty. Only use oven cleaner in a cold oven.

Note:

Enamel is baked on at very high temperatures. This can cause some slight colour variation. This is normal and does not affect the function. Do not use coarse scouring pads or strong cleaning agents to remove such discolorations.

The edges of thin trays cannot be completely enamelled. As a result, these edges can be rough. Anti-corrosion protection is guaranteed.

Cleaning the glass cover for the oven light

It is best to clean the glass cover with washing-up liquid.

Cleaning the glass panels

Removal

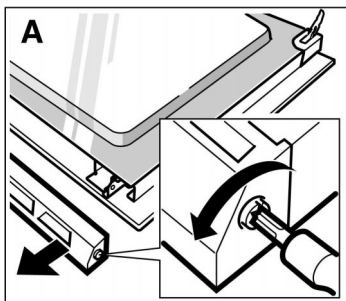

The glass panel on the oven door can be removed to assist in cleaning.

1. Remove the oven door and lay it down on a cloth with the handle facing downwards.
2. Unscrew the cover at the top of the oven door. Turn the screws clockwise or anti-clockwise to do this. (Fig. A)

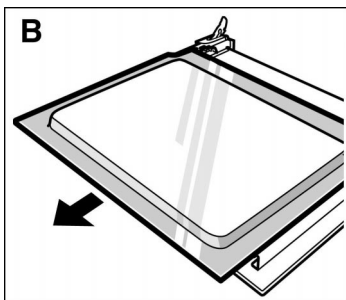

3. Raise the upper panel and remove it. (Fig. B)

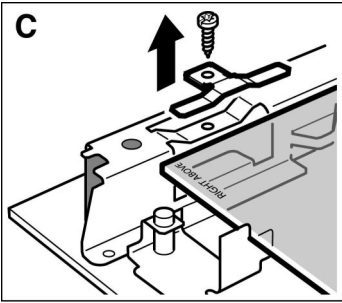

4. Unscrew the clips on the left and right and remove them. (Fig. C) Remove the panel.
5. The seal at the bottom of the panel can be removed for cleaning. To do this, unhook the seal on the left and right.

Clean the glass panels with glass cleaner and a soft cloth.

Installation

Before you insert the panel, replace the seal again at the bottom of the panel. Ensure that the label “Right above” is upside down at the bottom left of both panels.

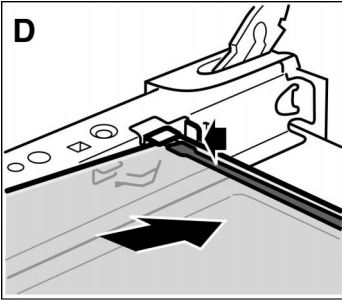

1. Slide in the glass panel backwards at an angle. (Fig. D)

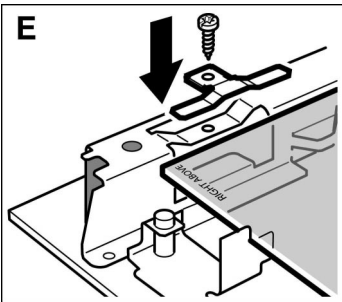

2. Fit the clips and screw them in again. (Fig. E)
3. Slide in the top panel backwards at an angle.
4. Replace the cover and screw it back on.
5. Refit the oven door.

The oven must not be used again until the panels have been correctly installed.

Seal

Clean the seal on the oven with washing-up liquid. Never use caustic or abrasive detergents.



Accessories







Immediately after use, soak the accessories in washing-up liquid. Food residues can then be easily removed with a brush or sponge.

The universal pan or the enamel baking tray can be cleaned at the same time as the oven in the automatic self-cleaning operation.

Troubleshooting

Should a malfunction occur, it is often only due to a minor fault. Please read the following notes before calling the after-sales service.

| Problem | Possible cause | Comments/remedy |
|---|--|---|
| The oven does not work. | Blown fuse. | Look in the fuse box to make sure that the fuse for the appliance is okay. |
| | Power cut | Check whether the kitchen light switches on. |
| | The oven is locked. | Touch the + and OK symbols simultaneously until the  key symbol goes out in the display. |
| The clock display flashes. | Power cut | Reset the time. |
| The oven does not heat up. | The oven door is not properly closed. | Close the oven door fully. |
| | The oven does not start heating. | Touch the OK symbol. |
| The oven does not heat up. A square appears in the temperature display. | The appliance is currently in demo mode. | Switch off the fuse in the fuse box. Wait for approximately 20 seconds. Switch on the fuse again. Within the next 2 minutes, press the rapid heating symbol for 6 seconds until the square in the display disappears. |
| The oven does not start heating. | The oven door is locked. | Wait until the  symbol in the display goes out. |

| Problem | Possible cause | Comments/remedy |
|---------------------------------------|--|---|
| The oven door cannot be opened. | The oven door is locked. | The  symbol appears in the display. You can only open the oven door again when the  locking symbol in the display goes out. |
| | Self-cleaning has started. | Wait until the  symbol goes out. |
| | The self-cleaning process was interrupted by a power failure, for example. | Wait until the oven has cooled and the  symbol goes out. |
| A “5” appears in the clock display. | The oven was operated for a long period without the setting being changed. The automatic time limiter was activated. | Switch off the  main switch. |
| “E01” or “E04” appear in the display. | The temperature sensor has failed. | Contact the after-sales service. |
| “E02” appears in the display. | Faulty mains connection. | Switch off the fuse in the fuse box and connect the cooker properly. |
| “E03” appears in the display. | The electronic circuits have overheated. | The cooling fan is operating. “E03” will clear after cooling and the cooker will heat again. |
| “E05” appears in the display. | Communication error | Switch off the fuse in the fuse box, wait approximately 20 seconds and then switch it on again. Reset the time. If this error occurs frequently, call the after-sales service. |
| “E06” appears in the display. | The lock on the oven door is defective. | Touch the  main switch. Call the after-sales service. All other oven functions can be used. |
| “E07” appears in the display. | The lock on the oven door is defective. | Contact the after-sales service. |
| “E10” appears in the display. | Data error | Switch off the fuse in the fuse box, wait approximately 20 seconds and then switch it on again. Reset the time. If this error occurs frequently, call the after-sales service. |

| Problem | Possible cause | Comments/remedy |
|-------------------------------|------------------------------------|---|
| "E11" appears in the display. | A symbol was touched for too long. | Touch all control buttons individually. If the error message remains, please contact the after-sales service. |
| "E15" appears in the display. | The oven has become too hot. | Let the oven cool and then you will be able to operate it again. If this error occurs frequently, call the after-sales service. |

Repairs may only be carried out by fully trained after-sales service technicians.

Incorrect repairs may result in serious injury to the user.

Replacing the oven light

If the oven light fails, it must be replaced. 10 watt heat-resistant halogen bulbs can be obtained from the after-sales service or from specialist shops. Hold the halogen bulb with a dry cloth. This will increase the service life of the bulb.

Only use these bulbs.

Method

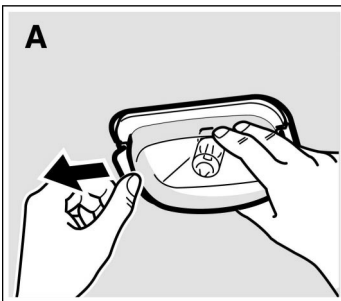

1. Switch off the oven fuse in the fuse box.
2. Place a tea towel in the cold oven to prevent damage.
3. Remove the glass cover. To do this, press the metal tab to the side with your thumb. Figure A.

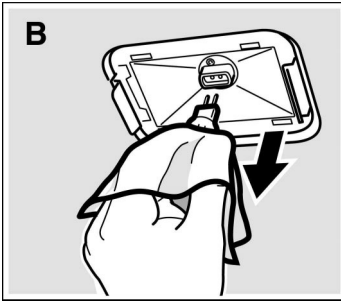

4. Pull out the bulb - do not turn it - and insert the new bulb. Figure B. Take care to position the pins correctly. Press the bulb in firmly.
5. Fit the glass cover back on. To do this, insert it on one side and press firmly on the other side. The glass cover will now click into place.
6. Remove the tea towel and switch the fuse back on.

Replacing the oven light

If the oven light fails, it must be replaced. Heat-resistant 10 watt halogen bulbs are available from your local specialist. Hold the halogen bulb with a dry cloth. This will increase the life of the bulb. Only use these bulbs.

Method

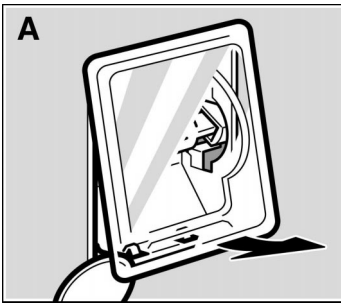

1. Switch off the fuse in the fuse box.
2. Place a tea towel in the cold oven to prevent damage.
3. Remove the glass cover. To do this, open the glass cover from underneath by hand. Fig. A. If the glass cover is difficult to remove, use a spoon to help you.

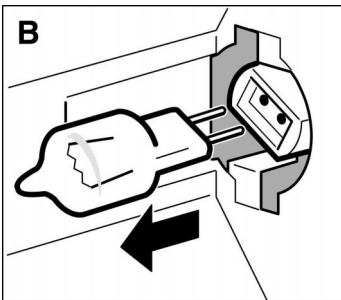

4. Remove the bulb - do not turn it - and fit the new bulb. Fig B. Take care to position the pins correctly. Push the new bulb in firmly.

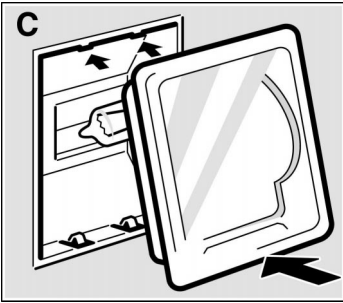

5. Put the glass cover back on. Make sure that the curvature of the glass is on the right. Insert the glass at the top and press it in firmly at the bottom. Fig C. The glass cover will now click into place.
6. Remove the tea towel and switch on the fuse again.

Replacing the glass cover

The glass cover on the oven light must be replaced if it is damaged. Replacement glass covers may be obtained from the after-sales service. To this end, please specify the E number and FD number of your appliance.

After-sales service

Our after-sales service is there for you if your oven needs repairing. You will find the address and telephone number of your nearest after-sales service centre in the phone book. The after-sales service centres listed will also be happy to advise you of a service point in your local area.

E number and FD number

Please quote the E number (product number) and the FD number (production number) of your appliance when contacting the after-sales service. The rating plate containing these numbers is found on the right, on the side of the oven door. You can make a note of these numbers in the space below to save time in the event of your appliance malfunctioning.

| | |
|-------|--------|
| E no. | FD no. |
|-------|--------|

| |
|-----------------------|
| After-sales service ☎ |
|-----------------------|

Packaging and old appliances

Disposing in an environmentally-responsible manner

Unpack the appliance and dispose of the packaging in an environmentally-responsible manner.



This appliance is labelled in accordance with the European Directive 2002/96/EC concerning used electrical and electronic appliances (waste electrical and electronic equipment – WEEE).

The guideline determines the framework for the return and recycling of used appliances as applicable.

Tables and tips

This table contains a selection of dishes and the optimum settings at which to cook them. You can find out which type of heating and temperature is best for your dish, which accessories to use, and at which oven level the dish should be inserted. You will find a variety of tips about ovenware and preparation, and a small troubleshooting section in case anything should go wrong.

Cakes and pastries

Baking on one level

If you are baking cakes on one level, you should use top/bottom heating . This will give the best results for your cakes.

Baking tins

It is best to use dark baking tins. You should use intensive heat  when using thin baking tins, or glass containers.

Place the cake tin on the wire rack.

Tables







The values in the table apply to dishes placed in a cold oven. This saves energy. Shorten the baking times indicated by 5 to 10 minutes if you have preheated the oven.

The tables show which type of heating is best for different cakes and bakes.

The temperature and cooking time you select depends on the quantity and type of pastry. This is why “ranges” are given in the tables. You should try to use a lower temperature setting to start with, since this allows more even browning. If necessary, use a higher temperature setting the next time.

More information can be found in the “Baking tips” section which follows the tables.





Intensiv heat

| Food | Dish | Shelf position | Cooking method | Temp. °C | Time, minutes |
|--------------------------------|------------------------|----------------|---|----------|---------------|
| Fruit crumble | glass dish | 2 |  | 180 | 35-45 |
| Jam tarts* | 12 hole bun tin | 2 |  | 200 | 15-20 |
| Yeast cookery* (f.ex.Pizza) | universal pan | 2 |  | 180 | 20-30 |
| Tarts** | 20 cm plate or pie tin | 2 |  | 200 | 40-50 |
| Quiches** | glass dish | 2 |  | 210 | 40-50 |
| Pies** | pie dish | 2 |  | 200 | 45-55 |

* Preheat oven





** For a crispy bottom always place dish on the universal pan

3D-Hot air

| Food | Dish | Shelf position | Cooking method | Temp. °C | Time, minutes |
|-----------------|---|----------------|---|--------------|---------------|
| Rich fruit cake | Ø 23 cm round tin or 20 cm square cake tin | 2 |  | 140 | 160-170 |
| Meringues | universal pan | 3 |  | 100 | 100-150 |
| Pavlova | universal pan | 3 |  | 150*+ 100 | 100-120 |
| Jacket Potatoes | universal pan | 2 |  | 170 | 60-70 |





* Preheat oven

Conventional heat

| Food | Dish | Shelf position | Cooking method | Temp. °C | Time, minutes |
|------------------|--------------------|----------------|---|----------|---------------|
| Light fruit cake | 20 cm tin | 2 |  | 180 | 70-80 |
| Swiss roll* | swiss roll tin | 2 |  | 200 | 10-12 |
| Rich biscuits | baking tray | 3 |  | 180 | 15-20 |
| Souffles | 1,2 l souffle dish | 2 |  | 180 | 40-50 |







* Preheat oven

Conventional baking

| Food | Dish | Shelf position | Cooking method | Temp. °C | Cooking time, min |
|--------------------|------------------------------|----------------|---|----------|-------------------|
| Victoria sandwich | 20 cm tins | 2 |  | 170 | 30 |
| Bread | loaf tin (900 g or 2x 450 g) | 1 |  | 240 | 25-35 |
| Scones* | baking tray | 1 |  | 220 | 15-20 |
| Yorkshire Pudding* | 12 hole bun tin | 2 |  | 200 | 25-35 |

* Preheat oven

3D-Hot air Baking on 2 or 3 levels

| Food | Dish | Shelf position | Cooking method | Temp. °C | Cooking time, min |
|-------------------|----------------|----------------|---|----------|-------------------|
| Victoria sandwich | 20 cm tins | 1+3 |  | 160 | 35-40 |
| Scones* | baking trays | 1+3 |  | 180 | 20-30 |
| Jacket potatoes | wire racks | 1+3 |  | 160 | 60-90 |
| Biscuits | baking trays** | 1+3 |  | 150 | 20-25 |
| | | 2+3+5 | | 140 | 25-30 |
| Small Cakes* | baking trays** | 1+3 |  | 150 | 35-40 |
| Meringues | baking trays** | 1+3 |  | 90 | 100-150 |
| | | 2+3+5 | | 90 | 100-150 |
| Full meal | wire racks | 1+4 |  | 180 | 80-90 |

* Preheat oven

** When baking on two levels, use the universal pan provided, as the top shelf. When baking on three levels, use the universal pan as the bottom shelf.

Baking tips

You wish to cook to your own recipe.

Refer to the instructions in the tables for similar types of food.

How to check that a sponge cake is cooked properly.

Approximately 10 minutes before the end of the baking time given in the recipe, pierce the tallest point of the cake with a cocktail stick. The cake is done if the cocktail stick comes out clean.

The cake collapses.

Next time, use less liquid or decrease the oven temperature by 10 degrees. Observe the cooking times in the recipe.

The cake has risen in the centre but is lower at the edges.

Do not grease the sides of the springform cake tin. As soon as the cake is done, carefully loosen the cake around the edges using a knife.

The cake is too dark at the top.

Insert it at a lower level in the oven, select a lower temperature and cook the cake a little while longer.

The cake is too dry.

Use a toothpick to make small holes in the finished cake. Then drizzle fruit juice or alcohol over the top. Next time you should decrease the temperature by around 10 degrees and reduce the baking times.

The bread or cake (e.g. cheesecake) looks fine, but is soggy on the inside (soft, with watery areas).

Next time you should add a little less liquid and cook for a little longer at a lower temperature. Cakes with fruit topping: Precook the base first of all. Sprinkle with almonds or breadcrumbs and then place the topping over this. Please observe the recipe and the baking times.

The pastry is unevenly browned.

Select a slightly lower temperature to ensure that the pastry is baked more evenly. Delicate pastry should be baked on one level using top/bottom heating . Baking paper that protrudes over the food can affect the air circulation. For this reason, always cut the baking paper to fit the baking tray.

The fruit cake is too light at the bottom. The fruit juice flows over.

Use the deeper universal pan next time.

You were baking on several levels. The food on the top baking tray is darker than that on the bottom baking tray.

Always use 3D hot air  when baking on several levels. Baking trays that are placed in the oven at the same time will not necessarily be ready at the same time.

Condensation is formed when baking cakes containing fresh fruit.

Baking may result in the formation of water vapour. It escapes above the door handle. The steam may settle and form water droplets on the control panel or on the fronts of adjacent units. This is a normal physical process.

Meat, poultry, fish

Ovenware

You may use any heat-resistant dishes. The universal pan is also suitable for larger roasts.

Always place the dishes in the centre of the wire grill.

Hot glass dishes should be placed on a dry kitchen towel after being removed from the oven. The glass could crack if placed on a cold or wet surface.

Advice on roasting

The roasting result depends on the type and quality of meat.

Add 2 to 3 soup spoons of liquid to lean meat, and 8 to 10 soup spoons of liquid to pot roasts, depending on the size.

Meat should be turned half way through the cooking time.

When the roast is ready, switch off the oven and leave the roast to stand for 10 minutes with the oven door closed. This allows the meat juices to distribute more favourably.

Advice on grilling

Always close the oven door when grilling.

If possible, use pieces of meat which are of the same thickness. They should be at least 2 to 3 cm thick. Such pieces will be browned evenly and stay juicy and soft in the middle. Only salt the steaks after they have been grilled.

Place the pieces of meat directly onto the wire grill. If you are grilling just one piece of meat, it will turn out best if you place it in the centre of the wire grill. You should also insert the universal pan at level 1. The meat juices are collected here and the oven is kept clean.











Turn the pieces of meat after two thirds of the cooking time indicated.

The grill element automatically switches itself off and back on again. This is normal. The number of times this happens depends on the grill setting you have selected.





Tables

The table applies to insertion into a cold oven. The time specifications are provided as guidelines only and depend on the type and quality of the meat.

Roasting

| Food | Shelf position | Cooking method | Temp. °C | Cooking time min per 1 lb. |
|--|----------------|---|----------|----------------------------|
| Beef rare | 1 |  | 220-240 | 15+15 |
| Beef medium | 1 |  | 210-230 | 15+20 |
| Beef well done | 1 |  | 200-220 | 20+25 |
| Beef fillet | 1 |  | 210-230 | 15+20 |
| Lamb medium | 1 |  | 170-190 | 25+25 |
| Lamb well done | 1 |  | 150-170 | 30+30 |
| Pork | 1 |  | 180-200 | 30+30 |
| Chicken, Duck, Goose and Turkey up to 5 kilo | 1 |  | 170-210 | 20+20 |
| Large Turkey | 1 |  | 170-190 | 13+13 |
| Chops and chicken joints | 2 |  | 190-220 | 30 |

Grilling

| Food | Shelf position | Cooking method | Grill | Cooking time min per 1 lb. |
|---------------------------|----------------|---|--------|----------------------------|
| Meat steaks, bacon | 5 |  | 2 or 3 | 12-22 |
| Sausages and Fish fingers | 4 |  | 3 | 15-20 |
| Fish | 2 |  | 2 | 10-20 |
| Toast, 4 pieces | 4 |  | 3 | 6-7 |
| Toast, 9 pieces | 4 |  | 3 | 4-5 |

Tips for roasting and grilling

The table does not contain information for the weight of the roast.

Select the next lowest weight from the instructions and extend the time.

How can you tell when the roast is ready?

Use a meat thermometer (available from specialist shops) or carry out a "spoon test". Press down on the roast with a spoon. If it feels firm, it is ready. If the spoon can be pressed in, it needs to be cooked for a little longer.

The roast is too dark and the crackling is partly burnt.

Check the shelf position and temperature.

The roast looks good, but the juices are burnt.

Next time, use a smaller roasting dish or add more liquid.

The roast looks good, but the juices are too clear and watery.

Next time, use a larger roasting dish or add less liquid.











Steam rises from the roast when the juice is basted.





Use hot air grilling instead of top/bottom heating. This prevents the bottom of the roast from becoming too hot, thereby producing less steam.

Frozen foods

Please observe the instructions on the packaging.

The values in the table apply to dishes placed in a cold oven.

| Meal | Use for | Level | Type of heating | Temperature in °C | Cooking time in minutes |
|------------------|-------------------------|-------|---|-------------------|-------------------------|
| Pizza* | Pizza with a thin base | 2 |  | 200-220 | 15-25 |
| | Pizza with a thick base | 2 |  | 180-200 | 20-30 |
| | Pizza baguette | 2 |  | 180-200 | 20-30 |
| | Mini pizza | 3 |  | 190-210 | 10-20 |
| Potato products* | Chips | 2 |  | 200-220 | 20-30 |
| | Duchess potatoes | 2 |  | 200-220 | 20-30 |
| | Fried potatoes | 2 |  | 200-220 | 20-30 |
| | Filled potato skins | 2 |  | 200-220 | 15-25 |
| Baked goods* | Rolls | 3 |  | 190-210 | 10-20 |
| | Pretzels | 3 |  | 200-220 | 10-20 |

| Meal | Use for | Level | Type of heating | Temperature in °C | Cooking time in minutes |
|--------------|-------------------|-------|---|-------------------|-------------------------|
| Fried foods* | Fish fingers | 2 |  | 200-220 | 5-15 |
| | Chicken nuggets | 2 |  | 200-220 | 10-25 |
| | Vegetable burgers | 2 |  | 200-220 | 15-30 |
| Strudel* | Apple strudel | 3 |  | 190-210 | 30-40 |

* Line the universal pan with greaseproof paper. Please ensure that the greaseproof paper is suitable for use at these temperatures.



Slow cooking

Slow cooking is the ideal cooking method for all tender pieces of meat which are to be cooked rare or very rare. The meat remains very juicy and turns out as soft as butter. Advantages: The benefit of this cooking method is that it allows lots of scope for menu planning because slow-cooked meat is easy to keep warm.

Suitable dishes

Use a shallow dish, e.g. a porcelain serving dish.

Method

1. Touch the  main switch.
2. Select top/bottom heating  using the > up arrow.
3. Touch the – symbol until 90 °C appears.
4. Preheat the oven and also warm up a serving dish on the wire rack at shelf position 2.
5. Heat a little fat in a pan to a high temperature. Sear the meat over a high heat and then place directly on the warmed plate.
6. Put the dish with the meat back into the oven and complete the cooking. For most pieces of meat a cooking completion temperature of 90 °C is ideal.
7. Touch the OK symbol to start the oven.

Notes on slow cooking

Only use perfectly fresh meat for this.

Sear the meat at a very high temperature and for a sufficient amount of time.

When completing the cooking in the oven, do not cover the meat.

The meat should not be turned even if it is a large joint.

The meat can be cut immediately after slow cooking. It is not necessary to leave the meat to stand.

This particular cooking method always leaves the inside of the meat medium rare. However, this does not mean that it is raw or not cooked properly.

Table

All tender joints of beef, pork, veal and lamb are suitable for slow cooking. The length of time for searing and completing are worked out according to the size of the piece of meat.

The times for searing refer to the meat being inserted in hot fat.

| Meal | Searing on the hotplate (time in minutes) | Completing in the oven (time in minutes) |
|-------------------------------------|--|---|
| Small pieces of meat | | |
| Cubes or strips | 1-2 all over | 20-30 |
| Small cutlets, steaks or médaillons | 1-2 per side | 35-50 |
| Medium-sized pieces of meat | | |
| Whole fillet (400 - 800 g) | 4-5 all over | 75-120 |
| Saddle of lamb (approx. 450 g) | 2-3 per side | 50-60 |
| Double cutlet | 7-9 all over | 100-120 |
| Large pieces of meat | | |
| Whole fillet (over 900 g) | 6-8 all over | 120-150 |
| Roast (600 g - 1 kg) | 8-10 all over | 120-150 |
| Roast (1.1 - 2 kg) | 8-10 all over | 180-270 |

Tips on slow cooking

Meat that has been cooked using slow cooking is not as hot as meat that has been cooked conventionally.





Warm the plates and serve the sauce at a high temperature.

If you want to keep slow-cooked meat warm.

Turn the temperature down to 70 °C after slow-cooking. Small pieces of meat can be kept warm for up to 45 minutes, and large pieces for up to two hours.

Special meals

You can set temperatures of up to 300 °C with this cooker. This makes it particularly good for cooking crispy pizzas or savoury flans. Just try it.

| | Ovenware | Level | Type of heating | Temperature in °C | Cooking time |
|---|-----------------------------|-------|---|-------------------|--------------------------------|
| Preheat | Pizza dish or universal pan | 1 |  | 300 | 7-12 Minutes |
| Pizza | universal pan | 3 |  | 300 | 7-12 Minutes |
| Savoury flans (yeast dough with thin topping) | | | | | |
| Meat in pastry (preheat to 280 - 300 °C) | Universal pan | 2 |  | 170-190 | 110-120 Minutes |
| 750 g to 1 kg of meat and the same amount of bread dough. | | | | | |
| Fish, whole, 2 kg (e.g. fresh salmon) | Rack* | 2 |  | 280-300 95 | 10 Minutes 50-60 Minutes |

Place the prepared fish on the wire grill. Preheat the oven to 280-300 °C, sear the fish for 10 minutes at this temperature, and then lower the temperature to 95 °C.



* Insert the universal pan at level 1.

Defrosting

Remove the food from its packaging and place it in a suitable dish on the wire grill.

Please observe the instructions on the packaging.

The defrosting times depend on the type and amount of food.

| Meal | Accessories | Level | Type of heating | Temperature in °C |
|--|-------------|-------|---|-------------------|
| Delicate frozen foods e.g. cream gateaux, cream cakes, cakes with chocolate or icing, fruit etc. | Wire rack | 2 |  | 20 °C |
| Other frozen foods* Chicken, sausage and meat, bread, bread rolls and other pastries | Wire rack | 2 |  | 50 °C |

* Cover frozen food with microwave foil. Place poultry onto the plate with the breast side down.





In the 30 to 60 °C range, the oven light remains switched off. This gives best control.

Drying

Only use perfectly fresh fruit and vegetables, and wash them thoroughly.

Allow the food to drain well and dry it yourself.

Line the universal pan and wire rack with baking paper or greaseproof paper.

| Meal | Level | Type of heating | Temperature in °C | Cooking time in hours |
|---------------------------|-------|---|-------------------|-----------------------|
| 600 g apple rings | 2 + 4 |  | 80 | Approx. 5 |
| 800 g sliced pears | 2 + 4 |  | 80 | Approx. 8 |
| 1.5 kg prunes or plums | 2 + 4 |  | 80 | Approx. 8 - 10 |
| 200 g fresh herbs, washed | 2 + 4 |  | 80 | Approx. 1½ |

Note

Very moist fruit or vegetables should be turned several times. Once dried, remove the food from the paper immediately.

Preserving

Preparation

The jars and rubber sealing rings must be clean and intact. Use jars of the same size if possible. The instructions in the table refer to round 1-litre jars. Caution Do not use larger or taller jars. The lid could crack.



Only use perfectly fresh fruit and vegetables. Wash them thoroughly.

Pour the fruit or vegetables into the jars. Wipe clean the tops of the jars again if necessary. They must be clean. Place a wet rubber sealing ring and lid on each jar and lock the jars using clamps.

Do not place more than six jars in the oven.

The times specified in the tables are guidelines only. They can be influenced by the room temperature, the number of jars and the amount and temperature of the jar contents. Before you change settings or switch off the appliance, make sure that the contents of the jars are actually bubbling.

Setting procedure

1. Place the universal pan on level 2. Place the jars inside the pan so that they do not come into contact with each other.
2. Pour ½ litre of hot water (approx. 80 °C) into the universal pan.
3. Close the oven door.
4. Touch the  main switch.
5. Set bottom heating  using the downward arrow .
6. Touch the + symbol until 170 - 180 °C appears in the display.
7. Start the oven by touching the OK symbol.

Preserving fruit

As soon as the contents of the jars begins to simmer, that is when small bubbles appear at short intervals - after about 40 to 50 minutes - turn off the ① main switch.

The jars should be removed from the oven after being reheated for 25 to 35 minutes. If the food is left to cool in the oven for longer, bacteria might form, accelerating spoilage of the preserved fruit.

| Fruit in 1-litre jars | After bubbling | Reheating |
|---|-----------------------|--------------------|
| Apples, red/blackcurrants, strawberries | Turn off | Approx. 25 minutes |
| Cherries, apricots, peaches, gooseberries | Turn off | Approx. 30 minutes |
| Apple purée, pears, plums | Turn off | Approx. 35 minutes |

Preserving vegetables

As soon as the contents of the jars begin to simmer, set the temperature back to approximately 120 to 140 °C. Start by touching the ok symbol again. The table shows when you can switch off the oven: Allow the vegetables to stand in the oven for a further 30-35 minutes.

| Vegetables with cold stock in 1-litre jars | After bubbling 120-140 °C | Reheating |
|---|--------------------------------------|--------------------|
| Cucumbers | - | Approx. 35 minutes |
| Beetroot | Approx. 35 minutes | Approx. 30 minutes |
| Brussel sprouts | Approx. 45 minutes | Approx. 30 minutes |
| Beans, kohlrabi, red cabbage | Approx. 60 minutes | Approx. 30 minutes |
| Peas | Approx. 70 minutes | Approx. 30 minutes |

Remove the jars

Never place the hot jars on a cold or wet surface as this could cause the glass to crack.

Energy saving tips

Only preheat the oven if it specifies in the recipe or in the table in the instruction manual that you should do so.

Use non-stick, black painted or enamelled tins. They absorb the heat especially well.

If you have several cakes to bake it is best to bake them one after the other. The oven is still warm. This shortens the baking time for the second cake. You can also put two baking tins in one after the other.

For long cooking times, the oven can be switched off 10 minutes before the end of the cooking time and the remaining heat can be used to finish the cooking.

Acrylamide in food

Experts are currently discussing how dangerous acrylamide in food can be. We have compiled this information sheet for you on the basis of current research.

Where does acrylamide come from?

Acrylamide in food does not come from external contamination. It is formed in the food itself during preparation - provided that the food contains carbohydrate and protein. Exactly how this happens has not yet been completely explained. However, it appears that the acrylamide content is strongly influenced by:

- high temperatures
- a low water content in food
- intensive browning of the food.

What sort of foods are affected?

Acrylamide forms mostly in grain and potato products that are prepared at high temperatures, e.g.:

crisps, chips,
toast, rolls, bread,
baked goods made from shortcrust pastry (speciality
biscuits and cakes).

What can you do?

You can avoid high levels of acrylamide when baking, frying and grilling.

The following recommendations were published by AID¹ and BMVEL² to help you minimise acrylamide levels:

In general

Keep cooking times as short as possible.

“Brown rather than burn” - cook food only until it is golden brown.

The larger and thicker the food is, the less acrylamide it contains.

Baking

Set the temperature to a maximum of 200 °C when using the top/bottom heating setting, and to a maximum of 180 °C for the 3D hot air setting.

Cookies: Set the temperature to a maximum of 190 °C when using the top/bottom heating setting, and to a maximum of 170 °C for the 3D hot air setting. The presence of egg or egg yolk in a recipe reduces the formation of acrylamide.

Spread oven chips evenly over the baking sheet in one layer where possible. To prevent the food from drying out quickly, place at least 400 g on each baking sheet.







¹ AID “Acrylamide” information leaflet, published by AID (German Evaluation and Information Service for Nutrition, Agriculture and Forestry) and BMVEL (German Federal Ministry for Consumer Protection, Food and Agriculture), as at 12/02, Internet: <http://www.aid.de>.

² BMVEL press release 365, as at 4.12.2002, Internet:<http://www.verbraucherministerium.de>

Test dishes



referring to EN 60350.

Baking

| Food | Dish and notes | Shelf position | Cooking method | Temp. °C | Cooking time min |
|-------------------------------|---|---------------------------------------|---|----------|------------------|
| Small Cakes | baking tray | 3 |  | 170-190 | 20-30 |
| Small Cakes (preheat oven) | baking tray + universal pan* | 1+3 |  | 140-160 | 30-40 |
| | baking trays + universal pan* | 2+3+5 |  | 140-160 | 40-50 |
| Fatless sponge cake | baking tin (dark coated) | 2 |  | 160-180 | 30-40 |
| Apple pie | 2 wire racks + 2 tinplate springform cake tins Ø 20 cm | 2+4 placed diagonally |  | 180-200 | 70-80 |
| | universal pan + 2 tinplate springform cake tins Ø 20 cm | 1 in the centre alongside one another |  | 190-210 | 70-80 |

* When baking on two levels, use the universal pan provided, at shelf position three. When baking on three levels, use the universal pan as the bottom shelf.

Grilling

| Food | Dish and notes | Shelf position | Cooking method | Grill setting | Cooking time min |
|-----------------------------------|----------------|----------------|---|---------------|------------------|
| White bread (preheat oven 10 min) | wire rack | 5 |  | Setting 3 | 30 sec-2 mins |
| Beefburger* | wire rack | 4 |  | Setting 3 | 25-30 |

* Turn the burgers over after 12-15 min. Insert the universal pan at level 1.

