





# SELF-REPAIR HINTS

[en]	.....	2
[fr]	.....	18

# Self-repair hints - Bagged vacuum cleaner

 <b>Concerning this document</b> .....	<b>3</b>
1.1 Important information .....	3
1.1.1 Purpose.....	3
1.2 Explanation of symbols .....	3
1.2.1 Danger levels.....	3
1.2.2 Hazard symbols .....	3
1.2.3 Structure of the warnings.....	4
1.2.4 General symbols.....	4
 <b>Safety</b> .....	<b>5</b>
2.1 General Safety instructions .....	5
2.1.1 All domestic appliances .....	5
 <b>Diagrams</b> .....	<b>6</b>
3.1 Connection diagram.....	6
 <b>Tools and aids</b> .....	<b>7</b>
 <b>Repair</b> .....	<b>8</b>
5.1 Removing cable rewriter.....	8
5.2 Removing blower motor .....	12
5.3 Removing on / off switch .....	15

# **i** Concerning this document

## 1.1 Important information

### 1.1.1 Purpose

These repair hints support the consumer in self-repair. They contain information on how to exchange defined spare parts including warnings, risks and safety measures that need to be followed when carrying out the self-repair.

The proper function and the safety of the appliance can be affected by an improper repair and even serious threats to life or physical condition may arise. We are not liable for damages caused by or occurring during a self-repair insofar as this damage is related to the user's carelessness or failure to follow the self-repair instructions.

For repairs on domestic appliances the approved technical regulations are applied. Any existing additional country-specific requirements and regulations must be observed. In case of doubt please contact our customer service.

## 1.2 Explanation of symbols

### 1.2.1 Danger levels

The warning levels consist of a symbol and a signal word. The signal word indicates the severity of the danger.









Warning level	Meaning
 <b>Danger</b>	Non-observance of the warning message will result in death or serious injuries.
 <b>Warning</b>	Non-observance of the warning message could result in death or serious injuries.
 <b>Caution</b>	Non-observance of the warning message could result in minor injuries.
<b>Notice</b>	Non-observance of the warning message could result in damage to property.

Table 1: Danger levels

### 1.2.2 Hazard symbols

Hazard symbols are symbolic representations which give an indication of the kind of danger.

The following hazard symbols are used in this document:

Hazard symbol	Meaning
	General warning message
	Danger from electrical voltage
	Risk of explosion
	Danger of cuts
	Danger of crushing

## **i** Concerning this document



Hazard symbol	Meaning
	Danger from hot surfaces
	Danger from strong magnetic field
	Danger from non-ionizing radiation

Table 2: Hazard symbols

### 1.2.3 Structure of the warnings

Warnings in this document have a standardised appearance and a standardised structure.



	<div style="background-color: red; color: white; padding: 2px; text-align: center;"> <b>Danger</b></div> <p><b>Type and source of danger!</b> Possible consequences of ignoring the danger / warning.</p> <ul style="list-style-type: none"> <li>▶ Measures and prohibitions for preventing the danger.</li> </ul>
--	---

The following example shows a warning that warns against electric shock due to live parts. The measure for avoiding the danger is mentioned.

	<div style="background-color: red; color: white; padding: 2px; text-align: center;"> <b>Danger</b></div> <p><b>Risk of electric shock due to live parts!</b> Death by electrocution</p> <ul style="list-style-type: none"> <li>▶ Disconnect appliances from electrical supply at least 60 seconds before starting repairs.</li> </ul>
---	---

### 1.2.4 General symbols

The following general symbols are used in this document:

Gen. symbol	Meaning
	Identification of a special tip (text and/or graphic)
	Identification of a simple tip (only text)
	Identification of a link to a video tutorial





Gen. symbol	Meaning
	Identification of required tools
	Identification of required preconditions
	Identification of a condition (if ..., then ...)
	Identification of a result
[Start]	Identification of a key or button
[00123456]	Identification of a material number
Status	Identification of displayed text / window (in the appliance's display)

Table 3: General symbols

## 2.1 General Safety instructions

### 2.1.1 All domestic appliances

#### **Risk of electric shock due to live parts!**

- Errors by repairs involving electrical components can lead to electrical shock!
- Disconnect the appliance from the mains for at least 60 seconds before starting work.
- After the repair have a safety test according VDE 0701 or country-specific regulations performed.

#### **Risk of injury from sharp edges!**

- Wear protective gloves.

#### **Risk of crushing during repair, maintenance, troubleshooting and service due to heavy and moving components**

- Wear protective shoes.
- Secure heavy components from falling down.
- Do not stick body parts into moving components.

#### **Risk to the appliance's safety / function!**

- Only use original spare parts.

#### **Risk of damage to electrostatically sensitive components (ESDs)!**

- Do not touch the modules, including connections and conductor paths.

## 3.1 Connection diagram

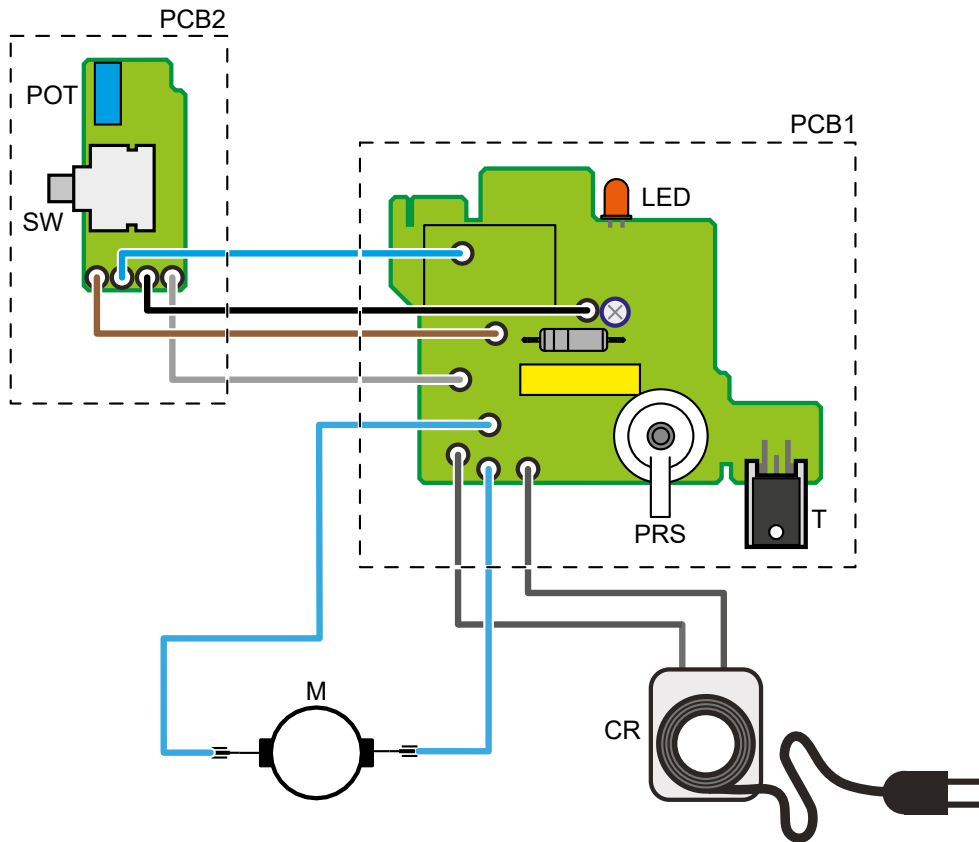

Fig. 1: Connection diagram

- PCB1 Control module
- PCB2 On / Off switch module
- SW On / Off switch
- T Triac
- POT Rotary potentiometer
- LED Bag change indicator
- PRS Pressure switch
- M Blower motor
- CR Cable rewinder

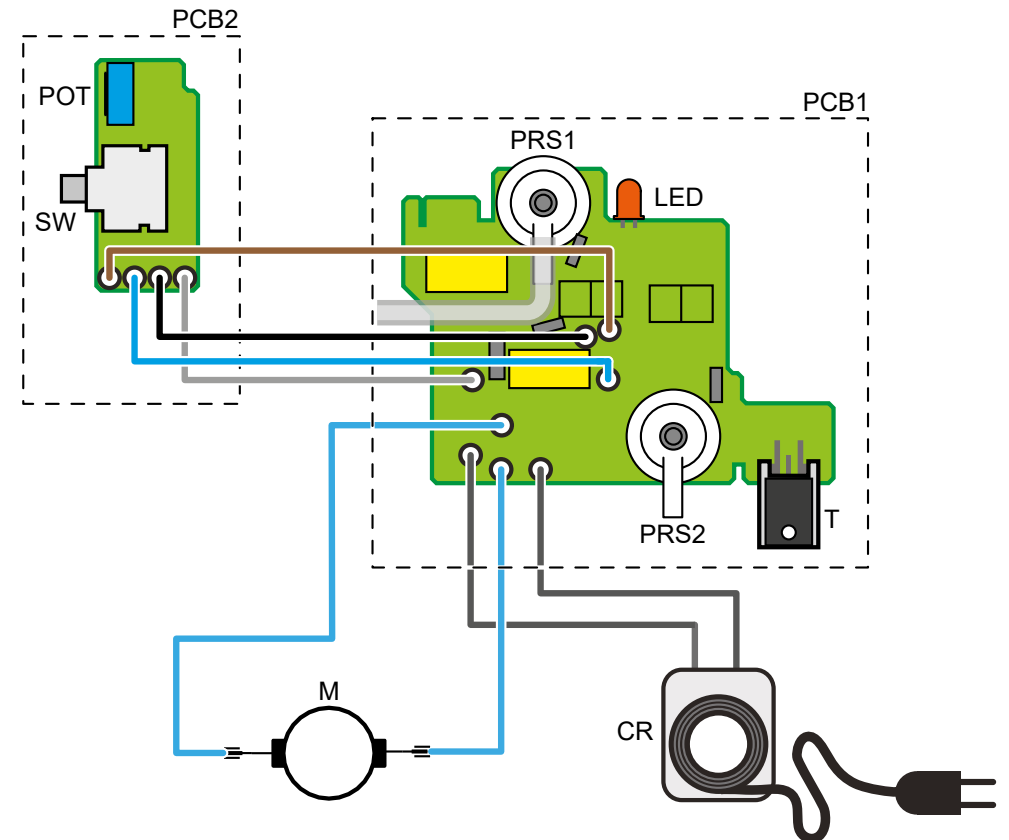



Fig. 2: Connection diagram / for variants with Automatic Power Control

- PCB1 Control module
- PCB2 On / Off switch module
- SW On / Off switch
- T Triac
- POT Rotary potentiometer
- LED Bag change indicator
- PRS1 Pressure switch 1
- PRS2 Pressure switch 2
- M Blower motor
- CR Cable rewinder

## Tools and aids

Designation	Details	Images
Torx-Bit TX15 [00341356]	6,3°mm (1/4")	
Soldering iron [00341297]	Adjustable, 60 W, 230 V AC, min. temperature 200 °C, max. temperature 450 °C, soldering tip type: pencil shape	

## 5.1 Removing cable rewinder

### Required tools:

 Screwdriver

TX15, for hexalobular recess heads,  
Reference ISO 10664



### Danger

#### Risk of electric shock due to live parts!

Death by electrocution

- ▶ Disconnect appliances from electrical supply at least 60 seconds before starting repairs.



### Caution

#### Sharp edges!

Cut injuries

- ▶ Wear protective gloves.



### Notice

#### Electrostatic-sensitive devices!

Fault or breakdown of components by electrostatic charges

- ▶ Before touching and measuring ESDs, use an electrostatic protection system (wristband with earth safe plug).
- ▶ Avoid allowing ESDs to come into contact with plastic materials that are capable of carrying a charge (films, etc.).
- ▶ Hold assemblies, modules and circuit boards in such a way that there is as little contact as possible with conductor strips or connectors.
- ▶ Do not place ESDs too close to monitors or televisions.
- ▶ Use only conductive materials or the original packaging for transportation.

1. Disconnect appliance from power supply.

2. 1. Open filter compartment lid (1).
2. Remove exhaust filter (2).

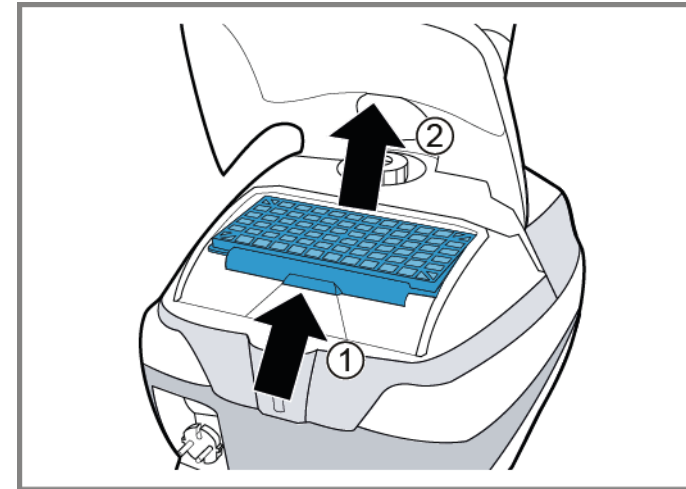

3. Remove sealing.



4. Remove three screws.

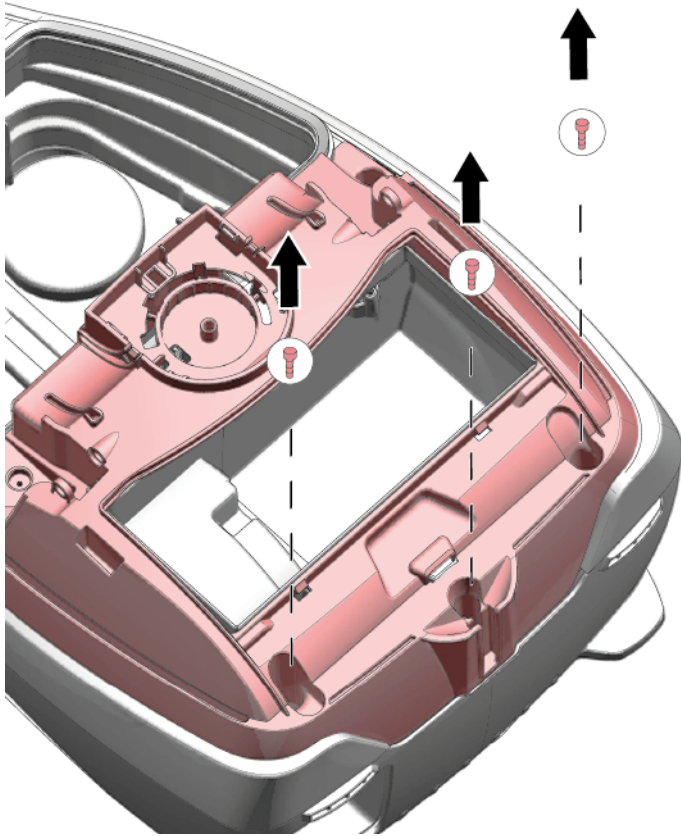

5. Close filter compartment lid.

6. Open the lid.

7. Remove four screws.

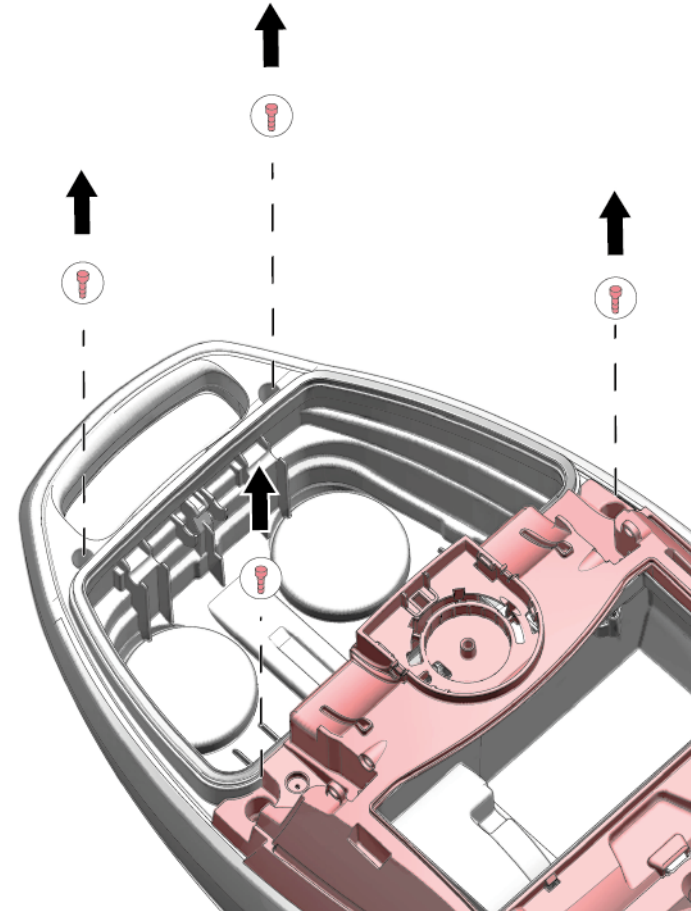

8. Remove upper housing.

9. Remove control module with on / off switch module.

10. Remove support part with sound insulation.

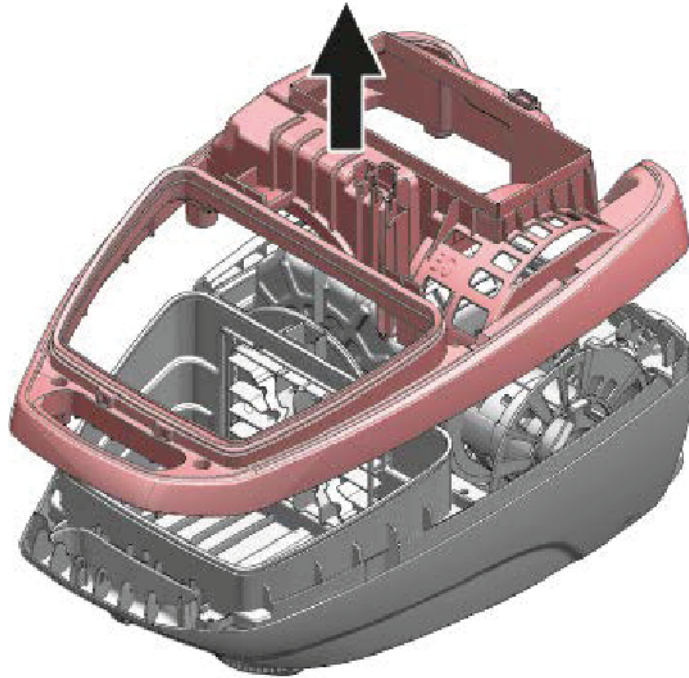

11. Remove cable shaft cover.

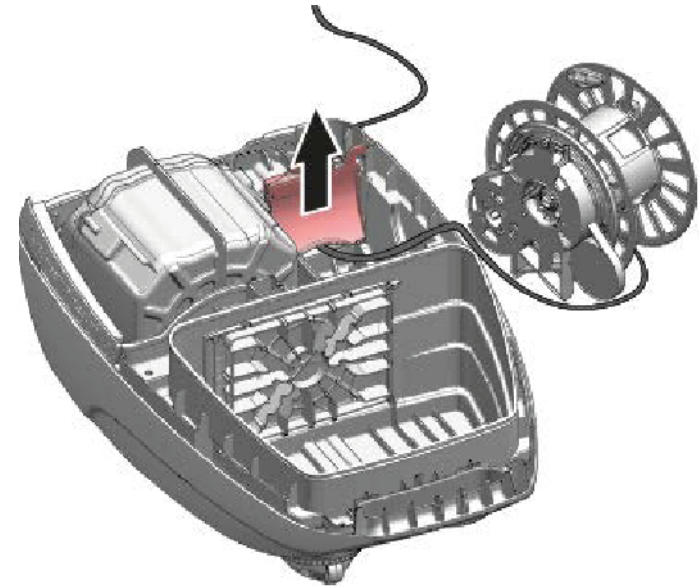

12. 1. Lift up cable rewriter (1).  
2. Disconnect electrical connection (2).

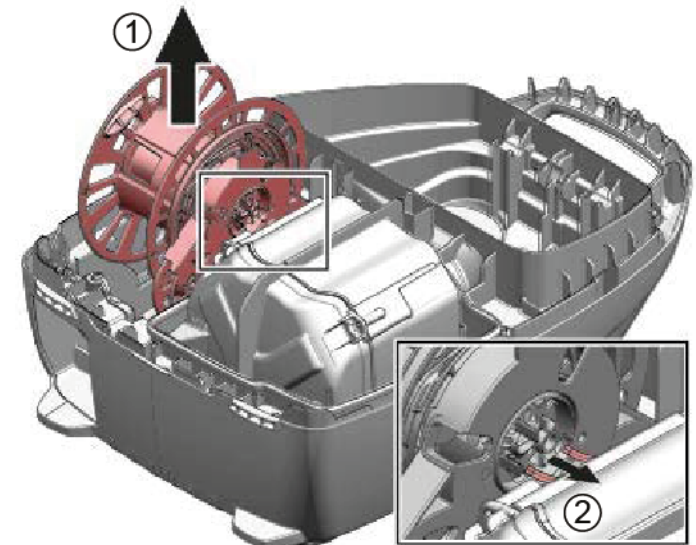

## Repair

➔ Cable rewinder is removed.

## 5.2 Removing blower motor

### Required tools:

 Screwdriver

TX15, for hexalobular recess heads,  
Reference ISO 10664



### Danger

#### Risk of electric shock due to live parts!

Death by electrocution

- ▶ Disconnect appliances from electrical supply at least 60 seconds before starting repairs.



### Caution

#### Sharp edges!

Cut injuries

- ▶ Wear protective gloves.



### Notice

#### Electrostatic-sensitive devices!

Fault or breakdown of components by electrostatic charges

- ▶ Before touching and measuring ESDs, use an electrostatic protection system (wristband with earth safe plug).
- ▶ Avoid allowing ESDs to come into contact with plastic materials that are capable of carrying a charge (films, etc.).
- ▶ Hold assemblies, modules and circuit boards in such a way that there is as little contact as possible with conductor strips or connectors.
- ▶ Do not place ESDs too close to monitors or televisions.
- ▶ Use only conductive materials or the original packaging for transportation.

1. Disconnect appliance from power supply.

2. 1. Open filter compartment lid (1).
2. Remove exhaust filter (2).

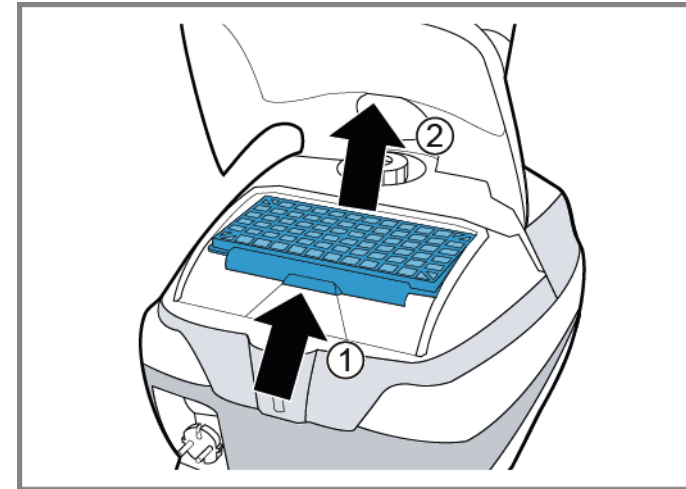

3. Remove sealing.

4. Remove three screws.

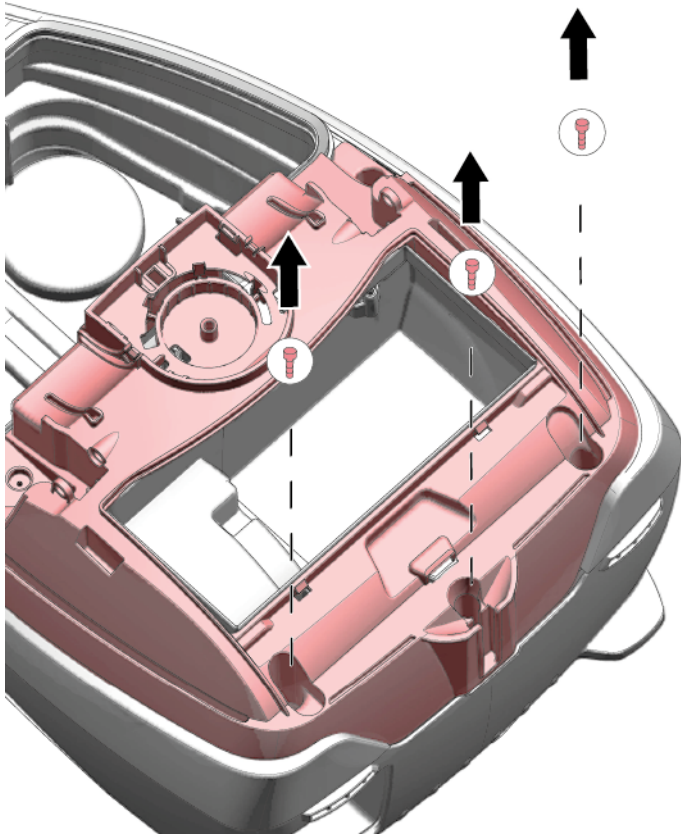

5. Close filter compartment lid.

6. Open the lid.

7. Remove four screws.

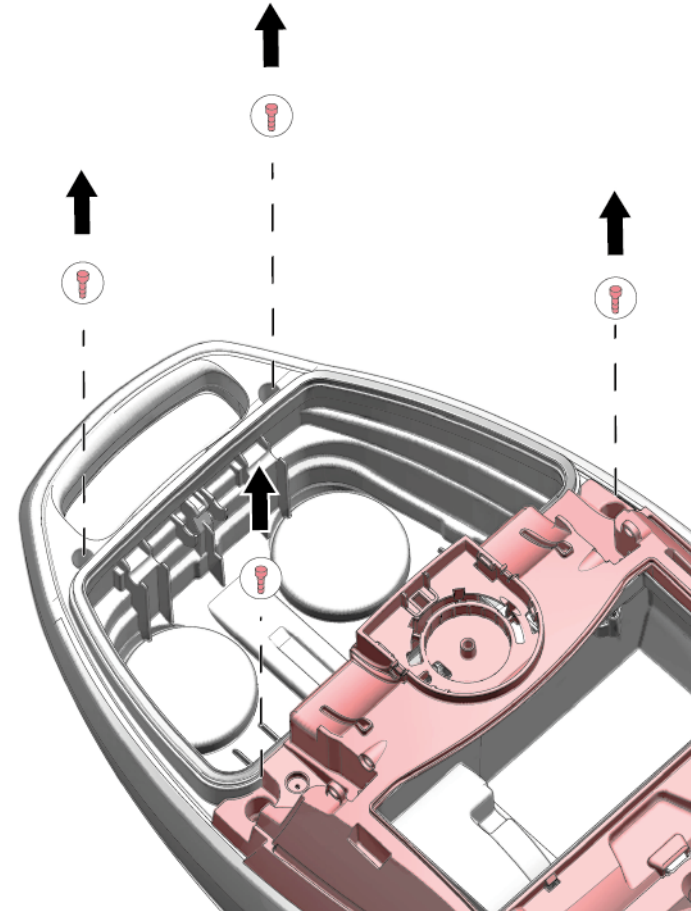

8. Remove upper housing.

9. Remove control module with on / off switch module.

## Repair

10. Remove support part with sound insulation.

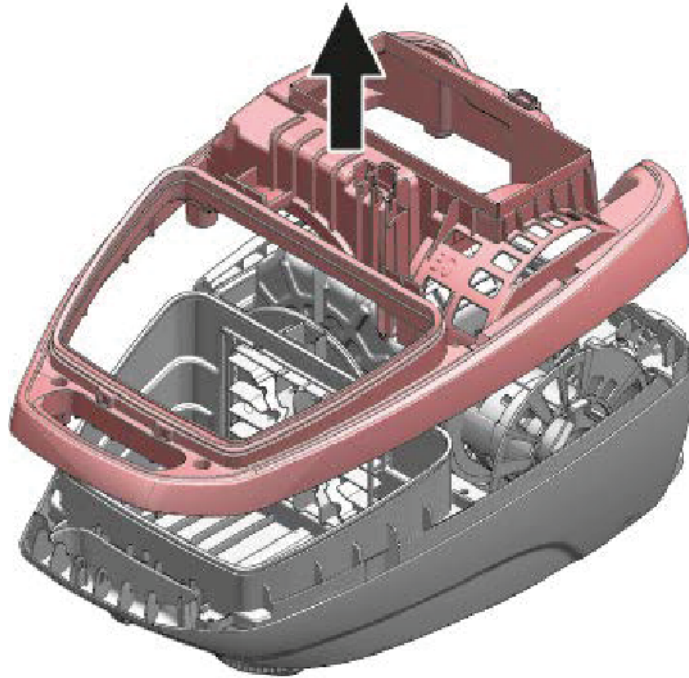

11. Remove motor housing.

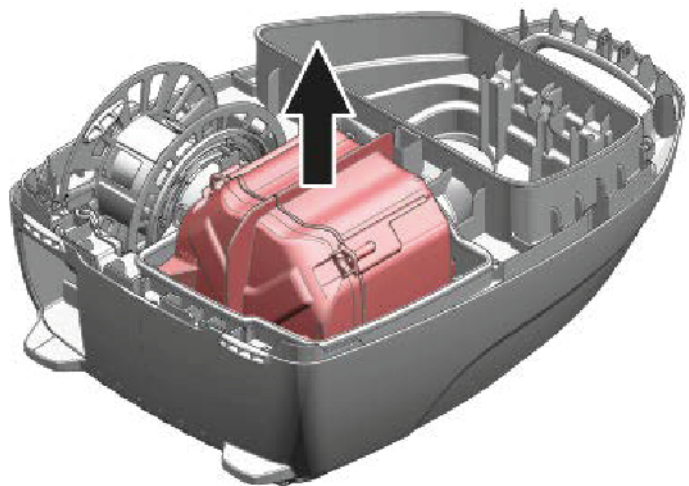



12. Remove sound insulation.

13. 1. Remove blower motor.
2. Disconnect connection cable and remove buffer.

➡ Blower motor is removed.

## 5.3 Removing on / off switch

### Required tools:

-  Screwdriver TX15, for hexalobular recess heads, Reference ISO 10664
-  Soldering iron Adjustable, 60 W, 230 V AC, min. temperature 200 °C, max. temperature 450 °C, soldering tip type: pencil shape [00341297]



### Danger

#### Risk of electric shock due to live parts!

Death by electrocution

- ▶ Disconnect appliances from electrical supply at least 60 seconds before starting repairs.



### Caution

#### Sharp edges!

Cut injuries

- ▶ Wear protective gloves.



### Notice

#### Electrostatic-sensitive devices!

Fault or breakdown of components by electrostatic charges

- ▶ Before touching and measuring ESDs, use an electrostatic protection system (wristband with earth safe plug).
- ▶ Avoid allowing ESDs to come into contact with plastic materials that are capable of carrying a charge (films, etc.).
- ▶ Hold assemblies, modules and circuit boards in such a way that there is as little contact as possible with conductor strips or connectors.
- ▶ Do not place ESDs too close to monitors or televisions.
- ▶ Use only conductive materials or the original packaging for transportation.

1. Disconnect appliance from power supply.

2. 1. Open filter compartment lid (1).
2. Remove exhaust filter (2).

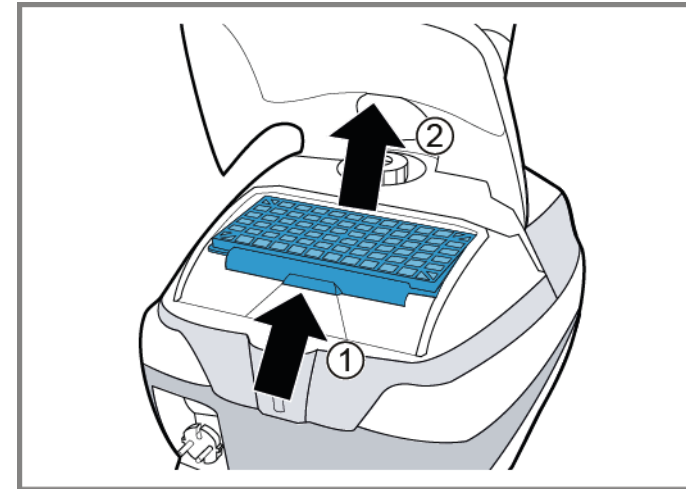

3. Remove sealing.

4. Remove three screws.

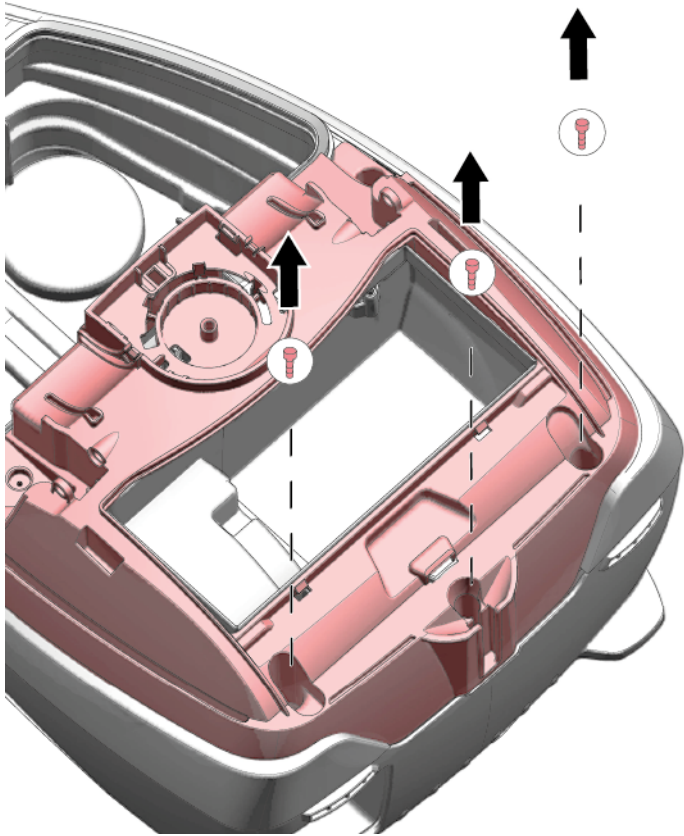

5. Close filter compartment lid.

6. Open the lid.

7. Remove four screws

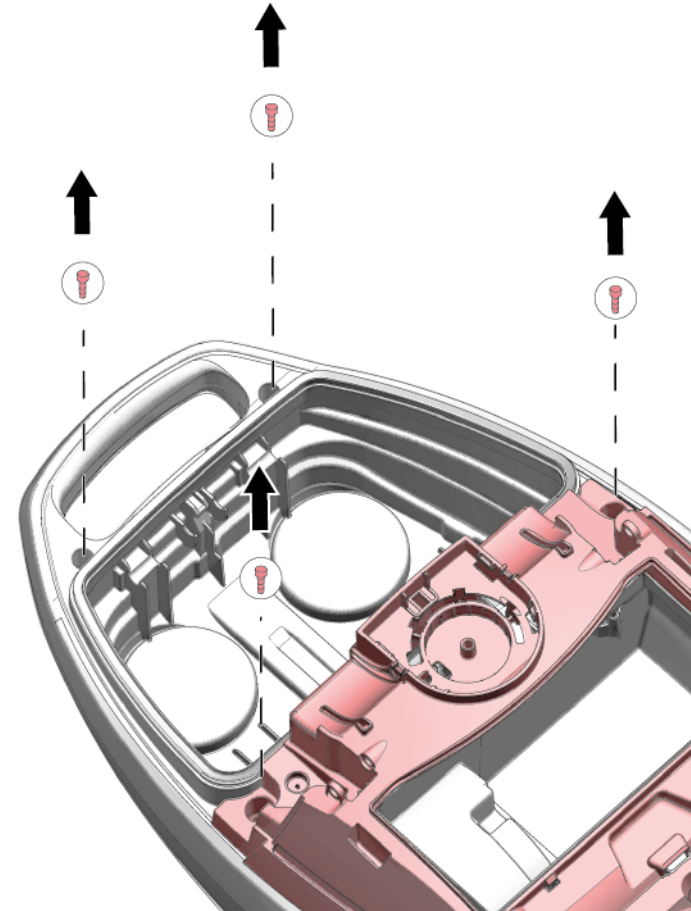

8. Remove upper housing.

9. Remove control module with on / off switch module.



10.

 **Caution**

**Risk of scalding!**





Soldering iron tip become hot during operation and may cause burns or scalding.

- ▶ Take special attention not to touch the tip during soldering / desoldering process.

Desolder on / off switch from electronic unit.

-  On / off switch is removed.

# Conseils de réparation - Aspirateur avec sac

 <b>A propos de ce document</b> .....	<b>19</b>
1.1 Informations importantes.....	19
1.1.1 Objectif.....	19
1.2 Explication des symboles.....	19
1.2.1 Niveaux de risque.....	19
1.2.2 Symboles de danger.....	19
1.2.3 Structure des indications d'avertissement.....	20
1.2.4 Symboles généraux.....	20
 <b>Sécurité</b> .....	<b>21</b>
2.1 Consignes de sécurité générales.....	21
2.1.1 Tous les appareils électroménagers.....	21
 <b>Schémas</b> .....	<b>22</b>
3.1 Schéma de branchement.....	22
 <b>Outils et aides</b> .....	<b>23</b>
 <b>Réparation</b> .....	<b>24</b>
5.1 Retirer l'enrouleur de câble.....	24
5.2 Retirer le moteur du ventilateur.....	28
5.3 Retirer l'interrupteur marche/arrêt.....	31

# **i** A propos de ce document

## 1.1 Informations importantes

### 1.1.1 Objectif

Ces conseils de réparation aident le consommateur à résoudre les problèmes par lui-même. Ils contiennent des informations sur la manière d'échanger certaines pièces détachées, ainsi que des avertissements, les risques et les mesures de sécurité à respecter lors de l'auto-réparation.

Toute réparation non conforme peut entraver le bon fonctionnement et la sécurité de l'appareil et entraîner des risques et dangers pour l'utilisateur. Nous ne sommes pas responsables des dommages causés par ou survenant lors de l'auto-réparation, dans la mesure où ces dommages sont liés à la négligence de l'utilisateur ou au non-respect des instructions d'auto-réparation.

Lors de toute réparation sur du matériel électroménager, il convient de se conformer aux réglementations techniques habituelles. Il convient de respecter les exigences et prescriptions nationales. En cas de doute, il faut contacter notre service après-vente.

## 1.2 Explication des symboles

### 1.2.1 Niveaux de risque

Les niveaux de risque se composent d'un symbole et d'un terme d'avertissement. Le mot d'avertissement caractérise la gravité du danger.







Niveau de dangerosité	Signification
 <b>DANGER</b>	Le non respect de la consigne d'avertissement provoque la mort ou des blessures graves.
 <b>AVERTISSEMENT</b>	Le non respect de la consigne d'avertissement peut provoquer la mort ou des blessures graves.
 <b>PRUDENCE</b>	Le non respect de la consigne d'avertissement peut provoquer des blessures légères.
<b>ATTENTION !</b>	Le non respect de la consigne d'avertissement peut provoquer des dégâts matériels.

Tableau 1: Niveaux de risque

### 1.2.2 Symboles de danger

Les symboles de danger sont des représentations figuratives renseignant sur la nature du danger.

Ce document utilise les symboles de danger suivants:

Symbole de danger	Signification
	Consigne d'avertissement générale
	Danger engendré par la tension électrique
	Risque d'explosion
	Risque de blessures par coupure

## **i** A propos de ce document





Symbole de danger	Signification
	Risque de blessures par écrasement
	Danger engendré par des surfaces très chaudes
	Danger engendré par un champ magnétique puissant
	Danger engendré par un rayonnement non ionisant

Tableau 2: Symboles de danger

### 1.2.3 Structure des indications d'avertissement

Les consignes d'avertissement figurant dans ce document ont un aspect uniforme et une structure uniforme.

	<p><b>⚠ DANGER</b></p> <p><b>Type et source du danger !</b>            Conséquences possibles en cas de non-respect du danger / de l'avertissement.</p> <ul style="list-style-type: none"> <li>▶ Mesures et interdictions pour éviter le danger.</li> </ul>
--	---

L'exemple suivant montre une consigne d'avertissement mettant en garde contre le risque d'électrocution. La mesure permettant d'éviter le danger est nommée.

	<p><b>⚠ DANGER</b></p> <p><b>Risque d'électrocution par des pièces conductrices de tension !</b>            Mort par électrocution.</p> <ul style="list-style-type: none"> <li>▶ Débrancher l'appareil du secteur minimum 60 secondes avant de démarrer la réparation.</li> </ul>
--	---

### 1.2.4 Symboles généraux

Ce document utilise les symboles généraux suivants:







Symbole général	Signification
	Caractérisation d'une astuce particulière (texte et/ou graphique)
	Caractérisation d'une astuce simple (texte seul)
	Caractérisation d'un lien vers une vidéo
	Caractérisation d'outils nécessaires
	Caractérisation de conditions nécessaires
	Caractérisation d'une condition (si... , alors ...)
	Caractérisation d'un résultat
[Start]	Caractérisation d'une touche ou surface de commande
[00123456]	Caractérisation d'une référence de pièce
Statut	Caractérisation d'un texte affiché / fenêtre (sur l'afficheur)

Tableau 3: Symboles généraux

## 2.1 Consignes de sécurité générales

### 2.1.1 Tous les appareils électroménagers

#### **Risque d'électrocution en raison de pièces sous tension!**

- Des erreurs lors de réparations impliquant des composants électriques peuvent entraîner une décharge électrique!
- Débrancher l'appareil du secteur minimum 60 secondes avant de démarrer la réparation.
- Après la réparation, effectuer un test de sécurité selon VDE 0701 ou les réglementations spécifiques nationales.

#### **Risque de blessures par coupure sur des bords tranchants!**

- Porter des gants de protection.

#### **Risque de casse durant la réparation, maintenance, dépannage et SAV en raison de composants lourds et mobiles**

- Porter des chaussures de protection.
- Sécuriser les composants lourds contre le risque de chute.
- Ne pas coller les pièces du châssis sur les composants mobiles.

#### **Risque lié à la sécurité / fonction de l'appareil!**

- Utiliser uniquement des pièces détachées d'origine.

#### **Risque d'endommagement des composants sensibles aux décharges électrostatiques!**

- Ne pas toucher les modules, ni leur connexions et pistes conductrices.

## 3.1 Schéma de branchement

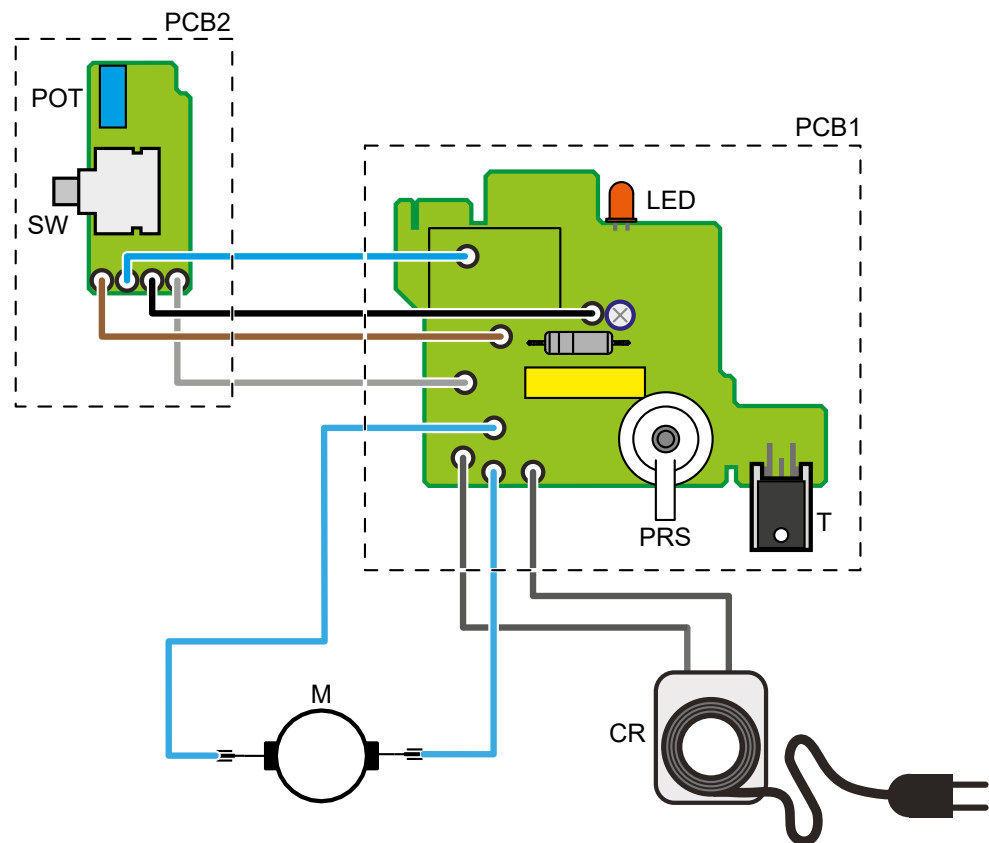

Fig. 1: Schéma de branchement

- PCB1 Module de contrôle
- PCB2 Module interrupteur M/A
- SW Interrupteur M/A
- T Triac
- POT Potentiomètre rotatif
- LED Indicateur de changement de sac
- PRS Pressostat
- M Moteur ventilateur
- CR Enrouleur de câble

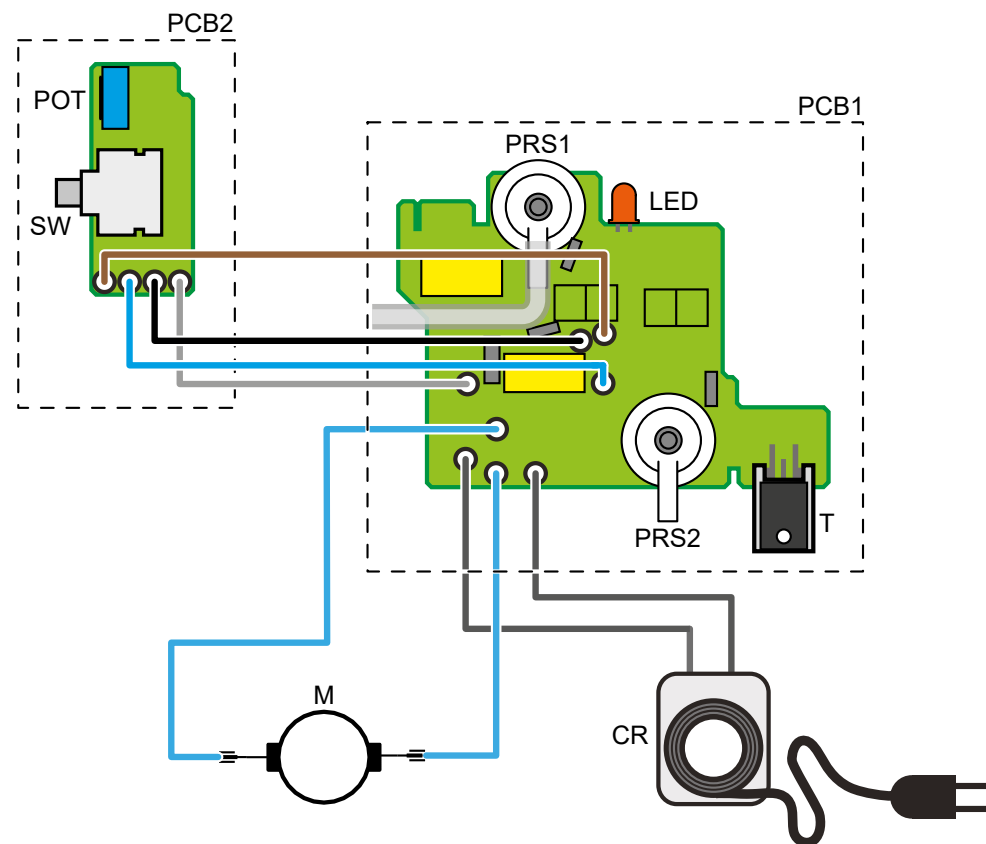



Fig. 2: Schéma de branchement / pour variantes avec Automatic Power Control

- PCB1 Module de contrôle
- PCB2 Module interrupteur M/A
- SW Interrupteur M/A
- T Triac
- POT Potentiomètre rotatif
- LED Indicateur de changement de sac
- PRS1 Pressostat 1
- PRS2 Pressostat 2
- M Moteur ventilateur
- CR Enrouleur de câble

## Outils et aides

Désignation	Détails	Images
Embout Torx TX15 [00341356]	6,3°mm (1/4")	
Fer à souder [00341297]	Ajustable, 60 W, 230 V AC, température min. 200 °C, tem- pérature max. 450 °C, type de pointe de soudage : en crayon	

## 5.1 Retirer l'enrouleur de câble

### Outillage nécessaire:

- 🔩 Tournevis TX15, pour têtes fendues hexalobulaires, Référence ISO 10664



### ⚠️ DANGER

#### Risque d'électrocution par des pièces conductrices de tension !

Mort par électrocution.

- ▶ Débrancher l'appareil du secteur minimum 60 secondes avant de démarrer la réparation.



### ⚠️ PRUDENCE

#### Arêtes vives !

Blessures par coupure

- ▶ Porter des gants de protection.



### ⚠️ ATTENTION !

#### Composants sensibles aux décharges électrostatiques !

Défaut ou panne de composants en raison de charges électrostatiques.

- ▶ Avant tout contact et mesure de ces composants, utiliser un système de protection électrostatique (ex. bracelet de mise à la terre).
- ▶ Empêcher tout contact entre ces composants et les matériaux plastiques capables de supporter une charge (films, etc.).
- ▶ Maintenir les groupes de composants, modules et platines de sorte qu'il y ait le moins de contact possible avec les bandes conductrices ou connecteurs.
- ▶ Ne pas placer ces composants trop proches de moniteurs ou télévisions.
- ▶ Utiliser pour le transport uniquement des matériaux conducteurs ou l'emballage d'origine.

1. Débrancher l'appareil du secteur.

2. 1. Ouvrir le cache du compartiment filtrant (1).
2. Retirer le filtre d'évacuation (2).

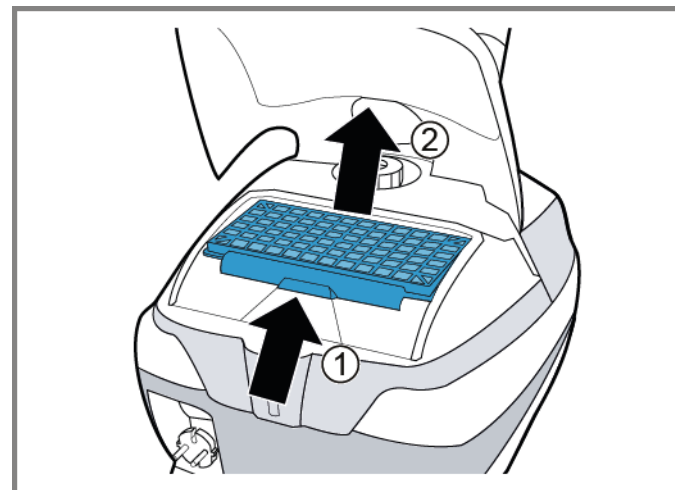

3. Retirer le joint.



## Réparation

4. Retirer trois vis.

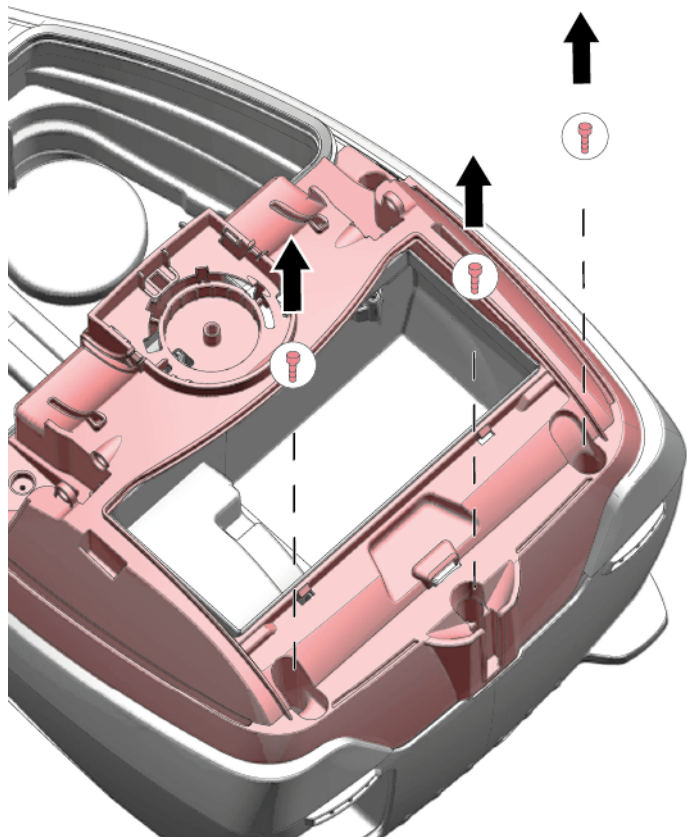

5. Fermer le cache du compartiment filtrant.

6. Ouvrir le cache.

7. Retirer quatre vis.

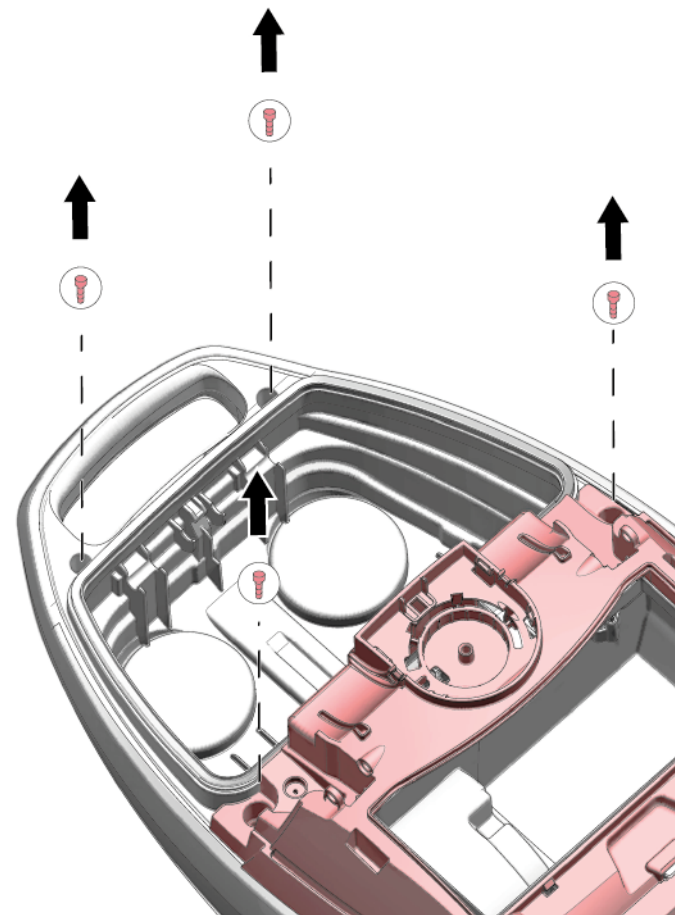

8. Retirer le boîtier supérieur.

9. Retirer le module de contrôle avec le module de l'interrupteur marche/arrêt.

## Réparation

10. Retirer la pièce de support avec l'isolation acoustique.

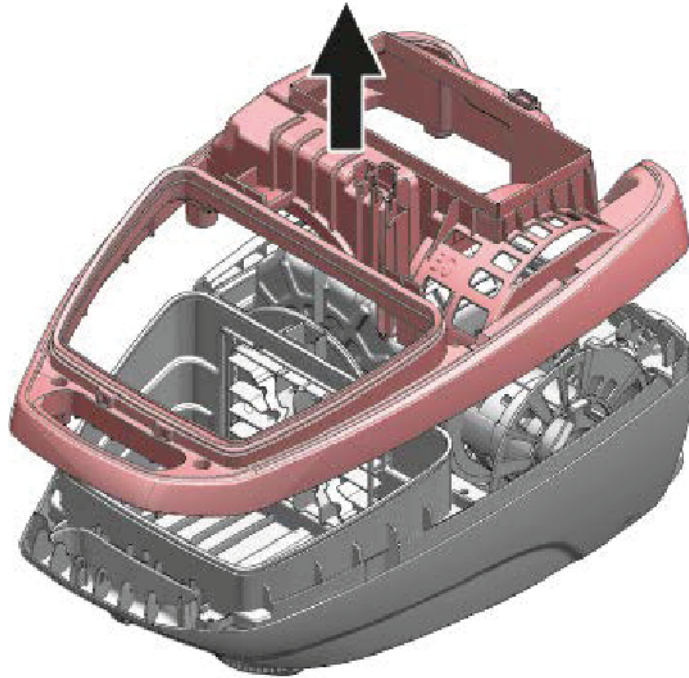

11. Retirer le cache de l'axe du câble.

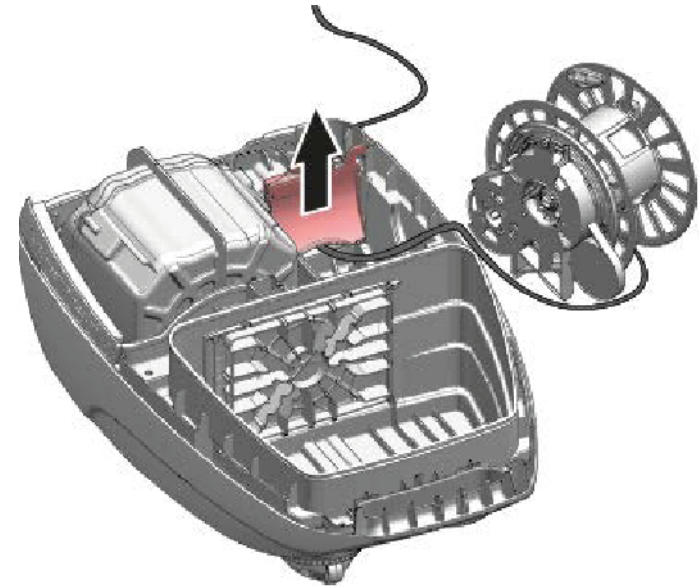

1. Soulever l'enrouleur de câble (1).
2. Débrancher la connexion électrique (2).

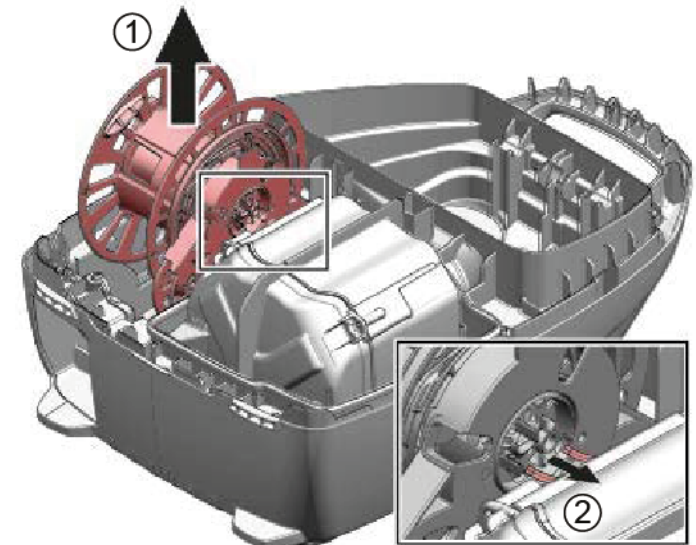

## Réparation

 L'enrouleur de câble est retiré.

## 5.2 Retirer le moteur du ventilateur

### Outillage nécessaire:

- 🔩 Tournevis TX15, pour têtes fendues hexalobulaires, Référence ISO 10664



### ⚠️ DANGER

#### Risque d'électrocution par des pièces conductrices de tension !

Mort par électrocution.

- ▶ Débrancher l'appareil du secteur minimum 60 secondes avant de démarrer la réparation.



### ⚠️ PRUDENCE

#### Arêtes vives !

Blessures par coupure

- ▶ Porter des gants de protection.



### ⚠️ ATTENTION !

#### Composants sensibles aux décharges électrostatiques !

Défaut ou panne de composants en raison de charges électrostatiques.

- ▶ Avant tout contact et mesure de ces composants, utiliser un système de protection électrostatique (ex. bracelet de mise à la terre).
- ▶ Empêcher tout contact entre ces composants et les matériaux plastiques capables de supporter une charge (films, etc.).
- ▶ Maintenir les groupes de composants, modules et platines de sorte qu'il y ait le moins de contact possible avec les bandes conductrices ou connecteurs.
- ▶ Ne pas placer ces composants trop proches de moniteurs ou télévisions.
- ▶ Utiliser pour le transport uniquement des matériaux conducteurs ou l'emballage d'origine.

1. Débrancher l'appareil du secteur.

2. 1. Ouvrir le cache du compartiment filtrant (1).
2. Retirer le filtre d'évacuation (2).

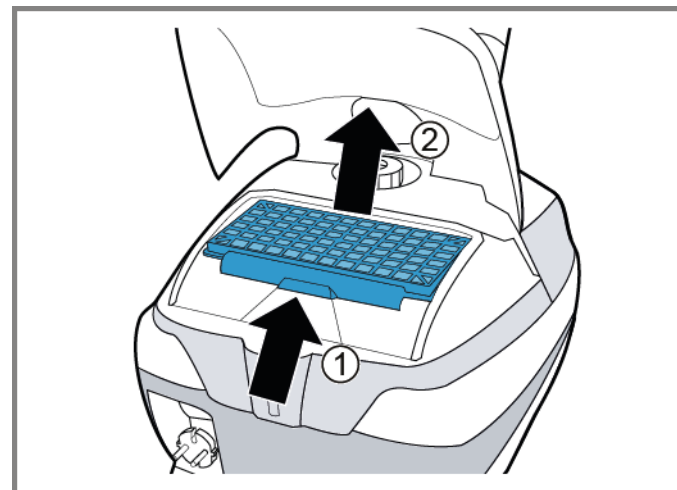

3. Retirer le joint.

## Réparation

4. Retirer trois vis.

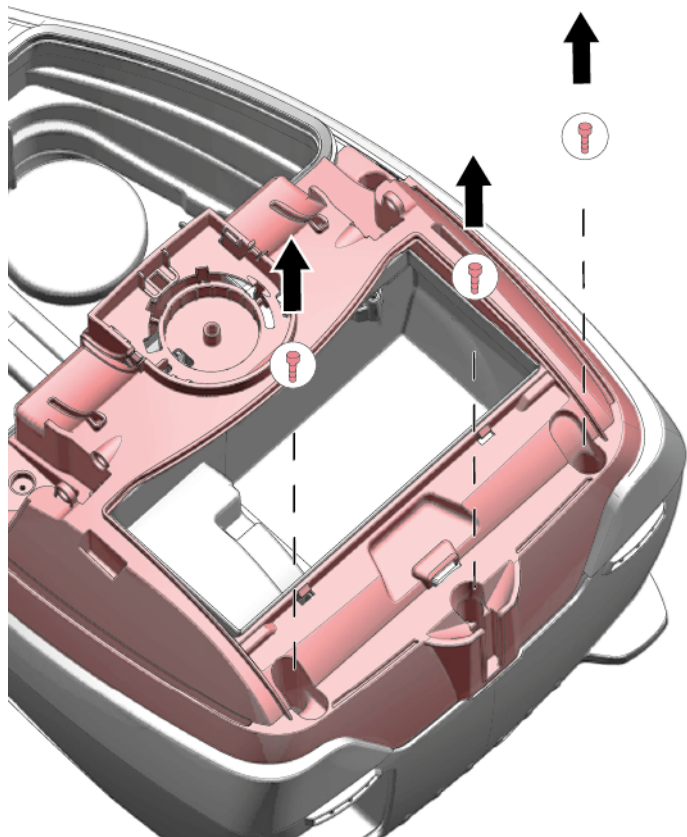

5. Fermer le cache du compartiment filtrant.

6. Ouvrir le cache.

7. Retirer quatre vis.

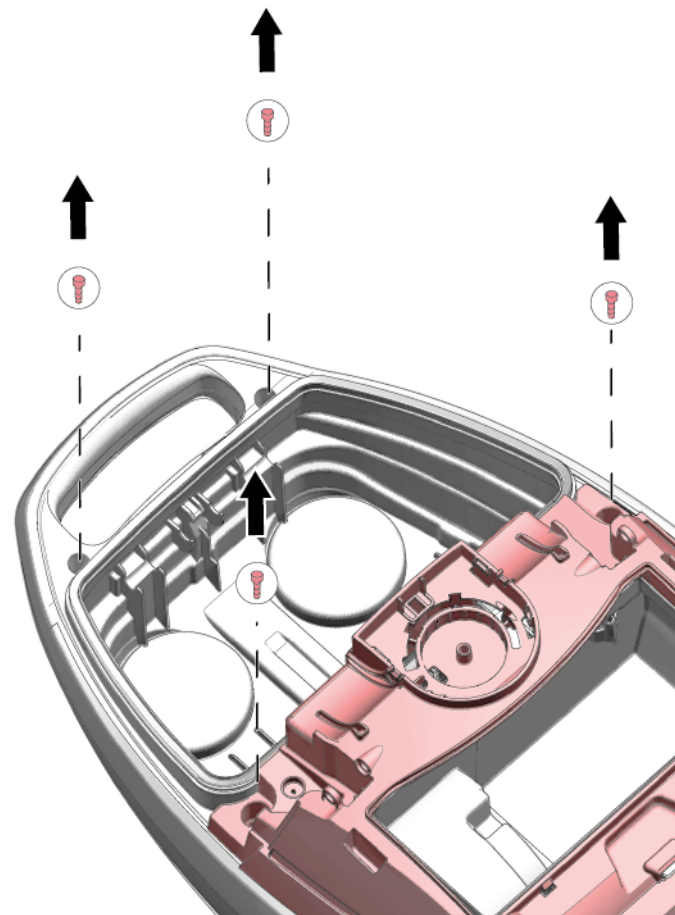

8. Retirer le boîtier supérieur.

9. Retirer le module de contrôle avec le module de l'interrupteur marche/arrêt.

## Réparation

10. Retirer la pièce de support avec l'isolation acoustique.

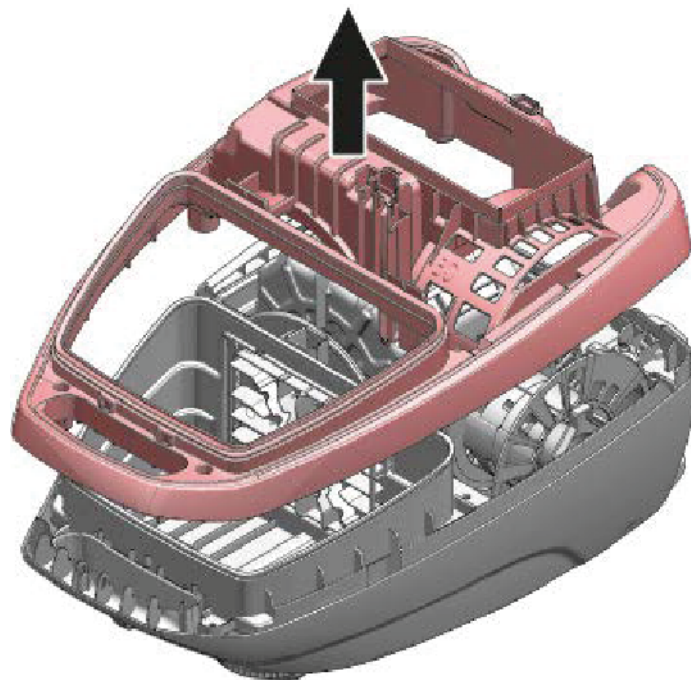

11. Retirer le boîtier du moteur.

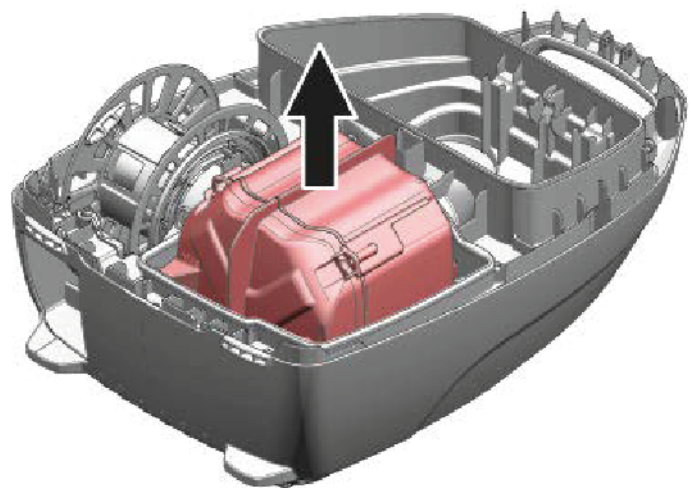

12. Retirer l'isolation acoustique.

13. 1. Retirer le moteur du ventilateur.  
2. Débrancher le câble de connexion et retirer le clapet.

➡ Le moteur du ventilateur est retiré.

## 5.3 Retirer l'interrupteur marche/arrêt

### Outillage nécessaire:

- 🔩 Tournevis TX15, pour têtes fendues hexalobulaires, Référence ISO 10664
- 🔥 Fer à souder Ajustable, 60 W, 230 V AC, température min. 200 °C, température max. 450 °C, type de pointe de soudage : en crayon [00341297]



### ⚠️ DANGER

#### Risque d'électrocution par des pièces conductrices de tension !

Mort par électrocution.

- ▶ Débrancher l'appareil du secteur minimum 60 secondes avant de démarrer la réparation.



### ⚠️ PRUDENCE

#### Arêtes vives !

Blessures par coupure

- ▶ Porter des gants de protection.



### ⚠️ ATTENTION !

#### Composants sensibles aux décharges électrostatiques !

Défaut ou panne de composants en raison de charges électrostatiques.

- ▶ Avant tout contact et mesure de ces composants, utiliser un système de protection électrostatique (ex. bracelet de mise à la terre).
- ▶ Empêcher tout contact entre ces composants et les matériaux plastiques capables de supporter une charge (films, etc.).
- ▶ Maintenir les groupes de composants, modules et platines de sorte qu'il y ait le moins de contact possible avec les bandes conductrices ou connecteurs.
- ▶ Ne pas placer ces composants trop proches de moniteurs ou télévisions.
- ▶ Utiliser pour le transport uniquement des matériaux conducteurs ou l'emballage d'origine.

1. Débrancher l'appareil du secteur.

2. 1. Ouvrir le cache du compartiment filtrant (1).  
2. Retirer le filtre d'évacuation (2).

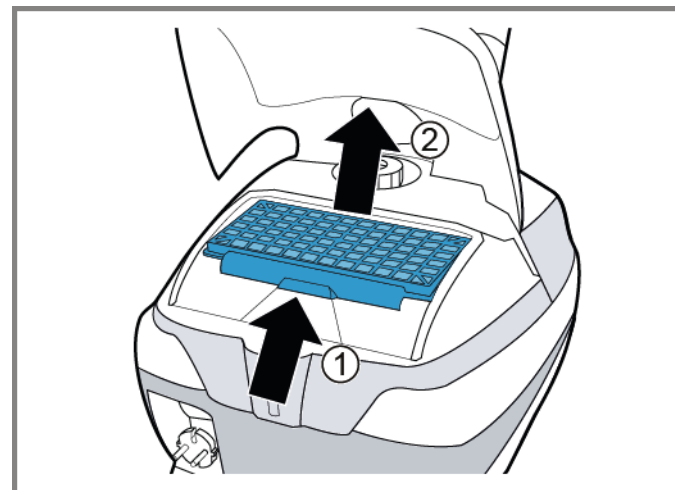

3. Retirer le joint.

## Réparation

4. Retirer trois vis.

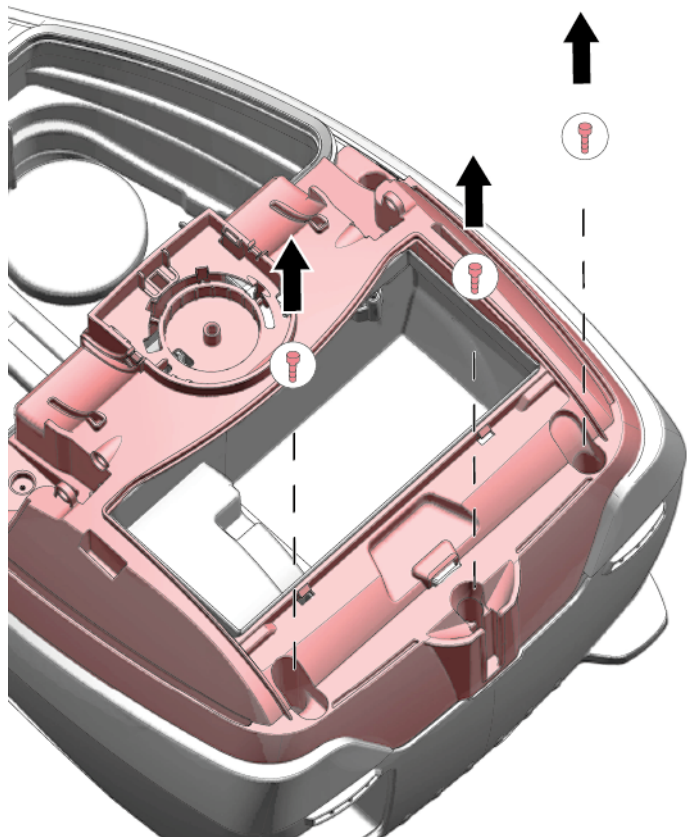

5. Fermer le cache du compartiment filtrant.

6. Ouvrir le cache.

7. Retirer quatre vis

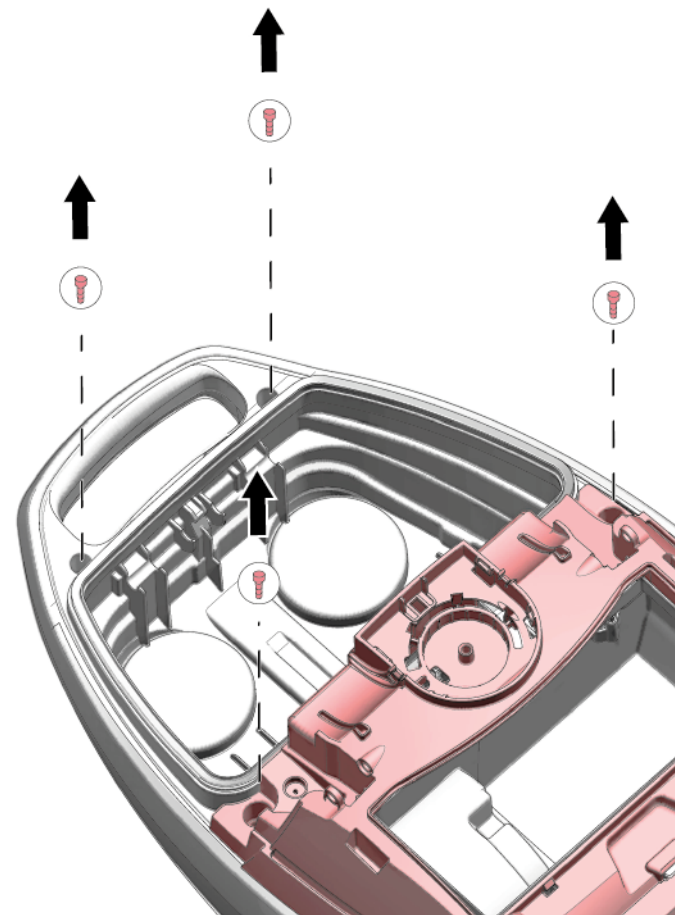

8. Retirer le boîtier supérieur.

9. Retirer le module de contrôle avec le module de l'interrupteur marche/arrêt.



10.

 **PRUDENCE**

**Risque de brûlure !**

La pointe du fer à souder devient chaude pendant le fonctionnement et peut provoquer des brûlures.

- ▶ Veiller à ne pas toucher la pointe pendant le processus de soudage/dessoudage.

Dessouder l'interrupteur marche/arrêt du module électronique.

 L'interrupteur marche/arrêt est retiré.