



**BOSCH**



**Register** your  
new device on  
MyBosch now and  
get free benefits:  
**[bosch-home.com/  
welcome](https://bosch-home.com/welcome)**

# Built-in induction hob

**PPI82560MS, PPI82560TW**

en      Operation and installation instruction









## Preface

- Thanks for your choosing Bosch cooking appliances. Please read this instruction carefully before you use the product and keep it properly for future reference. If you have any question, please contact local service centre or dealer.



BSH Electrical Appliance(JIANGSU) Co.,Ltd. reserves the final interpretation rights for the Operation and Installation Instruction. Any change of it will not be further notified.

## Table of contents

	<b>Important Safety Information</b> . . . . .	<b>3</b>
	Safety instruction . . . . .	3
	Causes of damage . . . . .	3
	Advice on saving energy . . . . .	3
	<b>Induction cooking</b> . . . . .	<b>4</b>
	Advantages of induction cooking . . . . .	4
	Suitable pans . . . . .	4
	<b>Your New Appliance</b> . . . . .	<b>5</b>
	Technical parameters . . . . .	5
	View of new appliance . . . . .	5
	Control panel . . . . .	5
	<b>Operation Instruction</b> . . . . .	<b>6</b>
	Residual heat indicator . . . . .	6
	Switching the hob on and off . . . . .	6
	Selecting a hotplate and heat setting . . . . .	6
	Cooking table . . . . .	6
	PowerBoost function . . . . .	8
	Time-setting options . . . . .	8
	Programming the cooking time . . . . .	8
	The kitchen timer . . . . .	9
	Cleaning lock function . . . . .	9
	Childproof lock . . . . .	9
	Automatic safety cut-out . . . . .	9
	Basic settings . . . . .	9
	Energy consumption indicator . . . . .	10
	Suitability test of tableware . . . . .	10
	<b>Care and Cleaning</b> . . . . .	<b>11</b>
	Cleaning surface of glass ceramics . . . . .	11
	Cleaning decorative strips of induction hob . . . . .	11
	<b>Maintenance and Service</b> . . . . .	<b>12</b>
	Faults analysis and troubleshooting . . . . .	12
	Normal noise while the appliance is working . . . . .	12
	Tips with good intention . . . . .	13
	<b>Installation Instruction</b> . . . . .	<b>13</b>
	Safety precautions . . . . .	13
	Prepare the kitchen cabinet . . . . .	13
	Installing and connecting the hob . . . . .	14
	<b>Package List</b> . . . . .	<b>15</b>

## Important Safety Information

- After you have unpacked this appliance, please dispose of the packaging materials via environmentally-friendly means to conserve an ideal environment.

### Safety instruction

- If you find the built-in induction hob is visibly damaged, do not use it, please contact local service centre immediately.
- The induction hob is specially designed for the purpose of home cooking, so that it should be installed in the kitchen for personal use.
- To use this appliance safely, adults and children who, as a result of the following conditions, are not capable of using this appliance, should not do so without the guidance or supervision of a responsible person:
  - Patient with physical, sensory or mental disability.
  - Lack of experience or knowledge.
- Please supervise the children to ensure they do not play with the appliance.
- Although this induction hob complies with current safety regulations and electromagnetic compatibility regulations, It is also possible that people with other types of device, such as pacemaker, hearing aid, could experience some discomfort.
- Do not control the induction hob with an additional timer or an independent remote control system.
- If you found the power cable of induction hob is damaged, it must be replaced with specified power cable or that bought from the customer service centre of the manufacturer, the replacement of power cable must be carried out by qualified personnel from the manufacturer or its maintenance department or equivalent.
- This appliance incorporates an earth connection for functional purposes only.
- The maximum altitude of use this appliance is 4000m.

### Caution!

The cooking process has to be supervised. A short term cooking process has to be supervised continuously.

### Warning – Danger of fire!

Do not store items on the cooking surfaces. If there is a drawer below the induction hob, this should not be used to store any flammable objects. Unattended cooking on a hob with fat or oil can be dangerous and may result in a fire.

Avoid overheating the oil, overheated oil can ignite and cause a fire!

In the event that the oil catches fire, never use water to put it out, switch off the induction hob immediately; You may put off the fire quickly by covering the cookware with a cover or dish.

### Warning – Risk of electric shock !

disconnect the appliance from the mains if the induction hob is broken or cracked.

### Attention: the high temperature surface!

Do not touch the hot areas of the induction hob. Do not place cutlery, lids or other metal objects on the surface of induction hob as they can heat up.

- Keep the hotplates and pan bases dry. If there is any liquid between the pan bases and hotplates, this could generate steam pressure while the induction hob is in use, this could cause the pan to shake abnormally.
- This induction hob is fitted with a fan at the lower section. If a drawer is fitted under the induction hob, do not keep small objects or paper in it, as if these small objects or paper are picked up, they could damage the cooling fan or affect the cooling system.
- Never rest hot pans on the control panel, the indicator area or the hob surround.
- Always switch off the induction hob using the power switch of the control panel after each use. Do not wait until the hob switches off automatically when the pan is removed.

### Causes of damage

- The rough bases of pans may scratch the hob.
- Salt, sugar and sand may scratch the ceramic glass. Do not place these objects on the hob or use ceramic glass of the induction hob as work surface.
- Hard or sharp objects may cause damage if they fall onto the hob.
- Spilt food may damage the induction hob. It should be removed immediately using a glass scraper.
- Unsuitable cleaning products may cause metal discoloration and damage on cookware.

### Advice on saving energy

- Choose pans which are the right size of the amount of food to be prepared. A large pan which is half full will consume a lot of energy.
- Always centre the pan on the hotplate and always cover the pan with the matching lid. Cooking without using the lid will consume more energy.
- We recommend not to place pans that have been used on a gas hob on the induction hob (The flame can deform the flatness of bottom). In case you have to use them, please check that bottom is flat.

## Induction cooking

### Advantages of induction cooking

Induction cooking involves a radical change to the traditional method of heating, as the heat is generated directly in the pan. It offers a number of advantages:

- Greater speed in cooking and frying.
- Reduced energy consumption.
- Cleaner and easier to use; Spilt food does not burn as much on the induction hob.
- Cooking control and safety; The induction hob suppliers or cuts off the heat as soon as the controls are operated. The induction hotplate stops supplying heat if the pan is moved before the power has been switched off.

### Suitable pans

- Please use the special induction hob cookware with the material and size that meet the requirements.
- Checking flatness of pan base: Put a ruler on the pan base, if no gap between the ruler and pan, it means the pan base is flat.
- Ferromagnetic pans are only pans which are suitable for induction cooking. In order to get good cooking results, the dimension of ferromagnetic pans should matches the hotplate. The pans made of the following materials (Pans as shown are recommended):
  - Cast iron
  - Specially stainless steel
  - Others specially designed cookware of induction cooking made from heat-diffusing materials

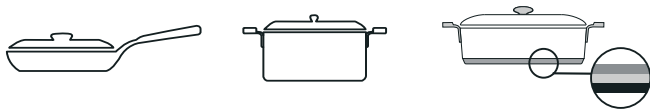

- Please use the magnet to determine if the size of the ferromagnetic part has met the requirements specified in this user manual. Pan manufacturers will usually indicate if their pans are suitable for induction cooking.

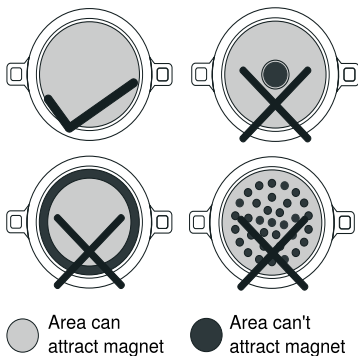

- Never use pans made of the following material:
  - Glass
  - Earthenware
  - Copper
  - Aluminium

- If no pan is placed on the hotplate, or the pan is not made of a suitable material or it is not a suitable size, the heat setting indicator of the induction hob will flash. Place a suitable pan on the hotplate to stop the indicator from flashing. If there is a delay of more than 90 seconds, the hotplate will switch off automatically.
- Do not heat empty pans and do not use pans with thin bases. Empty cookware can heat up so quickly that the base of the pan could melt and damage the induction hob's surface. In this case, please do not touch pan and switch off the induction hob directly. If it does not work after cooling, contact local service centre or distributor.

# Your New Appliance

## Technical parameters

Product code	PPI82560MS	PPI82560TW
Product model	CS35-PPI82560MS	CS35-PPI82560TW
Dimension (WxDxH) (mm)	780 x 450 x 65	780 x 450 x 65
Size of tapping (WxD) (mm)	700x400 Fillet 4xR20	700x400 Fillet 4xR20
Height above installation table (mm)	5.5	5.5
Panel	Black ceramic glass	Black ceramic glass
Net weight (kg)	10.5	10.5
Gross weight (kg)	13	13
Rated voltage	220V-240V~	220V~
Rated frequency	50/60Hz	60Hz
Left hotplate rated power (W)	3100 (Heat setting 9: 1800)	-
Right hotplate rated power (W)	3100 (Heat setting 9: 1800)	-
Total rated power (W)	3500	3500

## View of new appliance

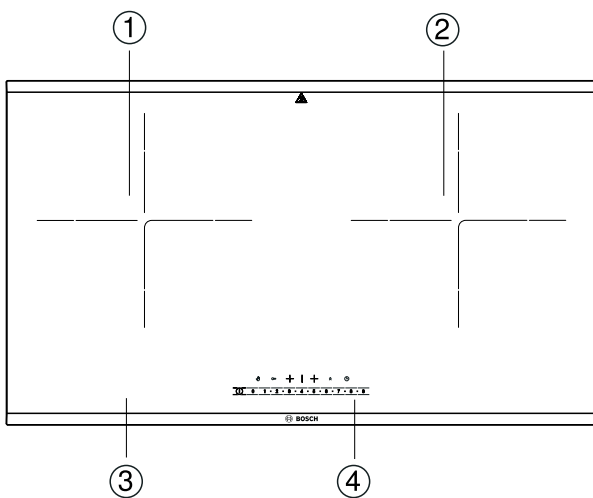





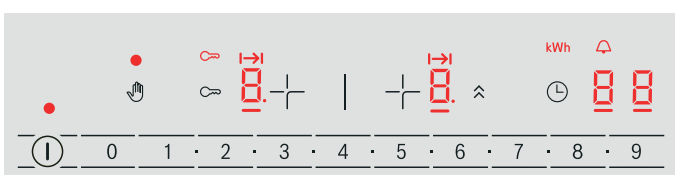

1. Left hotplate
2. Right hotplate
3. Ceramic glass
4. Control panel

**Note:** You can ascertain whether the pan has been placed at the centre of the hotplate according to the extended line of the crosses.

## Control panel





1. Main power switch : To switch the hob on and off.
2. Cleaning lock : To activate cleaning lock function.
3. Childproof lock : To activate childproof lock.
4. Hotplate selection : To select left hotplate or right hotplate.
5. PowerBoost : To activate PowerBoost function.
6. Time setting : To program the cooking time and kitchen timer.
7. Number 0 1 2 3...9: Use for heat setting and time program.

## Operation Instruction

### Residual heat indicator

- The hob has a residual heat indicator for each hotplate to show the hotplate which are still hot. Avoid touching the hot plate when the *H/h* indicator is on.
- Although the hob is switched off, the indicator will stay lit while the hotplate is hot.
- When the pan is removed before the hot plate is turned off, the *H/h* indicator and selected heat setting will be displayed alternately. *H* will be on when the temperature is very high, a while later *h* will be on, this indicates that the temperature has gone down, the residual heat indicator will go off after the induction hob has cooled down completely.

### Switching the hob on and off

- To switch on  
Touch the  symbol. A beep sounds. The indicator next to the main power switch and the hotplate indicators  light up. The hob is ready to use.
- To switch off  
Touch the  symbol until the indicator goes out. All hotplates are switched off. A beep sounds. The residual heat indicator remains lit until the hotplates have cooled down sufficiently.

#### Caution!



The hob switches off automatically if all hotplates have been switched off for some time.

The hotplate settings be saved after the hob have been switched off less then 4 seconds.

If you restart the hob in 4 seconds, the hotplate will follow up the previous setting such as heating setting and time programming.

### Selecting a hotplate and heat setting

- Touch the  symbol to switch on the hob.

1. Touch the  symbol for required hotplate. The  indicator lights up.
2. Then select the required heat setting from the settings range.  
Heat setting *1*= lowest setting.  
Heat setting *9*= highest setting.  
You can set the required heat setting by press number 1-9, then the heat setting appears in the hotplate display.

Every heat setting has an intermediate setting. This intermediate setting is marked with the  symbol.  
e.g. The heating setting *4*. indicate the heat setting higher than heating setting *4* and lower than heating setting *5*.

- Changing the heat setting  
Select the hotplate and then set the required heat setting in the digital zone.
- Switch off the hotplate  
Select the hotplate and then select heat setting  in the digital zone. The hotplate will be switched off and the residual heat indicator lights up.

#### Caution!

If no pan has been placed on the hotplate, the selected power level flashes. After a certain time has elapsed, the hotplate switches off.

If a pan has been placed on the hotplate before switching on the hob, it will be detected within a few seconds of pressing the main switch and the hotplate will be selected automatically. Once detected, select the power level within the next a few seconds or the hotplate will switch off.

If more than one pan is placed on the hob, only one will be detected when switching it on.

### Cooking table

The table shows which heat setting is suitable for each type of food. The cooking time may vary depending on the type, weight, thickness and quality of the food.

	Heat setting	Cooking time (mins)
<b>Melting</b>		
Chocolate coating	1 - 1.	-
Butter, honey, gelatine	1 - 2	-
<b>Heating and keeping warm</b>		
Stew, e.g. lentil stew	1. - 2	-
Milk*	1. - 2.	-
Heating sausages in water*	3 - 4	-
* Without lid		
** Turn several times		
*** Preheat to heat setting 8 - 8.		

	Heat setting	Cooking time (mins)
<b>Defrosting and heating</b>		
Spinach, frozen	3 - 4	15 - 25
Goulash, frozen	3 - 4	35 - 55
<b>Poaching, simmering</b>		
Potato dumplings*	4. - 5.	20 - 30
Fish*	4 - 5	10 - 15
White sauces, e.g. Béchamel sauce	1 - 2	3 - 6
Whisked sauces, e.g. sauce béarnaise, hollandaise	3 - 4	8 - 12
<b>Boiling, steaming, braising</b>		
Rice (with double the volume of water)	2. - 3.	15 - 30
Rice pudding***	2 - 3	30 - 40
Unpeeled boiled potatoes	4. - 5.	25 - 35
Boiled potatoes	4. - 5.	15 - 30
Pasta, noodles*	6 - 7	6 - 10
Stew	3. - 4.	120 - 180
Soups	3. - 4.	15 - 60
Vegetables	2. - 3.	10 - 20
Vegetables, frozen	3. - 4.	7 - 20
Cooking in a pressure cooker	4. - 5.	-
<b>Braising</b>		
Roulades	4 - 5	50 - 65
Pot roast	4 - 5	60 - 100
Goulash***	3 - 4	50 - 60
<b>Roasting/frying with little oil*</b>		
Escalope, plain or breaded	6 - 7	6 - 10
Escalope, frozen	6 - 7	6 - 12
Chop, plain or breaded**	6 - 7	8 - 12
Steak (3 cm thick)	7 - 8	8 - 12
Poultry breast (2 cm thick)**	5 - 6	10 - 20
Poultry breast, frozen**	5 - 6	10 - 30
Rissoles (3 cm thick)**	4. - 5.	20 - 30
Hamburgers (2 cm thick)**	6 - 7	10 - 20
Fish and fish fillet, plain	5 - 6	8 - 20
Fish and fish fillet, breaded	6 - 7	8 - 20
Fish, breaded and frozen, e.g. fish fingers	6 - 7	8 - 15
Scampi, prawns	7 - 8	4 - 10
Sautéing fresh vegetables and mushrooms	7 - 8	10 - 20
Stir-fry, vegetables, meat cut in Asian-style strips	7 - 8	15 - 20
Frozen dishes, e.g. roasted dishes	6 - 7	6 - 10
Pancakes (baked in succession)	6. - 7.	-
Omelette (cooked in succession)	3. - 4.	3 - 10
Fried eggs	5 - 6	3 - 6

\* Without lid

\*\* Turn several times

\*\*\* Preheat to heat setting 8 - 8.

	Heat setting	Cooking time (mins)
<b>Deep-fat frying* (150-200 g per portion in 1-2 l oil, deep-fat fried in portions)</b>		
Frozen products, e.g. chips, chicken nuggets	8 - 9	-
Croquettes, frozen	7 - 8	-
Meat, e.g. chicken portions	6 - 7	-
Fish, breaded or in beer batter	6 - 7	-
Vegetables, mushrooms, breaded or battered, tempura	6 - 7	-
Small baked items, e.g. doughnuts, fruit in batter	4 - 5	-

\* Without lid  
 \*\* Turn several times  
 \*\*\* Preheat to heat setting 8 - 8.

### PowerBoost function

- The PowerBoost function enables you to heat up large quantities of water faster than when using heat setting 9.
- This function can be activated for a hotplate, but under condition of only one hotplate was in use. Otherwise, **b** and **9** flash in the display for the selected hotplate. The heat setting 9 is then set automatically without activating the function.

#### Activating

- Select a hotplate.
- Touch the **^** symbol.  
The **b** indicator lights up. The function has now been activated.

#### Deactivating

- Select the hotplate.
- Touch the **^** symbol.  
The **b** indicator goes out and the hotplate switches back to the 9 heat setting.  
The function is deactivated.

**Note:** In certain circumstances, the PowerBoost function can switch itself off automatically in order to protect the electronic elements inside the hob.

### Time-setting options

Your hob has two timer functions:

- Programming the cooking time
- Kitchen timer

### Programming the cooking time

- You can set a cooking time of up to **99** minutes. The hotplate automatically switches off after the time that is set has elapsed.
- Setting procedure:
  - Select the hotplate and the required heat setting.
  - Touch the **⌚** symbol. The **l→l** display for the hotplate lights up. **00** lights up on the timer display.

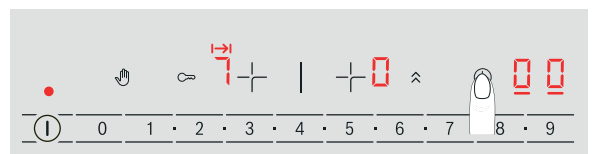

- Set the required time in the digital zone. The setting display in the time display (time unit: minutes). e.g. Setting cooking time 72 minutes:

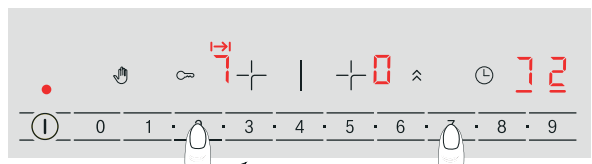

- Press number 7, it will be displayed in the single digits.
- Within the next 10 seconds, set the second number 2. It will be displayed in the single digits. The number 7 will be moved to the left. Then the cooking time 72 will be displayed in the time display. If you not continues to program time within 10 seconds, the current time display as the programmed time will start to count down.
- Changing or cancelling the time  
Select the hotplate and then touch the **⌚** symbol. Change the cooking time in digital zone or set **00** in order to cancel the time.
- Once the time has elapsed  
The hotplate switches off. A beep sounds. The time program function lights up **00** for 10 seconds in the display. When any symbol is touched, the indicator go out and the beeping stops.

#### Caution!

To set a cooking time of under 10 minutes, always touch 0 before you select the required value.









- Select the hotplate and then touch the **⌚** symbol to show the remaining cooking time. If the hob is switched off before the time has elapsed, the time program function will no longer be activated.



**Caution!**

Each hotplate can be programmed the different cooking time, touch the  symbol repeatedly to show the relevant hotplate and its remaining cooking time, or remaining time of kitchen timer in the timer display.



**The kitchen timer**

- You can use the kitchen timer to set a time of up to 99 minutes. The kitchen timer can run no matter the hob is locked or switched off. This function does not automatically switch off a hotplate.
- Setting procedure
  1. Touch the  symbol repeatedly until the  indicator lights up.  lights up in the timer display.
  2. Set the required time in the digital zone. After a few seconds, the time begins to elapse.
- Changing or deleting the time  
Touch the  symbol repeatedly until the  indicator lights up. Change the cooking time in the digital zone or set  in order to delete the programmed cooking time.
- When the time has elapsed  
An warning signal sounds.  appears in the timer display and the  indicator lights up. The displays go out after 10 seconds.  
When any symbol is touched, the indicator go out and the beeping stops.



**Cleaning lock function**

- Cleaning the hob panel when the hob is ON may change the settings.  
To avoid this, you can use the cleaning lock function.
- Press the  symbol. The control panel will remain locked for approximately 35 seconds.  
The surface of the control panel can now be cleaned without risk of changing the settings.
- After the time has elapsed, a warning beep will sound and the function is deactivated.





**Caution!**

The lock does not apply to the  symbol or to the main switch . The cleaning lock function can be deactivated and the hob can be switched off at any time.

**Childproof lock**









- You can use the childproof lock to prevent children from switching on the hob.
- The hob must be switched off, then activating and deactivating the childproof lock.
- To activate:  
Touch the  symbol for approx. five seconds until the indicator lights up.  
The hob is locked. Only kitchen timer effective, other function invalid.
- To deactivate:  
Touch the  symbol for approx. five seconds until the indicator goes out. The lock is released. The induction hob can be used.
- Automatically childproof lock:  
With this function, the childproof lock automatically activates when a hob is switched off.  
You can find out how to switch the automatic childproof lock on in the “User settings” section.

**Automatic safety cut-out**

- If a hotplate operates for an extended period and no settings are changed, the automatic safety shut-off is activated.  
The hotplate stops heating. ,  and the residual heat indicator  or  flash alternately in the hotplate display.  
When you touch any symbol, the display switches off. The hotplate can now be set again.
- The point at which the safety shut-off becomes active depends on which heat setting has been set.

**Basic settings**

The appliance has various basic settings. You can adapt these to suit your cooking habits.

Display	Function
	<b>Automatic childproof lock</b>  Manual*.  Automatic.  Function deactivated.
	<b>Audible signals</b>  Confirmation and fault signals are switched off.  Only the fault signal is switched on.  Only the confirmation signal is switched on.  All signal tones are switched on.*

\* Factory settings

Display	Function
$c3$	<b>Display energy consumption</b> $0$ Switched off.* $1$ Switched on.
$c5$	<b>Automatically programming the cooking time</b> $00$ Switched off.* $01-99$ Time until automatic switch-off.
$c6$	<b>Duration of the timer-end signal tone</b> $1$ 10 seconds.* $2$ 30 seconds. $3$ 1 minute.
$c7$	<b>Power management function. Limiting the total power of the hob</b> $0$ Switched off.* $1$ 1000 W minimum power. $1.$ 1500 W. $2$ 2000 W. ... $9$ or $9.$ Maximum power of the hob.
$c9$	<b>Time for selecting the hotplate</b> $0$ Unlimited: The hotplate that was set last remains selected.* $1$ Limited: The hotplate only remains selected for a few seconds.
$c12$	<b>Checking cookware and cooking results</b> $0$ Not suitable $1$ Not perfect $2$ Suitable
$c0$	<b>Restoring the factory settings</b> $0$ Individual settings.* $1$ Restore factory settings.

## \* Factory settings

- To access the basic settings:
  1. Switch on the hob by press  $\textcircled{1}$  symbol.
  2. Within ten seconds, touch and hold the  $\textcircled{-}$  symbol until beeps sound, and  $--$  lights up on the timer display. Touching the  $\textcircled{-}$  symbol again,  $c$  and  $1$  flash alternately on the displays of right hotplate, takes you to the basic settings.
  3. Touch the  $\textcircled{-}$  symbol repeatedly until the required function is displayed.
  4. Then select the required setting from the settings area. The new setting will appear on the time indicator display.
  5. Touch the  $\textcircled{-}$  symbol until beeps sound, the setting have been saved.

**Note:**

When you select the  $c12$  setting, the  $c$  statically on the display,  $1$  and  $2$  alternately on the display. The result for the quality and speed of the cooking process will appear on the hotplate display.

Turn off the hob by touch  $\textcircled{1}$  symbol, you can leave the basic setting, but the new setting will not be saved.

**Energy consumption indicator**

- This function indicates the total amount of energy consumed by this hob the last time it was used for cooking. Once switched off, the energy consumption in kWh is displayed for 10 seconds. You can find out how to switch this function on in the section on "Basic settings".

**Suitability test of tableware**

- This function can be used to check the speed and quality of the cooking process depending on the cookware. The result is a reference value and depends on the properties of the cookware and the hotplate being used.

1. With the cookware still cold, fill it with approx. 200 ml of water and place it on the centre of the hotplate with the diameter that most closely matches that of the base of the cookware.
  2. Go to the basic settings and select the  $\square$   $i$   $\square$  setting.
  3. A will flash on the hotplate display.  
The function has now been activated.  
After 10 seconds, the result for the quality and speed of the cooking process will appear on the hotplate display.
- Check the result using the following table:

$\square$	The cookware is not suitable for the hotplate and will therefore not heat up*
$i$	The cookware is taking longer to heat up than expected and the cooking process is not going as well as it should.
$\square$	The cookware is heating up correctly and the cooking process is going well.

**Note:**

If the diameter of the hotplate used is much smaller than the diameter of the cookware, only the middle of the cookware can be expected to heat up. This may result in the cooking results not being as good as expected or being less than satisfactory.

- You can find information on this function in the section on "Basic settings".  
You can find information on the type, size and positioning of the cookware in the sections on "Suitable pans".



## Care and Cleaning

Clean the induction hob after each use. This will prevent spillages from burning, and it remain in the best working condition.

### Cleaning surface of glass ceramics

- Only use cleaning products which are recommend for ceramic glass.
- Remove stubborn stains with a glass scraper. You can buy it from local service centre.

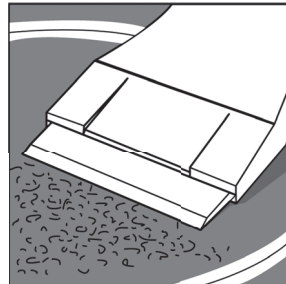

1. Push out the blades of the scraper.
  2. Clean the surface of the induction hob with the blade.  
Do not clean the surface of the induction hob with the scraper cover as this could scratch the surface.  
The blade is very sharp, beware of cuts.  
Keep in a safe place after use.
- Never use:  
Corrosive cleaning products, such as stain removers and oven spray.  
Abrasive products.  
High-pressure cleaners or steam cleaners.

### Cleaning decorative strips of induction hob

- Only use slightly soapy warm water to cleaning the decorative strips.
- Never use sharp of abrasive products, to prevent damage to it.
- Do not use the glass scraper.

## Maintenance and Service

### Faults analysis and troubleshooting

- Malfunctions are generally caused by minor faults. Before contacting the customer service, make sure you have read the following.

Display	Malfunction	measure
No indication	Power supply was disconnected	Use other electrical device to check if the power supply was disconnected.
	The appliance has not been correctly connected	Check if the appliance has been connected correctly.
	Electronic system error	If the checks above do not remedy the malfunction, contact the after sales service centre.
<i>E 0 108</i>	Fan malfunction	Please contact the after sales service centre.
<i>F6</i>	Overheating of electronic system, corresponding hotplate has switched off.	Wait until the electronic system has cooled down, then press any button. If the indication continues, contact the after sales service centre.
<i>F2/F4/F5</i>	Overheating of control panel, all hotplate have switched off.	Wait until the electronic system of control panel has cooled down, then press any button. If the indication continues, contact the after sales service centre.
<i>F 1</i>	Hotplate overheated and was switched off to protect the hob.	Wait until the hotplate has cooled down and switch on the hob again.
<i>E2030</i> <i>E2 130</i> <i>E203 1</i> <i>E2 13 1</i> <i>E2032</i> <i>E2 132</i>	Hotplate temperature sensor malfunction.	Switch off the induction hob, then switch on the hob again after a few seconds. If the indication continues, contact the after sales service centre.
<i>E9000</i> <i>E90 10</i>	Voltage incorrect, outside normal operating limits	Please contact the local power supply board.
<i>F8</i>	It was long time working as same condition, the hob was switched off automatically.	Press any button, the error disappear. Then operate the hob.

Do not place hot pans on the control panel.

#### Note:

If *E* appears in the display, the sensor for the relevant hotplate must be pressed and held in order to read the fault code of 4 digits.

- If the fault code is not listed in the table, disconnect the hob from the power supply, wait 30 seconds and connect it again. If the display appears again, contact technical after-sales and tell them the precise fault code.

### Normal noise while the appliance is working

Induction heating technology is based on the creation of electromagnetic fields which enable heat to be generated directly on the base of the pan. Depending on the construction of the pan, these electromagnetic fields may produce certain noises or vibrations as detailed below:

- A low buzzing noise, like a transformer  
This noise is produced when cooking with high power levels. It is the quantity of energy transferred from the induction hob to the pan which causes the noise. This

noise will disappear or lessen as the power level is reduced.

- A low whistle  
This noise is produced when the pan is empty. The noise disappear as soon as food or water is added to the pan.
- Sizzling  
This noise is produced by pans made of composite materials. The noise is caused by the vibration of the contact surfaces. This noise comes from the cookware and may vary with the quantity of food and method of cooking.
- High-pitched whistling  
This noise is mostly produced by pans made of composite materials whenever they are used at full heating power and at the same time on two hotplates. This whistling disappears or lessens when the power is reduced.
- Noise from the fan  
For the electronic system to run properly, the induction hob must operate under controlled temperatures.

Thus, the induction hob is fitted with a fan which starts working after detecting the temperature at different power levels.

If the temperature detected is still too high, the fan will continue to work even after the induction hob has been switched off.

The noises described in this section are normal. They are part of induction heating technology and do not indicate a malfunction.

## Tips with good intention

**⚠ Warning** – Only technicians who have received professional training and obtained related qualification can maintain the induction hob. No other persons should maintain the induction hob without permission, to avoid serious consequences.

- If you have a problem with your appliance, please refer to "Faults Analysis and Troubleshooting" before calling service.
  - Please make sure you have the following information to hand, as this will help us deal with your query more quickly and efficiently, and save your unnecessary expenses:
    - exact address and telephone number
    - detailed description of the fault
    - date of receipt or invoice
    - product number(E-Nr)
    - production date(FD)
- Before the service engineer visiting, please prepare the proof of receipt or invoice in advance.

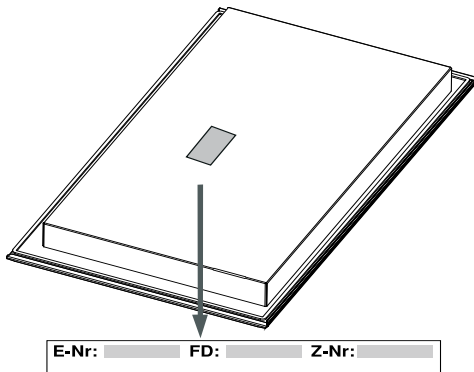

## Installation Instruction

### Safety precautions

- The installation, electrical installation, connect the appliance, must be carried out by technicians from or authorised by local service centre, the guidelines set out by the electricity provider must be followed. The manufacturer shall not be liable for any injury and damage caused as a result of improper installation.
- Do not install the induction hob on the top of a refrigerators, dishwashers, ovens, washing machines or similar appliances.
- This appliance should only be used with an earthed connection.
- The power cable must be positioned so that it does not touch any of the hot parts of the induction hob.

### Prepare the kitchen cabinet

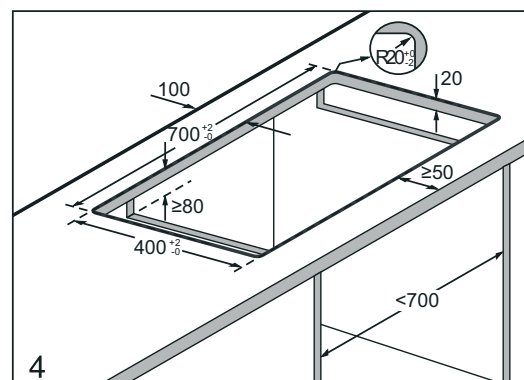
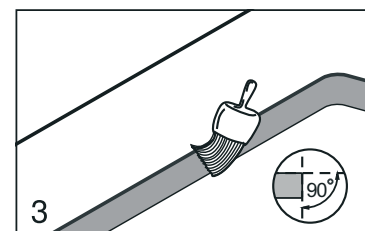
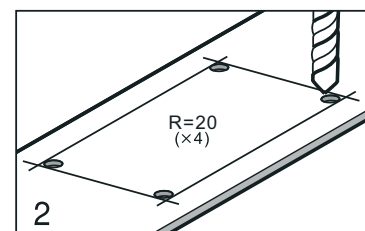
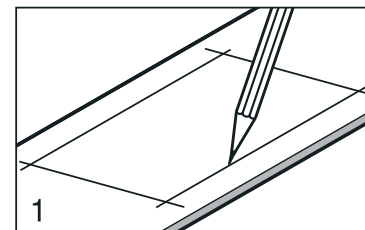

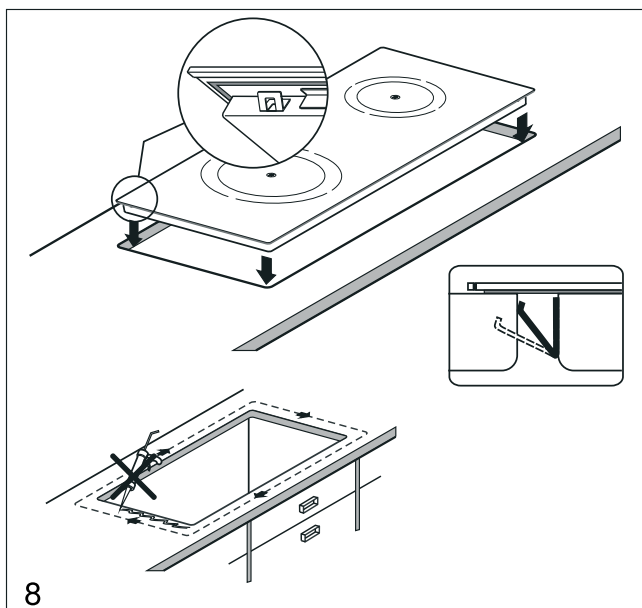
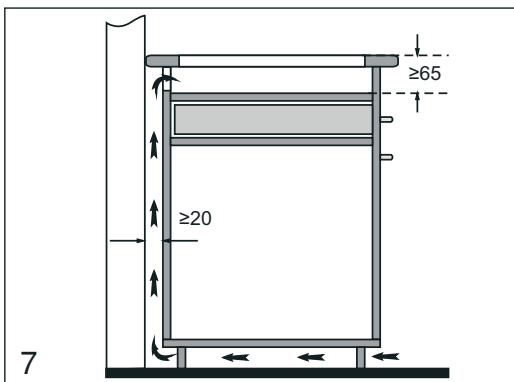
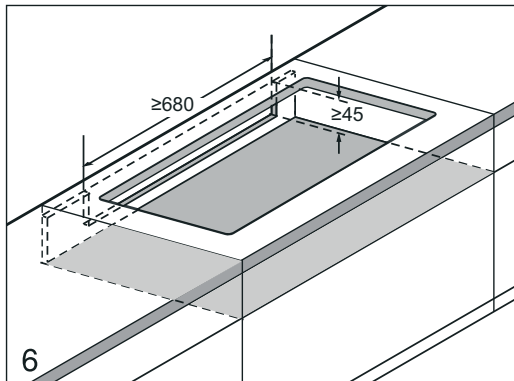
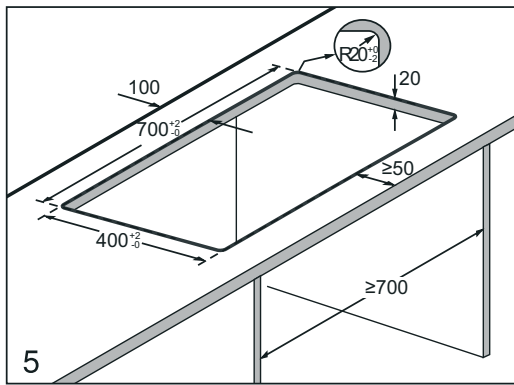

- The worktop should be flat, horizontal and firm. An aperture should be cut before the appliance is installed.

Remove any shavings, as these can affect the operation of the electrical components. When the cutting has been completed, the kitchen cabinet's stability should be checked again.

- The kitchen cabinet to be fitted must resist temperatures of up to 90°C.
- The worktop dimension: width at least 550mm, thickness 20mm (See picture 4).
- The gap between the aperture and side wall must be at least: 40mm.  
It is not recommended that the induction hob be placed between two side walls but, if this is the case, a gap of at least 200mm should also be left on one side.
- If the induction hob is installed above a sterilizer there must be a gap of 70mm from the top of worktop to the top of the sterilizer.
- If the induction hob is installed above a drawer, the minimum worktop thickness around the hob must be 20mm.
- If the gap between the two side panels of the kitchen cabinet is less than 700mm, an aperture must be cut 80mm from the top of worktop between the two side panels (See picture 4)
- Take the hob ventilation into consideration:  
A 680mm wide and 45mm high aperture must be cut at the top section at the back of the kitchen cabinet (See picture 6).  
There must be a gap of 20mm between the back of the kitchen cabinet and the kitchen wall (See picture 7).  
If the induction hob is installed above a drawer, allow a gap of 65mm between the drawer and the top section of the hob.
- Installation method: clamp the four spring sheets attached to the product to the corresponding for installation positions on the back shell.  
As there are sealing strips below the induction hob's control panel, there is no need to seal the induction hob and worktop with silicone sealant (See picture 8).

### Installing and connecting the hob

- See the name plate (see bottom of induction hob) for the voltage.
- Make sure the electrical circuit, socket and fuse at user's house complied with required 16A electrical installation.

#### For PPI82560MS:

- Connect according to the connector diagram (see figure) only.

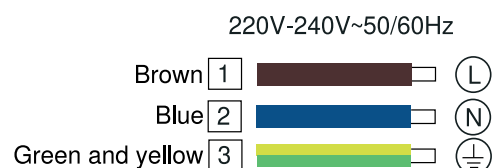

The earth wire (green and yellow(3)) should be connected firstly and disconnected lastly. It should also be longer than the others, so that even if the hob is moving the other wires can be disconnected before the earth wire.

- Do not trap the lead during installation and do not guide it over sharp edges.
- Removing the hob**  
Disconnect the cooker from the power supply. Push out the hob from below.  
The disconnection is achieved by having the plug accessible or by incorporating a switch in the fixed wiring in accordance with the wiring rules. Switches intended to ensure all-pole disconnection of cooker, shall be directly connected to the supply terminals and shall have a contact separation in all poles, providing

full disconnection under overvoltage category III conditions.

**For PPI82560TW:**

- The hob must be grounded. A three pin plug is provided, and this plug must be inserted in a truly grounded receptacle.
- Do not trap the lead during installation and do not guide it over sharp edges.
- Removing the hob**  
The disconnection is achieved by having the plug accessible, disconnect the cooker from the power supply. Push out the hob from below.

## Package List

No.	Component Name	Quantity	Unit	Remark
1	Induction hob	1	PC	
2	Operation and installation instruction	1	Set	
3	Spring sheet	1	Set	





## Thank you for buying a Bosch Home Appliance!

Register your new device on MyBosch now and profit directly from:

- **Expert tips & tricks for your appliance**
- **Warranty extension options**
- **Discounts for accessories & spare-parts**
- **Digital manual and all appliance data at hand**
- **Easy access to Bosch Home Appliances Service**

Free and easy registration – also on mobile phones:  
[www.bosch-home.com/welcome](http://www.bosch-home.com/welcome)



## Looking for help? You'll find it here.

Expert advice for your Bosch home appliances, need help with problems or a repair from Bosch experts.

Find out everything about the many ways Bosch can support you:

[www.bosch-home.com/service](http://www.bosch-home.com/service)

**Contact data of all countries are listed in the attached service directory.**

**BSH ELECTRICAL APPLIANCES (JIANGSU) CO., LTD.**

No.208 Yaoxin Road, Nanjing

Economic Technological Development Zone,

Post Code: 210046



8001208182  
20201001