



SIEMENS

Fridge-freezer

組合式冷凍冷藏冰箱

KD..N..

[en] Instruction manual  
[zh-hk] 使用說明書



Register your product on My Siemens and discover  
exclusive services and offers.  
[siemens-home.bsh-group.com/welcome](https://siemens-home.bsh-group.com/welcome)

The future moving in.

Siemens Home Appliances

---

<b>en</b>	<b>Table of Contents</b>	<b>3</b>
-----------	--------------------------	----------

---

<b>zh-hk</b>	<b>目錄</b>	<b>21</b>
--------------	-----------	-----------

---

---

## Contents

Safety and warning information .....	3	Helpful hints and tips .....	15
Installing your new refrigerator.....	6	Cleaning and care .....	17
Description of the refrigerator .....	11	Troubleshooting .....	18
Control panel .....	12	Disposal of the refrigerator .....	20
Using your refrigerator .....	13		



## Safety and warning information

For your safety and correct usage before installing and first using the refrigerator, read this user manual carefully, including its hints and warnings.

To avoid unnecessary mistakes and accidents, it is important to make sure that all people using the refrigerator are thoroughly familiar with its operation and safety features.

Keep this instruction manual and be sure that they remain with the refrigerator if it is moved or sold, so that anyone, will be properly informed on usage and safety notices.

- This refrigerator can be used by children aged from 8 years and above and persons with reduced physical, sensory or mental capabilities or lack of experience and knowledge if they have been given supervision or instruction concerning use of the refrigerator in a safe way and understand the hazards involved. Children shall not play with the refrigerator. Operation shall not be made by children without supervision.
- Keep all packaging away from children as there is a risk of suffocation.

---

## Safety and warning information

- If you are discarding the refrigerator, pull the plug out of the socket, cut the connection cable (as close to the refrigerator as you can) and remove the door to prevent children playing from suffering an electric shock or from closing themselves inside it.
- If this refrigerator, featuring a magnetic door seals, is to replace an older refrigerator having a spring lock on the door or lid, be sure to make the spring lock unusable before you discard the old refrigerator. This will prevent it from becoming a death trap for a child.

### General safety



- **WARNING** — This refrigerator is intended to be used in household such as  
-staff kitchen areas in offices and other working environments;  
-farm houses and by clients in hotels, -motels and other residential type environments;  
-catering and similar nonretail applications
- **WARNING** — Do not store explosive substances such as aerosol cans with a flammable propellant in this refrigerator.
- **WARNING** — If the supply cord is damaged, it must be replaced by the manufacturer, its service agent or similarly qualified persons in order to avoid a hazard.

- **WARNING** — Keep ventilation openings, in the refrigerator enclosure or in the built-in structure, clear of obstruction.
- **WARNING** — Do not use mechanical devices or other means to accelerate the defrosting process, other than those recommended by the manufacturer.
- **WARNING** — Do not damage the refrigerant circuit.
- **WARNING** — Do not use electrical refrigerators inside the food storage compartments of the refrigerator, unless they are of the type recommended by the manufacturer.



### Electrical safety

1. The power cord must not be lengthened.
2. Make sure that the power plug is not crushed or damaged. A crushed or damaged power plug may overheat and cause a fire.
3. Make sure that children cannot access the main plug of the refrigerator.
4. Do not pull the main cable.
5. If the power plug socket is loose, do not insert the power plug. There is a risk of electric shock or fire.
6. You must not operate the refrigerator without the interior lighting lamp cover.
7. The fridge is only applied with power supply of single phase alternating current of 220 ~ 240V/50Hz.

## Daily use

---

- Do not store flammable gases or liquids in the refrigerator. There is a risk of an explosion.
- Do not operate any electrical devices in the refrigerator (eg. electric ice cream makers, mixers etc.).
- When unplugging always pull the plug from the mains socket, do not pull on the cable.
- Do not place hot items near the plastic components of this refrigerator.
- Do not place food products directly against the air outlet on the rear wall.
- Store pre-packed frozen food in accordance with the frozen food manufacturer's instructions.
- The refrigerator manufacturer's storage recommendations should be strictly adhered to. Refer to relevant instructions for storage.
- Do not place carbonated or fizzy drinks in the freeze compartment as it creates pressure on the container, which may cause it to explode, resulting in damage to the refrigerator.
- Frozen food can cause frost burns if consumed straight from the freezer compartment.
- Do not place the refrigerator in direct sunlight.
- Keep burning candles, lamps and other items with naked flames away from the refrigerator so that do not set the refrigerator on fire.
- The refrigerator is intended for keeping food stuff and/or beverages in normal household as explained in this instruction manual. The refrigerator is heavy. Care should be taken when moving it.
- Do not remove nor touch items from the freezer compartment if your hands are damp/wet, as this could cause skin abrasions or frost/freezer burns.
- Never use the base, drawers, doors etc. to stand on or as supports.

- Frozen food must not be refrozen once it has been thawed out.
- Do not consume ice popsicles or ice cubes straight from the freezer as this can cause freezer burn to the mouth and lips.
- To avoid items falling and causing injury or damage to the refrigerator, do not overload the door racks or put too much food in the hyperFresh crisper compartment.

## Caution! Care and cleaning

---

- Before maintenance, switch off the refrigerator and disconnect the mains plug from the mains socket.
- Do not clean the refrigerator with metal objects, steam cleaner, ethereal oils, organic solvents or abrasive cleansers.
- Do not use sharp objects to remove frost from the refrigerator. Use a plastic scraper.

## Installation Important!

---

- For electrical connection carefully, follow the instructions given in this manual.
- Unpack the refrigerator and check if there are damages on it. Do not connect the refrigerator if it is damaged. Report possible damages immediately to the place you bought it. In this case retain packing.
- It is advisable to wait at least 4 hours before connecting the refrigerator to allow the oil to flow back in the compressor.
- Adequate air circulation should be around the refrigerator, lacking this leads to overheating. To achieve sufficient ventilation, follow the instructions relevant to installation.

- Wherever possible the back of the product should not be close to a wall to avoid touching or catching warm parts (compressor, condenser) to prevent the risk of a fire, follow the instruction relevant to installation.
- The refrigerator must not be locate close to radiators or gas cookers.
- Make sure that the mains plug is accessible after the installation of the refrigerator.

## Service

- Any electrical work required for the refrigerator should be carried out by qualified electrician or competent person.
- This product must be serviced by an authozied Service Center, and only genuine spare parts must be used, otherwise warranty maybe invalid.

## Installing your new refrigerator

Before using the refrigerator for the first time, you should be informed of the following tips.

### Ventilation system of refrigerator



In order to improve efficiency of the cooling system and save energy, it is necessary to maintain good ventilation around the refrigerator for the dissipation of heat. For this reason, sufficient clear space should be available around the refrigerator.

Recommendation : It is advisable for there to be at least 75mm of space from the back to the wall, at least 100mm from the top, at least 100mm from its side to the wall and a clear space in front to allow the doors to open 135° . As shown in following diagrams.

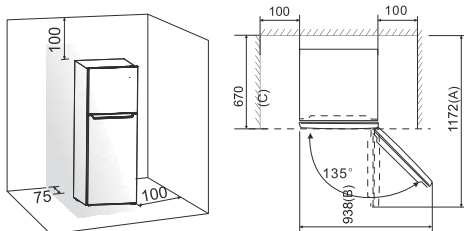

Note:

- This refrigerator performs well within the climate class from SN to T showed in the table below.

It may not work properly if being left at a temperature above or below the indicated range for a long period.

Climate class	Ambient temperature
SN	+10°C to +32°C
N	+16°C to +32°C
ST	+16°C to +38°C
T	+16°C to +43°C

- Install your refrigerator in a dry place to avoid high moisture.
- Keep the refrigerator out of direct sunlight, rain or frost.  
Keep the refrigerator away from heat sources such as stoves, fires or heaters.

## Leveling of refrigerator

- For sufficient leveling and air circulating in the lower rear section of the refrigerator, the bottom feet may need to be adjusted.  
You can adjust them manually by hand or by using a suitable spanner.
- To allow the doors to selfclose, tilt the top backwards by about 10mm.

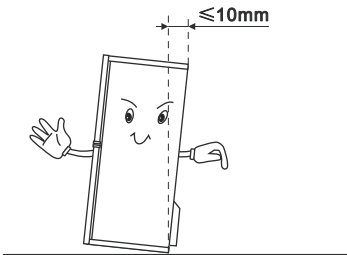





## Reversing the door

The side at which the door opens can be changed, from the right hinge (as supplied) to the left hinge if the installation site requires.

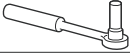
**Warning!** When reversing the door, the refrigerator must not be connected to the mains. Ensure that the plug is removed from the mains socket.

## Tools you will need

		
8mm socket wrench	Cross-shaped screwdriver	
		
Thin-blade screwdriver	Monkey wrench	8mm wrench

**Note:** Before you lay down the refrigerator in order to access to the base you should rest it on soft foam packaging or similar material to avoid damaging the backboard of the refrigerator. To reverse the door the following steps are generally recommended.

1. Install the refrigerator upright. Open the upper door to take out all door racks (to avoid racks damaged) and then close the door.

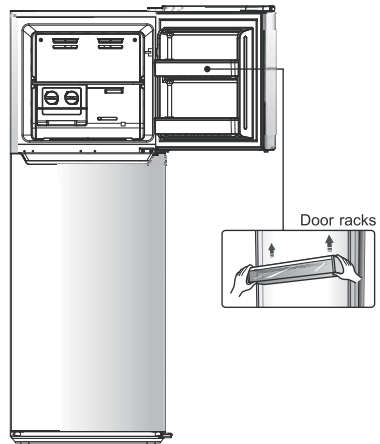

2. Stand the refrigerator upright, first remove the screw cover ① and loose the screw ② and unscrew the upper hinge cover ③ which is at the top right corner of the refrigerator, and use a putty knife or thin-blade screwdriver to prize the screw hole cover ④ which is at the top left corner of the refrigerator.

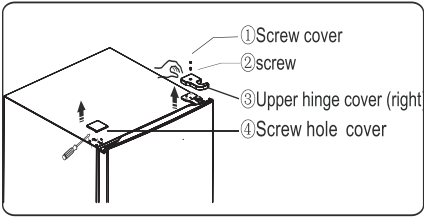

3. Unscrew the flange screws ① which are used for fixing the right upper hinge part ②. Lift the upper door and place it on a padded surface to prevent it from scratching.

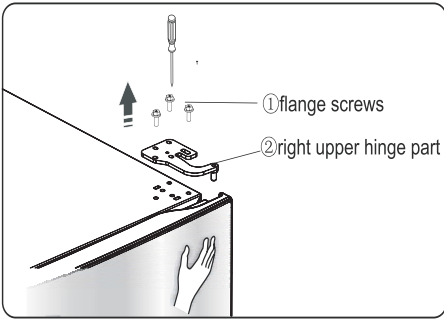

Note: Please hold the upper door by hand during step 3 to prevent door dropping.

4. Remove the upper door and place it on a smooth surface with its panel upwards. Loose screws ②, detach part ①, then install part ① to the left side with screws ②

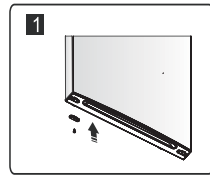
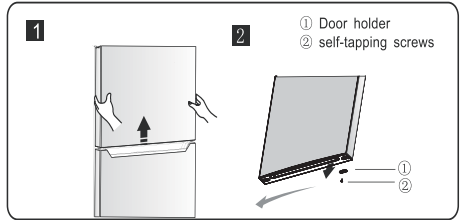

5. Loose screws used to fix the middle hinge and remove middle hinge. Then remove the lower door.

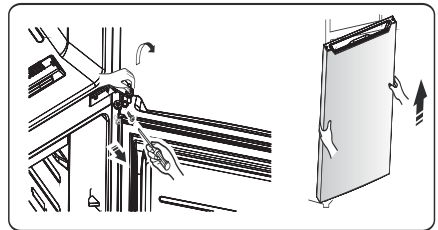



6. Place the lower door on a smooth surface with its panel upwards. Loose ② screws detach part ①.

Then install part ① to corresponding position on left side together with screws ②.

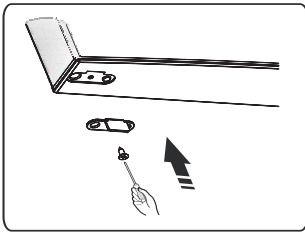
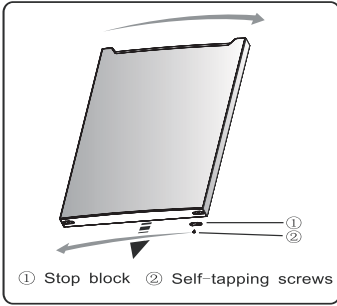

7. Change screw hole covers on middle cover plate from left to right (as shown in figure below).

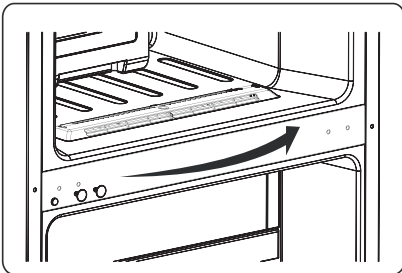

8. Place refrigerator flatwise, remove part ③ and then loose screws ④. Remove part ② and part ①.

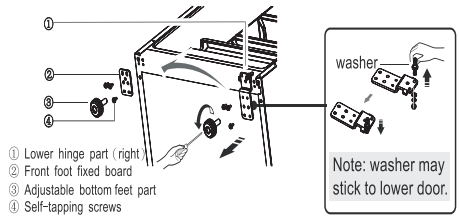

9. Screw out lower hinge, change it to the near hole site, and then screw up and mount washer.

10. Just remount to the step 8, change part ① to left and part ② to right and then fix them with screws ④. Finally install part ③.

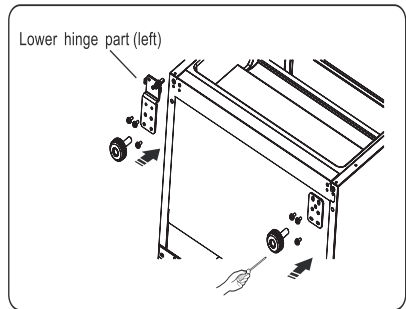

11. Move the lower door and adjust its position to align lower hole site and upper hinge axis. Turn the middle hinge by 180, change the washer on the axis to the upper side, adjust the middle hinge to the appropriate position and then install it.

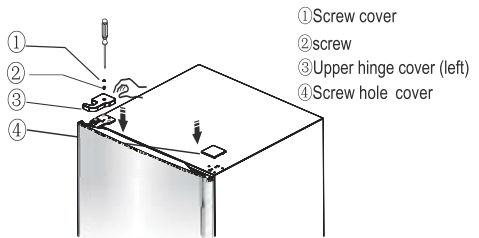
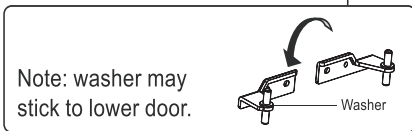

14. Open the upper door, mount door racks and then close it.

12. Screw out The upper hinge axis, turn the upper hinge over and fix axis on it. Then place it at side for use.

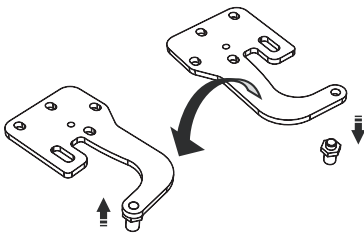

13. Just remount to the step 2, change upper hinge cover ③ to left and fix them with screws ② and then install the screw cover ①.

Finally, change screw hole cover ④ to right .

# Description of the Refrigerator

## View of the refrigerator

1. Wind channel cover in freezer
2. Freezer temperature regulator
3. Freezer shelf
4. Twist ice maker
5. Ice storage box
6. LED light
7. Fresh zone cover
8. Fresh zone drawer
9. Wind channel cover in fridge
10. Temperature controller in fridge compartment
11. Deodorizer box
12. Fridge shelf
13. Humidity control sliding block
14. hyperFresh crisper cover
15. hyperFresh crisper compartment
16. Adjustable feet
17. Freezer door
18. Upper door switch
19. Rack on upper door
20. Freezer door seal
21. Fridge door seal
22. Upper rack \*
23. Egg tray (inside)
24. Small rack \*
25. Lower door switch
26. Middle rack \*
27. Lower rack
28. Fridge door

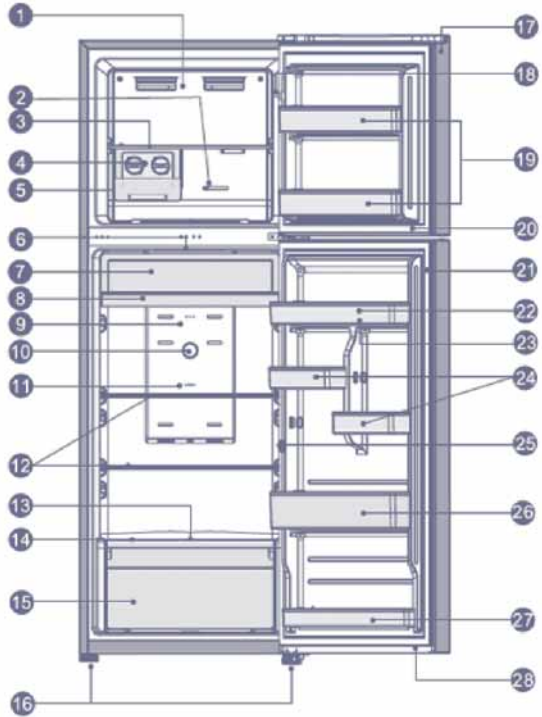

\*Depends on model

# Control panel

Use your appliance according to the following control regulations, your appliance has the corresponding functions as the control panels showed in the pictures below.

## Temperature controller in fridge compartment

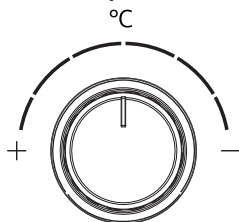

### noFrost

By adjusting the temperature controller to control the temperature of the fridge compartment, the specific operations are as follows:

- Using the fridge in normal condition, you can set the temperature controller in the middle.
- When you need the lower temperature in fridge compartment, you can turn the temperature controller to the right.
- When you need the higher temperature in fridge compartment, you can turn the temperature controller to the left.

### Important!

High ambient temperature (e.g. on hot summer days) and set the temperature control knob to the rightmost "-", the compressor may run continuously or even non-stop!

Reason: When the ambient temperature is high, the compressor must run continuously to maintain the low temperature in the appliance. So we do not advise the user to set the temperature control knob to the rightmost "-" in normal condition.

### Important!

when you rotate the temperature controller, please make sure the finger aims at the gap (for all settings), to avoid the temperature controller jammed.

As shown in figure below.

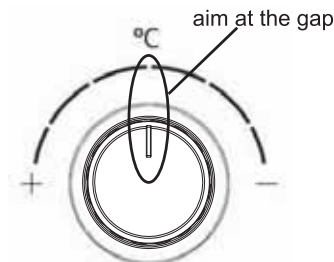

## Temperature regulator in freezer compartment

- °C +



By adjusting the temperature slider to control the temperature of the freezer compartment, the specific operations are as follows:

- Please set the temperature slider to around 1/4 from the left in normal condition.
- If you need freezing quickly or to lower the temperature in freezer compartment, please adjust the temperature slider to the left "-".
- If the temperature in freezer compartment is too low, please adjust the temperature slider to the right "+".

### Important!

We do not suggest user to set the temperature slider to the leftmost "-" in normal condition. It will increase the fridge compartment temperature and energy consumption.

## Important!

Avoid contact between food and the cover of air outlet channel. Do not block air outlet openings with food, otherwise the air circulation will be impaired, the appliance cannot operate normally.

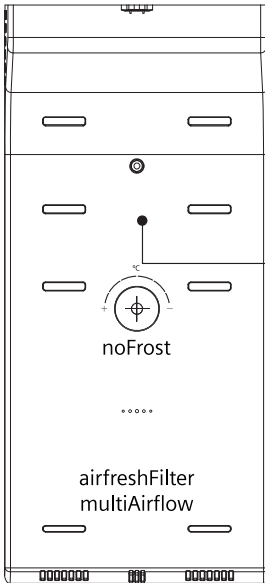

the cover of air outlet channel  
in the refrigerator compartment

---

## Using your refrigerator

Your refrigerator has the accessories as the "Description of the refrigerator" showed in general, with this part instruction you can have the right way to use them.

---

### Door rack

- It is suitable for the storage of eggs, canned liquid, bottled drinks and packed food, etc. Do not place too many heavy things in the rack.
- Small rack on lower door can be placed at different heights according to your requirements. Please take food out of the shelf before lifting vertically to reposition.

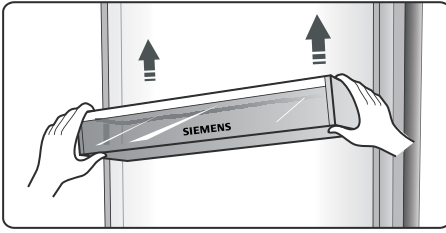

Note: There are egg trays in the upper shelf.

## Shelf in fridge compartment

- There are shelves in fridge compartment, and they can be taken out to be cleaned.

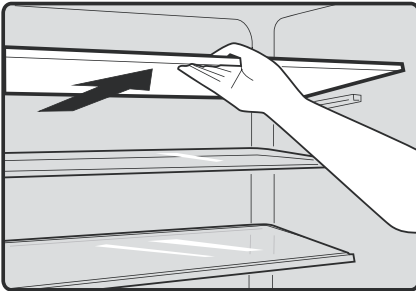

## Fresh zone drawer

- It is suitable to store food and drinks which are ready served or temporary storage of food is going to be served soon.

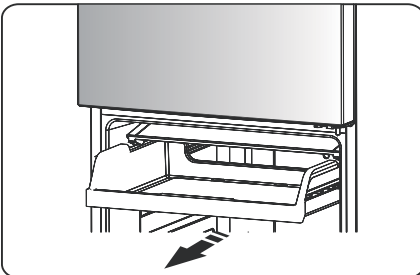

## hyperFresh crisper cover

- It is for controlling the temperature of the crisper to avoid vegetable losing moisture.

## hyperFresh crisper compartment with humidity control

- The crisper is for storing vegetables and fruits. You can adjust the humidity inside by using the sliding block.
- The sliding block on crisper cover can slide to left or right and the air hole become more or less relatively. More air hole opening means less humidity and less means more humidity.
- We recommend that you store vegetables with more humidity and fruits with less humidity.

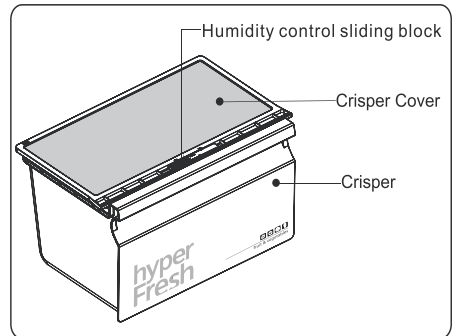

---

## Twist ice maker

Note: If the ice tray is used for the first time or has not been used for a long time, please clean it before using.

- The Twist ice maker is used to make and deposit ice cubes. You should use it as follows.

1. Pull out the Twist ice maker from the installation bracket.
2. Pour water into the ice trays and the water level shall not exceed the maximum line.

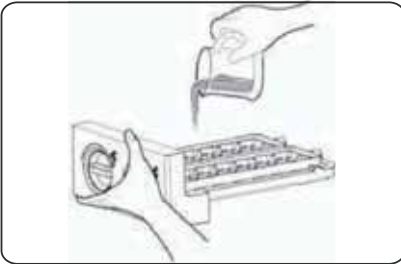

3. Place the filled ice tray back to the bracket.
4. When ice cubes formed, twist the knobs clockwise and the ice will drop into the ice box below.
5. Ice cubes can be stored in the ice box, if you need them, you can pull out the ice box and take them out.

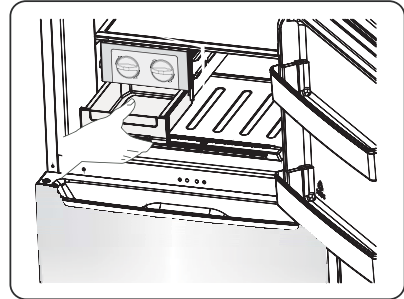

---

## Helpful hints and tips

### Energy saving tips

We recommend that you follow the tips below to save energy.

- Try to avoid keeping the door open for a long period in order to conserve energy.
- Ensure the refrigerator is away from any sources of heat (Direct sunlight, electric oven or cooker etc).

- Do not set the temperature colder unless necessary.
- Do not store warm food or evaporating liquid in the refrigerator.
- Place the refrigerator in a well ventilated, humidity free room. Please refer to the "Installing your new refrigerator" chapter.

---

## Hints for fresh food storage

- Do not place hot food directly into the fridge or freezer, the internal temperature will increase resulting in the compressor having to work harder and will consume more energy.
- Cover or wrap the food particularly if it has a strong flavor.
- Place food properly so that air can circulate freely around it.

---

## Hints for fridge

- Meats (all types) wrapped in polythene: wrap and place on the glass shelf above the vegetable drawer. Always follow food storage time and use by date suggested by manufacturers.
- Cooked food, cold dishes, etc.: They should be covered and may be placed on any shelf.
- Fruit and vegetables: They should be stored in the special drawer provided.
- Butter and cheese: Should be wrapped in airtight foil or plastic film wrap.
- Milk bottles: Should have a lid and be stored in the door racks.

---

## Hints for freezer

- When first starting-up or after a period out of use, run the refrigerator at least 2 hours before putting food in the compartment.

- Prepare food in small portions to enable it to be rapidly and completely frozen and to make it possible to subsequently thaw only the quantity required.
- Wrap up the food in aluminum foil or polyethylene food wraps which are airtight.
- Do not allow fresh unfrozen food to touch the food which is already frozen to avoid temperature rise of the latter.
- Iced products if consumed immediately after removal from the freezer compartment, will probably cause frost burns to the skin.
- It is recommended to label and date each frozen package in order to keep track of the storage time.

---

## Hints for the storage of frozen food

- Ensure that frozen food has been stored correctly by the food retailer.
- Once defrosted, food will deteriorate rapidly and should not be re-frozen. Do not exceed the storage period indicated by the food manufacturer.

---

## Switching off your refrigerator

If the refrigerator needs to be switched off for an extended period, the following steps should be taken to prevent mould on the refrigerator.

1. Remove all food.
2. Remove the power plug from the mains socket.
3. Clean and dry the interior thoroughly.
4. Ensure that all the doors are wedged open slightly to allow air to circulate.



# Cleaning and care

---

For hygienic reasons the refrigerator (including exterior and interior accessories) should be cleaned regularly at least every two months.

**Caution!** The refrigerator must not be connected to the mains during cleaning.

Danger of electrical shock!

Before cleaning, switch the refrigerator off and remove the plug from the mains socket.

---

## Exterior cleaning

To maintain good appearance of your refrigerator, you should clean it regularly.

-Wipe the control panel with a clean, soft cloth.

-Spray water onto the cleaning cloth instead of spraying directly on the surface of the refrigerator.

This helps ensure an even distribution of moisture to the surface.

-Clean the doors, handles and cabinet surfaces with a mild detergent and then wiped dry with a soft cloth.

### **Caution!**

-Do not use sharp objects as they are likely to scratch the surface.

-Do not use thinner, car detergent, abrasive cleansers or organic solvent for cleaning. They may damage the surface of the refrigerator and may cause fire.

---

## Interior cleaning

You should clean the refrigerator interior regularly.

It will be easier to clean when food stocks are low.

Wipe the inside of the refrigerator using a mild detergent with warm water using a wrung-out sponge or cloth.

Wipe completely dry before replacing the shelves and baskets.

Thoroughly dry all surfaces and removable parts.

Although this refrigerator automatically defrosts, a layer of frost may occur on the freezer compartment's interior frequently. If the frost is too thick, choose a time when the food stocks are low and proceed as follows:

1. Remove existing food and accessories baskets, unplug the refrigerator from the mains socket and leave the doors open. Ventilate the room thoroughly to accelerate the thawing process.

2. When defrosting is completed, clean your freezer as described above.

**Caution!** Don't use sharp objects to remove frost from the freezer compartment.

Only after the interior is completely dry should the refrigerator be switched back on and plugged back into the mains socket.

---

## Door seals cleaning

Take care to keep door seals clean. Sticky food and drinks can cause seals to stick to the cabinet and tear when you open the door.

Wash seal with a mild detergent and warm water.

Rinse and dry it thoroughly after cleaning.

**Caution!** Only after the door seals are completely dry that should the refrigerator be powered on.

---

## Replacing the LED light:

Warning: If the LED light cannot be replaced by the user when the LED light is damaged, contact our Service Centre for assistance.

To replace the LED light, the below steps can be followed:

1. Unplug your refrigerator.
2. Remove light cover by pushing up and out.
3. Hold the LED cover with one hand and pull it with the other hand while pressing the connector latch.
4. Replace LED light and reverse back the previous steps.

## Troubleshooting

---

If you experience a problem with your refrigerator or are concerned that the refrigerator is not functioning correctly, you can carry out some easy checking steps before calling for service, please see the below table from pages 18. You can carry out some easy checks according to this section before calling for service.

**Warning!** Do not try to repair the refrigerator yourself. If the problem persists after you have made the checking steps as mentioned below, contact a qualified electrician, authorized service centre for service if necessary.

Problem	Possible cause & Solution
Refrigerator is not working correctly	Check whether the power cord is plugged into the power outlet properly.
	Check the fuse or circuit of your power supply, replace if necessary.
	The ambient temperature is too low. Try setting the chamber temperature to colder level to solve this problem.
	It is normal that the freezer is not operating during the automatic defrost cycle, or for short time after the refrigerator is switched on to protect the compressor.
Odours from the compartments	The interior may need to be cleaned
	Some food, containers or wrapping cause odours

Problem	Possible cause & Solution
Noise from the refrigerator	<p>The sounds below are quite normal:</p> <ul style="list-style-type: none"> <li>● Compressor running noises.</li> <li>● Air movement noise from the small fan motor in the freezer compartment or other compartments.</li> <li>● Gurgling sound similar to water boiling.</li> <li>● Popping noise during automatic defrosting.</li> <li>● Clicking noise before the compressor starts.</li> </ul>
	<p>Other unusual noises are due to the reasons below and may need you to check and take action:  The refrigerator position is not in a level.  The back of refrigerator touches the wall.  Bottles or containers fallen</p>
The motor runs continuously	<p>It is normal to frequently hear the sound of the motor, it will need to run more in below circumstances:</p> <ul style="list-style-type: none"> <li>● Temperature setting is set colder than necessary</li> <li>● Large quantity of warm food has recently been stored within the refrigerator.</li> <li>● The temperature outside the appliance is too high.</li> <li>● Doors are kept open too long or too often.</li> <li>● After installing the refrigerator or it has been switched off for a long time</li> </ul>
A layer of frost occurs in the compartment	<p>Check that the air outlets are not blocked by food and ensure food is placed within the refrigerator to allow sufficient ventilation. Ensure that door is fully closed. To remove the frost, please refer to "Cleaning and care" chapter.</p>
Temperature inside is too warm	<p>You may have left the doors open too long or too frequently; or the doors are kept open by some obstacle: or the refrigerator is located with insufficient clearance at the sides, back and top</p>
Temperature inside is too cold	<p>Increase the temperature by following the "Control panel" chapter.</p>
Doors cannot be closed easily	<p>Check whether the top of the refrigerator is tilted back by 10mm to allow the doors to self close, or if something inside is preventing the doors from closing.</p>

Problem	Possible cause & Solution
Water drips on the floor	The water tank (located at the rear bottom of the cabinet) may not be properly leveled, or the draining spout (located underneath the top of the compressor depot) may not be properly positioned to direct water into this water tank, or the water spout is blocked. You may need to pull the refrigerator away from the wall to check the water tank and spout.
The light is not working	<ul style="list-style-type: none"> <li>■ The LED light may be damaged. Refer to "Replacing the LED light" in "Cleaning and care" chapter.</li> <li>■ The control system disables the light due to the door being opened too long. Close and reopen the door to reactivate the light.</li> </ul>

## Disposal of the refrigerator

It is prohibited to dispose this refrigerator as household waste.

### Packaging materials

Packaging materials with the recycle symbol are recyclable. Dispose of the packaging into a suitable waste collection container to recycle it.

### Before disposal of the refrigerator

1. Pull out the mains plug from the mains socket.
2. Cut off the power cord and discard with the mains plug

Warning! Refrigerators contain refrigerant and gases in the insulation. Refrigerant and gases must be disposed of professionally as they may cause eye injuries or ignition. Ensure that tubing of the refrigerant circuit is not damage prior to proper disposal.

	Correct Disposal of this product
	This marking indicates that this product should not be disposed with other household wastes. To prevent possible harm to the environment or human health from uncontrolled waste disposal, recycle it responsibly to promote the sustainable reuse of material resources.

# 內容

---

安全和警告資訊 .....	21	有用提示和貼士 .....	33
安裝新雪櫃 .....	24	清潔和保養 .....	35
雪櫃簡介 .....	29	排解疑難 .....	36
控制面板 .....	30	棄置雪櫃 .....	38
使用雪櫃 .....	31		

---

## 安全和警告資訊

爲了您的安全和正確的使用，在安裝和首次使用雪櫃前，請細心閱讀本用戶手冊，包括其提示和警告。

爲了避免不必要的錯誤和意外，重要的是確保所有使用雪櫃的人能熟悉其操作和安全功能。

請妥善保存這些說明書，並確保雪櫃如被移動或出售時，雪櫃和說明書同存，使任何使用雪櫃的人，會得到正確使用和安全資訊。

- 本雪櫃適用於8歲及以上兒童，但感官或心智能力及精神有障礙或缺乏經驗知識的人士，需得到負責他們安全的人監察和指引下使用此機器。  
兒童不應把玩此家電。  
兒童不應在沒有監督下進行操作。
- 保持所有包裝遠離兒童，以防止窒息的危險。



## 安全和警告資訊

- 如果你棄置家電，從插座拔走插頭，切斷連接線（盡可能接近雪櫃），並拆下門，防止兒童玩耍時遭受觸電或把自己關閉在雪櫃內。
- 如果此雪櫃，具有磁性門封條，取代舊雪櫃在門或蓋的彈簧鎖，你丟棄舊雪櫃之前，確保彈簧鎖無法使用。這將防止雪櫃成爲孩子死亡的陷阱。

### 一般安全

- 警告 - 這雪櫃只適用於家庭和類似的應用如  
 - 辦公室和其他工作環境的員工廚房區；  
- 農屋和旅館，飯店和其他住宅類型的環境中的客戶使用；  
- 旅館式環境；  
- 餐飲和類似的非零售應用
- 警告 - 不要存放爆炸性物質，如在雪櫃中裝有易燃推進劑的氣霧罐。
- 警告 - 如果電線損壞，必須由製造商，其服務代理商或專業人員更換，以避免危險。
- 警告 - 在家電外殼或內置結構，要保持通風孔暢通，以防阻礙物阻擋。

- 警告 - 切勿使用未經製造商許可的機械裝置零部件或其他除霜加速器。
- 警告 - 切勿損壞雪櫃電路。
- 警告 - 切勿在雪櫃的食物儲藏格內使用電子裝置，除非它們是由製造商推薦的類型。



### 電力安全

1. 電源線不可以延長。
2. 確保電源插頭沒有撞碎或損壞。撞碎或損壞的電源插頭可能會過熱並導致火災。
3. 確保兒童不可以接觸該雪櫃的電源插頭。
4. 切勿拉主電線。
5. 如果電源線插座鬆動，切勿插入電源插頭，會有觸電或火災的危險。
6. 沒有室內照明燈蓋，你不應操作雪櫃。
7. 冰箱適用於單相交流電源  
220~240V/50Hz。

# 日常使用

- 切勿在雪櫃內儲存易燃氣體或液體，防止爆炸的風險。
- 切勿在雪櫃使用任何電子電器（如電動冰淇淋機，攪拌機等）。
- 從電源插座拔出插頭，不要拉電線。
- 切勿將熱件接近這個雪櫃的塑料部件。
- 切勿在後壁的空氣出口放置食物產品。
- 按照食品製造商的說明，儲存預先包裝的冷凍食品。
- 必須嚴格遵守雪櫃製造商的儲存建議。請參考儲存相關指引。
- 切勿將碳酸或碳酸飲料放入冷凍室，因為它會在容器製造壓力，這可能會導致爆炸，導致損壞雪櫃。
- 如果直接從冷凍室取出冷凍食物，可能會導致霜凍灼傷。
- 切勿讓陽光直射雪櫃。
- 保持燃燒蠟燭，燈具和其他明火等物品遠離雪櫃，否則會令雪櫃著火。
- 按照本說明書介紹，雪櫃適用於家庭保存食品或飲料。雪櫃的重量非常重，搬運時要十分小心。
- 切勿用濕手從冷凍室取出或接觸物品，因為這可能會導致皮膚擦傷或霜凍/冰凍燒傷。
- 切勿倚靠雪櫃的底座，抽屜和櫃門等作站立或借力用。
- 冷凍食品一旦被解凍，不能再冷凍。
- 切勿食用直接從冰箱取出的冰塊或冰棍，因為這可能會導致嘴和嘴唇凍傷。
- 爲了避免物品掉落，造成人身傷害或雪櫃損壞，切勿超載櫃門架，或把過多的食物放入保鮮抽屜。

## 小心！ 保養和清潔

- 維修前，關掉雪櫃，並從電源插座拔掉插頭截斷電源。
- 切勿使用金屬物品，蒸汽清洗機，香精油，有機溶劑或磨蝕性清潔劑清潔雪櫃。
- 切勿使用尖銳物體爲雪櫃除霜。請使用塑料刮板。

## 安裝重要！

- 按照本手冊中的指示，小心連接電力。
- 拆開雪櫃包裝並檢查是否有損壞。如雪櫃已損壞，不要連接電源。請立即向你購買的商店報告有關的損壞。在這種情況下請保留包裝。

- 接駁此雪櫃前最好等待最少 4 小時，讓油回流到壓縮器。
- 在電器周圍保持足夠的空氣流通，否則會導致過熱。為了達到足夠的通風，請遵循相關的安裝指引。
- 產品背面盡可能不靠近牆壁，避免接觸或貼溫暖的部件（壓縮機，冷凝器），以防止火災的危險，請遵守相關的安裝說明。
- 該雪櫃不應放置靠近散熱器或爐具。
- 安裝雪櫃後，確保容易接觸電源插頭。

## 服務

- 電器如需要維修都必須由合格的電工或合資格人士進行。
- 本產品必須經授權的服務中心提供服務，必須使用原廠配件，否則保養會失效。

## 安裝新雪櫃

首次使用本產品前，你應該了解以下提示。

## 電器通風系統

 為了提高冷卻系統的效率和節省能源，必需保持電器周圍有良好的散熱通風系統。因此，雪櫃周圍應有足夠的空間。

建議：建議從背面到牆壁至少留有 75 毫米的空間，頂部至少 100 毫米，從側面至牆壁最少 100 毫米，並在前面預留空間，讓櫃門可 135° 打開。如以下的圖表。

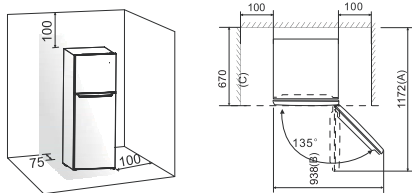

注意：

此雪櫃運作良好，氣候級別從 SN 到 T 顯示於以下圖表。

如果溫度長時間停留高於或低於指定範圍，可能無法正常運作。

氣候級別	環境溫度
SN	+10°C to +32°C
N	+16°C to +32°C
ST	+16°C to +38°C
T	+16°C to +43°C



- 雪櫃放置在乾燥的地方，避免高濕度。
- 請將雪櫃遠離直射陽光或霜凍。把雪櫃放置遠離熱源，如火爐，火焰或發熱器。

## 平放雪櫃

為保持雪櫃的下部後方的空氣流通，底部機腳可能需要調整。

可以用手或使用合適的扳手調整它們。

為了讓大門自動關閉，頂部向後傾斜大約 10 毫米。

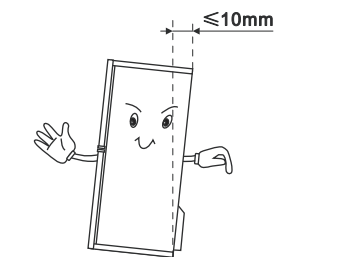



## 轉換櫃門方向

如果安裝地點需要，櫃門打開方向是可以改變的，可從右門鉸（原廠設定）更改至左門鉸。

警告！當改變櫃門打開的方向，電器不應接駁電源。確保從電源插座拔掉插頭。

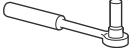
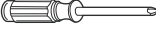
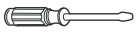
## 你需要的工具

		
8mm socket wrench	Cross-shaped screwdriver	
		
Thin-blade screwdriver	Monkey wrench	8mm wrench

注意：首先把雪櫃背部臥放，讓你接觸底部，你應把雪櫃放置在軟發泡膠包裝或類似物品上，防止雪櫃背板損壞。要反轉櫃門，請依照以下步驟。

1. 豎直放置冰箱。打開櫃門取出所有門架（避免櫃架損壞），然後關門。

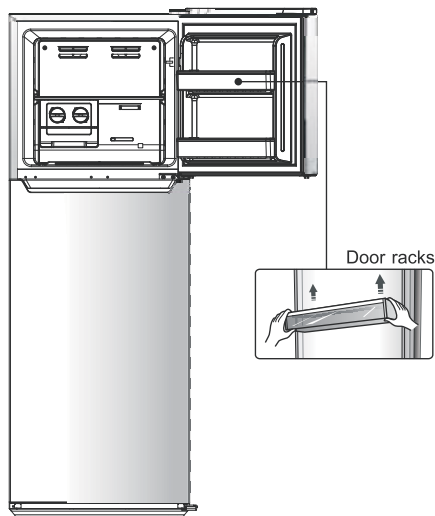

2. 豎立雪櫃，先拆下螺絲蓋①和鬆開的螺絲釘②，並扭開在雪櫃右上角的上部門鉸組件③，並用油灰刀或薄螺絲刀，撬開在雪櫃的螺絲孔蓋④。

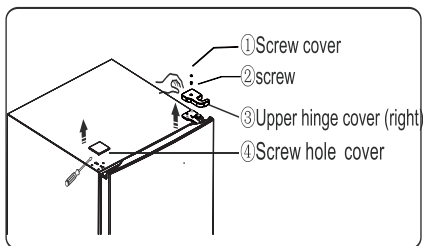

3. 扭開固定右上門鉸組件部分②的螺絲釘①。提起上門，並把它放在墊子上，以防止刮花。

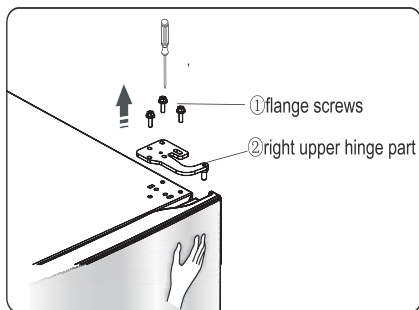

注意：在步驟 3 請用手握住上門，防止門跌下。

4. 拆下上部的門，把它放在一個平滑的表面，其面板向上。鬆開的螺絲②，分離部件①，然後用螺絲②安裝部件①到左側。

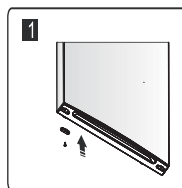
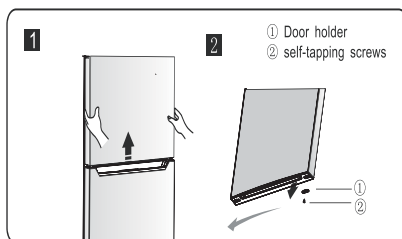

5. 鬆開用來固定中間門鉸的螺絲，和取下中間門鉸。然後移走下門。

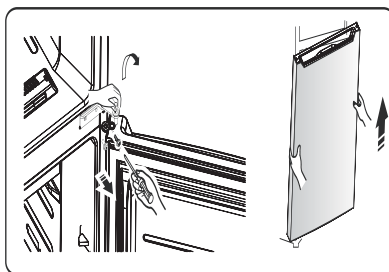

6. 把下部的門放置在一個平滑的表面，其面板向上。鬆開螺絲釘②，分開部件①。然後安裝部件①和螺絲釘②至左側適當位置。

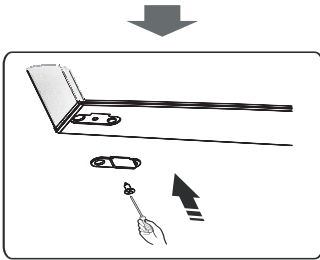
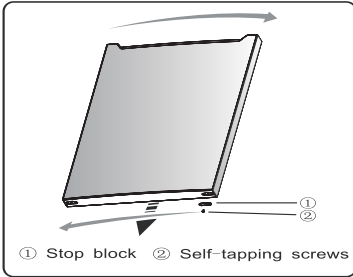

7. 中間蓋板上的螺絲孔蓋從左更改至右（如圖所示）。

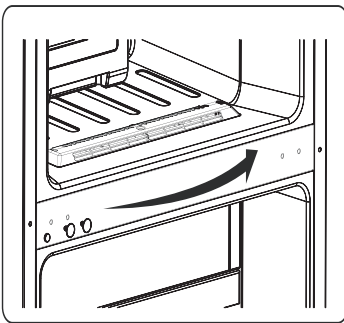

8. 將雪櫃平放，移走部件③，然後鬆開螺絲釘④，移走部件②和部件①。

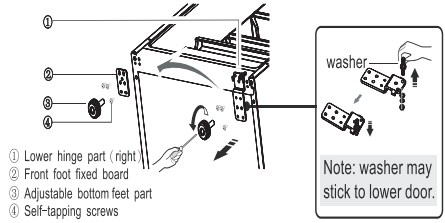

9. 擰出較低的門鉸組件，將其更改至近孔位，然後扭緊和安裝墊圈。

10. 重回到步驟 8，更改部件①至左和部件②至右，然後用螺絲釘④固定。最後安裝部件③。

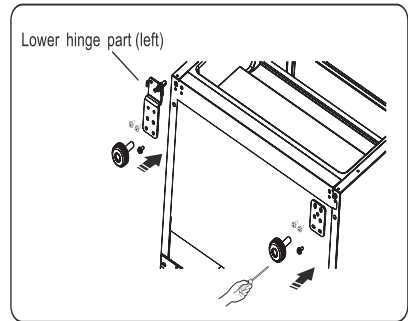

11. 移動下門並調校其位置，對齊較低的孔位和上門鉸軸。轉動中間門鉸組件 180°，更改軸上墊圈至上側，調校中間鉸到適當的位置，然後安裝。

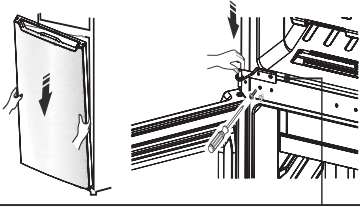

12. 擰出上門鉸組件，反轉上部門鉸組件固定在其軸上。然後，將它放置一邊使用。

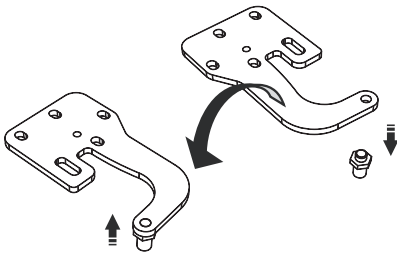

13. 重回步驟 2，上門鉸組件③更改至左，用螺絲釘②固定它們，然後安裝螺絲蓋①。最後，更改螺絲孔蓋④至右。

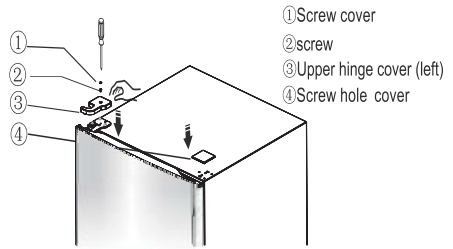

14. 打開上門，安裝門架，然後關閉好。

# 雪櫃簡介

1. 冷凍室風道蓋
2. 冷凍室溫度調節器
3. 冷凍室層架
4. 旋轉製冰盒
5. 儲冰盒
6. LED燈
7. Fresh zone 保鮮格蓋
8. Fresh zone 保鮮格
9. 冷藏室風道蓋
10. 冷藏室溫度調節器
11. 空氣過濾網
12. 冷藏室層架
13. 濕度控制滑塊
14. hyperFresh 蔬果保鮮格蓋
15. hyperFresh 蔬果保鮮格抽屜
16. 可調校櫃腳
17. 冷凍室櫃門
18. 上門開關
19. 冷凍室門架
20. 冷凍室櫃門封條
21. 冷藏室櫃門封條
22. 冷藏室門架 \*
23. 蛋格(裡面)
24. 冷藏室門細架 \*
25. 下門開關
26. 冷藏室門架 \*
27. 冷藏室門架
28. 冷藏室櫃門

雪櫃示意圖

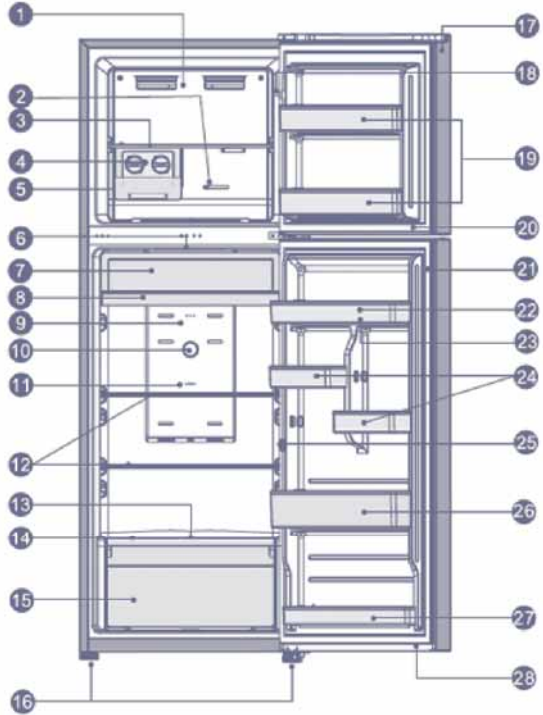

\*視乎型號

## 控制面板

根據以下控制規則使用雪櫃，你的雪櫃有相關功能，在控制面板顯示如下圖。

### 冷藏室內的溫度調節器

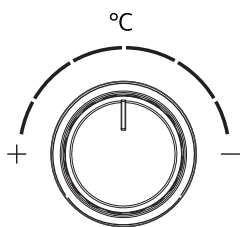

## noFrost

- 一般使用情況下請設置溫度調節器在中間的檔位。
- 如果需要更低的冷藏室溫度，請往右旋轉調節溫度調節器。
- 如果無需過低的冷藏室溫度，請往左旋轉調節溫度調節器。

### 重要！

在高溫環境下(例如在炎熱的夏天)和溫度調節器設在較冷設定，會可能導致壓縮機不斷運行。

因此，我們不建議用戶在正常情況下，溫度控制旋鈕設在最右側檔位上。

原因：當環境溫度高時，壓縮機必須不斷運行，以保持雪櫃內溫度。

### 重要！

調節冷藏室溫度調節器時，請注意將旋鈕指針對準缺口(針對所有檔位)，避免指針卡在弧線上，如下圖示意：

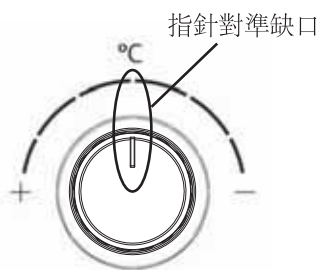

### 冷凍室的溫度調節滑塊

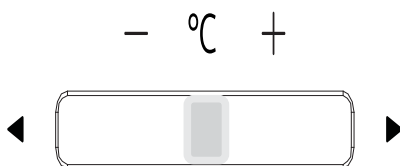

- 一般情況下請設置冷凍室溫度調節滑塊在距離左方1/4位置附近。
- 若需要冷凍室快速製冷或更低溫度，溫度調節滑塊請往左方“-”設置。
- 若冷凍室溫度太低，溫度調節滑塊請往右方“+”設置。

### 重要！

我們不建議用戶在正常情況下把溫度調節滑塊設在最左方“-”。因這將可能導致冷藏室溫度過高，並且耗電量增加。

# 重要！

避免食物與風道蓋的接觸。 不要用食物擋住風道出口，否則空氣流通將受影響，影響雪櫃正常運行。

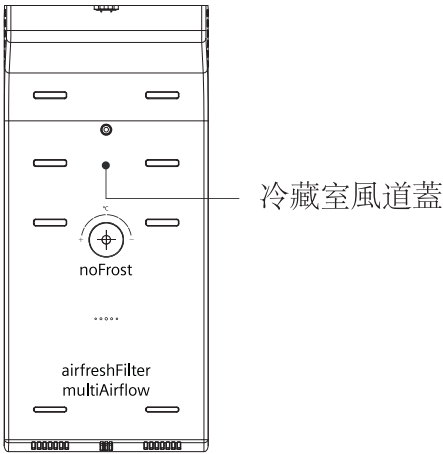

---

## 使用雪櫃

在說明書內的 " 雪櫃簡介 " 會顯示一般雪櫃配件，讓你可以正確使用它們。

### 門架

■它適用於儲存雞蛋，罐裝液體，瓶裝飲料和包裝食品等，不要在櫃架中放置太多沉重的東西。

下層櫃門的細架可根據你的要求放置不同的高度。請從貨架取出食品後再垂直升降重新定位。

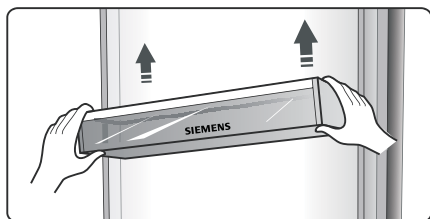

注意：在上層層架有蛋格。

## 冷藏室的層架

- 冷藏室內有層架，並且可以將它們取出清洗。

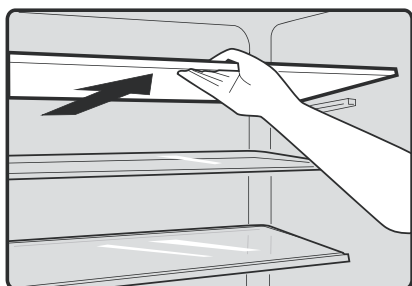

## Fresh zone 保鮮格

- 適合存放可食用食物和飲料或暫時貯存即將食用的食物。

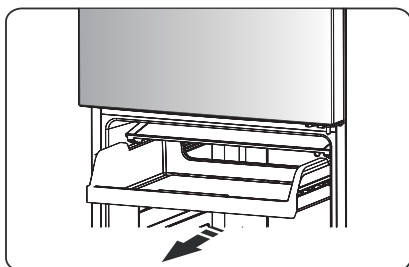

## hyperFresh 蔬果保鮮格蓋

- 它是用於控制保鮮室的溫度和避免蔬菜失去水分。

## hyperFresh 蔬果保鮮格 連濕度控制

- 保鮮格適用儲存蔬菜和水果。可以使用滑動開關調節內部濕度。
- 保鮮格蓋上的滑塊開關可以向左或右滑動，以控制空氣孔開合。空氣孔打開越多代表濕度降低，關閉空氣孔代表濕度提高。
- 建議用高濕度儲存蔬菜，低濕度儲存水果。

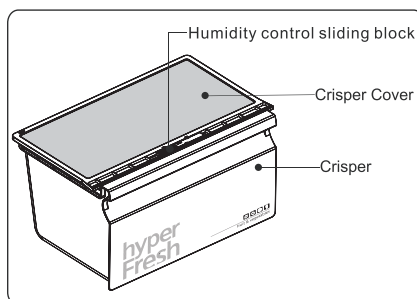



## 旋轉製冰盒

注意：如果首次使用製冰格或長時間沒有使用，請在使用前清潔它。

### ■ 扭動冰盤是用來製造和存放冰塊。

使用如下：

1. 從安裝支架拉出旋轉製冰盒。
2. 將水倒入製冰盒並水位不得超過最高線。

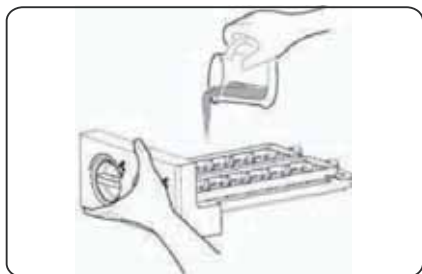

3. 將填滿了的製冰盤放回支架。
4. 當冰塊形成，順時針扭動旋鈕和冰塊將跌在下面的冰盒。
5. 冰塊可以儲存在冰盒內，如果需要冰塊，可以拉出冰盒取出。

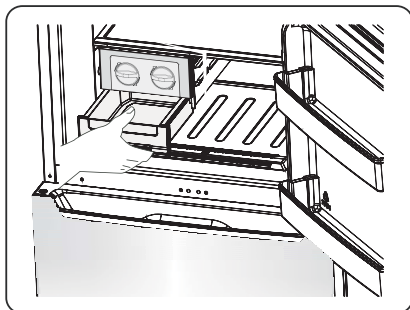

## 有用提示和貼士

### 節約能源貼士

我們建議你按照下面的提示，以節省能源。

- 盡量避免長時間敞開櫃門，以節約能源。
- 確保雪櫃遠離任何發熱來源（陽光直射，電焗爐或電磁爐等）。
- 如非必要，請不要將溫度設置在更冷的位置。
- 在雪櫃內切勿儲存溫暖的食物或蒸發的液體。
- 將雪櫃安裝在通風良好的地方，避免濕度太高。請參閱安裝新雪櫃的章節。
- 圖片顯示正確的抽屜組合，保鮮盒和層架，切勿調整組合，因為這設計是最有效節能的配置。

## 新鮮食品冷藏提示

- 切勿把熱的食物直接放入冷藏室或冷凍室，因內部溫度上升，會導致壓縮器不斷地運行，並會消耗更多的能量。
- 應該覆蓋或包裹食物，特別是味道強烈的食物。
- 將食物適當地擺放，使周圍空氣能夠流通。

## 冷藏室提示

- 用食物包裝膠包裹肉類（所有類型）：包裝好後請放在蔬菜保鮮格上或玻璃層架上面。時常遵照製造商建議的食物儲存時間和使用日期。
- 熟食，涼菜等：它們應被包蓋，並且可以放置在任何層架。
- 水果和蔬菜：它們應儲存在特別提供的抽屜內。
- 牛油和奶酪：應用密封鋁箔或塑料薄膜包裝。
- 奶瓶：應具有蓋子和儲存在門架。

## 冷凍室提示

- 當首次啓動時或一段時間停止使用後，讓雪櫃先運行至少 2 小時，才把食物放入櫃內。

- 食品分爲小份，令其能夠迅速和完全冷凍。
- 用鋁箔，食物包裝膠密封包裹食物。
- 切勿讓新鮮解凍食物碰到已經凍結的食物，以避免後者的溫度提升。
- 如果從冷凍室取出後即時食用冰凍產品，將可能導致皮膚霜凍灼傷。
- 建議在各冷凍包裝上標貼日期，用以保持儲存時間紀錄。

## 儲存冷凍食品的提示

- 確保食品零售商正確保存冷凍食品。
- 當解凍後，食品將迅速腐化，不應重新再冷凍。切勿貯存超過製造商指示的食物貯存期。

## 關掉雪櫃

如果需要長時間關掉雪櫃，應採取以下步驟防止雪櫃發霉。

1. 取出所有的食物。
2. 從電源插座拔掉插頭。
3. 清潔和徹底抹乾櫃內。
4. 確保稍微打開所有櫃門讓空氣流通。

## 清潔和保養

在衛生方面，雪櫃（包括外部和內部配件）應定期至少每兩個月清洗。

注意！雪櫃不應在清洗過程中接駁電源。這存有觸電危險！

清潔前關掉雪櫃，並從電源插座拔掉插頭。

### 外面清洗

爲了保持雪櫃外觀優美，你應該定期清潔雪櫃。

- 用乾淨的軟布擦拭控制面板。
- 在清潔布上噴灑水，代替直接在雪櫃的表面噴灑。這有助確保水分均勻分佈在櫃面上。
- 用溫和稀釋的清潔劑清潔門，手柄和雪櫃表面，然後用軟布擦乾。

### 注意！

- 切勿使用尖利的物品，因爲它們可能會劃花表面。
- 切勿使用稀釋劑，汽車洗滌劑，研磨清潔劑或有機溶劑進行清潔。他們可能會損壞雪櫃的表面，也可能引起火災。

### 內部清洗

你應該定期清潔雪櫃內部。

當食物存量低，會更容易清洗。

用溫水或溫和稀釋的清潔劑，擦拭雪櫃內部，然後用擰乾的海綿或布加溫水清潔。放回層架和籃子前，要完全抹乾。

徹底抹乾所有表面和可移動的部件。

雖然這雪櫃可自動除霜，但冷凍室的內部有機會出現一層霜。如果霜雪太厚，選擇一個食物存量低的時間，並依照如下操作：

1. 取出現有的食品及雪櫃配件，拔掉電源，並把櫃門敞開。徹底保持房間通風，加速解凍過程。
2. 當除霜完成後，依照上述程序清理你的雪櫃。

### 注意！

切勿使用尖利的物品，在冷凍室除霜。當內部完全乾透後，重啓雪櫃和把插頭插回電源插座。

### 清潔櫃門封條

小心保持櫃門封條清潔。粘的食品和飲料可以導致封條粘到櫃殼，當你打開門時封條可能會撕裂。

用溫和清潔劑和溫水清洗封條。

清潔後，沖洗和徹底抹乾。

注意！只有在櫃門封條完全抹乾後，才開啟雪櫃。

### 更換LED燈：

警告：如用戶不能自行更換LED燈，如果LED燈損壞，請聯繫我們服務中心尋求協助。

更換LED燈，可依照以下步驟：

1. 拔掉雪櫃插頭。
2. 向上按和拉出而取下燈罩。
3. 用一隻手握住LED燈蓋，用另一隻手按下連接器門鎖時拉出。
4. 更換LED燈和倒轉之前步驟裝上燈罩。

---

## 排解疑難

如果你遇到雪櫃問題，或擔心雪櫃不正常運作，你可以在致電服務中心之前進行一些簡單的檢查，請參見下文。電召服務之前，你可以根據本章節進行一些簡單的檢查。

**警告！**不要嘗試自行維修設備。如果你已作出下述檢查而問題仍然存在，請聯繫我們的服務中心查詢或安排維修。

問題	可能的原因和解決方法
雪櫃不能正常地運作	檢查電源線插頭是否插入電源插座。
	檢查電源保險絲或電路，如果有需要請更換。
	周圍溫度太低，嘗試降低冷藏室溫度去解決這個問題。
	在自動除霜程序中，雪櫃可能暫停操作，或在雪櫃啟動後短時間停止運作來保護壓縮器。
室內傳出臭味	可能需要清潔內部
	有些食物，容器或包裝引發氣味。

問題	可能的原因和解決方法
雪櫃傳出噪音	<p>以下聲音都很正常。</p> <ul style="list-style-type: none"> <li>■ 壓縮器發出噪音。</li> <li>■ 在冷凍或其他層室的細風扇摩打傳出空氣流動噪音。</li> <li>■ 淙淙聲聽起來類似水的沸騰聲。</li> <li>■ 在自動除霜發出啪聲噪音。</li> <li>■ 壓縮機啟動前的點擊噪音。</li> </ul> <p>因其他以下原因，你可以檢查並採取行動：</p> <p>雪櫃位置不平。</p> <p>雪櫃背面觸碰牆壁。</p> <p>樽瓶或容器跌下</p>
壓縮機不斷運作	<p>經常聽到壓縮機聲是正常的，在以下情況壓縮機會需要運行更多：</p> <ul style="list-style-type: none"> <li>■ 溫度設定比實際需要更冷</li> <li>■ 近來在雪櫃內儲存大量暖熱食物。</li> <li>■ 雪櫃外面溫度太高。</li> <li>■ 櫃門保持長時間或過於頻繁打開。</li> <li>■ 在安裝雪櫃後或已長時間關閉後重新啟動。</li> </ul>
雪櫃內部出現一層霜雪	<p>檢查空氣出口沒有被食物阻塞和確保雪櫃內食物擺放有足夠通風。確保櫃門完全關閉。要除霜，請參閱清潔和保養章節。</p>
雪櫃內溫度太暖	<p>你可能打開櫃門時間過長或太頻密；或者雪櫃門被某些阻礙物令其打開，或雪櫃的側面、背面和頂部散熱空間不足。</p>
雪櫃內溫度太冷	<p>依照“控制面板”章節增加溫度。</p>
櫃門不能容易關閉	<p>檢查雪櫃頂部是否向後昂起 10 毫米，讓櫃門可以自行關閉，或內裏有些物品阻礙櫃門關門。</p>

問題	可能的原因和解決方法
<p>地上有水滴</p>	<p>水盤（位於機殼的後面底部）可能沒有好好放平，或排水口（位於壓縮機倉庫的頂部下面）可能沒有適當地放置讓水流入盤內，或噴水口被堵塞了。你可能需要拉開雪櫃遠離牆壁檢查水盤和排水口。</p>
<p>燈不能亮著</p>	<ul style="list-style-type: none"> <li>■ LED 燈可能損壞了。請參閱更換 LED 燈的“清潔和保養”章節。</li> <li>■ 因打開櫃門太長時間，控制系統令燈熄滅，關閉和重開櫃門令燈重亮。</li> </ul>

## 棄置雪櫃

嚴禁將本電器視為家庭垃圾棄置。

### 包裝材料

包裝材料附有回收標誌是可回收的。棄置包裝物料到一個合適的垃圾收集容器以作回收再用。

### 棄置雪櫃前

1. 從電源插座拉出電源插頭。
2. 切斷電源線，並與主插頭一同棄置。

警告！雪櫃包含製冷劑和壓縮氣體。製冷劑和氣體必須經過專業處理，因為它們可能會導致眼睛受傷和灼傷皮膚。

妥善處置前，確保製冷劑的喉管沒有損毀。

	正確處置產品提示
	<p>此標誌代表這產品不應與其他家庭垃圾一同處理。為了避免因受控制的廢物棄置而對環境和人類造成傷害，請負責任地回收它，促進物料資源持續再用。</p>



**BSH Hausgeräte GmbH**  
Carl-Wery-Str. 34  
81739 München

GERMANY

Manufactured by BSH Hausgeräte GmbH under Trademark License of Siemens AG  
MANUFACTURED BY BSH HAUSGERAETE GMBH UNDER TRADEMARK LICENSE OF SIEMENS AG

[siemens-home.bsh-group.com](http://siemens-home.bsh-group.com)



8001113197 (0008) en, zh-hk