

SIEMENS



CT636LES6W

全自动咖啡机

siemens-home.bsh-group.cn/welcome

zh 使用说明书
en Instruction manual

使用产品前请仔细阅读本使用说明书, 并请妥善保管

A

供货范围 (参见第 6 页)
Included in delivery (see page 29)

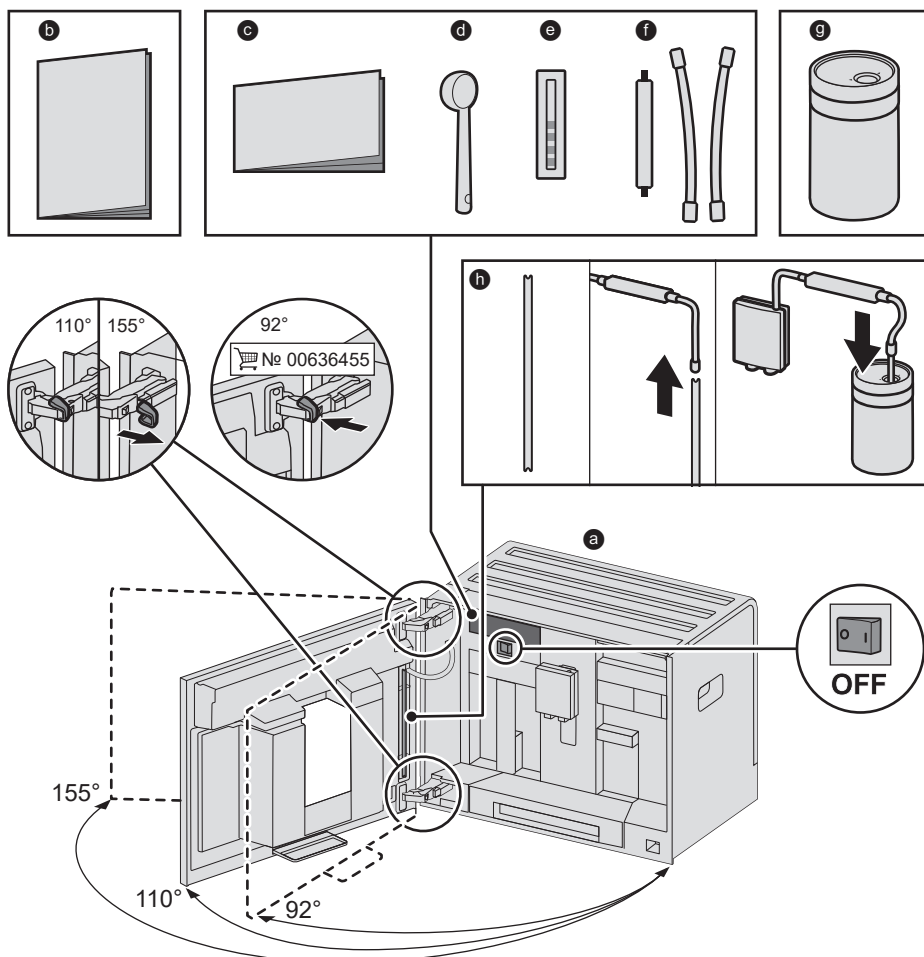

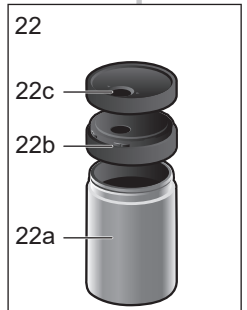
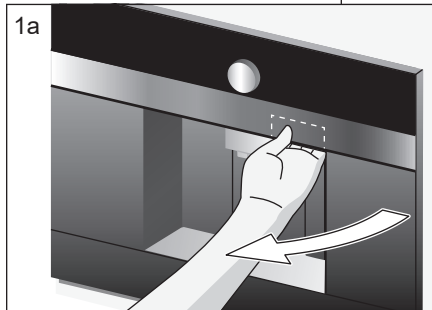
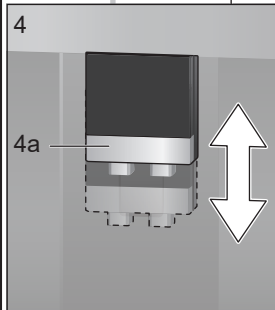
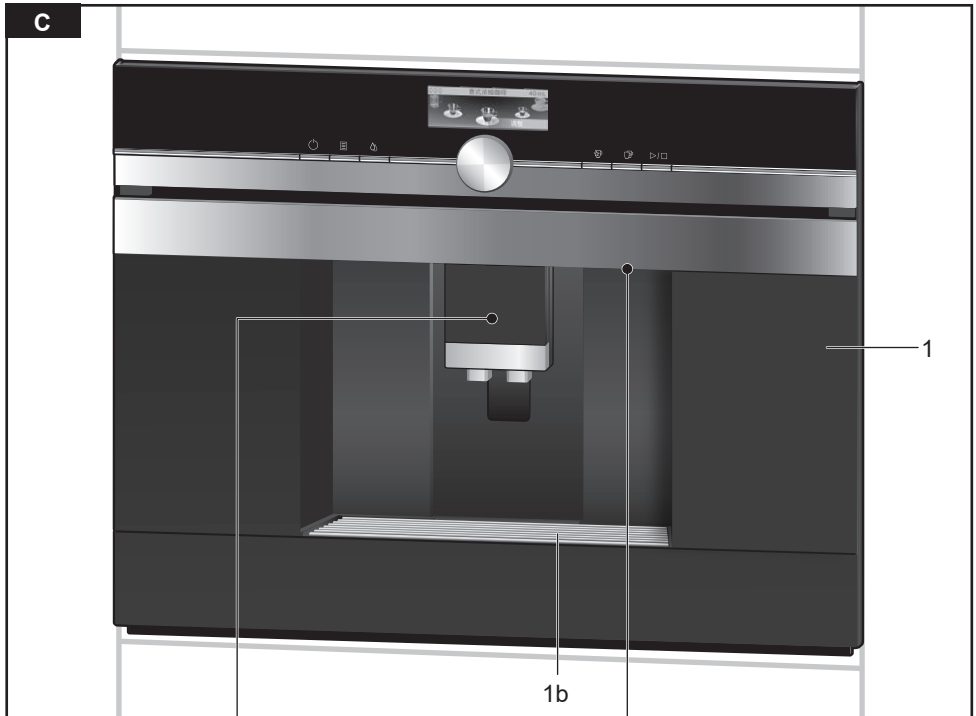
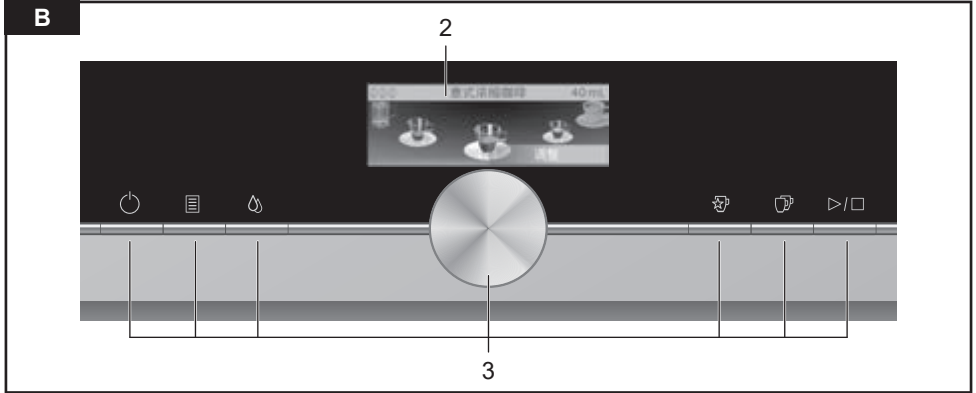

D

19
19a

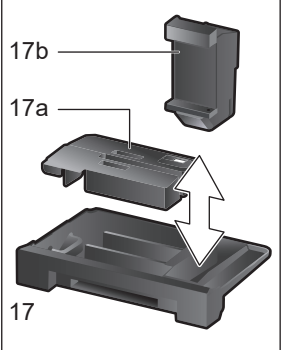
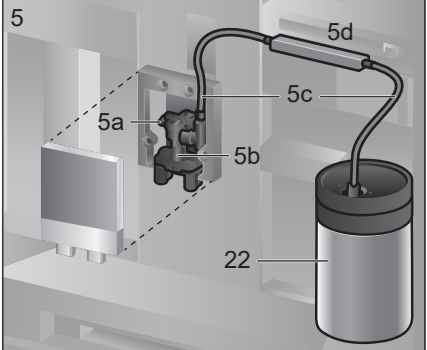
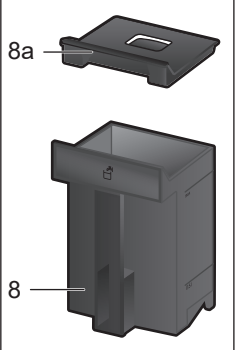
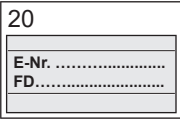
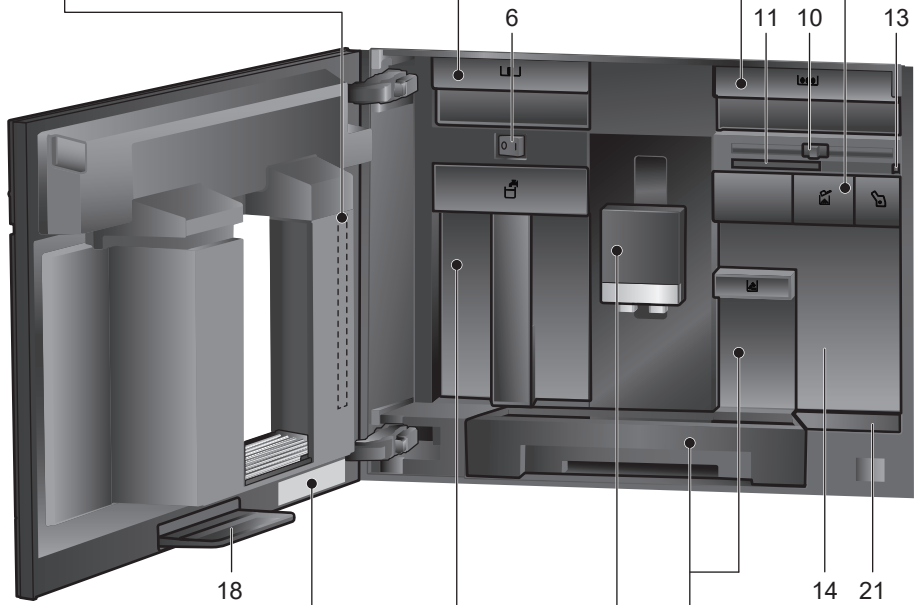
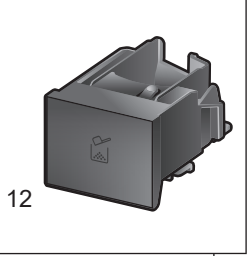
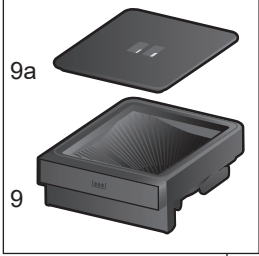
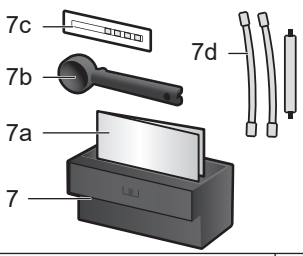

E

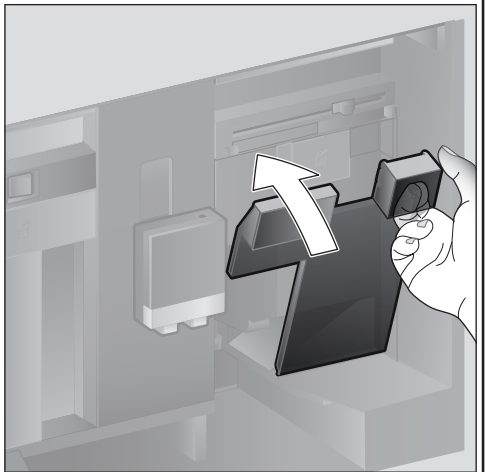
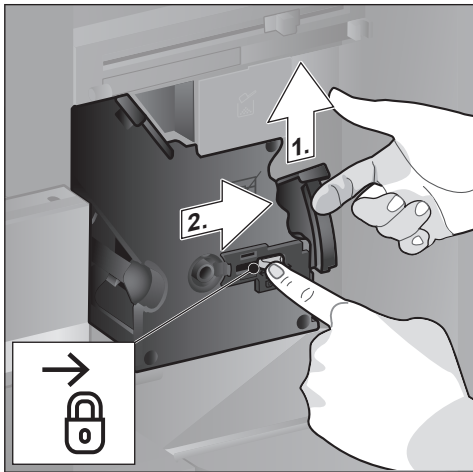
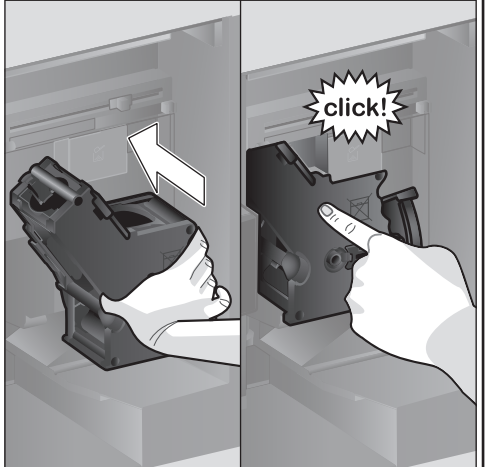
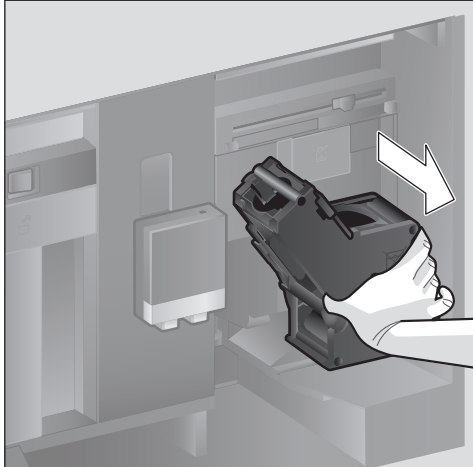
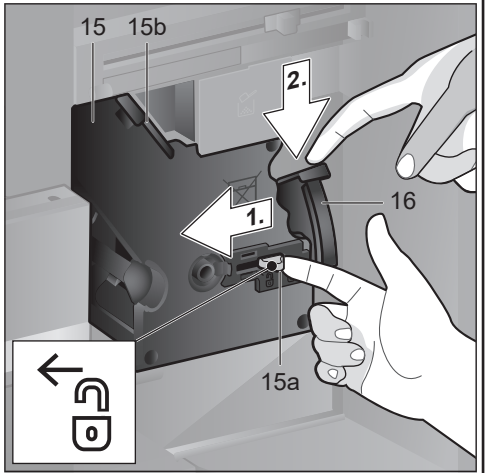
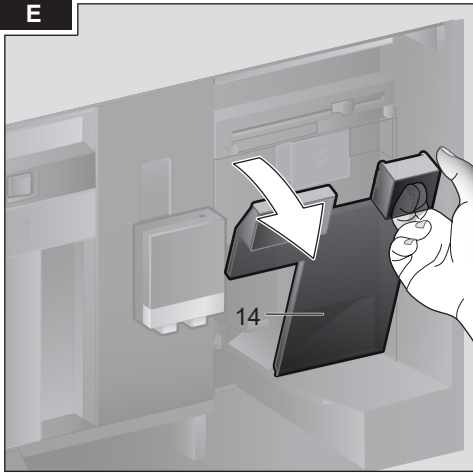

内容

供货范围 (使用专用).....	6
感谢您.....	7
使用范围.....	8
重要安全须知.....	8
概览.....	10
操作控件.....	10
启用.....	11
显示屏.....	12
饮料制备.....	12
使用咖啡豆制备.....	14
制备添加牛奶的咖啡.....	14
使用预磨咖啡粉制备.....	15
冲制热水.....	15
个性化饮料.....	15
同时制备两份.....	16
设置研磨度.....	16
儿童安全锁.....	17
菜单.....	17
Home Connect.....	18
维护和日常清洁.....	21
保养程序.....	23
节能秘诀.....	25
防冻保护.....	25
存放附件.....	25
附件.....	25
废弃物处理.....	25
保修.....	25
简单故障排除.....	26
技术数据.....	28

供货范围 (使用专用)

(参见图 A)

- a 全自动咖啡机
- b 使用说明书
- c 快速指南
- d 咖啡勺
- e 水硬度检测试纸
- f 配有牛奶软管 (套)
- g 牛奶盒
- h 牛奶软管

感谢您...

...购买本台全自动咖啡机！您获得了一台高质量、现代化的厨房设备。以创新科技研发而成，功能丰富而又操作简单。它可以为您迅速冲泡出一杯杯香醇可口的热饮，无论是浓烈的意式浓缩咖啡、绵密的卡布其诺、柔顺的拿铁玛奇朵或牛奶咖啡，还是传统的咖啡。同时，本机还提供了许多附加功能，让您依据个人喜好冲泡个性化咖啡。

为确保您能可靠和安全地使用此全自动咖啡机的所有操作和功能，请您务必熟悉本机所提供的各项组件、功能、显示以及操作控件。此说明书将帮助您了解本咖啡机。请花些时间阅读使用说明书再开机。

主要技术参数：

额定电压范围：220V-240V~

额定频率范围：50-60Hz

额定功率：1600W

原产地：斯洛文尼亚

总经销商：博西家用电器（中国）有限公司

地址：南京市中山路129号中南国际大厦

20、21楼

执行标准：

GB 4706.1-2005

家用和类似用途电器的安全 第1部分：通用要求

GB 4706.19-2008

家用和类似用途电器的安全 液体加热器的特殊要求

GB 4706.30-2008

家用和类似用途电器的安全 厨房机械的特殊要求

使用本说明书

您可以在本说明书的第一页查找咖啡机构造图与标示数字，并可反复地参照。

例如：酿造装置（15）

显示屏和符号也同样在本手册中显示。所以，您可以认出在机器上或说明书上所显示相关的文字或符号。

显示屏上的显示：“意式浓缩咖啡”

显示屏上的按键和操作控件：[> / □]

另有一份快速指南，帮助您迅速查找到最重要的功能。快速指南收在机器的附件收放处。

全国统一客户服务热线：4008899999

服务邮箱：careline.china@bshg.com

使用范围

打开包装后检查电器。出现运输损坏时不得进行连接。

本设备规定只可用于私人家庭和家用环境。

仅限在室温及海拔 2000 米以下的室内使用机器。

重要安全须知

请仔细阅读使用说明书，并保存本说明书以备以后使用！机器转让给他人使用时，请将本说明书一并转让。

凡年满 8 岁的儿童，身体、感官或智力有缺陷的人士以及缺乏相关经验和知识的人士，应在负责安全使用机器人员的监督或指导下，了解使用机器可能带来的危险后，方能使用本机。本机非供儿童使用，请勿让 8 岁以下的儿童靠近本机和连接电线。严禁儿童将本机用于嬉戏。年满 8 岁的儿童必须在监督下，方能对本机进行清洁或保养。

⚠ 警告 **有电击危险！**

- 本机仅能通过按规定的接地插座与带交流电的供电系统相连接。请您确保，建筑内已按规定安装电气接地系统。
- 仅限按照铭牌上的说明连接和操作本机。
- 电线和机器必须完好无损方可使用。
- 机器修理事宜仅由我们的客户服务进行，才能避免危险发生。
- 若本机的电源线损坏，请务必更换由我们客户服务所提供的特定电源连接线。
- 请勿将机器或电线浸泡在水中。
- 故障发生时，请立即拔下电源插头或关闭电源电压。
- 不得在电器插头连接处溢出任何液体。
- 应遵守说明书中有关清洁的特殊注意事项。

⚠ 警告 **磁性引起的危险！**

本机含有永久磁铁，会对心脏起搏器或胰岛素泵等电子植入物造成影响。请本身载有电子植入物的人距机器前至少保持 10 厘米以上的距离。

⚠ 警告 **窒息危险！**

- 请勿让儿童用包装材料玩耍。
- 请妥善保管小零件，以避免吞食。

⚠ 警告 **受伤危险！**

- 请勿将手伸入研磨机内。
- 关闭门时，请注意手指。
- 不当使用本机可能会导致受伤。

⚠ 警告 **烧伤危险！**

- 饮料出口很烫。使用后应先让其冷却，然后才能触摸。
- 使用过后，电器表面会持续发热一段时间。
- 刚制备好的饮料可能十分烫。如有必要，可以将其稍微冷却。

⚠ 警告 **烫伤危险 (Home Connect)！**

无人看守的情况下进行远程开启时，若有人在饮料流出期间触摸咖啡出口下方，可能造成第三方烫伤的危险。因此，在无人看守的情况下进行远程开启时，请确保不会对他人，尤其是儿童，或者对财物造成危险。

注意：如果电源软线损坏，为了避免危险，必须由制造商、其维修部或类似部门的专业人员更换。

概览

(参见图 B 至 E)

- 1 机门
 - a 隐藏式把手 (开启机门)
 - b 搁架
- 2 显示屏
- 3 操作控件
- 4 出口系统 (咖啡、牛奶、热水), 可调高度
 - a 防尘盖
- 5 加奶系统
 - a 锁杆
 - b 饮料出口 (顶部、底部)
 - c 导奶管 (2 套)
 - d 连接件, 金属 (用于磁架)
- 6 电源开关 [O/I] (电源)
- 7 附件收放处
(用于快速指南和附件)
 - a 快速指南
 - b 咖啡勺
 - c 水硬度检测试纸
 - d 配有牛奶软管 (套装)
- 8 分离式水箱
 - a 水箱盖
- 9 分离式咖啡豆箱
 - a 咖啡豆箱盖
- 10 咖啡豆研磨细度设置滑块
- 11 磁架 (用于连接件)
- 12 分离式粉剂抽屉
(咖啡粉/清洁片剂)
- 13 固定架 (用于导奶管)
- 14 保护盖 (用于酿造装置)
- 15 酿造装置
 - a 装置锁
 - b 防尘盖
- 16 弹出控制杆
- 17 滴水盘 (可取出)
 - a 滴水盘盖
 - b 咖啡渣盒
- 18 水滴托盘
- 19 固定件
 - a 牛奶软管
- 20 规格铭牌 (机器型号; 序号)
- 21 带有传感器的搁架 (用于牛奶盒)
- 22 牛奶盒
 - a 不锈钢牛奶盒
 - b 盖子下部
 - c 盖子上部



关于机器更多的信息, 例如如何将机门改变打开角度等问题, 请参见随附的安装说明书。

操作控件

为了使操作机器尽可能的简单, 同时提供各种功能的操作, 该机器配有容易理解的菜单控件。可从各种可能的操作方法上, 选择最少的操作步骤。

电源开关 [O/I]

利用电源开关 [O/I] (打开机门) 可将机器开启或完全关闭 (电源断开)。



重要: 操作过程中, 请勿触按电源开关。机器若在节能模式下会先关机, 从而进行自动清洗。

按键 [O]

触按 [O], 开启机器或进入节能模式。机器将自动清洗。

机器无法清洗, 原因是:

- 仍在开机等待暖机的状态。
- 关机前未冲泡咖啡。

机器一旦准备就绪, 就会在显示屏上显示饮料选项的符号。

按键 [M]

触按按键 [M], 调出菜单。可以进行设定、检索信息或将电器连接到“Home Connect” (参见“菜单”章节)。

按键 [U]

触按按键 [U], 调出保养程序。执行所需的程序, 如“保养程序”章节所述。

按键 [S]

触按按键 [S], 调出“个性化饮料制备”选项。个人设置的咖啡饮料可以保存并检索 (参见“个性化饮料”章节)。

按键 [D]

触按 [D], 可同时制备两份所选的饮料 (参见“同时制备两份”章节)。



再次触按 [M]、[U]、[S] 或 [D], 退出相应的菜单。

按键 [▷/□]

触按 [▷/□], 将启动饮料制备或保养程序。再次触按 [▷/□], 可在饮料制备过程中将程序提前中断。

显示屏设置选钮

转动功能选择钮, 可在显示屏上进行浏览或
将参数进行更改。

显示屏 (触摸屏)

显示屏上显示信息或触按触摸屏进行设置
(参见“显示屏”章节)。

启用

概述

仅限使用无碳酸的清洁冷自来水, 并仅将烘焙过的咖啡豆放入相应的咖啡豆箱。请勿使用非常油、上了焦糖或加了含糖添加物的咖啡豆, 因为这类咖啡豆容易阻塞酿造装置。



本机必须根据随附的安装说明书正确安装并连接, 然后才能开机及操作。

启动机器

- 移除机器保护膜。



重要: 仅能在无霜冻的地区使用本机。若在温度低于 0°C 的环境下进行运输或存放本机, 必须等待至少 3 小时再使用。

- 请握住隐藏式把手打开机门。
- 取出水箱、清洗并倒入干净的冷水至“max”(最高)标记处
- 再将水箱装回直到卡紧入位。
- 取出豆箱, 倒入咖啡豆, 然后装回。
- 将电源开关调至 [I], 然后关闭机门。

清洗并加热本机。

激活显示屏。

显示“选择语言”。

- 旋转功能选择钮, 选择所需的语言, 然后在显示屏上触按 [继续]。

显示“设置水硬度”。



正确设置水硬度非常重要, 这样机器才能适时显示何时应进行除垢程序。预设的水硬度等级是 4, 若家中有安装软水器, 请将水硬度调至等级 3。关于水硬度可向当地的供水单位查询。

- 或者, 您可以使用随机附送的试纸, 测试水硬度。将此试纸快速浸入饮用水一下, 约一分钟后, 试验结果将显示出来。

等级	水硬度	
	德国 (°dH)	法国 (°fH)
1	1-7	1-13
2	8-14	14-25
3	15-21	26-38
4	22-30	39-54

- 旋转功能选择钮, 调整确定的水硬度。
- 触按 [>]。显示“Home Connect”。
- 触按 [Home Connect 设置], 电器现在连接到无线网络 (家庭网络)。
- 触按 L, 电器稍后将连接到无线网络。显示“设置完成?”。
- 触按 [保存]。语言和水硬度的设定已保存。



选择 [Home Connect 设置] 时, 请阅读“Home Connect”章节内的详细说明。

若在显示屏上显示饮料符号, 机器已准备就绪。

每次冲泡饮料时, 内置风扇会自动开启, 数分钟之后又自动关闭。

机器于第一次使用、执行保养程序后或者长时间未使用时, 第一杯饮料完全不具香味, 请勿饮用。

启动全自动咖啡机后, 将在冲泡数杯之后, 才会有厚实而稳定的咖啡油脂。

关机

- 触按按键 [O]。

机器自动清洗并进入节能模式。

例外: 仅有冲制热水, 才无需清洗直接关机。

- 为了完全关闭本机, 请将机门打开, 并将电源开关调至 [O]。



重要: 操作过程中, 请勿触按电源开关。若机器在节能模式, 会先关机, 从而进行自动清洗。

本台全自动咖啡机的各项出厂设置均为呈现最佳性能而设计。机器在所选的时间后, 将自动进入节能模式并进行清洗 (时间可调, 参见“自动待机时间”, 位于“菜单”章节)。

机器配有传感器。若机器上有牛奶盒, 转为节能模式时会在显示屏上出现相应的显示。若有牛奶在牛奶盒中, 请放入冰箱保存。

显示屏

显示屏上将显示信息或通过触按触摸屏进行设置。

显示

显示屏上将显示可供选择的饮料、各种设置和设置内容以及回报现阶段正在进行的动作。

举例说明：

饮料选项







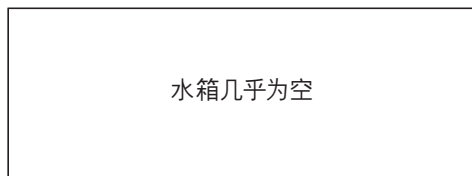

信息

一旦您按下按键或一段时间后，信息就会消失。



一个小符号将取代文字出现在显示屏的左下角。

-  豆箱几乎为空
-  水箱几乎为空
-  更换过滤器
-  需要执行清洁程序
-  需要执行除垢程序
-  需要执行钙化清洁程序

处理要求

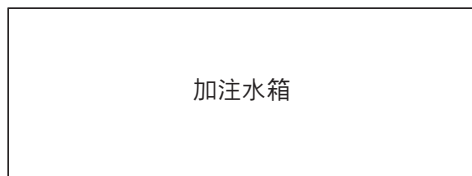

 一旦您采取动作，例如将水箱注水，相应的信息和符号再度消失。

操作

触按显示屏上的文字或符号，并配合旋转功能选择钮进行浏览（相关范例请参见“调整饮料”章节）。触按触摸屏会发出一次响音。开启或关闭讯号音（参见“菜单 - 按键音”章节）。

饮料制备

本台全自动咖啡机可以使用咖啡豆或咖啡预磨粉（非即溶咖啡）。

若使用咖啡豆，每次酿造皆为新鲜现磨的咖啡。为了获得最佳质量的咖啡豆，请将咖啡豆密封好并保存在阴凉处。

 **重要：**水箱应每天更换干净的冷水，请勿使用添加碳酸的水。保持足够的水量以维持机器的运作。

秘诀：请使用厚壁的小杯子，可用热水先预热。

在一些设置中，咖啡制备分成两步骤（参见“加倍香浓功能”及“同时制备两份”章节）。请等待冲泡程序完全结束。

饮料选项

旋转功能选择钮，选择不同的饮料：

所选的饮料符号将在显示屏中央显示。咖啡浓度和咖啡温度等当前的设定值均显示在触摸屏的左右两侧。



共有下列数种选择：

- 意式超浓咖啡
- 意式浓缩咖啡
- 浓缩玛奇朵
- 奶油咖啡
- 卡布奇诺
- 拿铁玛奇朵
- 拿铁
- 奶泡
- 温牛奶
- 热水

所选的饮料可直接使用预设值进行制备或预先调整到适合个人的口味。

i 本电器连接到 Home Connect 时，可以在 APP 中选择并调整“Coffeeworld”中的其他饮料。在 APP 中选定的最后一杯“Coffeeworld”饮料将显示在显示屏上，并可直接在本电器上进行调整和冲泡。

调整饮料

在显示屏上触按 [调整]，将根据饮料显示可调整不同字段。您可在反白显示字段上更改数值。

例如：

您可以如下所示更改一杯“奶油咖啡”的值：

■ 旋转功能选择钮，选择“奶油咖啡”。



■ 触按 [调整]。

将显示该字段的预设值。被选中的字段，例如 [①] 将以反白显示。



■ 旋转功能选择钮，设置所需的咖啡浓度，例如“①①①①”（强）。

■ 触按字段 [②]。



■ 旋转功能选择钮，设置所需的咖啡量，例如“160mL”。

■ 触按字段 [⏪]。



■ 旋转功能选择钮，设置所需的温度，例如“高温”。



■ 触按 [返回] 或开始冲泡饮料保存设置。

i 设置内容会根据饮料类型而不同。除牛奶仅能调整份量外，可对咖啡饮料，例如咖啡浓度、温度和咖啡量进行设置。

选择以下的设置：

咖啡的浓度

- ① 非常淡
- ①① 淡
- ①①① 标准
- ①①①① 强
- ①①①①① 非常强
- 2x① 加倍香浓强度
- 2x①① 加倍香浓强度+
- 2x①①① 加倍香浓强度++

i 加倍香浓功能

咖啡酿造的时间越长，释放出的苦味和意外异味越多。咖啡的味道和帮助消化的成分都因此受到影响。机器对于冲泡浓度非常强的咖啡将使用加倍香浓的功能。在咖啡制备一半饮用量时，重新将咖啡豆进行研磨并酿造，才能释放出宜人的、帮助消化的香浓成分。超浓咖啡、浓缩马琪朵以及研磨咖啡的制备不提供加倍香浓功能。

饮料温度

咖啡饮品值：

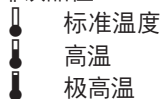

热水值：

- 70°C 白茶
- 80°C 绿茶
- 90°C 红茶
- 最高温 水果茶

份量



份量会根据饮料种类而有所不同，请以 mL 的步骤进行设置。



冲泡好的份量会根据牛奶的质量而有所不同。

若 30 秒左右没有操作机器的动作，本机将自动退出设置模式。所做的设置将自动保存。

使用咖啡豆制备

机器必须开启。

- 将杯子放在饮料出口下方。
- 旋转功能选择钮，选择“意式超浓咖啡”、“意式浓缩咖啡”或“奶油咖啡”。

显示屏上将显示所选的饮料以及该饮料对于咖啡浓度和咖啡份量的预设值。



可更改该设置，如“调整饮料”章节所述。

- 触按按键 [▷/□]，开始冲泡。咖啡酿造好后随即流入杯内。再次触按按键 [▷/□]，可将程序提前中断。

制备添加牛奶的咖啡

此全自动咖啡机具有一个内置的饮料出口。因此，可以制备添加牛奶的咖啡饮料或奶泡以及温牛奶。



烧伤危险！

饮料出口很烫。使用后应先让其冷却，然后才能触摸。

牛奶盒

该牛奶盒是为了与此台全自动咖啡机一起使用而研发。仅供家用，可将牛奶存放在冰箱里。隔热效果的牛奶盒能够将牛奶冷藏数小时。



重要：请将杯子或玻璃杯移开，才能开启机门，否则可能会倾倒。

然后连接牛奶容器或牛奶盒：

- 打开机门。
- 向前取下饮料出口的防尘盖。
- 连接并固定导奶管和连接件，如图所示。

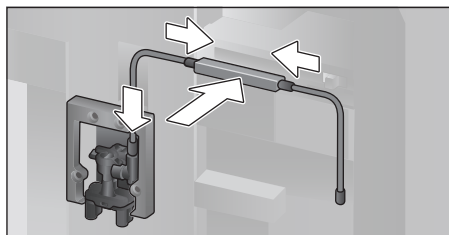

- 从前面将饮料出口的防尘盖装回固定。
- 将牛奶软管插上，并在另一头插入牛奶容器或牛奶盒。

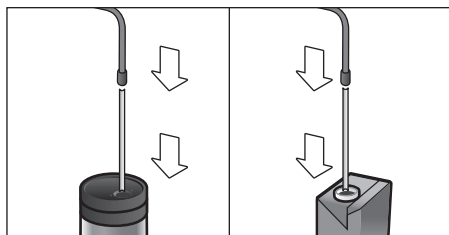

- 关上门机。



干燥凝固后的牛奶残渣非常难清除，因此务必清洗（参见“清洁加奶系统”章节）。

制备添加牛奶的咖啡

- 将杯子或玻璃杯放置在饮料出口下方。
 - 旋转功能选择钮, 选择“浓缩玛奇朵”、“卡布奇诺”、“拿铁玛奇朵”或“拿铁”。
- 显示屏上将显示所选的饮料以及该饮料对于咖啡浓度和咖啡份量的预设值。

 可更改该设置, 如“调整饮料”章节所述。

- 触控按键 [>/□], 开始冲泡。
- 牛奶会先流至杯子或玻璃杯内。然后酿造好的咖啡再流入杯子或玻璃杯内。
- 再次触控 [>/□], 可将程序提前中断。

奶泡或温牛奶

- 将杯子或玻璃杯放置在饮料出口下方。
- 旋转功能选择钮, 选择“奶泡”或“温牛奶”。

 可更改设置, 如“调整饮料”章节所述。

- 触控按键 [>/□], 开始冲泡。
- 奶泡或温牛奶从饮料出口流出。
- 再次触控 [>/□], 可将程序提前中断。

使用预磨咖啡粉制备

 使用预磨咖啡粉制备时, 无法提供咖啡浓度和同时制备两份的设置。

重要: 请将杯子或玻璃杯移开, 才能开启机门, 否则可能会倾倒。

机器必须开启。

- 打开机门。
- 取出粉剂抽屉。粉剂抽屉应保持干燥。
- 将预磨咖啡粉倒入粉剂抽屉内 (最多两平匙), 勿压平。

 **注意!**
请勿添加咖啡豆或即溶咖啡在预磨粉剂抽屉内。

- 插入粉剂抽屉。
- 关上机门, 显示屏将显示 ☞。

 若在 90 秒内没有冲泡咖啡的动作, 酿造装置会自动排空, 以免加注过量。清洗机器。

- 将杯子放置在饮料出口下方。
- 旋转功能选择钮, 选择咖啡饮料或添加牛奶的咖啡饮料。

显示屏上将显示所选的饮料以及该饮料的预设值。

 可更改设置, 如“调整饮料”章节所述。

请注意位于“制备添加牛奶的咖啡”章节内关于咖啡饮料添加牛奶的注意事项。

- 触控按键 [>/□], 开始冲泡。
- 咖啡酿造好后随即流入杯内。咖啡饮料选择添加牛奶时, 牛奶先会流出, 然后是酿造好的咖啡。

 若继续使用研磨咖啡粉冲泡咖啡, 请重复操作步骤。

冲制热水



烧伤危险!

饮料出口很烫。使用后应先让其冷却, 然后才能触摸。

机器必须开启。

- 请将牛奶盒的导奶管取下。
- 请清除饮料出口处的牛奶或咖啡残渣。
- 将杯子或玻璃杯放置在饮料出口的下方。
- 旋转功能选择钮, 选择“热水”。

 可更改设置, 如“调整饮料”章节所述。

- 触控按键 [>/□], 开始冲泡。
 - 显示信息“已从牛奶盒上拆下导奶管?”。
 - 若导奶管仍然连接, 请取下, 然后触控显示屏上的 [是]。
- 热水从饮料出口流出。
- 再次触控 [>/□], 可将程序提前中断。

个性化饮料

触控按键 [☞], 打开个性化饮料的选项。可使用多达 8 种不同的存储位置。此处存储个人偏好经常冲泡的饮料连同其所有的设置。

 触控 [☞], 可随时退出菜单, 不用进行保存。

创建或更改饮料

- 触按按键 []。
- 显示储存位置的选项。



- 旋转功能选择钮，选择一个空的存储位置（空杯）进行创建，或将已存在的存储位置进行变更或将个人偏好的饮料进行删除。
- 创建空的存储位置时，请选择 [新建饮料] 或在已存在的存储位置选择 [变更饮料]。

i 选择 [删除饮料] 时，将删除存储位置的设置，存储位置再次被清空。

显示调整饮料的菜单。显示上次冲泡的饮料连同上次所选择的设置。

- 若无保存上次冲泡的饮料，请旋转功能选择钮，选择另外的饮料。
- 每次请触按欲更改的相应设置，旋转功能选择钮，依个人喜好调整数值。

根据选项显示其它的设置内容。

- 触按 [继续]，继续其它设置。

i 对于添加牛奶的饮料，可设置咖啡和牛奶的混合比例。

- 该设置可以个人名称保存。触按 [保存名称]。显示名称输入的屏幕窗口。

3 4 5 6 7 8 9 ' _ < [A B C D E F G H I J K]										
<		A _ _ _ _ _							>	
取消						保存				

- 旋转功能选择钮，选择字母或符号。
- 触按 [>] 确定所选的字母，或触按 [<] 删除字母。
- 选择并确认其他字母或符号。
- 使用 [取消] 退出但不变更输入资料，显示饮料菜单。
- 使用 [保存] 保存输入的资料。显示菜单选项。
- 触按按键 []，退出菜单。

选择并冲泡个性化饮料

- 触按按键 []。
- 显示存储位置的选项。
- 旋转功能选择钮，选择所需的存储位置。
- 将杯子或玻璃杯放置饮料出口下方。
- 触按按键 [> / □]，开始冲泡。

同时制备两份

触按按键 []，可同时制备两份所选的饮料。通过同时制备两份符号的设置，将显示如“2x 意式浓缩咖啡”的字段。

- 旋转功能选择钮，选择所需的饮料。
 - 触按按键 []。
 - 在饮料出口下方左右两侧各放置一只杯子。
 - 触按按键 [> / □]，开始冲泡。
- 所选择饮料制备好后随即流入杯内。

i 咖啡分两步制备（两次研磨过程）。请等待冲泡程序完全结束。

“加倍香浓功能”或“咖啡粉制备”的设置无法提供同时制备两份。

设置研磨度

此台全自动咖啡机具有可调式研磨器。因此可依据各人喜好，更改咖啡研磨度。

- 打开机门。
- 使用滑块在研磨度细的咖啡 ☼ 和研磨度粗的咖啡 ☼ 之间选择设置研磨度。

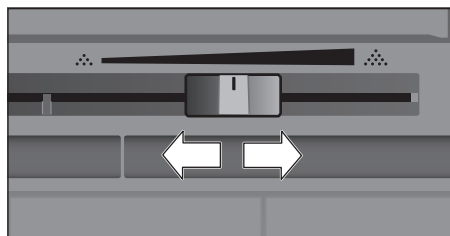

- 再度关上机门。

i 深色烘焙的咖啡豆适合磨细一点，浅色烘焙的咖啡豆才适合较粗的研磨度。

秘诀：研磨度的设置仅需小幅度更改。新的设置在第二份咖啡后才会变得明显。

显示屏显示信息“选择较粗的研磨度”，表示咖啡的研磨度太细。设置较粗的研磨度。

儿童安全锁

为了防止儿童烫伤和烧伤，可将机器锁定。

- 按住按键 [] 至少 4 秒钟。
显示屏将短暂显示“启用儿童锁”。
这时机器无法操作，仅能触按 [] 确定。
- 按住 [] 至少 4 秒钟，将儿童安全锁停用。
显示屏短暂显示“儿童安全锁已停用”。

菜单

您可依个人喜好，在菜单中更改您的设置、检索信息或开始程序。

- 触按按键 []，打开菜单。
显示屏将显示各种设置内容。

菜单浏览：

触按 [<] 及 [>]，可选择不同的设置内容，例如“语言”。

旋转功能选择钮，例如可设置“简体中文”。

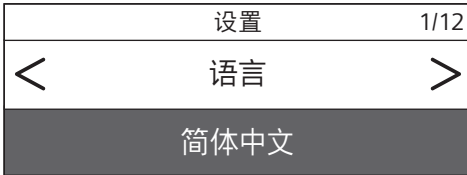

举例说明：

将机器设置在 15 分钟后自动关闭：

- 触按按键 []。将菜单打开。
- 按住 [>] 不放，直到显示屏上显示“自动待机时间”。
- 旋转功能选择钮，选择“0h 15min”。
- 触按按键 []。显示“保存更改？”。
- 触按 [保存]。机器将保存该设置。
显示屏显示饮料选项。

- i** 触按按键 []，可在任何时候退出菜单。若约 30 秒无任何输入动作，机器将自动关闭菜单，而且不保存该设置。

可进行以下的设置：

语言

在语言设置上显示所需显示的文字。

水硬度

设置当地的水硬度。

可选择从“1（软）”到“4（极硬）”的等级。预设的水硬度等级为“4（极硬）”。

- i** 正确设置水硬度非常重要，这样机器才能适时显示何时应进行除垢程序。

您可以使用随机附送的试纸测试水的硬度或咨询当地的供水单位。若家中有安装软水器，请设置“软水装置”。

过滤器

若需要插入、更换或拆下过滤器，必须在菜单上相应设置“插入”、“更换”或“拆下”过滤器。

- i** 过滤器可避免钙化，减少水中杂质，进而提高咖啡风味。过滤器可经由经销商或客户服务订购（参见“附件”章节）。

插入或更换过滤器：

使用新的过滤器之前，应先将过滤器清洗。

- 旋转功能选择钮，选择“插入”或“更换”。
- 将过滤器压入水箱凹槽中固定。

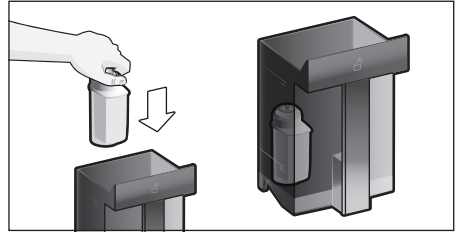

- 给水箱加水至“max”（最高）标记处。
- 取下牛奶盒的导奶管，然后关上机门。

- i** 注意：关上机门时，机门不得夹住导奶管。

- 将一个 0.5 升的容器放在饮料出口的下方。

- 触按按键 [> / □]。

这时水流经过滤器并对其进行清洗。

- 然后倒空容器。

机器可再次使用。

- i** 清洗过滤器的同时会启用更换过滤器的设置。

出现“更换过滤器”的信息或最迟两个月后，过滤器的作用已经耗尽。出于卫生考虑，请更换过滤器，以防止机器出现水垢沉积（这可能损坏机器）。

- 若无新的过滤器插入，请选择设置“拆下”，然后触按按键 [> / □]。

显示“拆下过滤器，重新插入水箱，关闭门”。

i 若机器已有很长的时间未使用（例如外出度假），第一次使用前，请清洗使用中的过滤器。方法是冲制一杯热水即可。

您可在随附的过滤器说明中找到关于过滤器的详细信息。

Home Connect

用于连接到无线网络（家庭网络）和移动设备的设定（参见“Home Connect”章节）。

自动待机时间

设置机器在冲泡最后一杯咖啡后，经过多久可自动清洗并关闭的时间。

可选值是从 15 分钟到 8 小时。预设的时间是 30 分钟。

照明

设置饮料出口的照明。可选择“开”、“使用时”或“关”。

照明亮度

设置饮料出口的照明亮度。可选的等级是从“等级 1”到“等级 10”。

显示屏亮度

设置显示屏亮度

按键音

开启或关闭讯音。

时钟显示

时间和日期“关”或“数字”（开）的显示内容。可进一步在菜单项目中进行设置。

i 使用电源开关关闭机器或电源发生故障时，时间的设置会丢失。

时间

设置当前的时间。

日期-星期

设置当前的日期。

日期-月份

设置当前的月份。

日期-年

设置当前的年份。

防冻

机器的保养程序是避免运输或存放时遭受霜冻的损害。进行此程序时，请完全清空机器。

■ 触控 [启动]，启动程序。

■ 清空并再次插入水箱。

■ 必要时取下牛奶盒，然后关闭机门。

机器自动清空管道系统。

■ 请清空并插入滴水盘。

饮料信息

显示机器启动至今制备多少饮料。

■ 触控 [显示]，显示信息。

出厂设置

您可以取消您的个别设置，回到出厂设置状态。

■ 旋转功能选择钮，选择“复位”。显示“确定要复位？”。

■ 触控 [复位] 确定或使用 [取消] 中断。

Home Connect

本机咖啡机具有 Wi-Fi 功能，并可通过移动设备（例如平板电脑、智能手机）进行远程遥控。Home Connect App 所提供的附加功能与网络电器相得益彰。

若电器未连接到无线网络（家庭网络），它的功能就像一般没有网络连接的咖啡机，还是可以一如往常通过显示屏进行操作。

重要注意事项：

家庭网络的路由器必须在 2.4 吉赫兹的频率范围内才可运行。请检查，必要时加以设置。

Home Connect 功能是否可用取决于该服务在您的所在国是否可用。Home Connect 服务并非在所有国家都可用。如需了解更多信息，请访问：www.home-connect.cn。

i 若您出门在外并通过 Home Connect App 进行操作时，请注意本说明书一开始的安全注意事项并确实遵守。请同时遵守在 Home Connect App 的注意事项。

电器上的操作在任何时候都优先进行，这段期间无法通过 Home Connect App 进行操作。

设定

为了能够通过 Home Connect 进行设定，请将 Home Connect App 安装在移动设备（例如平板电脑、智能手机）上。遵守意随附的 Home Connect 使用说明。请按照 App 所指定的步骤进行设定。咖啡机初始启动时可直接登录无线网络或通过菜单（先按按键 [menu]，打开菜单）完成：

■ 按住箭头键 [>] 不放，直到显示屏上显示“Home Connect”。

■ 触控 [Home Connect 设置]。

- 触控 [关 Wi-Fi], 启动无线连接。显示屏显示“开 Wi-Fi”。
- 触控 [網絡連線]。显示选项 [自動連線] 和 [手動連線]。

 若控制器使用 WPS 功能, 请选择 [自動連線]。

自动连接到无线网络 (家庭网络)

- 触控 [自動連線]。显示屏显示 [網絡自動連線]。
- 在数分钟内按家庭网络控制器上的 WPS 按钮, 直到咖啡机的显示屏上显示“網路連線成功”。
- 打开移动设备上的 App。
- 触控 [其它]。
- 触控 [連接到 app]。本台咖啡机自动连接到 App。
- 请等到显示屏上 [成功连接至app] 短暂亮起。
- 触控 [远程启动]。出现一条警告讯息。
- 触控 [其它], 并读取警告讯息。
- 触控 [確認]。

现在利用移动设备, 可以通过 App 对咖啡机的全部功能进行操控。

 选择 [停用] 远程开启时, 将只在 Home Connect App 上显示咖啡机的运作状态。可以进行设定, 但不启动任何饮料制备。

手动连接到无线网络 (家庭网络)

- 触控 [手動連線]。本台咖啡机将创建一个自有的无线网络, 可以通过平板电脑或智能手机进行访问。显示屏将显示此网络的 SSID (名称) 和 Key (密码)。
- 在流动端设备上以 SSID “HomeConnect” 和 Key “HomeConnect” 即可登录咖啡机的自有网络。
- 启动移动设备上的 App, 并遵照 App 上网络登录的指示和随附的 Home Connect 说明。

咖啡机显示屏上“網路連線成功”短暂亮起, 登录过程才算完成。

- 触控 [其它]。
- 触控 [連接到 app]。本台咖啡机连接到 App。
- 请等到显示屏上 [成功连接至app] 短暂亮起。

- 触控 [远程启动]。出现一条警告讯息。
- 触控 [其它], 并读取警告讯息。
- 触控 [確認]。

现在利用移动设备, 可以通过 App 对咖啡机的全部功能进行操控。

 选择 [停用] 远程开启时, 将只在 Home Connect App 上显示咖啡机的运作状态。可以进行设定, 但不启动任何饮料制备。

开启与关闭 Wi-Fi

可视需求将 Wi-Fi 切换为“开”或“关”(例如度假时)。

 电器关闭后仍将保留网络信息。开启数秒钟后, 请等到咖啡机重新连接到无线网络。

本电器在联网待机模式下最大需要 2 W。

- 触控按键 [menu], 打开菜单
- 按住箭头键 [>] 不放, 直到显示屏上显示“Home Connect”。
- 触控 [Home Connect 设置]。
- 触控 [Wi-Fi], 切换无线模式为“开”或“关”。

其它设定

Home Connect 可以随时根据个人需求进行调整。

注意: 本台咖啡机应连接到无线网络。

断开连接

本台咖啡机可以随时断开与无线网络的连接。

 若咖啡机断开与无线网络的连接, 便无法通过 Home Connect 进行任何操控。

- 触控按键 [menu], 打开菜单。
- 按住箭头键 [>] 不放, 直到显示屏上显示“Home Connect”。
- 触控 [Home Connect 设置]。
- 触控 [断开网络]。

断开网络和 App 的连接。Wi-Fi 和远程开启已关闭。

 有关无线网络的信息将被删除。

连接到 App

可在任意数台移动设备上安装 Home Connect App，并连接到咖啡机。本台咖啡机必须已经连接到无线网络。

- 打开移动设备上的 App。
- 触按按键 [menu]，打开菜单
- 按住箭头键 [>] 不放，直到显示屏上显示“Home Connect”。
- 触按 [Home Connect 设置]。
- 触按 [其它]。
- 触按 [與 app 連線]，将本电器连接到 App

远程开启

例如，若要通过移动设备在咖啡机上启动饮料制备，应激活远程开启。



烧伤危险！

无人看守的情况下进行远程开启时，若有人在饮料流出期间触摸咖啡出口下方，可能造成第三方烫伤的危险。因此，在无人看守的情况下进行远程开启时，请确保不会对他人，尤其是儿童，或者对财物造成危险。



成功完成与 Home Connect 连接后，只有在文本框才能看见 [远程启动]。若关闭远程开启，只能在 Home Connect App 显示咖啡机的运作状态。

- 触按按键 [menu]，打开菜单
- 按住箭头键 [>] 不放，直到显示屏上显示“Home Connect”。
- 触按 [Home Connect 设置]。
- 触按 [其它]。
- 触按 [远程启动]，切换远程开启功能为“开”或“关”。

电器信息

网络和电器信息显示

- 触按按键 [menu]，打开菜单
- 按住箭头键 [>] 不放，直到显示屏上显示“Home Connect”。
- 触按 [Home Connect 设置]。
- 触按 [其它]。
- 触按 [电器信息]。将显示 SSID、IP、MAC 位址和本电器的序号数秒钟。

显示屏

显示屏上，我们将在右上角通过一个符号显示 Home Connect 的状态：



连接到网络



未连接到网络



无法连接到服务器

远程诊断

发生故障时，客户服务可以通过远程诊断访问您的电器。请联系客户服务并确保您的电器已连接到 Home Connect 服务器，并检查在您所在的国家是否有提供远程诊断服务。

有关您所在国家远程诊断服务的可用性和其他信息，请至您所在国家的 Home Connect 网页 www.home-connect.cn 的帮助及支持页面查看相关内容。

数据保护注意事项

本台咖啡机在第一次连接到与互联网相连的网络时，将传输咖啡机下列各类数据至 Home Connect 服务器上（首次注册）：

- 唯一机器标识符（包括电器密钥以及已安装 Wi-Fi 通信模块的 MAC 位址）。
 - Wi-Fi 通信模块的安全证书（信息技术的连接保障）。
 - 本台咖啡机当前的软件和硬件版本。
 - 将之前任何的状态恢复至出厂设置。
- 此首次注册是准备提供给 Home Connect 功能使用，并在您第一次使用 Home Connect 功能时，才会被使用。



请注意，Home Connect 功能只有在连接 Home Connect App 时才能使用。您可在 Home Connect App 中调出数据保护的相关信息。

符合性声明

BSH Hausgeräte GmbH 谨此声明使用 Home Connect 功能的电器符合基本要求并满足指令 2014/53/EU 的其它有关条文。您可以通过联机访问 www.siemens-home-bsh-group.com，在电器的产品页面中获取详细的 RED 符合标准声明以及其它文档。

2.4 吉赫兹频段：最大 100 兆瓦

维护和日常清洁



有电击危险！

请勿将机器浸泡在水中。请勿使用蒸汽清洁剂。

- 请使用湿软布擦拭外壳。
- 请以超细纤维布清洁显示屏。
- 请勿使用任何含酒精或苯的清洁剂。
- 请勿使用摩擦型洗涤剂。

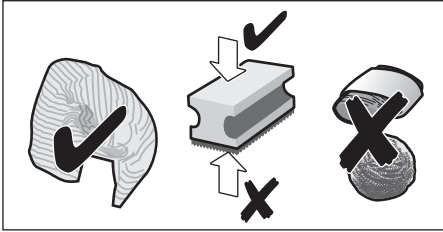

- 请立即去除水垢、咖啡、牛奶或清洁剂以及除垢液残留物。这些残留物会导致腐蚀。



新的海绵抹布可能黏附有盐。盐会导致不锈钢产生锈膜，所以在使用海绵前请彻底清洗。

- 打开机门，将滴水盘往前取下。
- 取下滴水盘盖和咖啡渣盒。
- 请清空、清洁以及晾干部件。



重要：请每天清空并清洁滴水盘和咖啡渣盒，防止污垢堆积。

- 取出粉剂抽屉，并用水冲洗，然后晾干。

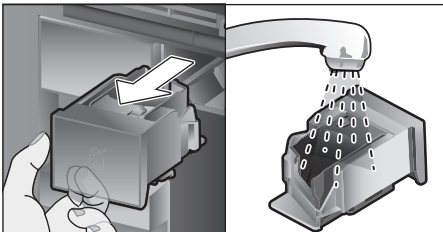

- 请擦拭并晾干机器内部（滴水盘和粉剂抽屉）及水滴托盘。
- 请装上晾干的部件，例如粉剂抽屉。



以下部件请勿放入洗碗机清洗：

附件盒、水箱、水箱盖、饮料出口防尘盖、咖啡豆箱、咖啡豆箱盖、连接件的

金属、粉剂抽屉、酿造装置保护盖、酿造装置以及牛奶盒。



以下部件适合洗碗机清洗：

搁板、水滴托盘、滴水盘、滴水盘盖、咖啡渣盒、导奶管、牛奶软管、单件饮料出口、咖啡勺以及单件牛奶盒盖。



若本机在冷状态下开启或在冲泡咖啡后关闭，机器将自动清洗。系统将自行清洗。

重要：若机器已有很长时间未使用（例如外出度假），请将机器彻底清洗，包括加奶系统、粉剂抽屉以及酿造装置。

清洁加奶系统

制备添加牛奶的饮料后，将用短暂的空喷蒸汽自动清洁加奶系统。



秘诀：可用水额外的彻底清洗加奶系统（参见“清洗加奶系统”章节）。

重要：加奶系统应每周进行清洁，必要时也可以经常清洁（参见“手动清洗加奶系统”章节）。



烧伤危险！

饮料出口很烫。使用后应先让其冷却，然后才能触摸。

清洗加奶系统

- 触按按键 [0]，然后旋转功能选择钮，选择“清洗加奶系统”。
- 触按按键 [▷/□]，开始程序。
- 打开机门，将牛奶软管从牛奶盒上取下。
- 擦拭牛奶软管，并将牛奶软管的一端插入咖啡渣盒孔。

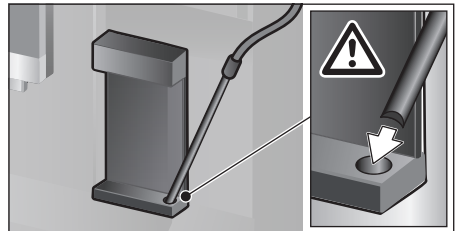

- 关上机门。请勿卡住导奶管。
 - 将空玻璃杯放置在饮料出口的下方。
 - 触按按键 [▷/□]。
- 请以清水清洗加奶系统。
- 然后倒空玻璃杯。

- 触按 [⏏], 退出程序。

手动清洗加奶系统

将加奶系统拆卸清洗：

- 将饮料出口整个推至底部，然后将防尘盖向前取下。
- 按下饮料出口左侧的锁杆，便可将饮料出口向前拉出。

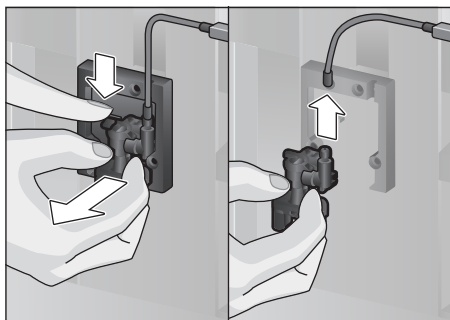

- 取下导奶管。拆卸饮料出口的上下部件。

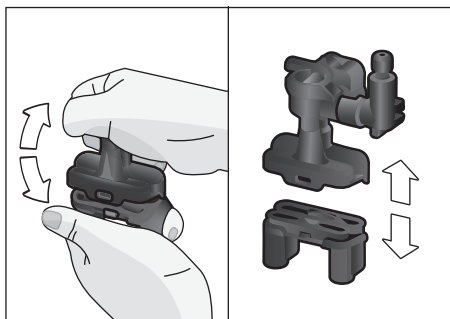

- 拆开导奶管、连接件以及牛奶软管。

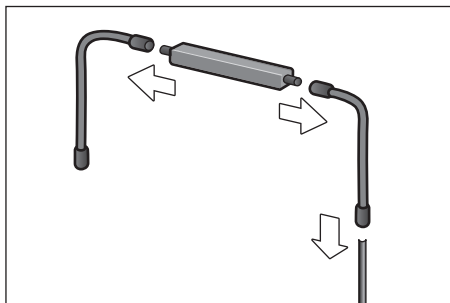

- 可使用洗涤液和软布清洁单件。
- 将所有的部件用清水洗净并晾干。

- 将各部件重新组装起来（另见快速指南）。

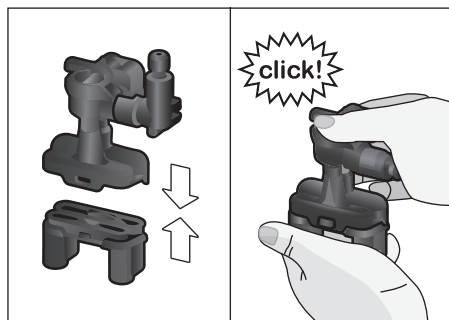

- 饮料出口直接从前面装回至三个接口固定。
- 重新装上防尘盖。

清洁加奶系统

出于卫生考量，应定期清洁牛奶盒。仅有单件盖子适合放入洗碗机洗涤。请用手以温和的清洁剂清洗不锈钢牛奶盒。

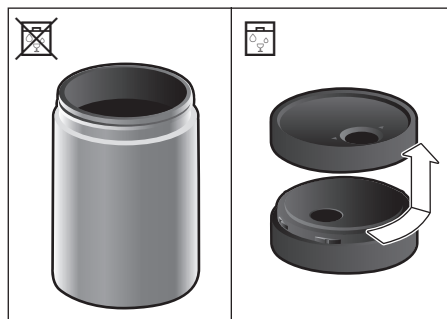

清洁酿造装置

(另见快速指南)

除了使用自动清洁程序外，也应定期将酿造装置取出清洁。

- 打开机门。
- 电源开关 [O/I] 可将机器完全关闭。
- 将保护盖从酿造装置上取下。
- 取出咖啡渣盒。
- 将酿造装置上的红色装置锁整个向左推至 ☞ 的位置。
- 将弹出控制杆整个往下压。酿造装置将松开。
- 抓紧酿造装置的隐藏式把手，小心取下。

- 取下盖子，用水彻底冲洗酿造装置。

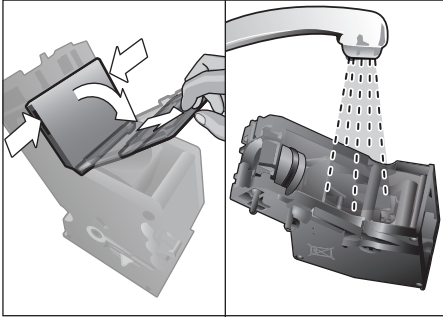

- 在水龙头下将酿造装置的过滤器冲洗干净。

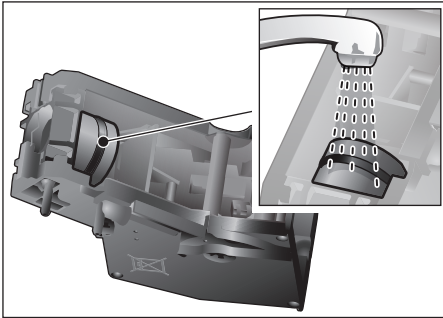

- 请彻底清洁酿造单元的连接销。

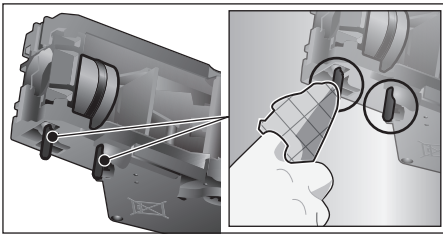

 **重要：**请勿用洗洁精清洗，也不得放入洗碗机洗涤。

- 彻底地清洁机器内部，注意清除咖啡残留物。
- 让酿造装置和机器内部晾干。
- 请重新将防护盖盖在酿造单元上。
- 将酿造单元推回电器内，并按中央部位直至其卡紧为止。

 **注意：**红色装置锁应在安装前整个推到最左边 0 的位置 (参见图 E)。

- 将弹出控制杆整个向上推，将红色装置锁整个向右推至 0。
- 装上咖啡渣盒。
- 重新盖上防护盖。
- 关上机门。

保养程序

(另见快速指南)

显示屏会不定期显示

“执行除垢程序！”

或者

“执行清洁程序！”

或者

“执行钙化清洁程序！”。

此时应立即采取相应的程序，清洁机器或给机器除垢。您可通过钙化清洁程序，选择将除垢和清洁程序一起执行 (参见“钙化清洁”章节)。您还可以随时启动保养程序，无需等到显示屏上出现提示信息，避免机器遭受损坏。

 **重要：**若本机未正确除垢，将显示“除垢程序逾期 电器稍候将被锁定！”。请在出现提示后立即执行除垢程序。若本机被锁定，只能在完成除垢程序后重新操作。

为了显示还可以冲泡多少饮料，请在进行保养程序前，执行以下步骤：

- 触控 [∅]
- 旋转功能选择钮，选择“服务信息”。
- 触控 [显示]，调出信息。



注意！

请依照说明书上的指示，使用保养程序的除垢和清洁剂片，使用时请留意(相应)的安全注意事项。

切勿中断保养程序！

请勿饮用任何程序所产生的液体。

切勿使用柠檬酸、醋或含醋的产品为您的电器除垢。

请勿将除垢剂或其他除垢剂放入粉剂抽屉内！

**重要：**

开始各个保养程序前（除垢程序、清洁或钙化清洁程序），请将酿造装置取下，根据指示清洁并重新装上。

关机门时，请勿卡住导奶管。

在完成每个保养程序后，请立即用柔软的湿布擦去除垢和清洗液的残留物。这些残留物会导致腐蚀。

新的海绵抹布可能黏附有盐。盐会导致不锈钢产生锈膜，所以在使用海绵前请彻底清洗。请彻底清洁饮料出口、导奶管以及连接件。

专为这款全自动咖啡机而研发的除垢和清洁片片剂，可经由经销商和客户服务订购（参见“附件”章节）。



使用滤水器时，时间间隔将延至必须执行除垢程序为止。

除垢程序

所需时间：约 21 分钟。

- 触按 []。
- 旋转功能选择钮，选择“除垢”。
- 触按按键 [/]。显示屏将带领您完成整个程序。
- 清空并重新装回滴水盘。
- 必要时，请取出过滤器，然后触按按键 [/]。
- 在空水箱中加入微温水至“0.5 升”的标记处，然后将两片除垢片片剂 00311556 溶解在水中。



若水箱中的除垢溶液太少，将显示相应的要求。请倒入无碳酸的水，然后再次触按按键 [/] 确定。

- 从牛奶盒中取下并擦拭牛奶软管，并将牛奶软管的一端插入咖啡渣盒孔。
- 关上机门。
- 请将 0.5 升容量的容器放置在饮料出口的下方。
- 触按按键 [/]。除垢程序将运行约 19 分钟。
- 请移开容器，然后触按 [/] 确定。
- 清洗水箱，（必要时）请重新装回过滤器。
- 在水箱中加入干净的水至“max”（最高）标记处。
- 重新装回水箱，然后关上机门。
- 将容器重新放置在饮料出口的下方。

- 触按按键 [/]。除垢程序将运行约 2 分钟，然后清洗机器。
- 将容器取下、清空并重新装回滴水盘，然后关上机门。
- 触按 [/]。除垢程序完成，机器可再使用。
- 触按 []，退出程序。

清洁

所需时间：约 5 分钟。

- 触按 []。
- 旋转功能选择钮，选择“清洁”。
- 触按按键 [/]。显示屏将带领您完成整个程序。
- 清洁并重新插入饮料出口，清空并重新插入滴水盘。
- 打开粉剂抽屉，放入一片清洁片片剂，然后关上粉剂抽屉。
- 关上机门。
- 请将 0.5 升容量的容器放置在饮料出口的下方。
- 触按按键 [/]。清洁程序将运行约 5 分钟。
- 将容器取下、清空并重新装回滴水盘，然后关上机门。
- 触按 [/]。清洁程序完成，机器可再使用。
- 触按 []，退出程序。

钙化清洁

所需时间：约 26 分钟。

除钙程序将原本独立的清洁和除垢功能结合在一起。若两个功能的运行时间彼此皆很接近，本全自动咖啡机会自动建议采用此保养程序。

- 触按 []。
- 旋转功能选择钮，选择“钙化清洁”。
- 触按按键 [/]。显示屏将带领您完成整个程序。
- 清洁并重新插入饮料出口，清空并重新插入滴水盘。
- 打开粉剂抽屉，放入一片清洁片片剂，然后关上粉剂抽屉。
- 取下过滤器，（必要时）请触按 [/]。
- 在空水箱中加入微温水至“0.5 升”的标记处，然后将两片除垢片片剂 00311556 溶解在水中。



若水箱中的除垢溶液太少，将显示相应的要求。请倒入无碳酸的水，然后再次触按按键 [▷/□] 确定。

- 从牛奶盒中取下并擦拭牛奶软管，并将牛奶软管的一端插入咖啡渣盒孔。
 - 关上机门。
 - 请将 0.5 升容量的容器放置在饮料出口的下方。
 - 触按按键 [▷/□]。
- 该程序将运行约 19 分钟。
- 请移开容器，然后触按 [▷/□] 确定。
 - 清洗水箱，(必要时)请重新装回过滤器。
 - 在水箱中加入干净的水至“max”(最高)标记处。
 - 重新装回水箱，然后关上机门。
 - 将容器重新放置在饮料出口的下方。
 - 触按按键 [▷/□]。

该程序将运行约 7 分钟，然后清洗机器。

- 将容器取下、清空并重新装回滴水盘，然后关上机门。
- 触按 [▷/□]。除垢程序完成，机器可再次使用。
- 触按 [⏏]，退出程序。

特殊清洗



重要：若保养程序其中之一发生中断，例如电源故障，请按显示屏的信息继续以下的步骤：

- 清洗水箱，然后在水箱中加入干净的水至“max”(最高)标记处。
- 触按按键 [▷/□]。该程序将运行约 2 分钟，然后清洗机器。
- 清空并重新装回滴水盘，然后关上机门。机器可再次使用。
- 触按 [⏏]，退出程序。

节能秘诀

- 触按 [⏏]，机器将进入“节能模式”。机器在“节能模式”的状态下耗电量非常低，但仍继续监控所有与安全相关的功能，以防止损坏。
- 在菜单的“自动待机时间”设置 15 分钟后自动关闭。
- 可在菜单中设置减少显示屏亮度和照明，这样可以更省电。
- 请尽量不去中断正在冲泡的咖啡或奶泡。提前终止进行中的程序，将耗费更多的电能，滴水盘也会满得较快。

- 请定期执行机器的除垢程序，以免水垢累积。水垢会消耗更多的电能。

防冻保护

为了避免在运输和存放的过程中受到霜冻的伤害，在之前应完全清空机器(参见“菜单 - 防冻”章节)。

存放附件

本台全自动咖啡机内配有用于存储附件和快速指南的专用附件收放处。

- 咖啡勺和过滤器皆放置在附件收放处中。
- 快速指南收在附件收纳盒前面的特殊夹缝中。
- 长型导奶管则存放在机门内侧的搁架上。
- 连接件在粉剂抽屉上方的磁架上固定。

附件

以下附件可经由经销商及客户服务订购：

附件	订购号 客户服务
清洁片剂	00311807
除垢片剂	00576693
过滤器	00575491
保养组	00576330
带有“freshLock”上盖的牛奶盒。	00576166
用于 92° 开启角度的限制件	00636455

废弃物处理



对本设备根据有关电气和电子设备报废的欧洲规定 2012/19/EU (waste electrical and electronic equipment - WEEE) 进行标记。该规定管理在欧洲范围内对报废设备的回收和再生。

保修

该设备的保修条款将由售出国的销售代表来确定。您可向售出此设备的经销商详细了解这些条款。

当根据保修条款进行任何索赔时，必须出具销售凭证或收据。

如有更改，恕不另行通知。

简单故障排除

故障	原因	解决办法
咖啡和奶泡质量差异太大(例如份量有差异或奶泡溢出)。	机器结垢。	机器请按说明书进行除垢, 参见“保养程序”章节。
	导奶管被堵塞。	请清洁导奶管。
无法冲泡饮料。	饮料出口或三个接口其中之一被堵塞。	请清洁导奶管和接口。
饮料在冲泡时从出口整个涌出。	饮料出口下部件故障。	安装下部件, 参见“清洁加奶系统”章节。
奶泡不足或没有奶泡或是导奶管无法引入牛奶。	机器结垢。	机器请按说明书进行除垢, 参见“保养程序”章节。
	饮料出口或三个接口其中之一被堵塞。	请清洁导奶管和接口。
	牛奶不适合打泡。	请勿使用已煮过的牛奶。使用脂肪含量至少为 1.5% 的冰牛奶。
	饮料出口或导奶管安装不当。	将部件浸湿并重新安装。
	导奶管被堵塞。	请清洁导奶管。
未达到个人设置的份量, 咖啡流速成滴状或完全停流。	研磨度设置得太细。咖啡粉太细。	研磨度设置得太粗。使用较粗的咖啡粉。
	机器结垢严重。	请按照说明书对机器进行除垢, 参见“保养程序”章节。
	酿造单元变脏。	请清洁酿造单元, 参见“清洁酿造装置”章节。
热水尝起来有牛奶或咖啡的味道。	导奶管尚未取下。	将导奶管从牛奶盒上取下。
	饮料出口有牛奶或咖啡的残渣。	清洗饮料出口。
煮出的咖啡无咖啡“油脂”。	使用不适当的咖啡种类。	改用罗布斯塔含量较高的咖啡豆。
	咖啡豆不新鲜。	使用新鲜的咖啡豆。
	研磨度与咖啡豆不相配。	研磨度设置得太细。
咖啡太“酸”。	研磨度设置得太粗。咖啡粉太粗。	研磨度设置得太细。使用较细的咖啡粉。
	使用不适当的咖啡种类。	请更换咖啡的种类。
咖啡太“苦”。	研磨度设置得太细。咖啡粉太细。	研磨度设置得太粗。使用较粗的咖啡粉。
	使用不适当的咖啡种类。	请更换咖啡的种类。
咖啡尝起来有“焦味”。	酿造温度太高。	降低温度, 参见“调整饮料”章节。
	研磨度设置得太细。咖啡粉太细。	设置较粗的研磨度。使用较粗的咖啡粉。
	使用不适当的咖啡种类。	请更换咖啡的种类。

故障	原因	解决办法
咖啡太淡。	选择的咖啡浓度太低。	提高咖啡浓度，参见“调整饮料”章节。
	咖啡粉在粉剂抽屉内堵塞。	取出粉剂抽屉，清洗并彻底晾干。
咖啡粉仍留在粉剂抽屉内。	咖啡粉黏在一起。	请勿在粉剂抽屉内将咖啡粉往下压。
	粉剂抽屉有湿气。	取出粉剂抽屉，清洗并彻底晾干。
水箱中的过滤器未固定到位。	过滤器安装不正确。	将过滤器垂直向下用力压入水箱接口。
咖啡豆箱在插入时卡住。	咖啡豆在外壳中。	取出咖啡豆。
咖啡渣未压实和过湿。	研磨度设置得过细或过粗或使用的咖啡粉太少。	将研磨度调至更粗或更细，或使用两平匙的咖啡粉。
研磨调整装置运行不平滑。	研磨器里太多咖啡豆。	冲泡一杯来自咖啡豆的饮料。更改研磨度，仅限较小幅度的调整。
酿造装置不能插入。	酿造装置的位置不正确。	请按说明书将酿造装置插入，参见“清洁酿造装置”章节。
	酿造装置已锁定。	将酿造装置锁定，参见“清洁酿造装置”章节。
酿造装置的防护盖无法正确安装。	酿造装置无法锁定。	锁定酿造装置，参见“清洁酿造装置”章节。
滴水盘底部有水，	有可能是冷凝水。	请勿插入没有装上盘盖的滴水盘。
显示屏显示“12:00”	电源故障或机器使用电源开关关闭。	若输入新值，机器无法用电源开关关闭或在菜单时钟显示中调为“关”。
显示屏显示“是否已连接牛奶盒？” 虽然已连接牛奶盒。	牛奶盒不在传感器的侦测范围内。	请将牛奶盒放置在机器的右侧。
	未侦测到物料，例如牛奶盒。	触按“是”确定显示屏的询问或使用随附的牛奶盒。
显示屏显示“电压过高或过低！”	过高或过低的电压。	请与电力供应商或电力运营商联系。 由受过训练的专业人员检查电源电压。
显示屏显示“请让电器冷却”	电器过热。	关闭电源 30 分钟。
显示屏显示，例如：“故障: E0510”	机器发生故障。	请根据显示屏进行操作。
显示屏显示“请添加咖啡豆” 虽然咖啡豆已装满或研磨器没有研磨咖啡豆的动作。	咖啡豆没有掉入研磨器内(咖啡豆过油)。	轻轻拍打咖啡豆箱。必要时，请更换咖啡豆种类。用干布将空咖啡豆箱擦干净。

故障	原因	解决办法
显示屏显示 “清洁酿造单元”	酿造单元不干净。	请清洁酿造单元。
	酿造单元内的咖啡粉过多。	请清洁酿造单元。最多倒入 2 平匙的咖啡粉。
	酿造单元的机件运行不平滑。	请清洁酿造单元，参见“维护和日常清洁”章节。
显示屏显示 “重新加满不含碳酸的水或 拆下过滤器”	水箱插入错误	请正确插入水箱
	水箱内有含碳酸的水。	请将新鲜的自来水注入水箱内。
	浮标在水箱被卡住。	请取下水箱，然后彻底清洁。
	若不遵循说明书清洗新的过滤器，可能导致过滤器的耗损。	请根据说明书清洗过滤器，然后再使用或使用新的过滤器。
	过滤器有气泡。	请将过滤器浸泡在水中一段时间，直到无气泡逸出，再将过滤器重新插入。
显示屏显示 “清空滴水盘” 尽管已清空滴水盘。	滴水盘又脏又湿。	请将滴水盘彻底清洁并晾干。
	关机时，未侦测到已清空。	开机时，请将滴水盘取出并重新插入。
显示屏显示 “插入滴水盘” 尽管滴水盘已插好。	机器内部（滴水盘）不干净。	请清洁机器内部。
	咖啡渣盒未完全插入卡紧。	请将咖啡渣盒插入卡紧。
常见需要除垢的显示。	水质太硬。	插入滤水器并在菜单中进行相应的设置。
取出滴水盘后，水滴在机器内的底部。	滴水盘过早取下。	最后一次冲泡饮料后，请等待数秒，再将滴水盘取下。
显示屏显示 “请打开门，使用电源开关关机，并在30秒后再开机！”	机器过热。	让机器冷却。
	酿造单元不干净。	请清洁酿造单元。
Home Connect 没有正常工作。		转至 www.home-connect.cn

若有任何问题，请务必拨打热线电话！
全国统一客户服务热线详见说明书第7页。

技术数据

电气连接 (电压 – 频率)	220-240 伏~ – 50/60 赫兹
电力负载	1600 瓦
最大泵压 (静态)	19 巴
水箱的最大容量 (无过滤器)	2.4 升
咖啡豆箱的最大容量	500 克
电源线的长度	1.7 米
尺寸 (高 x 宽 x 深)	455 x 495 x 375 毫米
重量, 空机	19 - 20 公斤
研磨器的种类	陶瓷

Contents

Included in delivery (for use)	29
Congratulations	30
Intended use	31
Important safety information	31
Overview	33
Controls	33
Initial use	34
Display	35
Preparing drinks	36
Preparation using coffee beans	38
Preparation using milk	38
Preparation using ground coffee	39
Dispensing hot water	40
Personalised drinks	40
Two cups at once	41
Adjusting the grind setting	41
Childproof lock	41
Menu	42
Home Connect	44
Care and daily cleaning	47
Service programmes	50
Tips on energy saving	53
Frost protection	53
Storing accessories	53
Accessories	53
Disposal	53
Guarantee	53
Simple troubleshooting	54
Technical specifications	57

Included in delivery (for use)

(Figure A on the fold-out pages)

- a** Fully automatic coffee machine
- b** Instruction manual
- c** Quick reference guide
- d** Measuring spoon
- e** Water hardness testing strip
- f** Milk tube (set)
- g** Milk container
- h** Suction pipe

Congratulations ...

... on purchasing this fully automatic coffee machine! You have now acquired a high-quality and modern kitchen appliance. It combines innovative technology with a range of functions and is easy to use. It will enable you to prepare a variety of delicious hot drinks quickly and simply – whether you're in the mood for an invigorating espresso, a creamy cappuccino, a smooth latte macchiato or white coffee, or a traditional cup of coffee. At the same time the appliance offers you a wide range of options for adapting it to your individual taste.

To ensure that you can use this fully automatic coffee machine with all its functions and features reliably and safely, we would like you to familiarize yourself with its components, functions, displays and controls. These instructions are designed to help you. So please take the time to read them before you switch on the appliance.

Technical specifications:

Voltage: 220V-240V~

Frequency: 50-60Hz

Power rating: 1600W

Country of origin:

Slovenia

Exclusive distributor:

BSH Home Appliances (China) Co., Ltd.

Zhongnan International Tower Building 20 and 21, No. 129 Zhongshan Road, Nanjing

Applicable Standards:

GB 4706.1-2005

Safety of Household and Similar Electrical Appliances Part 1: General Requirements

GB 4706.19-2008

Safety of Household and Similar Electrical Appliances – Particular Requirements for Liquid Heaters

GB 4706.30-2008

Safety of Household and Similar Electrical Appliances – Particular Requirements for Kitchen Machines

How to use these instructions

You can open up the front cover of this instruction manual. There you will find illustrations of the appliance with each part numbered. These numbers will be referred to throughout the text.

Example: brewing unit (15)

These instructions also show display texts and symbols in a special way. These enable you to clearly see where we refer to texts or symbols that are marked or displayed on the appliance.

Display indicators:

“Espresso”

Buttons and controls on the display:

[▷/□]

The appliance comes with a quick reference guide where you can find the most important functions at a glance. It can be stored in the accessory drawer of the appliance.

Caroline: 4008899999

Service E-mail: careline.china@bshg.com

Intended use

Check the appliance after unpacking it. Do not connect the appliance if it has been damaged in transit.

This appliance is intended for domestic use only.

Only use the appliance indoors at room temperature and up to 2000 m above sea level.

Important safety information

Please read and follow the operating instructions carefully and keep them for later reference! Enclose these instructions when you give this appliance to someone else.

This appliance can be used by children aged from 8 years and above and by persons with reduced physical, sensory or mental capabilities or lack of experience and knowledge if they have been given supervision or instruction concerning use of the appliance in a safe way and if they understand the hazards involved. Keep children under 8 years of age away from the appliance and connecting cable and do not allow them to use the appliance. Children shall not play with the appliance. Cleaning and user maintenance shall not be made by children unless they are older than 8 years and supervised.

Warning

Risk of electric shock!

- The appliance may only be connected to a power supply with alternating current via a correctly installed socket with earthing. Ensure that the protective conductor system of the domestic supply has been correctly installed.
- Connect and operate the appliance only in accordance with the specifications on the rating plate.
- Do not use the appliance if the power cord and/or appliance are damaged.
- Only our customer service may repair the appliance, e.g. by replacing a damaged power cord, in order to avoid hazards.
- If the supply cord is damaged, it must be replaced by a special cord or assembly available from the manufacturer or its service agent.
- Never immerse the appliance or mains cord in water.
- If there is a fault, pull out the mains plug immediately or switch off the power supply.
- Avoid spillage on the connector.
- Please note the special information on cleaning in the instructions.

⚠ Warning

Hazard due to magnetism!

The appliance contains permanent magnets which can affect electronic implants such as pacemakers or insulin pumps. Persons wearing electronic implants must maintain a minimum distance of 10 cm from the appliance and from the following parts upon removal: milk container, milk system, water tank and brewing unit.

⚠ Warning

Risk of suffocation!

- Do not allow children to play with packaging material.
- Store small parts safely as they can be easily swallowed.

⚠ Warning

Risk of injury!

- Do not reach into the grinding unit!
- Be careful not to jam your fingers when closing the door.
- A misuse of the appliance can potentially lead to injury.

⚠ Warning

Risk of burns!

- The beverage outlet gets very hot. After use, always let it cool down before you touch it.
- After the use the heating element surfaces can be subjected to residual heat.
- Freshly prepared beverages are very hot. Leave to cool a little if necessary.

⚠ Warning

**Risk of scalding
(Home Connect)!**

If an unattended remote start takes place, third parties might be scalded if they reach under the coffee dispenser during drinks dispensing. You should therefore make sure that with an unattended remote start that there is no risk to other people, in particular not to children, or to property.

Overview

(Figures B to E on the fold-out pages)

- 1 **Appliance door**
 - a Recessed grip (for opening the door)
 - b Drip plate
- 2 **Display**
- 3 **Controls**
- 4 **Outlet system (coffee, milk, hot water), height-adjustable**
 - a Cover
- 5 **Milk system**
 - a Snap lever
 - b Beverage outlet (upper part, lower part)
 - c Milk tube (2 pieces)
 - d Connecting element, metal (for magnet holder)
- 6 **Mains switch [O/I] (power supply)**
- 7 **Accessory drawer (for quick reference guide and accessories)**
 - a Quick reference guide
 - b Measuring spoon
 - c Water hardness strip
 - d Milk tube (set)
- 8 **Removable water tank**
 - a Lid for water tank
- 9 **Removable bean container**
 - a Lid for bean container
- 10 **Slide regulator for grinding degree setting**
- 11 **Magnet holder (for connecting element)**
- 12 **Removable drawer (for ground coffee/cleaning tablet)**
- 13 **Holder (for milk tube)**
- 14 **Protective cover (for brewing unit)**
- 15 **Brewing unit**
 - a Locking mechanism
 - b Cover
- 16 **Eject lever**
- 17 **Removable Drip tray**
 - a Drip tray cover
 - b Coffee grounds container
- 18 **Collecting tray**
- 19 **Holder**
 - a Suction pipe
- 20 **Rating plate (E number, FD)**

21 Storage shelf with sensor (for milk container)

22 Milk container

- a Stainless steel container
- b Lower part of the lid
- c Upper part of the lid



Further information about the appliance, such as how to change the opening angle of the door, can be found in the assembly instructions.

Controls

The appliance features user-friendly menu navigation to ensure that operation is as easy as possible while at the same time offering a wide range of functions. That means a range of options can be selected with just a few operating steps.

Mains switch [O/I]

Use the mains switch [O/I] (to do so open the door) to switch on the appliance, or to switch it off fully (power supply off).



Important: Do not press the mains switch while the appliance is in use. Switch off the appliance only when it is in energy saving mode, so that it can rinse automatically.

Button [⏻]

Press button [⏻] to switch on the appliance or change it to energy saving mode. The appliance is rinsed automatically.

The appliance does not rinse if:

- if it is still warm when switched on, or
- if no coffee was dispensed before it was switched off.

The appliance is ready for use as soon as the symbols for the drinks selection appear on the display.

Button [≡]

Press button [≡] to open the menu.

Settings can be made, information called up or the appliance connected with “Home Connect” (see section “Menu”).

Button []

Press button [] to open the selection of service programmes. Run the desired programme as described in the section “Service programmes”.

Button []





Press button [] to open the selection of “Personalised beverage preparation”. Personal settings for coffee drinks can be saved and called up (see the section “Personalised drinks”).

Button []

Press button [] after selecting a drink to prepare two cups simultaneously (see the section “Two cups at once”).

 Press [], [], [] or [] again to exit the respective menu.

Button [/]

Press [ / ] to either begin preparing a drink or launch a service programme. Press [ / ] again while the drink is being prepared to prematurely halt dispensing.

Rotary selector

Turn the rotary selector to navigate in the display or to change parameters.

Display (Touchscreen)

Information is shown on the display, or settings can be made by touching the touchscreen (see the section “Display”).

Initial use

General

Fill the appropriate container using only pure, **cold**, uncarbonated water and solely **roasted** beans. Do not use coffee beans that have been glazed, caramelised or treated with other additives containing sugar, since they will block the brewing unit.

 Before the appliance can be switched on and used, it must be assembled and connected according to the enclosed assembly instructions.

Setting up the appliance

- Remove any protective plastic film.

 **Important:** Only use the appliance in a frost-free room. If it has been transported or stored at temperatures below 0°C, wait at least 3 hours before initial use.

- Take hold of the appliance door by the recessed grip and open.
- Remove the water tank, rinse it and fill it with fresh water up to the “max” mark.
- Replace the water tank and click into place.
- Remove the bean container, fill with coffee beans and replace.
- Set the mains switch to I and close the appliance door.

The appliance heats up and is rinsed.

The display is activated.

“Select language” appears.

- Turn the rotary selector to select the desired language and touch [Continue] in the display.

“Set water hardness” appears.

 It is important to set the water hardness correctly to enable the appliance to accurately indicate when the descaling programme should be run. The preset water hardness is level 4. If a water softener is installed in the house, please set the water hardness to level 3. You can also check the water hardness by asking your local water supplier.

- Use the enclosed test strip to determine the water hardness. Briefly dip the test strip in water and check the result after one minute.

Level	Water hardness	
	German (°dH)	French (°fH)
1	1-7	1-13
2	8-14	14-25
3	15-21	26-38
4	22-30	39-54

- Turn the rotary selector to set the water hardness determined.

- Touch [>]. “Home Connect” appears.
- To now connect the appliance to the WLAN network (home network), touch [Home Connect settings].
- To connect the appliance to the WLAN network later on, touch [>]. “Complete set-up?” appears.
- Touch [Save]. The settings for Language and Water hardness are saved.

i When selecting [Home Connect settings] please read the detailed description in the section “Home Connect”.

The appliance is ready to use when the drink symbols are shown on the display.

The integrated fan switches on each time a drink is dispensed and switches off again after a few minutes.

When the appliance is used for the first time after running a service program, or if it has not been operated for a long period, the first beverage will not have the full aroma and should not be consumed.

When the fully automatic coffee machine is first used, a suitably thick and stable “crema” is only achieved after the first few cups have been dispensed.

Switch off appliance

- Press the [⏻] button.
The appliance rinses and switches to energy saving mode.

Exception: If only hot water is dispensed, the appliance switches off without rinsing.

- To switch the appliance off completely, open the appliance door and set the mains switch to [⏻].

i **Important:** Do not press the mains switch while the appliance is in use. Switch off the appliance only when it is in energy saving mode, so it can rinse automatically.

i The factory settings of the fully automatic coffee machine are programmed for optimal performance. The appliances switches automatically to the energy saving mode after a configured time and rinses (duration can be set, see “Home Connect” in the section “Menu”).

The appliance is equipped with a sensor. If there is a milk container, this will be correspondingly shown on the display when switching to the energy saving mode. If there is milk in the container, please keep in the fridge.

Display

Information is shown on the display, or settings can be made by touching the touchscreen.

Display

The display shows the selected drinks, settings and setting options, as well as messages about the appliance’s operating status.

Examples:

Drink selection









Information

Information disappears after pressing the button or after a short time.

Water tank almost empty

Instead of text, a small symbol appears in the lower left area of the display.

-  Bean container almost empty
-  Water tank almost empty
-  Change water filter
-  Cleaning programme required
-  Descaling programme required
-  calc'nClean programme required

Prompts to take action

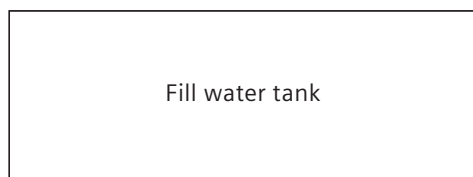

i If the action required was carried out, e.g. filling the water tank, the corresponding message and symbol will disappear.

Operation

Touch texts or symbols combined with turning the rotary selector to navigate within the display (for an example, see section “Drink adjustment”).

An audible signal is heard when touching the display. These audible signals can be switched on or off (see the section “Menu – Key tones”).

Preparing drinks

This fully automatic coffee machine can be operated using coffee beans or ground coffee (but not instant coffee).

If using coffee beans, they will be freshly ground for each brewing. For optimum quality, store the beans in a cool place in sealed containers.

i **Important:** Fill the water tank with fresh, uncarbonated, cold water every day. The tank should always contain sufficient water for operating the appliance.

i **Tip:** Cups should be prewarmed, e.g. with hot water. This applies particularly to small thick-walled espresso cups.

For some settings, coffee is prepared in two stages (see the section “aromaDouble Shot” and “Two cups at once”). Please wait until the process is completely finished.

Drink selection

Turn the rotary selector to select different drinks:

The symbol for the drink selected is shown in the middle. The name of the drink and the values currently set, e.g. for the strength and volume are shown in upper row.



The following drinks can be selected:

- Ristretto
- Espresso
- Espresso Macchiato
- Coffee
- Cappuccino
- Latte Macchiato
- Caffe Latte
- Milk froth
- Warm milk
- Hot water

The drink selected can be directly prepared with the pre-set values or first adjusted to individual taste.

i If the appliance is connected to Home Connect, additional drinks can be selected from “Coffeeworld” and adjusted in the app. The last “Coffeeworld” drink selected in the app is shown in the display and can also be adjusted and dispensed directly at the appliance.

Drink adjustment

Touch [Adjust] on the display and different fields will appear, depending on the drink, for adjustment.

The field where the value can be changed has a dark background.

An example:

The values for a cup of coffee can be changed as follows:

- Use the rotary selector to select "Coffee".

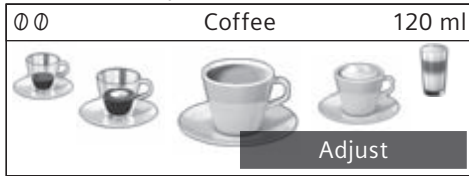

- Touch [Adjust].

The fields containing the preset values appear. The active field, e.g. [0] has a dark background.



- Turn the rotary selector to set the strength of coffee desired, e.g. "0000" (strong).
- Touch the field [0]

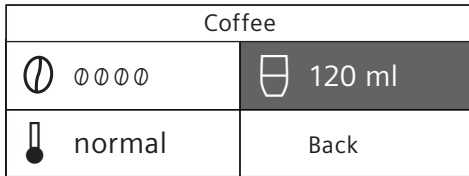

- Turn the rotary selector to set the required amount of coffee, e.g. "160 ml".
- Touch the field [0].

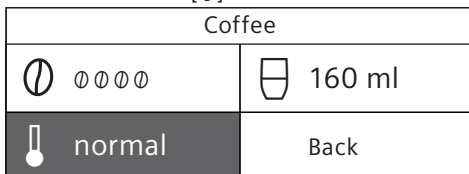

- Turn the rotary selector to set the desired temperature, e.g. "high".



- Save the settings by touching [Back] or by starting to dispense the drink.

i There are different setting options depending on the type of drink. For coffee drinks, for example, the strength, temperature and quantity can be set, for milk only the volume.

The following settings are possible:

Coffee strength



- 0 Very mild
- 00 Mild
- 000 Regular
- 0000 Strong
- 000000 Very strong
- 2x0 aromaDouble Shot strong
- 2x00 aromaDouble Shot strong+
- 2x000 aromaDouble Shot strong++

i **aromaDouble Shot**
The longer the coffee is brewed, the more bitter substances and undesired aromas are released. This has a negative effect on the taste and makes the coffee less easily digestible. So for extra strong coffee, the appliance has a special aromaDouble Shot function. When half the quantity has been prepared, it grinds and brews fresh coffee beans so that only the pleasant, aromatic scents are released.

The aromaDouble Shot function is not available for ristretto, espresso macchiato, and when ground coffee is used.

Drink temperature

Values for coffee drinks:

-  normal
-  high
-  very high

Values for hot water:

- 70°C White tea
- 80°C Green tea
- 90°C Black tea
- Max Fruit tea

Volume



The volume differs depending on the type of drink and can be set in ml steps.



The volume dispensed can fluctuate depending on the quality of the milk.

If no controls are activated for approx. 30 seconds, the appliance will automatically exit the settings mode. The settings made will be automatically stored.

Preparation using coffee beans

The appliance must be ready for use.

- Place a cup underneath the beverage outlet.
- Use the rotary selector to select “Ristretto”, “Espresso” or “Coffee”.

The display shows the selected drink along with the preset values for the strength of the coffee and the amount for this drink.



The settings can be changed as described in the section “Drink adjustment”.

- Press [>/□] to start dispensing.

The coffee is brewed and then dispensed into the cup.

Press button [>/□] again to stop dispensing prematurely.

Preparation using milk

This fully automatic coffee machine has an integrated beverage outlet. This can be used to prepare coffee drinks with milk or also milk froth and warm milk.



Risk of burns!

The beverage outlet gets very hot. After use, always let it cool down before you touch it.

Milk container

The milk container has been designed especially for use together with this fully automatic coffee machine. It is intended solely for use in the household and for storing milk in the refrigerator. The insulated container keeps milk cool for a number of hours.



Important: Remove cups or glasses before opening the door in case they fall.

Connecting the milk container or a milk carton:

- Open the appliance door.
- Remove the cover of the beverage outlet towards the front.
- Connect and fix the milk tubes and connecting elements as illustrated.

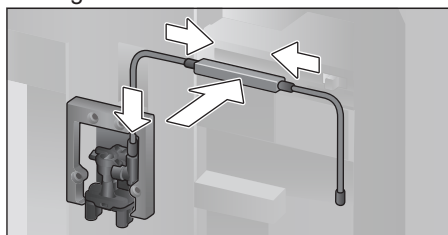

- Attach the cover firmly from the front on to the beverage outlet.

- Attach the suction pipe and insert into the milk container or a milk carton.

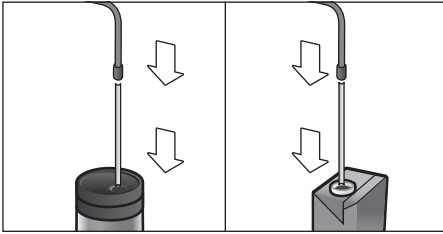

- Close the appliance door.

i Dried milk residues are difficult to remove, therefore **always** clean (see the section “Cleaning the milk system”).

Coffee drinks with milk

- Place a cup or glass underneath the beverage outlet.
- Select “Espresso Macchiato”, “Cappuccino”, “Latte Macchiato” or “Caffe Latte” with the rotary selector.

The display shows the selected drink along with the preset values for the strength of the coffee and the amount for this drink.

i The settings can be changed as described in the section “Drink adjustment”.

- Press [▷/□] to start dispensing. The milk is dispensed into the cup or glass first. Then the coffee is brewed and runs into the cup or glass. Press button [▷/□] again to stop the current step of the process prematurely.

Milk froth or warm milk

- Place a cup or glass underneath the beverage outlet.
- Select “Milk froth” or “Warm milk” with the rotary selector.

i The settings can be changed as described in the section “Drink adjustment”.

- Press [▷/□] to start dispensing. Milk froth or warm milk is dispensed from the beverage outlet.

Press button [▷/□] again to stop the current step of the process prematurely.

Preparation using ground coffee

i When using ground coffee, the setting for the strength of the coffee and dispensing two cups at once is not available.

Important: Remove cups or glasses before opening the door in case they fall.

The appliance must be ready for use.

- Open the appliance door.
- Remove the ground coffee drawer. The removable drawer must be dry.
- Put in coffee powder (maximum 2 level measuring spoons); do not press firmly.

i **Caution!** Do not use whole beans or instant coffee.

- Replace the ground coffee drawer.
- Close the appliance door, ☒ will appear on the display.

i If coffee is not dispensed within 90 seconds, the brewing chamber empties automatically to avoid an overflow. The appliance is then rinsed.

- Place a cup underneath the beverage outlet.
- Using the rotary selector, select a coffee drink or a coffee drink with milk. The display shows the selected drink along with the preset values for this drink.

i The settings can be changed as described in the section “Drink adjustment”.

For coffee drinks with milk, please observe the instructions in the section “Preparation using milk”.

- Press [▷/□] to start dispensing.

The coffee is brewed and then dispensed into the cup. When selecting coffee drinks with milk, the milk is first dispensed and then the coffee brewed.

i For another drink with ground coffee, repeat the procedure.

Dispensing hot water

⚠ Risk of burns!
The beverage outlet gets very hot. After use, always let it cool down before you touch it.

The appliance must be ready for use.

- Remove the milk tube from the milk container.
- Remove any milk or coffee residue from the outlet.
- Place a cup or glass underneath the beverage outlet.
- Select “Hot water” with the rotary selector.

i The settings can be changed as described in the section “Drink adjustment”.

- Press [▷/□] to start dispensing.
- The message appears “Milk tube removed from milk container?”.
- If still connected, remove the milk tube and touch [Yes] on the display.

Hot water flows out of the beverage outlet. Press button [▷/□] again to stop the procedure prematurely.

Personalised drinks

Press [☰] to open the selection for personalised drinks.

Up to 8 storage spaces can be used. Save your favourite drinks that are frequently dispensed here with all their settings.

i Press [☰] to exit the menu without saving at any time.

Entering or changing drinks

- Press [☰].

The selection of memory locations appears.



- Using the rotary selector, choose an empty memory location (empty cup) to make a new entry, or an occupied memory location to change or delete a favourite drink.
- At an empty memory location [Create beverage] or an occupied memory location [Change beverage].

i If [Delete beverage] is selected, the settings for the memory location are deleted and it is again empty.

The menu for adjusting the drinks opens. The last drink dispensed is shown with the last settings selected.

- If you do not wish to save last drink dispensed, select another drink with the rotary selector.
- Touch each setting to be changed and adjust the values as desired with the rotary selector.

Other setting options appear depending on the selection.

- Touch [Continue] to make other settings.

i For milk drinks, the mixing ratio of coffee and milk can be set.

- The settings can be stored under an individual name. Touch [Save name]. The mask for entering the name opens.

3 4 5 6 7 8 9 ` _ < [A] B C D E F G H I J K										
<	A _ _ _ _ _ _ _ _									>
Cancel						Save				

- Using the rotary selector, select a letter or a symbol in the upper row.

- Touch [✓] to confirm the letter selected or [<] to delete it.
- Select other letters or symbols and confirm.
- Touch [Cancel] to exit the entry without any modification and open the drinks menu.
- With [Save] the entry is adopted. The selection menu opens.
- Press [✕] to exit the menu.

Select a personalised drink and dispense

- Press [✕].
- The selection of memory locations opens.
- Use the rotary selector to select the desired memory location.
 - Place a cup or glass underneath the beverage outlet.
 - Press [▷/◻] to start dispensing.

Two cups at once

Press [☞] to prepare two cups of the selected drink simultaneously. The setting is shown by a second cup symbol and as text, e.g. "2 x Espresso".

- Use the rotary selector to select the desired drink.
- Press [☞].
- Place two cups left and right underneath the beverage outlet.
- Press [▷/◻] to start dispensing.

The selected drink is prepared and then dispensed into both cups.

i The drink is prepared in two stages (two grinding operations). Please wait until the process is completely finished.

Two cups at once cannot be dispensed for the settings "aromaDouble Shot" or "ground coffee".

Adjusting the grind setting

This fully automatic coffee machine has an adjustable grinding unit. This enables the grinding level of the coffee to be individually changed.

- Open the appliance door.
- Slide the regulator to select the grinding degree setting between finely ground coffee ☼ and coarsely ground coffee ☼.

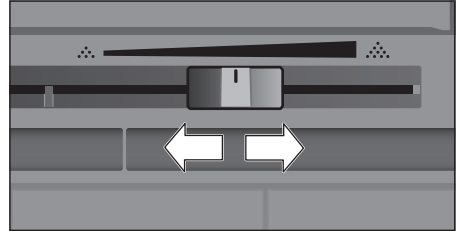

- Close the appliance door again.

i For dark roast coffee beans, choose a finer grind, for lighter beans a coarser grind.

Tip: Only make small changes to the grinding degree setting.

i The new setting will not become apparent until after the second cup of coffee.

If the display shows the message "Select a coarser degree of grinding", this means that the beans are being ground too finely. Adjust the grinding level to a coarser setting.

Childproof lock

The appliance can be locked to protect children against scalding and burns.

- Press and hold the [] button for at least 4 seconds.

"Childproof lock activated" briefly appears on the display.

No further operation is now possible; only [○] can be pressed.

- To deactivate the child lock, press and hold the [] button for at least 4 seconds.

"Childproof lock deactivated" briefly appears on the display.

Menu

The menu is used for changing individual settings, accessing information and launching processes.

- Press [] to open the menu. The different setting options will appear.

Navigating through the menu:

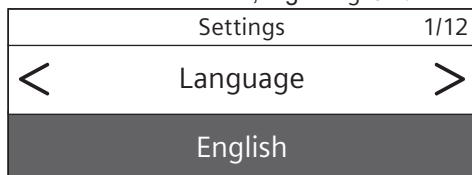

Press [<] and [>] to select the various setting options, e.g. "Language".

Turn the selector to set, e.g. "English".



For example:

Set the appliance at 15 minutes to switch off automatically:

- Press button []. The menu opens.
- Touch [>] repeatedly until the display shows "Switch off after".
- Turn the rotary selector and select "0h 15min".
- Press button []. "Save changes?" appears.
- Touch [Save]. The setting is saved. The drink selection appears on the display.

- i** Press [] to exit the menu at any time. If no entry is made within approx. 30 seconds, the menu closes automatically and the settings are not saved.

The following settings can be made:

Language

Set the desired language to show the display texts.

Water hardness

Set this to the local water hardness. Level "1 (soft)" to "4 (very hard)" can be selected. The preset water hardness is "4 (very hard)".

- i** It is important to set the water hardness correctly to enable the appliance to accurately indicate when the descaling programme should be run.

You can check the water hardness using the enclosed test strip or by asking your local water supplier. If a water softening system is installed in the house, please select the "Softening device" setting.

Water filter

If a water filter is inserted, renewed or removed, the setting "Insert", "Replace" or "Remove" must be made in the menu.

- i** A water filter lessens limescale deposits, reduces impurities in water and improves the coffee taste. Water filters are available from retail outlets or from customer services (see the section "Accessories").

Inserting or renewing a water filter:

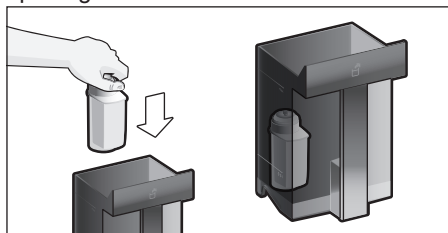

A new water filter must be rinsed before it can be used.

- Select either "Insert" or "Replace" with the rotary selector.
- Press the water filter firmly into the opening of the water tank.



- Fill the water tank with water up to the "max" mark.
- Remove the milk tube from the milk container and close the door.

- i** **Caution:** Do not jam the tube when closing the door.

- Place a container with a capacity of 0.5 litre under the outlet .
- Press button [ / ].

Water will now flow through the filter to rinse it.

- Then empty the container. The appliance is ready for use again.

 Rinsing the filter simultaneously activates the setting for the change filter display.

The filter is no longer effective when the "Replace water filter" display appears, or at the latest after two months. It needs to be replaced for reasons of hygiene and to prevent a build-up of limescale (which could damage the appliance).

- If a new filter is not inserted, select the setting "Remove" and press button [▷/□].

The message "Remove filter, reinsert water tank, close door" appears.

 If the appliance has not been used for a prolonged period (for example, while you are on holiday), the existing filter should be rinsed before the first time the appliance is used again. To do this, simply dispense a cup of hot water.

Detailed information about the water filter can be found in the manual supplied with the filter.

Home Connect

Settings for connection to WLAN network (home network) and mobile devices (see section "Home Connect").

Switch off after

To set how long the appliance should wait after the last drink was prepared before it automatically rinses and switches itself off. You can specify values from 15 minutes to 8 hours. The factory setting is 30 minutes.

Illumination

Setting the illumination of the beverage outlet. "On", "When in use" or "Off" can be selected.

Brightness illumination

Setting the illumination lightness of the beverage outlet. "Level 1" to "Level 10" can be selected.

Brightness display

Setting the illumination lightness of display.

Key tones

Switch the signal tones on or off.

Clock display

Display option for time and date "Off" or "Digital" (on). The settings for this can be changed in the next menu options.

 If the appliance is switched off at the mains or there is a power failure, the settings for the time and date will be lost.

Clock

Setting for the current time.

Date-day

Setting for the current day.

Date-month

Setting for the current month.

Date-year

Setting for the current year.

Frost protection

Service programme to prevent frost damage during transportation and storage.

This programme completely empties the appliance.

- Touch [Start] to begin running the programme.

- Empty the water tank and reinsert.

- If available remove the milk container and close the door.

The appliance automatically empties all its pipes.

- Empty the drip tray and re-insert.

Beverage info

Display shows how many drinks have been prepared since its initial use.

- Touch [Display] to show the information.

Factory settings

Resets your own settings to the condition when delivered.

- Select "Reset" with the rotary selector. The message "Are you sure?" appears.

- Touch [Reset] or [Cancel] to either confirm or interrupt.

Home Connect

This fully automatic coffee machine is Wi-Fi-capable and can be remotely controlled using a mobile device (e.g. tablet PC, smartphone). The Home Connect App offers additional functions which are a perfect complement to the networked appliance.

If the appliance is not connected to the WLAN network (home network), it functions in the same way as a fully automatic coffee machine with no network connection and can be operated as usual via the display.

Important information:

The home network router must be operated in the 2.4 GHz frequency range. Please check it and adjust it if necessary.

The availability of the Home Connect function depends on the availability of Home Connect services in your country. Home Connect services are not available in every country. You can find more information on this at www.home-connect.com.



Please ensure that you follow the safety instructions given at the beginning of this instruction manual and that these are also observed when operating the appliance via the Home Connect App and when away from home. Please also follow the instructions in the Home Connect App.

Operation on the appliance itself always takes priority, and during this time it is not possible to operate the appliance using the Home Connect App.

Setting up

To implement settings via Home Connect, you must have installed the Home Connect App on a mobile device (e.g. tablet PC, smartphone). Please observe the supplied Home Connect documents with regard to this. Follow the steps specified by the app to implement the settings.

Login of the appliance in the WLAN network can be carried out on initial set-up of the fully automatic coffee machine either directly or using the menu (first press [] to open the menu):

- Touch arrow key [>] repeatedly until the display shows “Home Connect”.
- Touch [Home Connect Settings].
- Touch [Wi-Fi Off] to start the wireless connection. “Wi-Fi On” appears in the display.
- Touch [Connect network].
The following selection appears:
[Connect automatically] and
[Manually connect].



If the router has WPS functionality, please select [Connect automatically].

Connect automatically in the WLAN network (home network)

- Touch [Connect automatically]. The display shows [Automatic network connection].
- Press the WPS button on the home network router within a few minutes and wait until the display of the fully automatic coffee machine shows “Network connection successful”.
- Open the app on the mobile device.
- Touch [Next].
- Touch [Connect with app]. The fully automatic coffee machine connects with the app.
- Wait until [Successfully connected with app] lights up briefly in the display.
- Touch [Remote start]. A warning message appears.
- Touch [Next] and read the warning message.
- Touch [confirm].

With the mobile device the functions of the fully automatic coffee machine can now be used to their full extent via the app.

 If [Remote start] - [Deactivate] is selected, only the modes of the fully automatic coffee machine are displayed in the Home Connect App. You can specify settings but not start drinks dispensing.

Connect manually in the WLAN network (home network)

- Touch [Manually connect]. The fully automatic coffee machine sets up a separate WLAN network which can be accessed with a tablet or smartphone. The display shows the SSID (the name) and the key (the password) of this network.
- Log the mobile device in to the network of the fully automatic coffee machine with the “HomeConnect” SSID and the “HomeConnect” key.
- Start the app on the mobile device and follow the instructions for network login in the app and the supplied Home Connect documents.

The login process is complete when “Network connection successful” lights up briefly in the display of the fully automatic coffee machine.

- Touch [Next].
- Touch [Connect with app]. The fully automatic coffee machine connects with the app.
- Wait until [Successfully connected with app] lights up briefly in the display.
- Touch [Remote start]. A warning message appears.
- Touch [Next] and read the warning message.
- Touch [confirm].

With the mobile device the functions of the fully automatic coffee machine can now be used to their full extent via the app.

 If [Remote start] - [Deactivate] is selected, only the modes of the fully automatic coffee machine are displayed in the Home Connect App. You can specify settings but not start drinks dispensing.

Switching Wi-Fi on and off

Wi-Fi can be switched “On” or “Off” as required (e.g. when on holiday).

 Network information is retained after the appliance is switched off.

After switching on, wait a few seconds until the fully automatic coffee machine has connected to the WLAN network again.

In networked standby mode the appliance requires a maximum of 2 W.

- Press button [⏏] to open the menu.
- Touch arrow key [➤] repeatedly until the display shows “Home Connect”.
- Touch [Home Connect Settings].
- Touch [Wi-Fi] to switch the wireless module “On” and “Off”.

Additional settings

Home Connect can be adapted to your individual needs at any time.

Note: The fully automatic coffee machine must be connected to the WLAN network.

Disconnecting

The fully automatic coffee machine can be disconnected from the WLAN network at any time.

 If the fully automatic coffee machine is disconnected from the WLAN network, it cannot be operated using Home Connect.

- Press button [⏏] to open the menu.
- Touch arrow key [➤] repeatedly until the display shows “Home Connect”.
- Touch [Home Connect Settings].
- Touch [Disconnect from network].

The connection to the network and app is disconnected. Wi-Fi and remote start are switched off.

 Information about the WLAN network is cleared.

Connecting with app

The Home Connect App can be installed on any number of mobile devices, which can then be used to connect to the fully automatic coffee machine.

The fully automatic coffee machine must already be connected to the WLAN network.

- Open the app on the mobile device.
- Press button [] to open the menu.
- Touch arrow key [>] repeatedly until the display shows "Home Connect".
- Touch [Home Connect Settings].
- Touch [Next].
- Touch [Connect with app] to connect to the appliance with the app.

Remote start

If you wish e.g. to start drinks dispensing on the fully automatic coffee machine via a mobile device, Remote start must be activated.



Risk of burns!

If an unattended remote start takes place, third parties might be scalded if they reach under the coffee dispenser during drinks dispensing. You should therefore make sure that with an unattended remote start that there is no risk to other people, in particular not to children, or to property.



The [Remote start] text field is only visible if connection with Home Connect has been successfully completed.

If Remote start is switched off, only the modes of the fully automatic coffee machine are displayed in the Home Connect App.

- Press button [] to open the menu.
- Touch arrow key [>] repeatedly until the display shows "Home Connect".
- Touch [Home Connect Settings].
- Touch [Next].
- Touch [Remote start] to switch the function Remote start "On" and "Off".

Device Info

Display for network and device information

- Press button [] to open the menu.
- Touch arrow key [>] repeatedly until the display shows "Home Connect".
- Touch [Home Connect Settings].
- Touch [Next].
- Touch [appliance Info]. The SSID, IP, MAC address and serial number of the appliance are displayed for a few seconds.

Display

The top right-hand corner of the display shows the Home Connect status with a symbol:



Connected to the network



Not connected to the network



No connection to server

Remote diagnostics

In the event of faults, customer service can use remote diagnostics to access your appliance. Contact customer service and ensure that your appliance is connected to the Home Connect server and check that the remote diagnostics service is available in your country.

For more information and to check whether the remote diagnostics service is available in your country, please visit the Help & Support area of the Home Connect website for your country: www.home-connect.com

Information on data protection

When the fully automatic coffee machine is connected for the first time to a WLAN network which is connected to the Internet, the appliance transmits the following categories of data to the Home Connect server (initial registration):

- Unique appliance identification (consisting of appliance codes as well as the MAC address of the installed Wi-Fi communication module).

- Security certificate of the Wi-Fi communication module (to ensure a secure IT connection).
- The current software and hardware version of the fully automatic coffee machine.
- Status of any previous resetting to the factory settings.

This initial registration prepares the Home Connect functions for use and is only required when you want to use these Home Connect functions for the first time.

i Please note that the Home Connect functions can only be used in conjunction with the Home Connect App. Information on data protection can be accessed in the Home Connect App.

Declaration of Conformity

BSH Hausgeräte GmbH hereby declares that the appliance which features Home Connect functionality is in accordance with the essential requirements and the other relevant provisions of the directive 2014/53/EU. A detailed RED Declaration of Conformity can be found online at www.siemens-home.bsh-group.com among the additional documents on the product page of your appliance.

2,4 GHz Band: 100mW max.

Care and daily cleaning



Risk of electric shock!

Never immerse the appliance in water. Do not steam-clean the appliance.

- Wipe the outside of the appliance with a soft, damp cloth.
- Clean the display using a micro-fibre cloth.
- Do not use any cleaning agents containing alcohol or spirits.

- Do not use abrasive cloths or cleaning agents.

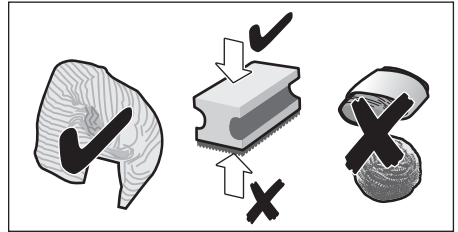

- Always remove any limescale, residues of coffee or milk, cleaning or descaling solution immediately. It is possible for corrosion to form underneath such deposits.

i New sponge cloths may contain salts. Salts can cause rust film on stainless steel and must therefore be washed out thoroughly before use.

- Open the door and pull the drip tray out forwards.
- Remove drip tray cover and coffee grounds container.
- Empty, clean and dry individual parts.

i **Important:** The drip tray and coffee grounds container should be emptied and cleaned every day in order to prevent deposits.

- Remove the ground coffee drawer, clean under running water and dry well.

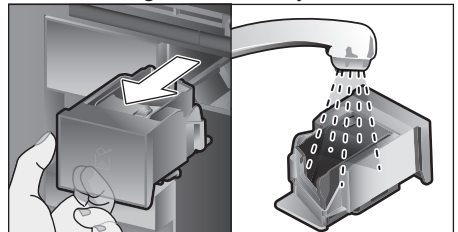

- Wipe and dry the inside of the appliance (support, drip tray and the ground coffee drawer) and collecting tray.
- Replace the dried parts, e.g. the ground coffee drawer.

 **Do not put the following parts in the dishwasher:**

Accessory drawer, water tank, lid of the water tank, beverage outlet cover, bean container, lid of the bean container, metal connecting element, ground coffee drawer, protective cover of the brewing unit and the milk container.

 **The following parts may be cleaned in the dishwasher:**

Drip plate, collecting tray, drip tray, drip tray cover, coffee grounds container, milk tubes, suction pipes, individual parts of the beverage outlet, measuring spoon and individual parts of the milk container lid.

 If the appliance is cold when switched on, or if it is switched off after dispensing coffee, it rinses automatically. The system is therefore self-cleaning.

 **Important:** If the appliance is not used for a lengthy period (e.g. while you are on holiday), clean the entire appliance thoroughly, including the milk system, the ground coffee drawer and the brewing unit before use.

Cleaning the milk system



The milk system is automatically cleaned with a short jet of steam directly after preparing a milk drink.

 **Tip:** For particularly thorough cleaning, the milk system can be additionally rinsed with water (see the section “Rinsing the milk system”).



Important: Clean the milk system manually every week and, if required, also more often (see the section “Cleaning the milk system manually”).

 **Risk of burns!**
The beverage outlet gets very hot. After use, always let it cool down before you touch it.

Rinsing the milk system

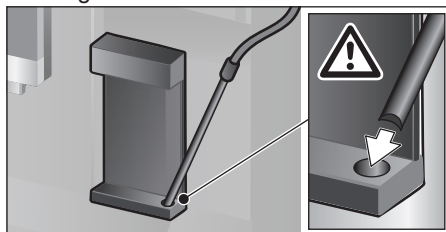
- Press button [] and select “Rinse milk system” with the rotary selector.
- Press [ / ] to start the programme.
- Open door and remove suction pipe from the milk tube.
- Wipe the suction pipe and insert the end of the suction pipe into the hole on the coffee grounds container.



- Close the door. Be careful not to jam the milk tube.
 - Place an empty glass underneath the beverage outlet.
 - Press button [ / ].
- The milk system is rinsed with water.
- Then empty the glass.
 - Press [] to exit the program.

Cleaning the milk system manually

Take the milk system apart to clean it:

- Push the beverage outlet down completely and pull the cover forward to remove.
- Press the snap lever to the left of the beverage outlet downwards and pull the beverage outlet forward.

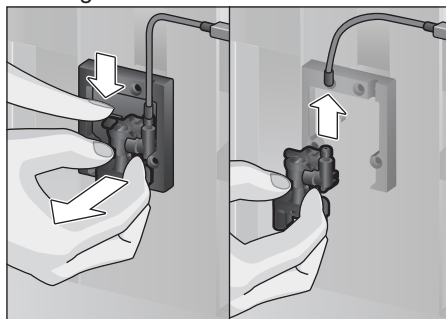

- Remove the milk tube. Dismantle the top and bottom sections of the beverage outlet.

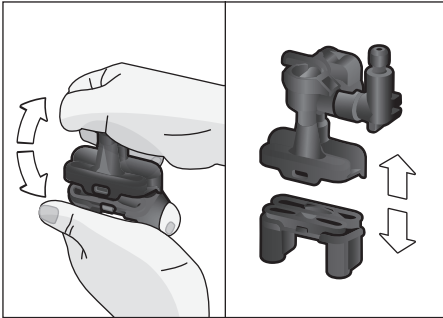

- Separate the milk tubes, connecting element and suction pipe.

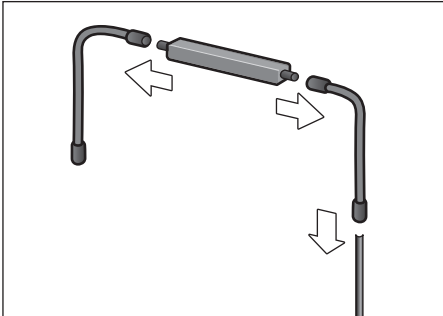

- Clean the individual parts with a detergent solution and a soft cloth.
- Rinse all parts with clean water and dry them.
- Put the individual parts back together again (see also the Quick reference guide).

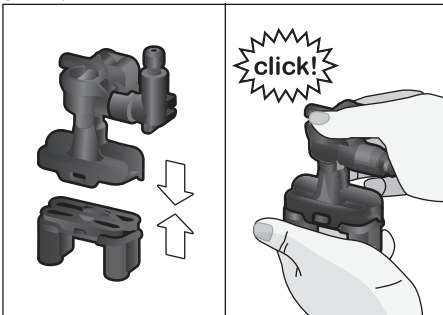

- Attach the beverage outlet directly from the front firmly to the three connections.
- Replace the cover.

Cleaning the milk container

For reasons of hygiene, the milk container should be cleaned regularly. Only the individual parts of the lid are suitable for being cleaned in the dishwasher. Clean the stainless steel milk container by hand with a mild detergent.

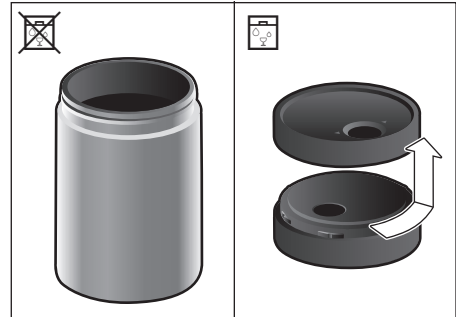

Cleaning the brewing unit

(see also the Quick reference guide)

In addition to the automatic cleaning programme, the brewing unit should be removed regularly for cleaning.

- Open the appliance door.
- Use the mains switch [O/I] to switch off the appliance completely.
- Remove the protective cover of the brewing unit.
- Remove the coffee grounds container.
- Slide the red latch on the brewing unit all the way to the left .
- Press the eject lever right down. The brewing unit will be released.
- Take hold of the brewing unit by the recessed grips and carefully remove it.
- Remove the cover of the brewing unit and clean thoroughly under running water.

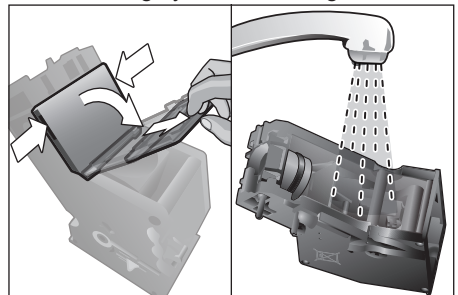

- Clean the strainer of the brewing unit thoroughly under the water jet.

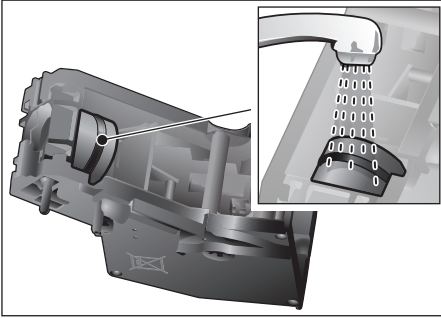

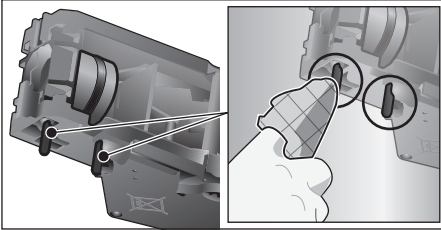

- Thoroughly clean the connecting nozzles of the brewing unit.



 **Important:** Clean it without using washing-up liquid and do not put it in the dishwasher.

- Clean the inside of the appliance thoroughly with a moist cloth, removing any coffee residues.
- Leave the brewing unit and the inside of the appliance to dry.
- Place the cover back on the brewing unit.
- Push the brewing unit all the way into the appliance and press on the middle until it audibly clicks into place.

 **Important:** The red latch must be right over at the left at  before replacing (see diagram E).

- Press the eject lever right up and push the red latch right over to the right to .
- Insert the coffee grounds container.
- Replace the protective cover.
- Close the appliance door.

Service programmes

(see also the Quick reference guide)

The following messages will appear on the display at certain intervals, either “Descaling programme urgently required!” or “Cleaning programme urgently required!” or “calc’nClean programme urgently required!”. The unit should immediately be cleaned or descaled using the appropriate programme. Alternatively, the two processes Descale and Clean can be carried out together using the calc’nClean function (see the section “calc’nClean”). Failure to carry out the service programme according to the instructions may damage the appliance.

 **Important:** If the appliance is not descaled when it is supposed to be, the message “Descaling programme is overdue. Device will shortly be locked.” will appear. Immediately perform the descaling process in accordance with the instructions. If the appliance is locked, it can only be operated again once the descaling process has been carried out.

To display how many beverages can still be prepared before one of the service programmes needs to be run, proceed as follows:

- Press button []
- Turn the rotary selector to select “Service info”.
- Touch [Display] to call up the information.

 **Warning!** For each of the service programmes, use descaling and cleaning agents as described in the instructions and observe the (relevant) safety information.

Never interrupt a service programme. Do not drink liquids!

Never use citric acid, vinegar or any vinegar-based agents to descale the appliance. Never place descaling tablets or other descaling materials in the ground coffee drawer!

**Important:**

Before starting each service program (Descale, Clean or calc'nClean) remove the brewing unit, clean as instructed and replace it.

Be careful not to jam the milk tube when closing the door.

After completion of each service programme, wipe the appliance immediately with a soft, damp cloth to remove any residues from the descaling and cleaning solution. It is possible for corrosion to form underneath such deposits.

New sponge cloths may contain salts. Salts can cause rust film on stainless steel and must therefore be washed out thoroughly before use. Clean the beverage outlet, milk tubes and connecting piece thoroughly.

Specially developed, suitable descaling and cleaning tablets are available from retail outlets or from customer services (see the section "Accessories").



Using a water filter increases the intervals until a descaling programme needs to be performed.

Descaling

Takes about 21 minutes.

- Press button [].
- Turn the rotary selector to select "Descale".
- Press button [/]. Display indicates progress of the programme.
- Empty drip trays and replace.
- Remove water filter(if there is one) and press [/].
- Pour lukewarm water into the empty water tank up to the "0.5 l" mark and then dissolve one Siemens descaling tablet TZ80002 in it.



If there is not enough descaling solution in the water tank, you will be asked to do the following. Refill using uncarbonated water and press [/] again.

- Remove the suction pipe from milk container, wipe it and insert the end of the suction pipe into the hole on the coffee grounds container.
- Close the appliance door.
- Place a container with a capacity of 0.5 litre under the beverage outlet.
- Press button [/]. The descaling programme will now run for about 19 minutes.
- Remove the container and press [/].
- Rinse the water tank and (if removed) replace the water filter.
- Fill the tank with fresh water up to the "max" indicator.
- Replace the water tank and close the door.
- Place the container underneath the beverage outlet again.
- Press button [/]. The descaling programme will now run for about 2 minutes and rinse the appliance.
- Remove the container, empty the drip trays, replace and close the appliance door.
- Press [/]. The appliance has finished descaling and is ready for use again.
- Press [] to exit the program.

Cleaning

Takes about 5 minutes.

- Press button [].
- Turn the rotary selector to select "Clean".
- Press button [/]. Display indicates progress of the programme.
- Clean the beverage outlet and replace, empty the drip trays and replace.
- Open the ground coffee drawer, drop in a cleaning tablet and close the coffee drawer again.
- Close the appliance door.

- Place a container with a capacity of 0.5 litre under the beverage outlet.
- Press button [▷/□]. The cleaning programme will now run for about 5 minutes.
- Remove the container, empty the drip trays, replace and close the appliance door.
- Press [▷/□]. The appliance has finished cleaning and is ready for use again.
- Press [⏏] to exit the program.

calc'nClean

Takes about 26 minutes.

calc'nClean combines the functions Descale and Clean. If both programmes are due to be carried out close together, the fully automatic coffee machine will automatically suggest this service programme.

- Press button [⏏].
- Turn the rotary selector to select "calc'nClean".
- Press button [▷/□]. The display indicates the progress of the programme.
- Clean the beverage outlet and replace, empty the drip trays and replace.
- Open the ground coffee drawer, drop in a cleaning tablet and close the coffee drawer again.
- Remove the water filter (if there is one) and press [▷/□].
- Pour lukewarm water into the empty water tank up to the "0.5 l" mark and then dissolve one Siemens descaling tablet TZ80002 in it.

i If there is not enough descaling solution in the water tank, you will be asked to do the following. Refill using uncarbonated water and press [▷/□] again.

- Remove the suction pipe from milk container, wipe it and insert the end of the suction pipe into the hole on the coffee grounds container.
- Close the appliance door.
- Place a container with a capacity of 0.5 litre under the beverage outlet.
- Press button [▷/□].

The programme will now run for about 19 minutes.

- Remove the container and press [▷/□].
- Rinse the water tank and (if removed) replace the water filter.
- Fill the tank with fresh water up to the "max" indicator.
- Replace the water tank and close the door.
- Place the container underneath the beverage outlet again.
- Press button [▷/□].

The programme will now run for about 7 minutes and rinse the appliance.

- Remove the container, empty the drip trays, replace and close the appliance door.
- Press [▷/□]. The appliance is descaled, cleaned and ready for use again.
- Press [⏏] to exit the program.

Special rinsing

i Important: If any of the service programmes is ever interrupted, for instance by a power failure, please proceed according to the information on the display:

- Rinse the water tank and refill it with fresh water up to the "max" mark.
- Press button [▷/□]. The programme will now run for about 2 minutes and rinse the appliance.
- Empty the drip trays, replace and close the appliance door. The appliance is ready for use again.
- Press [⏏] to exit the program.

Tips on energy saving

- Press button [⏻] to switch the appliance to “energy saving mode”. The appliances uses very little power when in “energy saving mode”, but monitors all safety-relevant functions so as to avoid damage.
- In the menu under “Switch off after”, set the automatic switch off period to 15 minutes.
- Reduce the brightness of the display and the illumination in the menu to save energy.
- If possible, do not interrupt the dispensing of coffee or milk froth. Stopping a process prematurely results in higher energy consumption and the drip tray fills up more quickly.
- Descale the appliance regularly to avoid a build-up of limescale. Limescale residues cause higher energy consumption.

Frost protection

To prevent frost damage during transport and storage, completely empty the appliance beforehand (see the section “Menu – Frost protection”).

Storing accessories

The fully automatic coffee machine has a special accessory drawer for storing the Quick reference guide and the accessories in the appliance.

- Put the measuring spoon and the water filter into the accessory drawer.
- Put the Quick Reference Guide into the special support at the front of the accessory drawer.
- The long suction pipe can be stored in the holder on the inside of the door.
- The connecting element can be fixed to the magnetic holder above the ground coffee drawer.

Accessories

The following accessories are available from retailers or from customer service:

Accessories	Order number
	Customer service
Cleaning tablets	00311807
Descaling tablets	00576693
Water filter	00575491
Care set	00576330
Milk container with “freshLock” lid	00576166
Restrictors for opening angle 92°	00636455

Disposal



Dispose of packaging in an environmentally-friendly manner. This appliance is labelled in accordance with European Directive 2012/19/EU concerning used electrical and electronic appliances (waste electrical and electronic equipment – WEEE). The guideline determines the framework for the return and recycling of used appliances as applicable throughout the EU. Please ask your specialist retailer about current disposal facilities.

Guarantee

The guarantee conditions for this appliance are as defined by our representative in the country in which it is sold. Details regarding these conditions can be obtained from the dealer from whom the appliance was purchased. The bill of sale or receipt must be produced when making any claim under the terms of this guarantee.

Changes reserved.

Simple troubleshooting

Problem	Cause	Solution
Strongly fluctuating coffee or milk froth quality (e.g. fluctuation in quantity or milk froth spraying).	Build-up of limescale in the appliance.	Descalcify the appliance according to the instructions, see the section "Service programmes".
	The suction pipe is blocked.	Clean the suction pipe.
Drinks cannot be dispensed.	Beverage outlet or one of the 3 connections are blocked.	Clean the beverage outlet and the connections.
The drink runs out at the entire outlet during dispensing.	Lower part of the beverage outlet is missing.	Attach the lower part, see the section "Cleaning the milk system".
Too little milk froth, none at all, or the milk system is not taking in any milk.	Build-up of limescale in the appliance.	Descalcify the appliance according to the instructions, see the section "Service programmes".
	Beverage outlet or one of the 3 connections are blocked.	Clean the beverage outlet and the connections.
	Milk not suitable for foaming.	Do not use milk that has already been boiled. Use cold milk with a fat content of at least 1.5%.
	Beverage outlet or the milk tubes are not correctly assembled.	Moisten the individual parts and put them together again.
	The suction pipe is blocked.	Clean the suction pipe.
The personally selected volume is not reached. Coffee dispensing slows to a trickle or stops completely.	Coffee is ground too finely. Preground coffee is too fine.	Adjust the grinding level to a coarser setting. Use a coarser ground coffee.
	Heavy build-up of limescale in the appliance.	Descalcify the appliance according to the instructions, see the section "Service programmes".
	The brewing unit is soiled.	Clean brewing unit, see chapter "Cleaning the brewing unit".
Hot water milky or tastes of coffee.	Milk tube has not been removed.	Remove the milk tube from the milk container.
	Milk or coffee residue in the beverage outlet.	Clean the beverage outlet.
Coffee has no "crema".	Unsuitable type of coffee.	Use a type of coffee with a higher proportion of robusta beans.
	The beans are no longer fresh.	Use fresh beans.
	The grinding level is not suitable for the beans.	Adjust the grinding unit to a finer setting.

Problem	Cause	Solution
Coffee is too "acidic".	The grinding level is too coarse. Preground coffee is too coarse.	Adjust the grinding unit to a finer setting. Use a finer ground coffee.
	Unsuitable type of coffee.	Change the type of coffee.
Coffee is too "bitter".	Coffee is ground too finely. Preground coffee is too fine.	Adjust the grinding level to a coarser setting. Use a coarser ground coffee.
	Unsuitable type of coffee.	Change the type of coffee.
Coffee tastes burnt.	The brewing temperature is too high.	Reduce the temperature, see the section "Drink adjustment".
	Coffee is ground too finely. Preground coffee is too fine.	Adjust the grinding level to a coarser setting. Use a coarser ground coffee.
	Unsuitable type of coffee.	Change the type of coffee.
Coffee is too "weak".	Coffee strength selected is too weak.	Raise the strength of the coffee, see the section "Drink adjustment".
	Ground coffee jammed in the coffee drawer.	Remove the ground coffee drawer, clean and dry thoroughly.
Ground coffee sticks in the coffee drawer.	Ground coffee sticks together.	Do not press the ground coffee firmly into the coffee drawer.
	Coffee drawer is damp.	Remove the ground coffee drawer, clean and dry thoroughly.
The water filter does not stay in position in the water tank.	The water filter is not mounted correctly.	Firmly press the water filter straight down into the tank connection.
Bean container sticks when inserting.	There are beans in the housing.	Remove the beans.
The coffee grounds are not compact and are too wet.	The grinding setting is too fine or too coarse, or not enough ground coffee has been used.	Adjust the grinding unit to a coarser or finer setting, or use 2 level measuring spoons of ground coffee.
Grinding level adjustment is stiff.	Too many beans in the grinding unit.	Dispensing a drink from coffee beans. Only make any subsequent changes to the grinding level in small steps.
Brewing unit cannot be inserted.	Brewing unit is in the wrong position.	Insert the brewing unit according to the instructions, see the section "Cleaning the brewing unit".
	Brewing unit is locked.	Unlock the brewing unit, see the section "Cleaning the brewing unit".

Problem	Cause	Solution
Protective cover of the brewing unit cannot be properly attached.	Brewing unit is not locked.	Lock the brewing unit, see the section "Cleaning the brewing unit".
There is water under the drip tray.	This water is condensed.	Do not insert drip tray without cover.
Display shows "12:00"	Power failure or appliance switched off at mains.	Re-enter values; do not switch the appliance off at the mains or select the "Off" option in the Clock display menu.
Display shows "Milk container connected?" despite connected milk container.	Container is outside the range of the sensor.	Position the container at the right edge.
	Material e.g. milk carton is not recognised.	Confirm the display request with "Yes" or use the enclosed milk container.
Display shows "Overvoltage or undervoltage"	Voltage too high or too low.	Contact electricity or grid provider. Have the power supply checked by an expert.
Display shows "Leave device to cool"	Appliance is too hot.	Switch off appliance for 30 minutes.
Display shows, for example: "Fault: E0510"	The appliance has a fault.	Proceed according to the display screen.
Display shows "Fill bean container" although the container is already full, or the grinder is not grinding any beans.	Beans are not falling into the grinding unit (beans too oily).	Gently tap the bean container. Possibly change the type of coffee. When the bean container is empty, wipe it with a dry cloth.
Display shows "Clean brewing unit"	Brewing unit is soiled.	Clean the brewing unit.
	Too much ground coffee in the brewing unit.	Clean the brewing unit. Do not place more than two level measuring spoons of ground coffee in the drawer.
	The mechanism of the brewing unit is stiff.	Clean the brewing unit, see the section "Care and daily cleaning".
Display shows "Refill with still water or remove filter"	Water tank wrongly inserted	Insert water tank correctly
	Carbonated water in the water tank.	Fill the water tank with fresh tap water.
	Float is stuck in the water tank.	Remove the tank and clean thoroughly.
	New water filter not rinsed according to instructions, or water filter used or defective.	Rinse the water filter according to the instructions and then switch on, or use a new water filter
	Air in the water filter.	Dip the water filter into water until no more air bubbles escape, replace the filter.

Problem	Cause	Solution
Display shows "Empty drip trays" despite them being empty.	Drip tray is soiled and wet.	Clean and dry the drip tray thoroughly.
	Emptying is not detected when the appliance is switched off.	When the appliance is switched on, remove and re-insert the drip tray.
Display shows "Insert drip trays" even though drip tray in use.	Inside of appliance (tray holder) dirty.	Clean the inside.
	The coffee grounds container is not fully inserted.	Push the coffee grounds container all the way in.
Very frequent display that descaling is necessary.	Water is too hard.	Insert water filter and configure settings accordingly in the menu.
Water dripped onto the inner floor of the appliance when the drip tray was removed.	Drip tray was removed too soon.	Wait a few seconds after the last drink was dispensed before removing the drip tray.
Display shows "Please open door, switch off with power switch and then back on after 30 sec!"	Appliance is too warm.	Leave the appliance to cool down.
	Dirty brewing unit.	Clean the brewing unit.
Home Connect does not work correctly.		Go to www.home-connect.com

If you are unable to solve the problem, always call the hotline!

You will find the telephone numbers at the back of these instructions.

Technical specifications

Power connection (voltage – frequency)	220-240 V – 50/60 Hz
Power rating	1600 W
Maximum static pump pressure	19 bar
Maximum water tank capacity (without filter)	2.4 l
Maximum capacity of the coffee bean container	500 g
Length of power cable	1.7 m
Dimensions (H x B x D)	455 x 495 x 375 mm
Weight, empty	19-20 kg
Type of grinding unit	Ceramic

DE Deutschland, Germany
BSH Hausgeräte Service GmbH
Zentralwerkstatt für kleine Hausgeräte
Trautskirchener Strasse 6-8
90431 Nürnberg
Online Auftragsstatus, Pickup Service
für Kaffeevollautomaten und viele
weitere Infos unter:
www.siemens-home.bsh-group.de
Reparaturservice, Ersatzteile &
Zubehör, Produkt-Informationen:
Tel.: 0911 70 440 044
<mailto:cp-servicecenter@bshg.com>
Wir sind an 365 Tagen rund um die Uhr
erreichbar.

AE United Arab Emirates,
الإمارات العربية المتحدة
BSH Home Appliances FZE
Round About 13, Plot Nr MO-0532A
Jebel Ali Free Zone – Dubai
Tel.: 04 881 4401
<mailto:service.uae@bshg.com>
www.siemens-home.bsh-group.com/ae

AT Österreich, Austria
BSH Hausgeräte Gesellschaft mbH
Werkskundendienst für Hausgeräte
Quellenstrasse 2a
1100 Wien
Online Reparaturannahme,
Ersatzteile und Zubehör und
viele weitere Infos unter:
www.siemens-home.bsh-group.at
Reparaturservice, Ersatzteile &
Zubehör, Produktinformationen
Tel.: 0810 550 522
<mailto:vie-stoerungsannahme@bshg.com>
Wir sind an 365 Tagen rund um die Uhr für
Sie erreichbar.

AU Australia
BSH Home Appliances Pty. Ltd.
Gate 1, 1555 Centre Road
Clayton, Victoria 3168
Tel.: 1300 167 425*
Fax: 1300 306 818
mailto:aftersales.au@bshg.com
www.siemens-home.bsh-group.com/au
* Mo-Fr: 24 hours

BA Bosna i Hercegovina,
Bosnia-Herzegovina
"HIGH" d.o.o.
Gradačanka 29b
71000 Sarajevo
Tel.: 061 10 09 05
Fax: 033 21 35 13
[mailto:bosch_siemens_sarajevo@
yahoo.com](mailto:mailto:bosch_siemens_sarajevo@yahoo.com)

BE Belgique, België, Belgium
BSH Home Appliances S.A. – N.V.
Avenue du Laerbeek 74
Laarbeeklaan 74
1090 Bruxelles – Brussel
Tel.: 02 475 70 02
mailto:bru-repairs@bshg.com
www.siemens-home.bsh-group.com/be

BH Bahrain, مملكة البحرين
Khalaifat Est.
P.O. Box 5111
Manama
Tel.: 01 7400 553
mailto:service@khalaifat.com

BY Belarus, Беларусь
ООО "БСХ Бытовая техника"
тел.: 495 737 2962
mailto:mok-kdhl@bshg.com

CH Schweiz, Suisse,
Svizzera, Switzerland
BSH Hausgeräte AG
Siemens Hausgeräte Service
Fahrweidstrasse 80
8954 Geroldswil
Reparaturservice, Ersatzteile &
Zubehör, Produktinformationen
Tel.: 0848 888 500
Service Fax: 0848 840 041
mailto:ch-reparatur@bshg.com
Ersatzteile & Zubehör
Fax: 0848 880 081
mailto:ch-ersatzteil@bshg.com
www.siemens-home.bsh-group.com/ch

CY Cyprus, Κύπρος
BSH Ikiakes Syskeves-Service
39, Arh. Makaanariou III Str.
2407 Egomi/Nikosia (Lefkosia)
Tel.: 7777 8007
Fax: 022 65 81 28
[mailto:bsh.service.cyprus@
cytanet.com.cy](mailto:mailto:bsh.service.cyprus@cytanet.com.cy)

CZ Česká Republika,
Czech Republic
BSH domácí spotřebiče s.r.o.
Firemní servis domácích spotřebičů
Radlická 350/107c
158 00 Praha 5
Tel.: 0251 095 546
www.siemens-home.bsh-group.com/cz

DK Danmark, Denmark
BSH Hvidevarer A/S
Telegrafvej 4
2750 Ballerup
Tel.: 44 89 80 28
BSH-Service.dk@bshg.com
www.siemens-home.bsh-group.com/dk

ES España, Spain

En caso de avería puede ponerse en contacto con nosotros, su aparato será trasladado a nuestro taller especializado de cafeteras.

BSH Electrodomésticos España S. A.
Servicio Oficial del Fabricante
Parque Empresarial PLAZA,
C/ Manfredonia, 6
50197 Zaragoza
Tel.: 976 305 714
Fax: 976 578 425
mailto:CAU-Siemens@bshg.com
www.siemens-home.bsh-group.es

FI Suomi, Finland

BSH Kodinkoneet Oy
Itälahdenkatu 18 A
PL 123
00201 Helsinki
Tel.: 0207 510 715
mailto:Siemens-Service-FI@bshg.com
www.siemens-home.bsh-group.com/fin
Solttajahinta on kiinteästä verkosta ja
matkapuhelimesta 8,35 snt/puh + 16,69 snt/min.

FR France

BSH Electroménager S.A.S.
50 rue Ardoin – CS 50037
93406 SAINT-OUEN cedex
Service interventions à domicile:
01 40 10 12 00

Service Consommateurs:

0 892 698 110 Service 0,40 € / min
+ prix appel

mailto:serviceconsommateur.fr@
siemens-home.bsh-group.com
Service Pièces Détachées et
Accessoires:

0 892 698 009 Service 0,40 € / min
+ prix appel

www.siemens-home.bsh-group.fr

GB Great Britain

BSH Home Appliances Ltd.
Grand Union House
Old Wolverton Road
Wolverton
Milton Keynes MK12 5PT
To arrange an engineer visit, to order
spare parts or accessories or for
product advice please visit
www.siemens-home.bsh-group.com/uk
Or call
Tel.: 0344 892 8999*

* Calls are charged at the basic rate,
please check with your telephone service
provider for exact charges.

HK Hong Kong, 香港

BSH Home Appliances Limited
Unit 1 & 2, 3rd Floor,
North Block, Skyway House,
3 Sham Mong Road
Tai Kok Tsui, Kowloon
Hong Kong
Tel.: 2565 6151
Fax: 2565 6681
mailto:siemens.hk.service@bshg.com
www.siemens-home.bsh-group.com/hk

IE Republic of Ireland

BSH Home Appliances Ltd.
M50 Business Park
Ballymount Road Upper
Walkinstown
Dublin 12
To arrange an engineer visit, to order
spare parts and accessories or for
product advice please call
Tel.: 01450 2655*
www.siemens-home.bsh-group.ie

* Calls are charged at the basic rate, please
check with your telephone service provider
for exact charges.

IL Israel, ישראל

C/S/B/ Home Appliance Ltd.
1, Hamasger St.
North Industrial Park
Lod, 7129801
Tel.: 08 9777 222
Fax: 08 9777 245
mailto:csb-serv@csb-ltd.co.il
www.siemens-home.bsh-group.com/il

IN India, Bhārat, भारत

BSH Household Appliances
Mfg. Pvt. Ltd.
Arena House,
Main Bldg, 2nd Floor,
Plot No. 103, Road No. 12,
MIDC, Andheri East
Mumbai 400 093
Toll Free 1800 209 1850*
www.siemens-home.bsh-group.com/in
* Mo-Sa: 8.00am to 8.00pm
(exclude public holidays)

IS Iceland

Smith & Norland hf.
Noatuni 4
105 Reykjavik
Tel.: 0520 3000
Fax: 0520 3011
www.sminor.is

IT Italia, Italy

BSH Elettrodomestici S.p.A.
Via. M. Nizzoli 1
20147 Milano (MI)
Numero verde 800 018 346
mailto:info.it@siemens-home.
bsh-group.com
www.siemens-home.bsh-group.com/it

LB Lebanon, لبنان

Tehaco s.a.r.l.
Boulevard Dora 4043 Beyrouth
P.O. Box 90449
Jdeideh, 1202 2040
Tel.: 01 255 211
mailto:Info@Teheni-Hana.com

LU Luxembourg

BSH électroménagers S.A.
13-15, ZI Breedeweues
1259 Senningerberg
Tel.: 26 349 821
Fax: 26 349 315
Reparaturen: lux-repair@bshg.com
Ersatzteile: lux-spare@bshg.com
www.siemens-home.bsh-group.com/lu

MK Macedonia, Македонија

GORENEC
Jane Sandanski 69 lok. 3
1000 Skopje
Tel.: 02 2454 600
Mobil: 070 697 463
mailto:gorenece@yahoo.com

MT Malta

Aplan Limited
The Atrium
Mriehel by Pass
BKR3000 Birkirkara
Tel.: 025 495 122
Fax: 021 480 598
mailto:lapap@aplan.com.mt

NL Nederlande, Netherlands

BSH Huishoudapparaten B.V.
Taurusavenue 36
2132 LS Hoofddorp
Storingsmelding:
Tel.: 088 424 4020
Fax: 088 424 4845
mailto:siemens-contactcenter@
bshg.com
Onderdelenverkoop:
Tel.: 088 424 4020
Fax: 088 424 4801
mailto:siemens-onderdelen@bshg.com
www.siemens-home.bsh-group.nl

NO Norge, Norway

BSH Husholdningsapparater A/S
Grensesvingen 9
0661 Oslo
Tel.: 22 66 05 73
Fax: 22 66 06 00
mailto:Siemens-Service-NO@bshg.com
www.siemens-home.bsh-group.com/no

PL Polska, Poland

BSH Sprzęt Gospodarstwa
Domowego sp. z o.o.
Al. Jerozolimskie 183
02-222 Warszawa
Tel.: 801 191 534
Fax: 022 572 7709
mailto:Serwis.Fabryczny@bshg.com
www.siemens-home.bsh-group.pl

PT Portugal

BSHP Electrodomésticos,
Sociedade Unipessoal, Lda.
Rua Alto do Montijo, nº 15
2790-012 Carnaxide
Tel.: 214 250 720
Fax: 214 250 701
mailto:siemens.electrodomesticos.pt@
bshg.com
www.siemens-home.bsh-group.com/pt

RO România, Romania

BSH Electrocasnice srl.
Sos. Bucuresti-Ploiesti,
nr. 19-21, sect.1
13682 Bucuresti
Tel.: 021 203 9748
Fax: 021 203 9733
mailto:service.romania@bshg.com
www.siemens-home.bsh-group.com/ro

RU Russia, Россия

ООО "БСХ Бытовые Приборы"
Сервис от производителя
Малая Калужская, 15
119071 Москва
тел.: 8 (800) 200 29 62
mailto:mok-kdhl@bshg.com
www.siemens-home.bsh-group.ru

SE Sverige, Sweden

BSH Home Appliances AB
Landsvägen 32
169 29 Solna
Tel.: 0771 19 55 00 local rate
Tel.: 0771 11 22 77 local rate
mailto:Siemens-Service-SE@bshg.com
www.siemens-home.bsh-group.com/se

SK Slovensko, Slovakia

BSH domácí spotřebiče s.r.o.
Firemní servis domácích spotřebičů
Radlická 350/107c
158 00 Praha 5
Tel.: +421 244 452 041
mailto:opravy@bshg.com

TR Türkiye, Turkey

BSH Ev Aletleri Sanayi
ve Ticaret A.S.
Fatih Sultan Mehmet Mahallesi
Balkan Caddesi No: 51
34771 Ümraniye, İstanbul
Tel.: 0 216 444 6688*
Fax: 0 216 528 9188*
mailto:careline.turkey@bshg.com
www.siemens-home.bsh-group.com/tr
* Çağrı merkezini sabit hatlardan
aramanın bedeli şehir içi ücretlendirme,
Cep telefonlarından ise kullanılan
tarifeye göre değişiklik göstermektedir

UA Ukraine, Україна

ТОВ "БСХ Побутова Техніка"
тел.: 044 490 2095
mailto:bsh-service.ua@bshg.com
www.siemens-home.bsh-group.com/ua

XK Kosovo

SERVICE-GENERAL SH.P.K.
Rruga Mag Prishtine-Ferizaj
70000 Ferizaj
Tel.: 0290 321 434
Tel.: 0290 330 723
mailto:a_service@
gama-electronics.com

ZA South Africa

BSH Home Appliances (Pty) Ltd.
15th Road Randjespark
Private Bag X36, Randjespark
1685 Midrand – Johannesburg
Tel.: 086 002 6724
Fax: 086 617 1780
mailto:applianceserviceza@bshg.com
www.siemens-home.bsh-group.com/za

Service-Hotlines

www.siemens-home.bsh-group.com

AE	04 803 0501	LI	05 274 1788
AL	066 206 47 94	LU	26 349 300
AT	0810 550 522	LV	067 425 232
AU	1300 368 339	ME	050 432 575
BA	033 213 513	MK	02 2454 600
BE	070 222 142	NL	088 424 4020
BG	02 931 50 62	NO	22 66 06 00
CH	043 455 4095	PL	801 191 534
CN	400 889 9999 Call rates depend on the network used	PT	21 4250 720
CZ	0251 095 546	RO	021 203 9748
DE	0911 70 440 044	RU	8 800 200 29 62
DK	44 89 89 85	SE	0771 11 22 77 (local rate)
EE	0627 8730	SK	02 444 520 41
ES	902 11 88 21	SL	01 200 70 17
FI	020 7510 700 Lankapuhelimesta 8,28 snt/puhelu + 7 snt/min (alv 24%) Matkapuhelimesta 8,28 snt/puhelu + 17 snt/min (alv 24%)	TR	444 6688 Çağrı merkezini sabit hatlardan aramanın bedeli şehir içi ücretlendirme, Cep telefonlarından ise kullanılan tarifeyle göre değişkenlik göstermektedir
FR	0140 10 1200	US	866 447 4363 (toll free)
GB	0344 892 8999 Calls charged at local or mobile rate	XK	044 172 309
GR	18 182 (Αστική χρέωση)	XS	011 21 39 552
HR	01 3028 226		
HU	0036 1 489 5461		
IE	01450 2655 0.03 € per minute at peak. Off peak 0.0088 € per minute.		
IL	08 9777 222		
IS	0520 3000		
IT	800 018 346 (Line Verde)		

BSH group is a Trademark Licensee of Siemens AG. Manufacturer's Service for Siemens Home Appliances.

由博西家用电器（中国）有限公司根据西门子股份公司的商标许可制造

Manufactured by BSH Hausgeräte GmbH under Trademark License of Siemens AG

BSH Hausgeräte GmbH
Carl-Wery-Straße 34
81739 München, GERMANY

Reparaturauftrag und Beratung bei Störungen

DE 0911 70 440 044
AT 0810 550 522
CH 0848 840 040

Die Kontaktdaten aller Länder finden Sie im
beiliegenden Kundendienst-Verzeichnis.

www.siemens-home.bsh-group.cn



8001110275
(9804)