

Instruction Manual and Installation Instructions

en

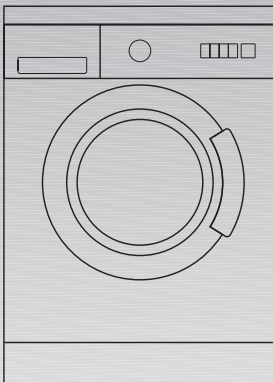

Washing Machine

Table of Contents

Operating Instructions

Information concerning waste disposal	5
Disposing of the packaging	5
Disposing of your old appliance	5
Protection of the environment / Hints and tips . .	6
General safety instructions	7
Introducing your washing machine	8
Control panel	9
Display panel	10
Before using your washing machine for the first time	13
Preparing your washing machine	13
Preparing, sorting and loading the washing	14
Preparing the washing	14
Sorting the washing	15
Degrees of dirt	15
Loading the washing	18
Detergents and cleaning products	19
Dosing detergent	19
Adding detergent/cleaning product	20
Programmes and functions	21
Programme selector	21
Additional option – buttons	23
Washing with standard settings	25
Washing with individual settings	27
Overview at a glance	27
Spin speed	28
Start time	29
Childproof lock	31
During washing	32
Changing the programme	32
Cancelling the programme	33

After washing	34
Removing the washing	35
Special applications	36
Soaking	36
Starching	36
Dyeing	37
Bleaching	37
Cleaning and Care	38
Clean housing, fascia and supply lines	38
Cleaning the drum	38
Cleaning the detergent dispenser	39
Cleaning the drain pump	40
Cleaning water inlet strainers	42
Descaling the washing machine	43
Help with minor problems	44
Fault displays	44
Consumption values	49
Customer service	50
Installing, connecting and transporting the appliance	51
Safety instructions	51
Standard accessories	52
Dimensions	53
Installation surface	53
Removing the transport bolts	54
Hose and cable lengths	56
Connecting the water	57
Aligning the washing machine	59
Connecting the power	60
Transport, e.g. when moving	61
Index	62

Installation Instructions

Appendix

The new washing machine which you have just purchased is a modern, high-quality domestic appliance.

Your washing machine is distinguished by its economical consumption of energy, water and detergent.

Each washing machine which leaves our factory is checked carefully to ensure that it functions properly and is in perfect condition. If you have any questions – especially with respect to installing and connecting your washing machine – please do not hesitate to contact our customer service department.

Further information and a selection of our products can be found on our Internet page:
<http://www.siemens.de/hausgeraete>

Please read these operating and installation instructions and all other information enclosed with the washing machine and act accordingly.

These operating and installation instructions describe various models. Differences are indicated in the appropriate places.

Retain all documentation for subsequent use or for the next owner of the appliance.

Information concerning waste disposal

Disposing of the packaging

The shipping package has protected your new appliance on its way to your home. All utilised materials are ecologically harmless and recyclable. Please contribute to a better environment by disposing of packaging materials in an environmentally conscious manner.

Please ask your dealer or inquire at your local authority about current means of disposal.

⚠ Risk of choking!

Do not let children play with packaging and associated parts. Risk of choking on plastic film and collapsible cardboard boxes.

Disposing of your old appliance

Old appliances are not worthless rubbish! Environment-conscious recycling can reclaim valuable raw materials.

⚠ Danger of death!

Unplug mains plug on redundant appliances. Cut off mains cable and discard with mains plug.

Destroy the lock on the door. To prevent playing children from becoming trapped and endangered, ensure that the door locking mechanism is disabled.

Protection of the environment / Hints and tips

Your washing machine uses water, energy and detergent efficiently, thereby protecting the environment and reducing your household costs. See Page 49 for consumption values of your appliance.

Hints and tips

Using your washing machine in an efficient and environmentally friendly manner:

- Take advantage of recommended load quantity. The recommended load quantity is indicated in the display field according to the selected programme. With smaller amounts of laundry, the load adjust reduces the water and energy consumption.
- Select the **Cottons/Coloureds 60 °C Stains** programme instead of **Cottons/Coloureds 90 °C**. The longer washing time in this 60 °C programme means that the cleaning effects are comparable with those of a 90 °C programme, although the power consumption is considerably lower.
- Do not use prewash for lightly to normally soiled washing.
- Add detergent according to the degree of soiling, amount of laundry and water hardness, and observe the detergent manufacturer's instructions.
- If washing is then to be dried in the tumble dryer, select spin speed in accordance with the instructions supplied by the dryer manufacturer.

General safety instructions

Your washing machine is intended for

- use in the household only,
- For washing machine-washable fabrics in washing lye.
- operation with cold drinking water and commercially available detergents and cleaning products which are suitable for use in washing machines.

Do not leave children unsupervised near the washing machine.

Keep pets away from the washing machine.

Do not insert/pull out the mains plug with wet hands.

Do not pull out the mains plug by tugging the cable.

Do not touch the loading door when washing at high temperatures.

Caution when draining hot water.

Do not climb onto the washing machine.

Do not lean on the open washing machine door.

Introducing your washing machine

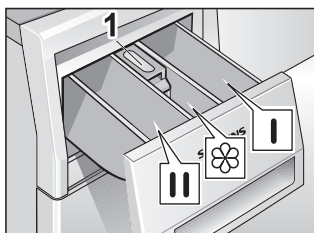

Adding detergent/cleaning product

Dispenser I:

Detergent for prewash or starch.

Dispenser II:

Detergent for main wash, soaking agent, water softener, bleach or stain remover.

Dispenser :

Cleaning product, e.g. fabric softener or fabric conditioner (do not fill above the lower edge of the insert **1**).

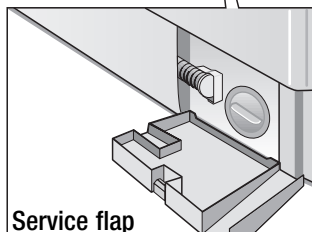
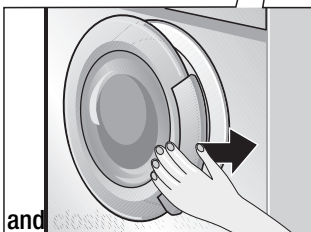
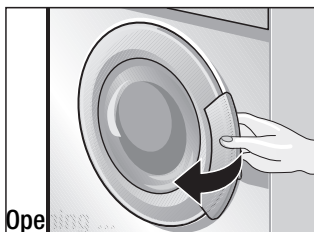
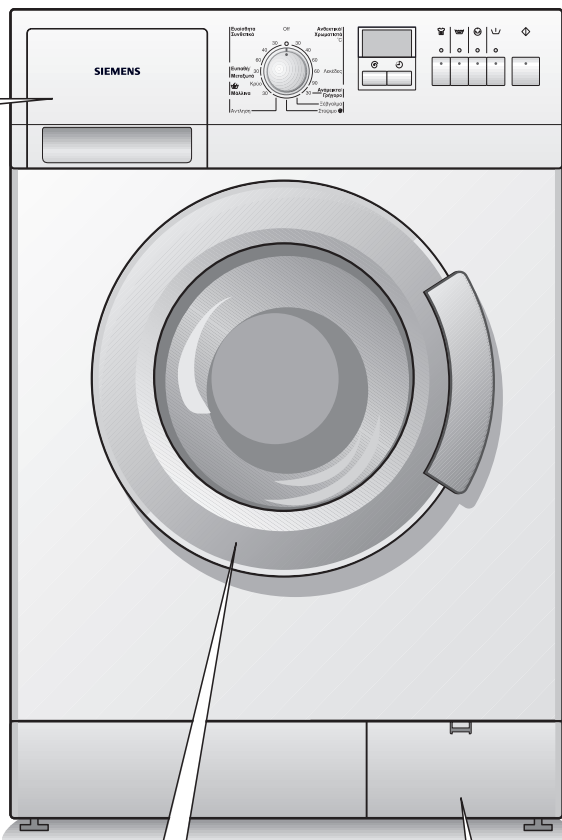

Control panel

Programme selector

For switching the machine on and off and for selecting the programme.

Can be rotated in either direction.

The programme selector does not rotate while the programme is running the programme sequence is electronically controlled.

◊ button

For starting the wash cycle (programme must have been selected).

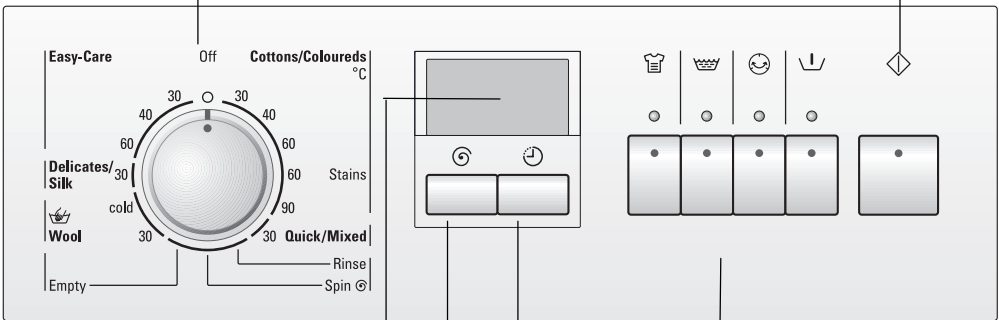

Display panel

Indicates the settings which have been selected (e.g. spin speed, Time delay, Childproof lock, Recommended load) as well as programme progress.

Button





Selects the spin speed or no final spin.

Button

Selects the start time (delays the start of the programme).

Buttons for additional options

(in addition to the programme if required)

- : Intensive wash
- : Additional rinsing cycle
- : Gentle spin
- : actuate Prewash

Additional options can be combined.

The indicator lights of the buttons come on, if the additional options are active.

Switching off the additional option: Press the button again. Indicator light goes out.

Display panel

Programme status display



Display	Notes
Prewash	On if selected
Washing	Not on if rinse, spin or empty additional programme was selected
Rinse	Not on if spin or empty additional programme was selected
Final spin / Empty	Not on if a programme with the "----" setting (without final spin) is running
Progress bar	For the programme status
Overdosage	On if too much detergent dispensed
Childproof lock	On if selected
6.0kg* Recommended load	Not on if rinse, spin or empty additional programme was selected
1200* Spin speed or ----* no final spin	Maximum spin speed of the programme or selected speed
1:17* Programme duration	Expected programme duration
Other displays at this location:	
1'h* Start time,	Selected start time
-0- End of programme or ---- end of programme without final spin or	
F02* Fault displays	See Page 44

* Examples of the display

Programme status display

The first row of symbols and the progress bar below form the programme status display. The progress bar consists of a frame and several segments.

When the programme has been selected, the symbols for the individual programme sections are displayed.

The frame of the progress bar flashes and requests the programme to start.

When the programme has started, the almost empty bar is displayed which fills up with segments from left to right while the programme is running.



The symbols indicate the programme sections which have not yet run and go out when the particular programme section has run.

At the end of the programme all symbols have gone out and the progress bar is full.

Overdosage

The automatic safety system detects excessive froth in the appliance due to a highly frothing detergent or an overdosage. At the end of the programme this is indicated in the display field by the  symbol. Dispense less detergent for the next wash with similar items of washing (same degree of soiling and wash load).

Overdosage of detergent may cause excessive froth formation and impair the washing and rinsing results. A rinse cycle is automatically run.

 The  symbol goes out when the appliance switches off at the end of the programme or if the programme is changed.

Childproof lock

The activated childproof lock prevents the selected programme from being changed while the programme is running.

Recommended load

The recommended wash load is displayed depending on the selected programme and additional functions, see from page 21.

Spin speed

The maximum spin speed is displayed depending on the selected programme and additional functions. You can reduce this speed, see page 28.

Programme duration

When the programme has been selected, the expected programme duration (time after which the programme is expected to end) is displayed.

The programme duration is displayed in hours and minutes, e.g.

01:17 – 1 hour and 17 minutes

00:35 – 35 minutes.

When the programme has started, the colon : flashes between hours and minutes and the programme duration counts down in minutes.



When the programme ends, the displays shows **-0-**.

i While the programme is running, the programme duration may be extended or reduced for the following reasons.

Reductions in time occur because of:

- small loads,
- reduced heating times, e.g. if the water is very hot.

Increases in time occur because of:

- additional rinse cycle if excessive foam is in the laundry,
- multiple spinning if the laundry is distributed poorly in the drum,
- increased heating times, e.g. when the water is too cold,
- water pressure too low.
- selection of an additional option, e.g.  and/or  after the programme has started,
- very absorbent washing extends the heating duration.

Start time

You can delay the start time, see page 29.

Before using your washing machine for the first time

Preparing your washing machine

Attention

The washing machine must have been installed and connected properly (refer to Page 51).

- i** The washing machine was tested before leaving the factory. To remove any water left over from testing procedures, the first washing cycle should be carried out **without** laundry in the machine.
- Turn the tap on.
- Pull out the detergent drawer all the way.
- Pour approx. 1 litre / 1 ¾ pt of water into chamber **II** of the detergent dispenser.
- Half fill the measuring beaker with detergent and pour into chamber **II**.
- i** Do not use any special detergents for delicates or woollens (excessive foam).
- Close the detergent drawer.
- Close the washing machine door.
- Set the programme selector to **Cottons/Coloureds 90 °C**.
- Press the  button.
The programme starts.

The programme ends when all symbols in the upper row of the display field go out, the progress bar is completely filled and the programme duration is on **-0-**:

- Turn the programme selector to **Off**.

Preparing, sorting and loading the washing

Preparing the washing

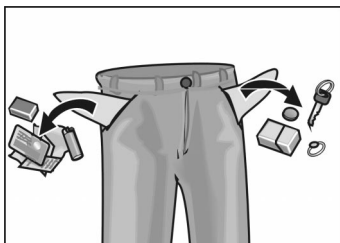

Attention

Loose debris (e.g. coins, paper clips, needles, nails) can damage items of clothing as well as parts of the washing machine (e.g. drum).

- Empty all pockets on items of clothing.
- Brush sand out of pockets and cuffs/turn-ups.
- Close zips, fasten pillow cases/cushion covers.
- Remove curtain runners or tie up in a net/bag.
- Wash in a net/cushion cover:
 - delicates, e.g. tights, curtains,
 - small laundry items, e.g. socks or handkerchiefs,
 - underwired bras (underwire may become detached during washing and cause damage).
- Trousers, knitwear and knitted textiles, e.g. jersey garments, T-shirts or sweatshirts should be turned inside out.

Sorting the washing

According to colour and degree of dirt

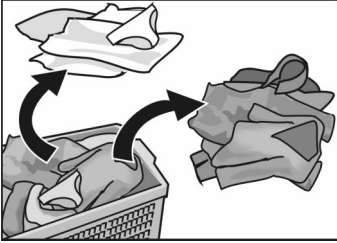

Attention

Washing may become discoloured. Do not wash new coloured washing with other washing.

White items may become grey. Wash white and coloured items separately.

Degrees of dirt

lightly soiled

No visible soiling or stains. Washing has probably absorbed body odour.

- Light-weight summer clothing and sportswear worn for several hours.
- T-shirts, shirts, blouses worn for up to one day.
- Bed linen, guest towels used for one day.

normally soiled

Visible soiling and/or a few light stains.

- T-shirts, shirts, blouses soaked in sweat or worn several times.
- Underpants, briefs worn for one day.
- Tea towels, hand towels, bed linen used for up to one week.
- Curtains (without nicotine soiling) used for up to six months.

very soiled

Visible soiling and/or stains.

- Kitchen towels used for up to one week.
- Fabric serviettes.
- Baby bibs.
- Children's outer clothing or football jerseys and shorts soiled with grass and/or earth.
- Work clothes, e.g. mechanic's overalls, baker's and butcher's clothing.

Typical stains

- Skin grease, cooking oil/fat, sauces, mineral oil, wax (containing fat/oil).
- Tea, coffee, red wine, fruit, vegetables (which can be bleached).
- Blood, egg, milk, starch (containing protein, carbohydrate).
- Soot, earth, sand (pigments), tennis clothing soiled with red clay.

Removing stains

Remove/pretreat stains as soon as possible after they have occurred.

First dab with a soapy solution. Do not rub.

Then select the appropriate programme and wash the item.

Stubborn/dried in stains can sometimes only be removed by washing several times.

Sorting washing according to the instructions on the care labels

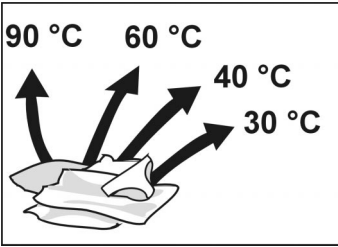

Only wash laundry that is labelled with the following care symbols:

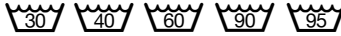

hard-wearing textiles, heat-resistant textiles
e.g. made from cotton or linen,



for easy-care textiles
e.g. cotton, linen, synthetic materials or blended fabrics



for easy-care, washable textiles
e.g. silk, satin, synthetic materials or blended fabrics
(e.g. curtains)



for hand and machine washable wool or wool-rich textiles
e.g. cashmere, mohair or angora,
also suited for hand washable silk

Do not wash laundry items which bear the following care label in the washing machine:



= do not wash

Loading the washing

⚠ Risk of explosion!

Items of clothing that have been pretreated with solvent-based cleaning agents, e.g. stain remover and dry cleaning spirit, represent an explosion hazard once loaded into the washing machine. Before loading the laundry, rinse thoroughly by hand.

Attention

Foreign objects in the drum may damage the laundry. Before loading the laundry, check that there is no debris in the drum.



- ❑ Open the washing machine door.

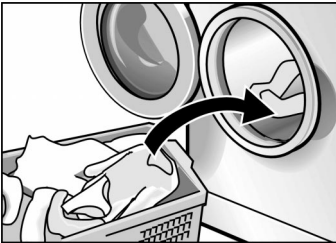

- ❑ Unfold the sorted items of clothing and place them loosely into the drum. Mix large and small items. Laundry items which vary in size are more evenly distributed during the spin cycle.

- ❑ **i** Do not exceed recommended loads. Overloading will cause poor wash results and encourage creasing.

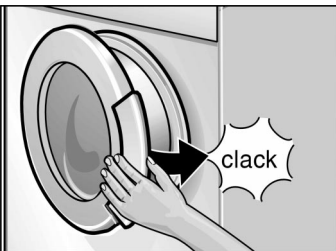

- ❑ Close the washing machine door. Take care not to trap any items of clothing between the loading door and rubber seal.

Detergents and cleaning products

Dosing detergent

⚠ Risk of poisoning!

Keep detergents and additives out of the reach of children.

Dose detergent according to

- the water hardness. You can find out the water hardness from your water utility company.
- the amount of laundry.
- the degree of soiling.
Information on soiling can be found on Page 15.
- the specifications of the detergent manufacturer.
The correct dosage reduces the impact on the environment and produces a good washing result.

Pour liquid detergent into the corresponding dispenser.

Too little detergent:

- The laundry is not washed clean and eventually becomes grey and hard.
- Greyish-brown dots (grease spots) may stain the laundry.
- The heating elements are calcifying.

Too much detergent:

- The environment is loaded.
- Excessive froth may be generated during the wash cycle causing a reduction in the washing mechanism. This may be the cause of poor washing and rinsing results.

Adding detergent/ cleaning product

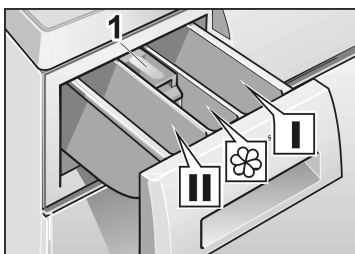

Dispenser I
Detergent for prewash or starch.

Dispenser II
Detergent for main wash, water softener, pre-soaking agent, bleach and stain removal product.

Dispenser ☼
Cleaning product, e.g. fabric softener or fabric conditioner (do not fill above the lower edge of the insert **1**).

- i** Concentrated or viscous fabric softener or fabric conditioner must be diluted with a little water before it is poured into the dispenser (prevents the overflow from becoming blocked).
- Pull out the detergent drawer all the way.
- Pour in detergent and/or cleaning product.
- Close the detergent drawer.

Programmes and functions

Programme selector

Select the desired programme - see also the separate programme overview.

In the **Cottons/Coloureds** programme the fabrics will be spun at the maximum possible spin speed.

In the **Easy-Care, Quick/Mixed, Delicates/Silk** and **Woolens** programmes the washing machine spins at a low speed – for gentle treatment of delicate laundry.

i Programmes wash lightly soiled textiles in the shortest possible time. For heavily soiled textiles reduce the load or press the  button!

Basic programmes

Cottons/Coloureds 30, 40, 60 °C

For hard-wearing textiles, e.g. made of cotton or linen.

Cottons/Coloureds 60 °C Stains

For stained, heavily soiled textiles, e.g. cotton or linen. Energy and water saving programme. The longer washing time in this 60 °C-programme means that the cleaning effects are comparable with those of a 90 °C-programme, although the power and water consumption is considerably lower.

Cottons/Coloureds 90 °C

Energy-intensive programme for heat-resistant textiles, e.g. made of cotton or linen.

To protect the waste-water pipes, the hot water is mixed with approx. 7 litres of cold water and cooled before being drained.

Easy-Care 30, 40, 60 °C

For easy-care textiles, e.g. made of cotton, linen, synthetic or blended fabrics.

i Also suitable as **short programme**.

Quick/Mixed 30 °C

Time-optimised programme for lightly soiled cotton textiles and easy-care textiles. Different types of washing can be washed together. Even suitable for washing new textiles before they are worn for the first time.

-  Wash white and coloured items separately. Do not wash new coloured washing with other washing.

Short washing time.

Delicates/Silk 30 °C

For delicate, washable textiles, e.g. silk, satin, synthetic materials or blended fabrics (e.g. curtains).

Delicates cycle at 30 °C for hand and machine washable silk.

-  We do not recommend washing these textiles with other rougher textiles.

No spin between the rinse cycles.

Wool 30 °C

For hand and machine washable wool or wool-rich textiles, e.g. cashmere, mohair or angora. Also suited for hand washable silk.

Programme options

Rinse

Rinse cycle with subsequent spin cycle for rinsing hand-washed items or for starching. Press the  button for an additional rinse cycle.

Reduced spin speed.

Spin

Spin cycle after a programme with setting "----" (without final spin) or for spinning hand-washed washing with selection of the required speed. Washing water or rinsing water is drained before the spin cycle.

Reduced spin speed.

Empty



Water is drained after a programme with the "----" (Without final spin) setting on display panel for gentle treatment of delicate laundry.

Additional option – buttons



The washing time is extended so that highly soiled washing or 6 kg of cottons/coloureds are washed more intensively.

Press the button in addition to the programme for the following combinations of load and degree of soiling:

Amount of laundry	Programme and button 	Degree of soiling
6 kg	Cottons/Coloureds 30, 40, 60 °C	lightly to normally soiled
	Cottons/Coloureds 60 °C	normally soiled with stains
	Cottons/Coloureds 90 °C	normally soiled
up to 5 kg	Cottons/Coloureds 30, 40, 60 °C	normally to heavily soiled
	Cottons/Coloureds 60 °C Stains	normally to heavily soiled with stains
up to 3 kg	Easy–Care 30, 40, 60 °C	normally to heavily soiled
	Quick/Mixed 30 °C	
up to 2 kg	Delicates/Silk 30 °C	
	 Wool 30 °C	

See the separate programme table for further information.



Additional rinsing of laundry.

Programme duration is extended accordingly.

Recommended application:
in areas with very soft water.



Gentler reduced spin cycle with subsequent fluffing.
After the spin cycle, the laundry is loose in the drum – creasing is reduced.



For very dirty, hard-wearing laundry, e.g. cotton or linen.

The washing temperature of the prewash is 30 °C.
Prewash cannot be selected for woollens programme.

i If the prewash is cancelled, the detergent solution is pumped out and the programme continues with the main wash cycle.

Washing with standard settings

The specified standard settings are optimally adjusted to the selected programme.

If you do not want to change these standard settings:

- Turn on water tap.



Example of **Easy-care 40 °C programme**:

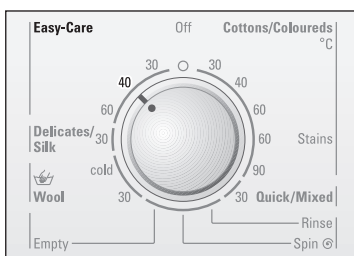

- Turn the programme selector to the desired programme – see also the separate programme overview

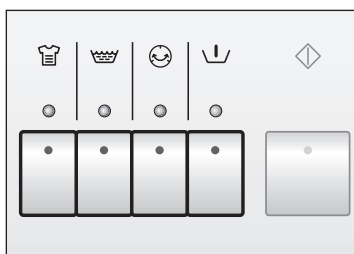

- If required, press the button(s) for additional option(s).
The indicator light of the selected button is on.

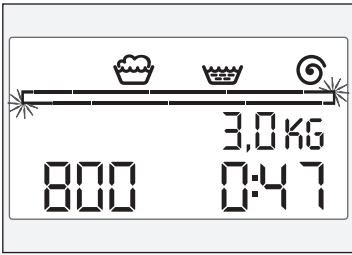

i The frame of the progress bar flashes in the display field and the following is displayed for the selected programme:

- the symbols for the programme sections,
- recommended load,
- maximum spin speed,
- programme duration.

Load the laundry and close the loading door. Do not exceed recommended loads.

Press the  button. The programme starts.

i The almost empty progress bar is indicated in the display field. The recommended wash load goes out. While the programme is running, the programme duration counts down and the progress bar fills up with the segments. The symbols for the run programme sections go out.

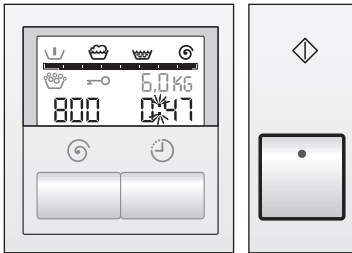

Washing with individual settings is described subsequently.

Washing with individual settings

You can adjust the settings to your requirements. First find a quick overview of the adjustable settings. The steps for changing the settings are described in detail overleaf.

Overview at a glance

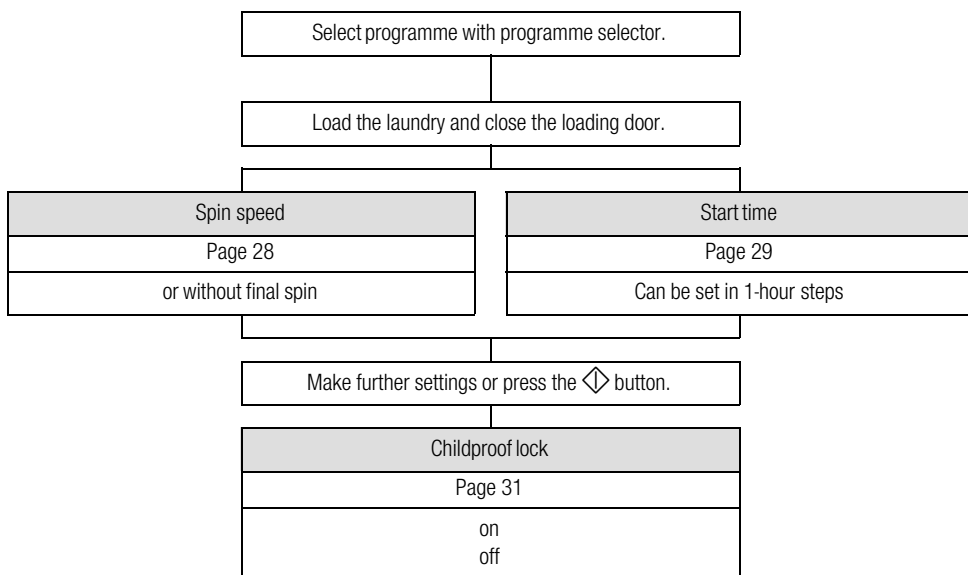

Spin speed

You can reduce the displayed spin speed.

The maximum displayed spin speed depends on the selected programme.

- Turn the programme selector to the desired programme.
- If required, press the button(s) for additional option(s).

Example of **Easy-care 40 °C programme**:

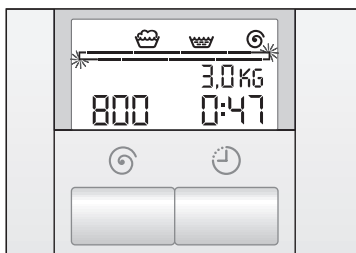

i The following is indicated in the display field:

- programme status display,
- recommended load,
- maximum spin speed, e.g. **800**,
- programme duration.

Load the laundry and close the loading door.

Press the  button until the required spin speed, e.g. **600** or "----" (without final spin) is displayed.

i If setting "----" (without final spin) has been selected, the washing remains in the final rinsing water. Before the laundry can be unloaded, the **Empty** or **Spin** programme must be performed.

You can change other settings
or

Press the  button.
The programme starts.

i The speed can be changed at any time by pressing the  button until the new speed is displayed.
Setting "----" (without final spin) is possible until the Rinse programme section starts.

Start time

Before a programme starts, you can specify by how many hours the start of the programme is to be delayed.

- Turn the programme selector to the desired programme.
- If required, press the button(s) for additional option(s).

Example of **Easy-care 40 °C programme**:

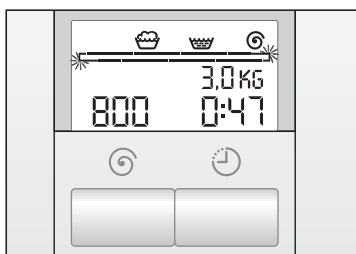

i The following is indicated in the display field:

- programme status display,
- recommended load,
- maximum spin speed,
- programme duration, **0:47** (47 minutes).

Load the laundry and close the loading door.

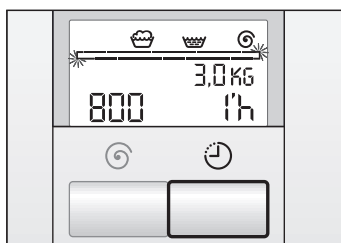

Press the  button, **1'h** (h=hour) appears in the display.

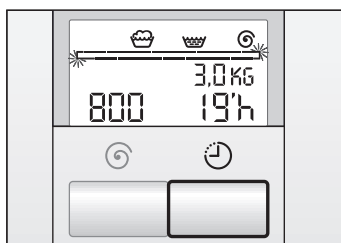

Press the  button until the desired number of hours is displayed.

i The start time can be set in 1-hour steps.
The time can be delayed up to a maximum of **19'h**.
If a start time of **19'h** has been set, the programme duration mode can be accessed by pressing the  button again.

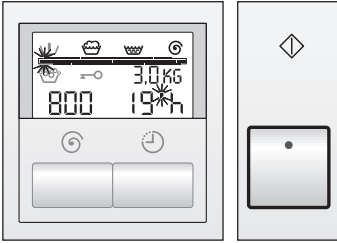

You can change other settings
or

- Press the  button.
The programme starts.

The time delay begins running immediately after the programme starts. This is displayed by the flashing first segment in the progress bar and the flashing apostrophe ' between the number and **h**.

- i** The time delay is counted down by the hour.
When the start time has elapsed, the programme starts automatically and the programme duration is displayed.
- i** Changes to the start time or an immediate start are possible. To do this:
 - Briefly set the programme selector to another programme.
 - When the programme selector has been reset to the original programme, individual or all other settings may have to be reselected. If required, reset the start time.
 - Press the  button.
The programme starts.
- i** If the programme sequence is changed by rotating the programme selector or the programme is cancelled, the preselected start time is also cancelled. The programme duration of the newly selected programme appears in the display. The start time must be reselected (see also chapter **Changing the programme**, page 32 and **Cancelling the programme**, page 33).
- i** The washing can be topped up at any time during the start time. Close the washing machine door.

Childproof lock

You can secure your washing machine to prevent selected functions from being inadvertently changed.

If the childproof lock has been selected:

- No changes can be made while the programme is running,
- the symbol \leftrightarrow flashes if a programme setting is inadvertently changed,
- should the appliance be switched off and on while a programme is running the programme will continue at the point at which it was interrupted,
- the washing can be topped up while the start time is running.

Activating the childproof lock

- Set the programme selector to the required programme and, if required, select other settings.
- Load the laundry and close the loading door.
- Press the \diamond button.
The programme starts.
- Release the \diamond button.

Example of **Easy-care 40 °C programme:**

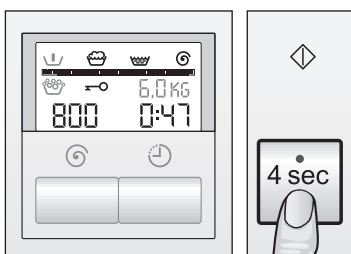

- Press the \diamond button and hold down (for approx. 4 seconds) until the \leftrightarrow symbol is displayed.
- Release the \diamond button, the childproof lock is activated, the symbol is permanently on.

Deactivate childproof lock

The childproof lock must be deactivated before making programme changes or ending programmes with setting "----" (without final spin).

- Press the \diamond button and hold down (for approx. 4 seconds) until the \leftrightarrow symbol goes out.
- If there is a power failure, the childproof lock remains on.

During washing

Changing the programme

If you have accidentally selected the wrong programme:

- If the childproof lock is active, temporarily deactivate; see Page 31.
- Turn the programme selector to a newly selected programme.
If Prewash is selected subsequently, set the programme selector to **Off** and reselect the programme.
- If required, change the other settings; see from Page 27.
- Press the  button.
The programme starts.
- i** The newly selected programme starts at the programme section at which the previous programme was cancelled, however with the new settings.
- If required, re-activate the childproof lock (see page 31).

Cancelling the programme

If you would like to terminate a programme and remove the washing:

- If the childproof lock is active, deactivate; see Page 31.
- Turn the programme selector to **Empty, Spin** or **Rinse**.
If required, select the desired spin speed (but not setting "----" (without final spin)).
- i** If a programme is interrupted at a high temperature, **Rinse** should be selected to cool down the washing.
- Press the  button.
- If required, switch on the childproof lock again.
- Wait until programme ends.
- If required, deactivate the childproof lock.
- Turn the programme selector to **Off**.
- Open the washing machine door.
- Remove the washing.
- i** If a programme was interrupted at a high temperature, the washing machine door may remain locked until the appliance has cooled down.

After washing

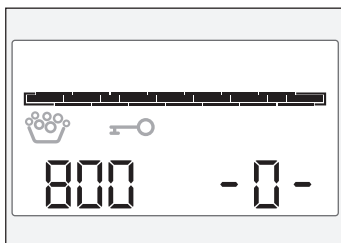

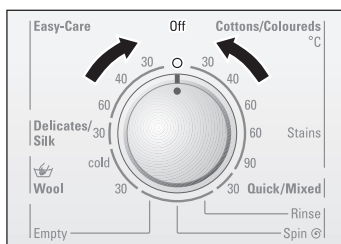

- i** Display panel:
 - all symbols on the programme status display have gone out, the full bar is displayed,
 - the programme duration is on **-0-**,
 - if the childproof lock is selected, the \rightarrow symbol illuminates,
 - if detergent was overdosed, the  symbol illuminates.
- If required, deactivate the childproof lock.
- Turn the programme selector to **Off**.

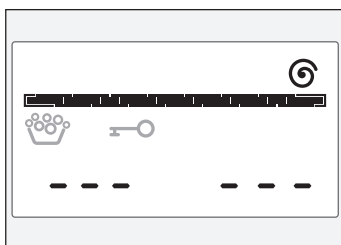

or

Setting "----" (without final spin) selected



- i** Display panel:
 - the  symbol and the full bar are indicated on the programme status display,
 - the programme duration is on "----".
 - if the childproof lock is selected, the \rightarrow symbol illuminates,
 - if detergent was overdosed, the  symbol illuminates.
- If required, deactivate the childproof lock.

- Select an additional programme **Empty** or **Spin**.
- Press the  button.
- If required, activating childproof lock.

At the end of the additional programme:

- If required, deactivating childproof lock.
- Turn the programme selector to **Off**.

Removing the washing

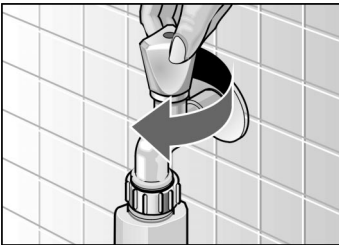

- Turn off the water tap.
- Open the washing machine door.

If the loading door cannot be opened:

Wait 2 minutes (safety function is active)

or

there is still water in the washing machine if the "----" (Without final spin) option was selected.

Select the **Empty** or **Spin** programme and press the  button.

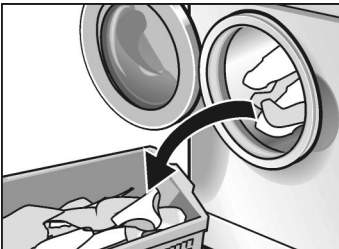

- Unload the laundry.

Attention

Remove any foreign objects (e.g. coins, paper clips) from the drum and rubber seal – **risk of rust!**

- Leave the washing machine door and detergent drawer open to allow the interior of the washing machine to dry.

Special applications

Soaking

- Load laundry of the same colour.
- Pour soaking agent into dispenser **II** according to the manufacturer's instructions.
- Set the programme selector to **Cottons/Coloureds 30 °C**.
- Press the  button.
The programme starts.
- After approx. 10 minutes, turn the programme selector to **Off**. The laundry is left to lie in the water.
- Select a programme according to the required soaking time, the detergent solution is pumped out.
- i** Only little detergent to be dispensed for the main wash.

Starching

The laundry must not be treated with fabric softener.

- Insert the washing.
- Dose a quantity of starch for approx. 15 litres of water. Dissolve starch according to the manufacturer's instructions.
- Turn the programme selector to **Rinse**.
- Set the spin speed; even setting "----" (without final spin) is possible.
- Press the  button.

As soon as the water runs in:

- Pull out the detergent drawer a little and
- Pour starch solution into dispenser **I**.
- Close the detergent drawer.

If setting "----" has been selected, select the **Empty** programme.

Dyeing

Only use dyes that are environmentally compatible and suitable for use in washing machines.

Attention

Washing in subsequent wash cycles may become discoloured.

- Apply dyes according to the manufacturer's instructions.

After dyeing:

- Pour approx. ½ measuring beaker of detergent into dispenser **II**.
- Without any laundry in the drum, allow the **Cottons/Coloureds 90 °C** programme to run through.
- Wipe out the rubber seal.

Bleaching

Attention

Bleaches may contain sulphur or chlorine which can corrode components of the washing machine. Do not bleach washing in the washing machine.

Cleaning and Care

⚠ Risk of electric shock!

First, always disconnect the appliance from the power supply.

Never clean the washing machine with a water jet.

⚠ Risk of explosion!

Never clean the appliance with solvents.

As required:

- Use hot soapy water or a mild, non-abrasive cleaning agent.
- Wipe dry with a soft cloth.

Clean housing, fascia and supply lines

Cleaning the drum

If metal items (e.g. coins, paper clips, needles, nails) left in the drum have caused rust spots:

- Use chlorine-free cleaning agents; comply with the manufacturer's instructions. Never use steel wool.

Cleaning the detergent dispenser

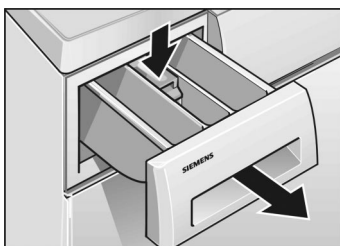

In the event that residual detergents or additives have accumulated:

- Pull out the detergent drawer all the way,
- Press down the insert and
- remove the detergent drawer.

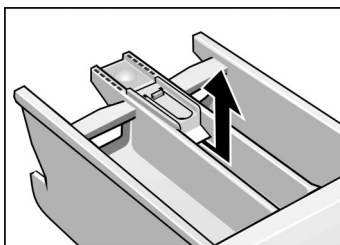

- Lift out the insert.
- Clean the detergent drawer and insert under running water and dry.

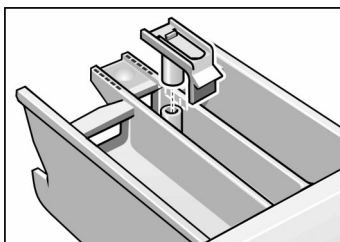

- Attach the insert and lock into position.
- Slide in the detergent drawer.

Cleaning the drain pump

Drain the water

This is necessary if the washing solution has not been completely drained. The pump is blocked by either loose debris or fluff which accumulates if fluff-giving fabrics are washed.

(Up to 20 litres. Have a suitable container ready.)

⚠ Risk of scalding!

Allow the hot water to cool down beforehand. Keep children and pets away from the washing machine.

Turn the programme selector to **Off**.

Open service flap.

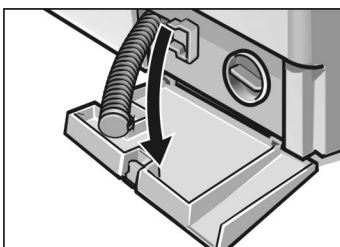
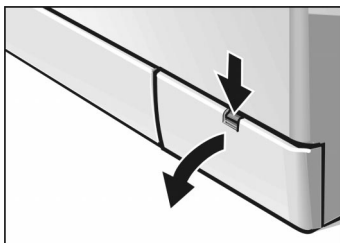

Remove the drain hose from its holder and pull the hose out of the housing.

Remove the service flap.



Pull down the closing cap and allow the washing lye to flow into a suitable container.

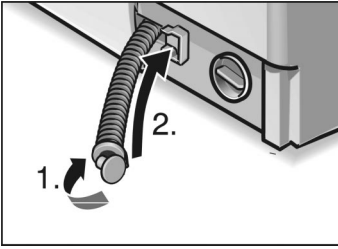

- ❑ Push up the closing cap (**1st**) and place the drain hose back in its holder (**2nd**).

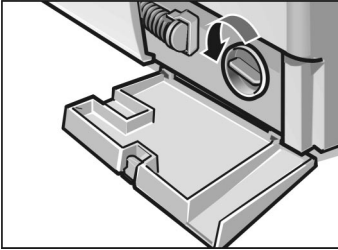

- ❑ Carefully remove the pump cap.
A little more residual water will flow out.
- ❑ Remove foreign objects/fluff from inside and clean the interior. The pump impeller wheel must be able to rotate.
Clean any residual lye or fluff from the thread of the pump cap and pump housing.

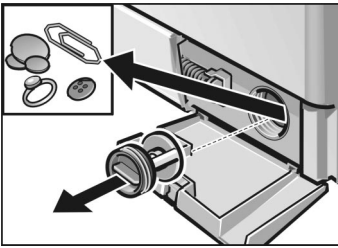

- ❑ Insert the pump cover and screw tight.
- ❑ Insert and close the service flap.

To prevent unused detergent from flowing into the drain during the next wash cycle:

- ❑ Pour 1 litre / 1 $\frac{3}{4}$ pt of water into chamber **II**.
- ❑ Select the **Empty** programme.

Cleaning water inlet strainers

This is necessary if very little or no water flows into the washing machine.

First, reduce the water pressure in the inlet hose:

- Turn off the tap.
- Turn the programme selector to any programme (except **Spin / Empty**).
- Press the  button, and allow the programme to run for approx. 40 seconds.
- Turn the programme selector to **Off**.

Cleaning the strainer at the water tap

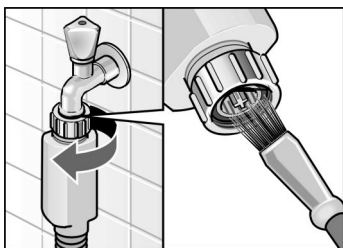

- Disconnect the hose from the water tap.
- Clean the filter with a small brush or paint brush.
- Connect the hose.

Cleaning the strainer on the washing machine



- Disconnect the hose from the back of the washing machine.

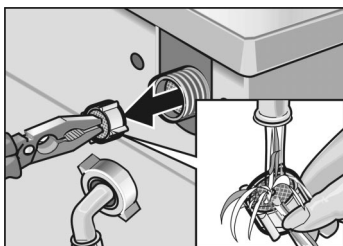

- Pull out the strainer and rinse under running water.
- Insert the strainer and reconnect the hose.
- Turn on the water tap and check whether water is still discharged. If water is still discharged, check that the strainer is attached properly.
- Turn off the water tap.

Descaling the washing machine

Attention

Descaling agents contain acids which may corrode the components of the washing machine and discolour the washing.

Provided that you use the correct amount of detergent, it is not necessary to descale the washing machine.

If descaling is nevertheless required, please follow the instructions supplied by the manufacturer of the descaling agent.

Help with minor problems

If repairs are needed, and assuming that you cannot eliminate the fault yourself with the aid of the following table:

- Turn the programme selector to **Off**.
- Disconnect the washing machine from the mains.
- Turn off the tap.
- Call customer service, see Page 50.



⚠ Risk of electric shock!



Repairs may be carried out by customer service or authorised technicians only.



Fault displays

Text in display field and, depending on the model, a signal emitted	Possible cause	Remedial action
F01	Door not closed properly.	Check whether laundry is trapped in door; Close the washing machine door.
F02	Tap not turned on.	Turn the tap on.
	Inlet hose kinked or pinched.	Eliminate cause.
	Filters blocked in water inlet hose.	Clean filters, see Page 42.
	Water pressure too low.	Eliminate cause.
F04	Loose debris is blocking the pump;	Clean the pump, see Page 40;
	Drainage pipe and/or drainage hose blocked.	Clean drainage pipe and/or drainage hose.

Problems	Cause	Remedial action
Washing machine door cannot be opened.	There is still some water in the appliance, "----" (without final spin) selected.	Select Empty or Spin .
	Safety function is active.	Wait for 2 minutes.
Detergent residue in the detergent drawer.	Damp or lumpy detergent.	Clean and dry the detergent dispenser; see Page 39.
	Difficult-to-dissolve detergent tablets used.	Use the dosing aid for liquid detergent. Before filling dispenser II, crush the tablets in the packet.
Odour in the appliance.	Washing at mainly low temperatures and/or with liquid detergents.	Run the Cottons/Coloureds 90 °C programme without washing. Use a standard detergent.
Control lights do not come on.	A fuse has tripped.	Switch on/replace the fuse. If the fault occurs repeatedly, call Customer Service.
	Power failure.	An interrupted programme will be resumed when the power returns. If you wish to unload the laundry, proceed as in Cleaning the drain pump , page 40.
	Plug is loose or not plugged in.	
Programme does not start.	Loading door not closed properly.	Check whether laundry is trapped in door. Close the loading door (a click should be heard).
	◊ button not pressed.	Press the ◊ button.
Water does enter the machine or detergent is not washed away.	Tap not turned on.	Turn the tap on.
	Inlet hose kinked or pinched.	
	Filters blocked in water inlet hose.	Clean the strainers; see from Page 42.
Detergent in chamber I is not washed away.	A programme without Prewash was selected.	Select programme with Prewash.







Problems	Cause	Remedial action
Water not visible in the drum.	Not a fault. The water lies below the visible part of the drum.	
Washing solution is not completely drained.	Pumped blocked by foreign objects. Fluff-producing laundry was washed. The water drainage pipe or drain hose is blocked.	Clean the pump (refer to page 40). Clean drainage pipe and/or drainage hose.
Water runs out from under the appliance.	Screw fitting of the inlet hose is leaking. Drainage hose is leaking.	Tighten the screw-fitting. Replace the drain hose.
Foam comes out of the detergent drawer. The  symbol is displayed at the end of the programme.	Too much detergent or detergent not suitable for use in washing machines used.	Mix 1 tablespoon of fabric softener with ½ litre / 1 pt of water and pour into chamber II of the detergent dispenser. Reduce detergent dosage for next wash cycle or use detergent which is suitable for use in washing machines.
The washing has not been spun correctly.	Large laundry items have become entangled and are not evenly distributed in the drum. For safety reasons, the high-speed final spin cycle was automatically cancelled.	Do not put only large items in the drum.
Spin result unsatisfactory.	 button pressed – for reduced spin speed see page 23. The Rinse or Spin programme selected maximum spin speed: see Page 22.	
Spin cycle actuated several times.	Not a fault. Unbalanced load detection system is attempting to compensate the imbalance by spinning the washing several times.	
The programme takes longer than usual.	Not a fault. Imbalance compensation system attempts to balance the laundry by repeated distribution. The foam detection feature has activated an additional rinsing cycle to reduce the amount of foam.	Wash large and small items together in order to reduce the imbalance. Adjust the detergent dosage for the next wash cycle.

Problems	Cause	Remedial action
Washing result not satisfactory.	Soiling is greater than expected or recommended load has been exceeded.	Select suitable programme and press the  button or reduce load.
	Detergent was underdosed.	Dose detergent according to the manufacturer's instructions.
Detergent residue on the washing.	Some phosphate-free detergents contain water-insoluble residue which may appear as light stains on the washing.	Select Rinse immediately or brush out the washing after drying.
Grey residue on the washing.	Soiling caused by ointment, grease or oil.	Select maximum detergent dosage and maximum permitted temperature for the next wash cycle.
Programme duration changed during the programme sequence	Not a fault. See also explanations in the chapter Display field, programme duration from page 12.	
Programme duration reduced	Not a fault. For small amounts of laundry, a reduction in time of approx. 30 minutes can result, depending on washing programme.	
Programme duration extended	An overdosage of detergent has caused excessive formation of froth. An additional rinse cycle and spin cycle was run to ensure a good rinsing result. The  symbol is displayed at the end of the programme.	Reduce the detergent dosage for the next wash cycle.
	For severe imbalances during spinning, an increase in time of approx. 10 minutes can occur because of repeated distribution of the laundry.	Wash large and small items together in order to reduce the imbalance.
	If very cold water must be heated up, an increase in time up to 20 minutes can result.	

Problems	Cause	Remedial action
Signal is emitted	Signal for switching buttons on and off is switched on.	Switch off the signal: Press the  button and set the programme selector to Cottons/Coloureds 30 °C . Hold down the  button until the signal is emitted. Acoustic signal is switched off.
	Signal for programme status is switched on.	Switch off signal or change volume: Press the  button and hold down until the signal is emitted and the volume of the signal changes. Release the button when the required volume is reached. The selected setting is stored.

If the fault recurs, call Customer Service, see Page 50.

Consumption values

Normal programme	Additional option	Load	Consumption values **		
			Power	Water	Programme duration
Cottons/Coloureds 40 °C	 *	6 kg	0.65 kWh	60 l	2:10 h
Cottons/Coloureds 60 °C	–	5 kg	0.95 kWh	60 l	1:17 h
Cottons/Coloureds 60 °C	 *	6 kg	1.02 kWh	46 l	2:10 h
Cottons/Coloureds 90 °C (the hot washing solution is mixed with approx. 7 litres of cold water before being drained)		6 kg	2.1 kWh	67 l	2:10 h
Easy–Care 40 °C	 *	3 kg	0.5 kWh	50 l	1:18 h
Easy–Care 40 °C (Also suitable as short programme)	–	3 kg	0.5 kWh	38 l	0:47 h
Delicates/Silk 30 °C	–	2 kg	0.3 kWh	42 l	0:35 h
 Wool 30 °C	 *	2 kg	0.2 kWh	35 l	0:50 h

* Programme setting with  option for test in accordance or in conformity with EN 60 456 and IEC 60 456.

** Consumption values will differ from the indicated values depending on the water pressure, water hardness, water inlet temperature, ambient temperature, type and quantity of washing and degree of soiling, utilised detergent, fluctuations in the mains voltage and selected additional options.

Customer service

Before you call customer service, please check whether you can eliminate the fault yourself (see from Page 44).

A technician who is called out to give advice will charge you, even if the appliance is still under guarantee.

You can find your nearest customer service in the enclosed address list. Please provide customer service with the product number (E-Nr.) and the production number (FD) of the appliance.

These numbers are shown on the rating plate which can be found on the frame of the open door and also on the identification plate, enclosed by a thick line, on the front of the machine behind the nameplate.

Rating plate

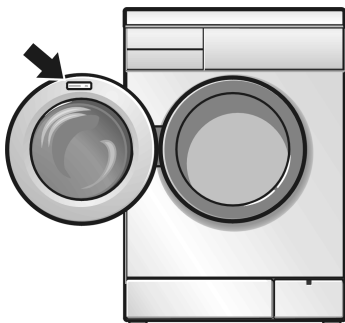

E-Nr. _____	FD _____
-------------	----------

Product number

Production number

Please note the two numbers in the space provided above.

In specifying the product number and production number of your appliance, you help us in our attempt to prevent unnecessary travelling and the associated extra costs.

Installing, connecting and transporting the appliance

Safety instructions

⚠ Risk of injury!

The washing machine is very heavy. Take care when lifting it.

Attention

Frozen hoses may tear/burst. Do not install the washing machine in an area where there is a risk of frost or outdoors.

The washing machine may be damaged. Do not lift the washing machine by its projecting parts (e.g. door).

In addition to the safety information listed here, the local water and electricity supplier may have special requirements.

If in doubt, have the appliance connected by a specialist.

Standard accessories

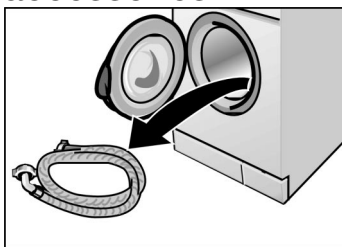

Inside the drum:

- Water-inlet hose.

Any dampness inside the drum is left over from final testing which every washing machine is subjected to before leaving the factory.

On the rear of the appliance:

- Water drainage hose.
- Elbow for attaching the drainage hose e.g. to the sink,
- Mains cable with plug.

Moisture in the drum is due to the final inspection which every washing machine undergoes before it leaves the factory.

Depending on the connection situation, the following part is also required:

- 1 hose clip Ø 24–40 mm (DIY store) is also required for connection to a siphon.

The bag contains:

- Spanner.
- Covers for holes left by removing the transport bolts.

The following tools are helpful:

- Box wrench A/F 13 for removing the transportation bolts,
- Spirit level for aligning the washing machine.

Useful tools

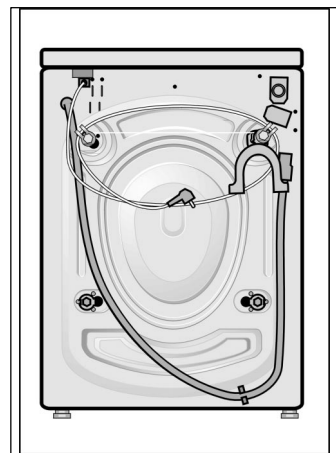

Dimensions

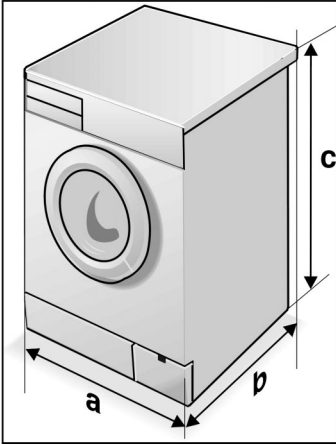

a = 600 mm

b = 590 mm

c = 852 mm

Weight 69–83 kg (depending on appliance)

Installation surface

Appliance stability is important so that the washing machine does not "wander" during the spin cycles.

The installation surface must be solid and level. Soft floor coverings, e.g. carpets or floor coverings with a foam backing are not suitable.

If the washing machine is to be installed on a wooden floor:

- If possible, install the washing machine in a corner.
- Screw a water-resistant wooden board (at least 30 mm thick) to the floor.
- Secure the washing machine feet with fixing brackets*.

If the washing machine is to be installed on a base:

- Secure the washing machine feet with fixing brackets*.

* Holding brackets (set) can be obtained from a specialist store or the Customer Service, order no. WX 9756.

Removing the transport bolts

Caution

The transport bolts must always be removed before using the appliance for the first time and must be retained for any subsequent transport (e.g. when moving).

Before removing the transport bolts:

- Take the hose out of the holder.
- Detach the elbow.
- Release all four transport bolts using the SW 13 wrench until they can be moved freely.
- Completely remove transport bolts by reaching through the open washing machine door and pulling the drum forwards slightly.

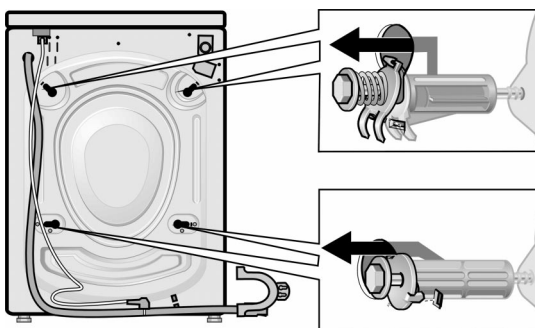

- Insert the covers.

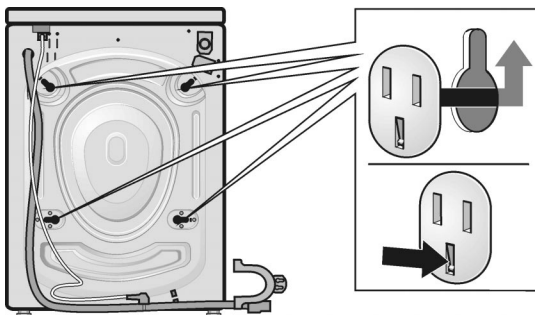

Storing the transport bolts

Always keep the transport bolts for subsequent transportation of the appliance (e.g. when moving house).

- Store the transport bolts with washer and bush (and spring) attached.

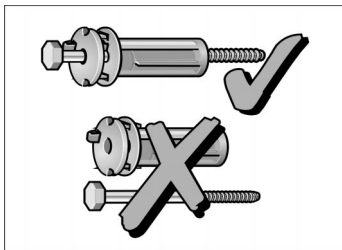

Hose and cable lengths

Connection on left side

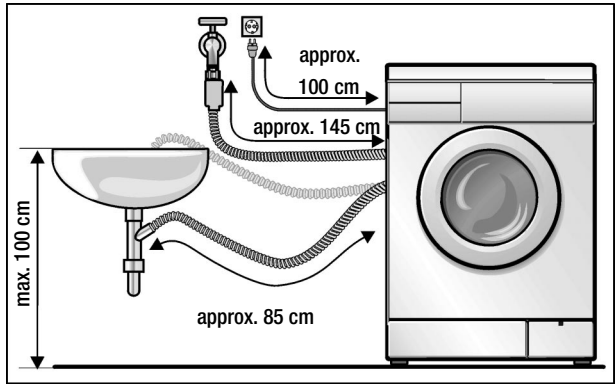

Connection on right side

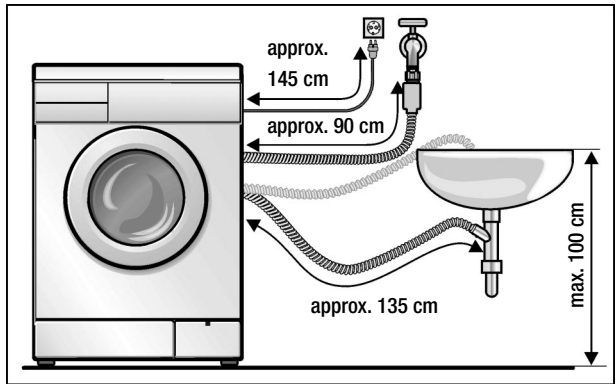

Other hoses

Available in kit form from specialist outlets:

- Connecting kit with plastic hose (approx. 2.50 m), order no. WZ 10130.

Connecting the water

Water inlet hose

To prevent leaks or water damage, it is essential to follow the instructions in this chapter!

Attention

Operate the washing machine with cold drinking water only. Do not connect to the mixer tap of an unpressurised hot-water apparatus.

If in doubt, have the appliance connected by a specialist.

The water inlet hose must not be

- kinked or crushed,
- modified or severed (strength is no longer guaranteed).

Check the mains water pressure:

- The water pressure should be between 1 and 10 bars (when the tap is turned on, at least 8 litres of water is discharged per minute).
- If the water pressure is higher, install a pressure reducing valve.

Connect the water supply hose.

- to the rear panel of the washing machine and ...

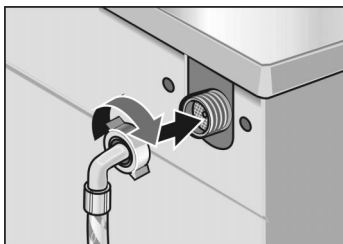

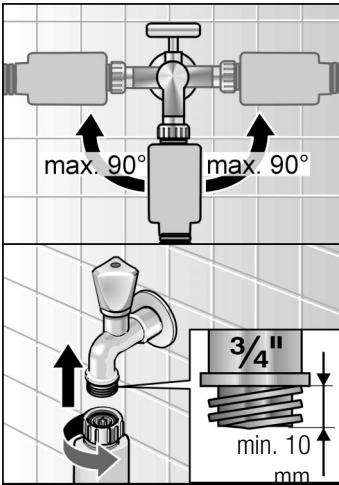

- to the tap.

After connecting the water inlet hose:

- Turn on the tap fully.
- Check the connection points for leaks.

Attention

Do not bend or pull the water drainage hose.

Height difference between the placement area and drainage point: maximum 100 cm.

Drainage into a siphon:

- Secure connection point with 24–40 mm Ø hose clip (specialist outlet).

Water drainage hose

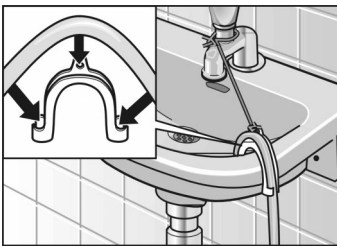
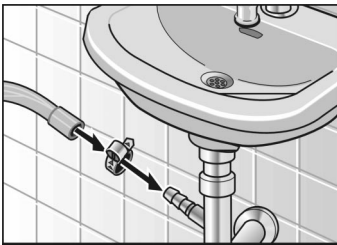

Drainage into a wash basin:

Attention

The plug must not block the drain of the wash basin.

- Secure the drainage hose to prevent it from slipping out of the sink.
- When the water is being pumped out of the washing machine, check that the water drains away quickly enough.

Aligning the washing machine

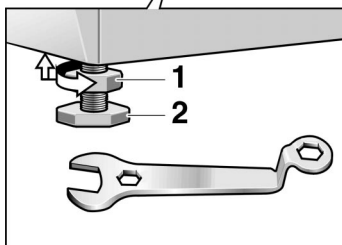
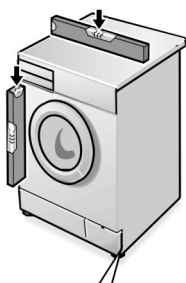

Level the washing machine with the assistance of the four adjustable feet and a spirit level:

- Loosen the lock nut **1** using the wrench.
- Adjust the height by rotating the foot **2**.
- Tighten the lock nut **1** against the housing. Simultaneously hold the foot in place and do not adjust the height.

All four feet must be firmly on the floor. The washing machine must not wobble.

The lock nuts of all four appliance feet must be screwed tightly against the housing!

Attention

Loud noise generation, vibrations and "wandering" may be due to incorrect alignment!

Connecting the power

Attention

Connect the washing machine only to an alternating current via a correctly installed earthed socket.

The mains voltage must correspond to the voltage specification on the washing machine (nameplate). Connection specifications as well as the required fuses are stipulated on the appliance nameplate.

Ensure that:

- The mains plug and socket are compatible.
- The cable cross-section is adequate.
- The earthing system has been installed correctly.

The mains cable may be changed (if required) by an electrician only.

Replacement mains cable available from customer service.

Do not use multiple plugs/sockets or extension cables.

In the event that an earth-leakage circuit breaker is to be used, only use types marked with the following symbol: .

Only this symbol can guarantee compliance with all current regulations.

Do not insert/pull out the mains plug with wet hands.

Do not pull out the mains plug by tugging the cable.

Transport, e.g. when moving

Before transporting the washing machine:

- Turn off the water tap.
- Drain any residual washing solution (refer to Page 40).
- Release the water pressure in the supply hose (refer to Page 42).
- Disconnect the washing machine from the mains.
- Dismantle the supply and drainage hoses.
- Reinstall the transport bolts.

Having transported the appliance and ensured proper installation and connection, allow the **Drain** programme to run through before starting the first wash programme.

Preparing and inserting the transport bolts

- Remove the covers.
- Preparing the transport bolts:
Pull the bolt out of the sleeve until the end of the bolt is flush with the end of the sleeve.
- Insert and tighten the transport bolts.
The lug on the washer must be located in the groove in the rear panel of the housing.

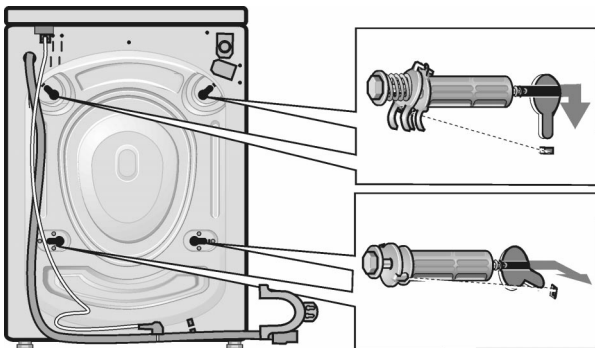

Index

A

- Activating the childproof lock, 31
- Additional options – buttons, 9, 23
- Aligning the washing machine, 59

B

- Basic programmes, 21
- Bleaching, 37

C

- Cancelling active programme, 33
- Care labels, 17
- Changing the programme sequence, 32
- Childproof lock, 10, 11, 31
- Cleaning and care, 38
 - Control panel, 38
 - Detergent drawer, 39
 - Drain pump, 40
 - Drum, 38
 - Housing, 38
 - Strainers, 42
 - Supply lines, 38
- Closing cap, 40
- Connecting the power, 60
- Connecting the water, 57
- Consumption values, 49
- Control panel, 9
- Cottons/Coloureds, 21–23
 - Stains, 21
- Customer service, 50

D

- Deactivate childproof lock, 31
- Degrees of dirt, 15
- Delicates/Silk, 22
- Descaling, 43
- Dimensions, 53
- Display panel, 9, 10
 - Childproof lock, 10
 - Fault display, 10
 - Overdosage, 10
 - Programme duration, 10, 12
 - Programme status display, 10, 11
 - Progress bar, 10
 - Recommended load, 10
 - Spin speed, 10
 - Start time, 10
- Disposal, information, 5
- Dosing detergent, 19
- Dyeing, 37

E

- Easy-Care, 21
- Empty, 22
- End of the programme, 34

F

- Fault display, 10, 44
- Functions, 21

H

- Hints and tips, 6
- Holding bracket, 53
- Hose and-cable lengths, 56

I

- Insert transportation protection devices, 61
- Installation surface, 53
- Internet, 4

L

- Loading the detergent, 20
- Loading the washing, 14, 18

O

- Old appliance, 5
- Overdosage, 10, 11

P

- Packaging, 5
- Preparing the washing, 14
- Prewash, 10
- Problems, 44
- Product number, 50
- Production number, 50
- Programme duration, 10
- Programme duration., 49
- Programme options, 22
- Programme selector, 9, 21
- Programmes, 21
- Progress bar, 10
- Protection of the environment, 6
- Pump cap, 41

Q

- Quick/Mixed, 22

R

- Rating plate, 50
- Recommended load, 10, 11
- Removing stains, 16
- Removing the washing, 35
- Rinse, 22

S

- Safety instructions, 7, 51
- Service flap, 40
- Soaking, 36
- Sorting the washing, 15
- Spin, 22
- Spin speed, 10, 11, 28
- Standard accessories, 52
- Starching, 36
- Start button, 9
- Start programme, 25
- Start time, 10, 12, 29
- Storing the transportation protection devices, 55

T

- Take out the drain hose., 40
- Tools, 52
- Transporting the washing machine, 61

W

- Washing, 25
- Washing machine, 8
- Wool, 22

