

SIEMENS



Becoming a statement.

The new coolModul series for an impressive home. Intelligent appliances with timelasting design.
siemens-home.bsh-group.com.hk

The future moving in.

German
Technology



Siemens Home Appliances

Distinguishing home with Siemens' breathtaking design and technology.

For those who want to set themselves apart.

Siemens coolModul series constantly challenges the status quo to create new, fascinating combinations of technology and design.

We all place great demands on ourselves. We strive to be the best in every aspect of our lives. And just as we expect the best from ourselves, we expect it from the things that surround us. This aspiration can now be fulfilled when it comes to the kitchen. The new range of coolModul cooling appliances and its modular concept opens up new possibilities. Create your individual cooling zones and express yourself with endless products arrangements.

The coolModul range includes fridges, freezers and wine cabinets as well as a French-Door fridge freezer in one unit. coolModul accessories are sold separately, please speak to your preferred kitchen specialist for installation options and more information.



Models shown: CI36TP02 French door refrigerator with impressive wine storage space (two wine cabinets: CI24WP03)



Grand opening day. Every day.

A new perspective on your food: Packed with innovative features, the all-new coolModul premium built-in fridge freezers open up to give you the best view of what is inside.

The large built-in French Door Bottom Mount has ample storage space and ensure your kitchen gets the statement it deserves. With hyperFresh plus and freshSense technologies, you will experience a truly fresh way of food storage. The storage layout provides clear-cut food separation, exact humidity levels and a more stable temperature management for prolonged food freshness.

French door refrigerator:

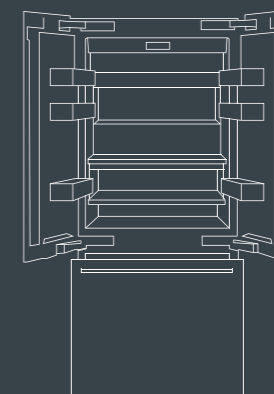

■ 91.4cm width

Living, the large way.

Quench your taste for more. Column by column. With these premium single door fridge and freezer.

Each of these appliances can easily become a part of side-by-side arrangement. Both deliver big when it comes to creating the cooling space you desire. Thanks to the range's great flexibility – simply decide whether fridge on the left, the freezer on the right? Or the other way round? Or rather a grand opening in the middle? An elegant wine cabinet can side the fridge or the freezer – coolModul makes sure you get it.

Single door fridge and freezer:



61cm width

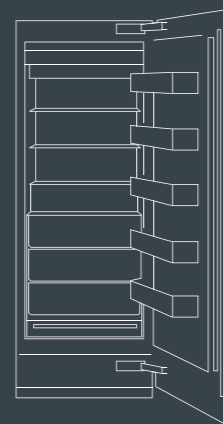

61cm width





Beautifully displayed. Immaculately stored.

Truly understanding the culture of wine, means you respect its peculiarities. The premium built-in wine cabinets were designed specifically to create optimal conditions.

There is no need for an elaborate wine cellar if you can store your precious goods in perfect conditions in your kitchen. Our intelligently designed wine cabinet make wine cellars redundant. Now you can store your favorite liquid treasures in absolutely immaculate conditions. With up to three different cooling zones, each zone comes with independent humidity control, delivering immaculate precision with regards to storage

Wine cabinet available in two sizes:

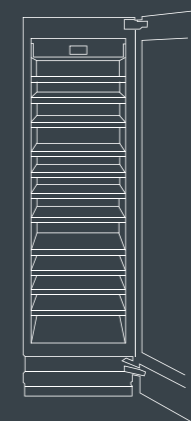

- 45.7cm width
- 61cm width

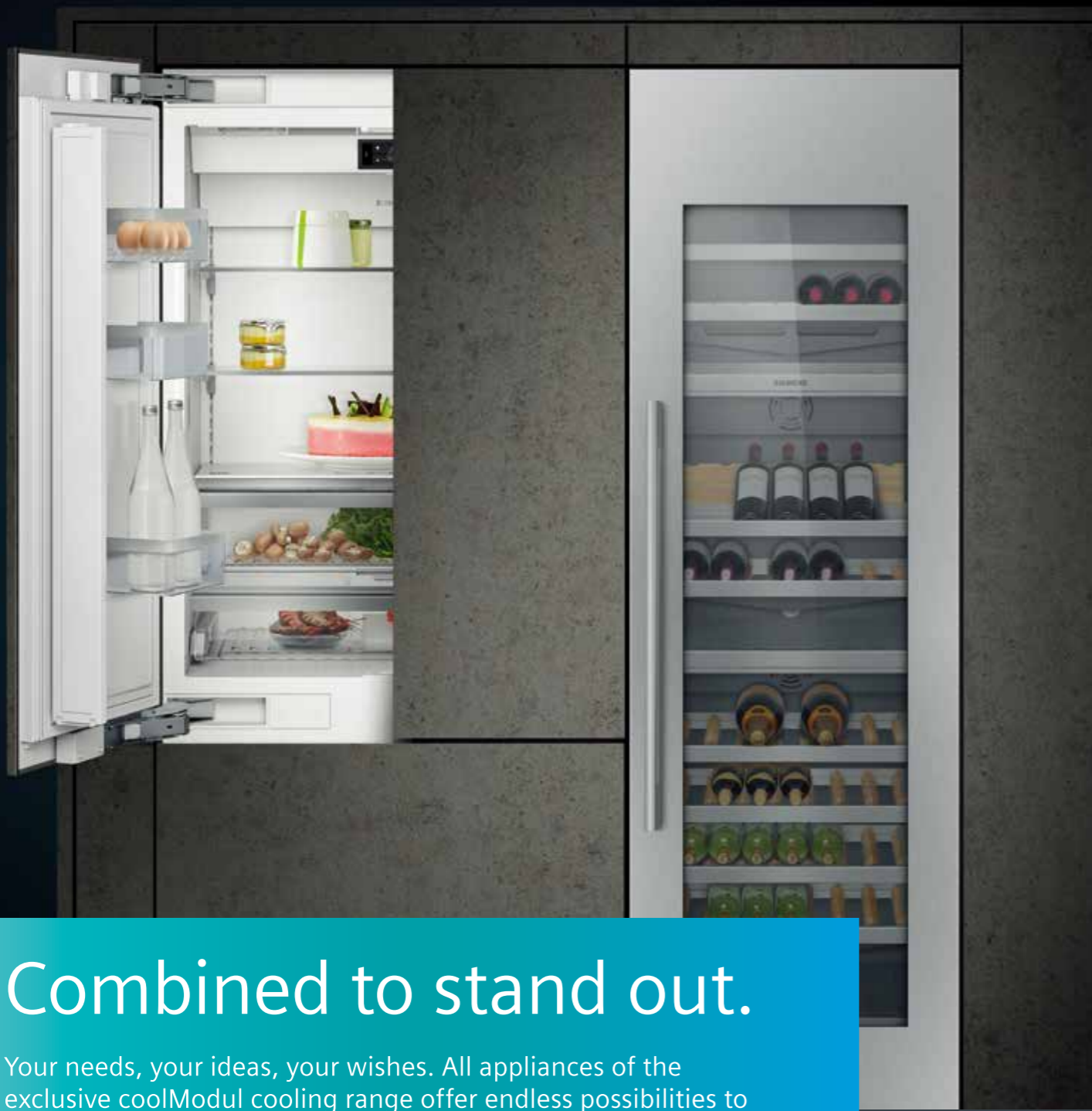

Combined to stand out.

Your needs, your ideas, your wishes. All appliances of the exclusive coolModul cooling range offer endless possibilities to meet highest demands. They are modules that allow you to make a personal statement and possess the power to impress.

The closer to perfection you get, the more you'll find it in the details. That's why every single one of our products follows the principle of the ideal fit.

We understand that you do not want anything to restrict your idea of an immaculate solution for your cooling zone. And that's precisely the reason we designed the coolModul series – to be combined with any restrictions, but as individually as you want them to be.



Ready for anything, optimal space arrangement
 Combine the French door refrigerator with the elegant wine cooling unit to create one all-round cooling zone.
 - CI36TP02 French door refrigerator (91.4cm)
 - CI18WP03 wine cabinet (45.7cm)



Three columns of freedom, luxury with all the conveniences
 Choose three or more different columns that allow you to store large amounts of fresh and frozen goods and a carefully chosen selection of exquisite wines.
 - FI24NP32 1-door freezer (61cm)
 - CI24RP02 1-door fridge (61cm)
 - CI24WP03 wine cabinet (61cm)



A possible connoisseur's choice, with a taste for more
 The French door refrigerator is accompanied by one or two wine cabinets, displaying your distinguished taste in an impressive manner. For the wine cellar feeling, without the cellar.
 - CI36TP02 French door refrigerator (91.4cm)
 - CI24WP03 wine cabinet (61cm) or a pair





Designed to make an impact.

Design is as much about intuition as it is about quality. Amidst impressive statement designs, the coolModul range delivers multiple highlights.

Exquisite design is an essential part of the coolModul heritage. The new line of cooling appliances is further remarkable proof of this, both from the inside and the outside. Take, for example, the high-end materials and surfaces that you can't help but reach out and touch, from a splendid blend of metal and wood components to the enchanting light of the dazzling illuminations.



Smart living with your smart appliance

The coolModul range equip with Home Connect, you can control your appliances using your smart devices, such as smart phone or tablet anytime and anywhere.

You are buying frozen foods for the weekend party at supermarket, just activate superFreezing with your mobile to cool down your freezer for the new items. You are choosing a champagne to share with your loved one, just cool down your wine cabinet temperature from your mobile to get wine cabinet prepared for chilling the champagne tonight. The fridge door has accidentally been left open? You will get a push notifications to alert you.

Download and install  Home Connect



Apple, the Apple logo are trademarks of Apple Inc., registered in the U.S. and other countries. App Store is a service mark of Apple Inc.



Google Play is a service provided by Google LLC



Fronts that express your style.

Make a statement that lasts: Choose the fronts that fit your style, your vision of a kitchen. You decide whether your individual cooling space will be smoothly integrated with your cabinets behind warm wooden fronts. Or if you'd rather go for the elegant high-end stainless steel fronts that leave an instant impression – making you want to open the door to explore the inside.

Handles that fit your personality.

If you have chosen the cool and modern appearance of metal fronts, you will need to go for a set of high-grade handles, too. If you have picked the wooden fronts for your kitchen, you may wish to select our high-quality handles that can be attached to the outside, fostering a unified look in the room. In case you have already decided for different handles for your kitchen, you may as well attach them to all appliances, gaining a unify look through the whole room. Or perhaps you prefer the beauty of the integrated handles, which allow plain integration with your kitchen cabinets – with no details giving away the impressive cooling space behind the door.



Sophisticated storage, Stunning functions

With a digital display that shows the precise temperature and helps navigate easily through the operating menus, a door sensor that sets off a warning alarm if the door is left open for any reason. The eco mode helps you to save energy, whilst the holiday setting keeps your items cooled or frozen while you are away for longer periods. coolModul series from Siemens features top of the range technologies.

Discover quality of high standards

Exclusive to CI36TP02 French door refrigerator, fridge and freezer compartments are powered by separate cooling circuits with individual temperature controls using 2 evaporators. The 2 Cooling System ensures constant even temperatures and ideal humidity. The cold air is hence not shared between the freezer and the fridge.

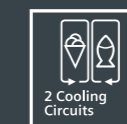

An intelligent freshness technology: freshSense

Fresh food helps to promote good health. The freshSense technology ensures long-lasting freshness in fridges and freezers. A combination of temperature sensors with smart electronics constantly cross-check the outsides and inside temperatures. They create a controlled environment and optimum temperature, keeping the refrigeration of the food steady. As a result, foods stay fresh and aromatic longer.





Good cooking begins with freshest ingredient

Your fresh food can now last twice as long as it would than in a standard vegetable drawer with the Siemens hyperFresh plus drawer. With an innovative humidity control feature, the drawer retains minerals and nutrients from your vegetables, salads and fruits, increasing their durability longer.



Fully extendable drawers on telescopic rails

The drawers in the fridge and freezer section can be easily pulled out completely and gives a better overview of the refrigerated food. This is ideal because nothing can fall out while getting food items stored at the back of the refrigerator even when stacked fully.



Heavy duty fixed hinge

A fixed hinge means that the furniture door is mounted to the appliance door. Advantages of Siemens fixed hinge can offer heavy duty softClosing doors that automatically close at an angle of less than 20° so you don't accidentally leave the door open. This hinge design holds a door weight of up to 62.5kg, gives an increased door opening angle of 115°.



Optimum conditions for all types of wine: adjustable temperature zones and humidity mode

An ideal solution for wine connoisseurs to store all kinds of wine together. Independently adjustable temperature zones enable you to store red and white wines and even premium champagne at optimal conditions without the need for a separate storage unit. Precisely separated compartments allow you to set up to three different temperature levels in the range of 5°C to 20°C and set dry or moist climate in each cooling compartment separately. By ensuring an optimum level of humidity, cork brittling or mould on your valuable bottles can be avoided effectively.



Chilled air breezes through your food on every level

Initial freshness and quality of food can be retained in the coolModul range for longer. The multiAirflow system actively distributes cooled air around the refrigeration compartment, ensuring an uniform temperature on all levels of the fridge. Foods cool more quickly when they are placed in the refrigerator – 40% quicker than in a standard fridge, with less humidity and no condensation build-up.



The perfect environment for food

The airFresh filter separates the odours, ensuring that the fridge smells fresh at all times. The filter neutralizes odours in the fridge, ensuring that different smells don't transfer between foods, while the anti-microbial filter stops the transfer of germs and bacteria.



Individual flare

Great for showcasing large collections, the premium LED lighting enables to create a unique atmosphere interiors, presenting wines in individual lightings. With five selectable light scenarios, it lets you find the optimal level of illumination you desire. Depending on the model, there are up to three compartments where lighting intensity can be regulated. Fitted flush on the top of each compartment, it is both elegant and long-lasting.



Quality you can see, difference you will feel

High-end quality is apparent in every detail of this range. The smoothness of the stainless steel reflects the light and conveys a certain sense of luxury. Wine cabinet shelves made of white oak draw your eye to the strong aesthetic, underlining the elegant interior and exterior at once. Fully extendable pyramid bottle trays with applications of solid aluminium in silver accentuate the quality further. You can showcase your premium wine collection in style.



Built-in French door refrigerator



CONNECTED BY
HomeConnect



Scan code to find out more

CI36TP02L

Features	<ul style="list-style-type: none"> • HK Energy label: Class 1 • No frost • 2 Inverter compressors • 2 cooling circuits • multiAirflow 	<ul style="list-style-type: none"> • TFT display with touchControl • Flush-folding hinge • Drawers on telescopic rails • Water filter for the automatic ice maker
Fridge Section	<ul style="list-style-type: none"> • Temperature adjustable from 2°C to 8°C • airFresh filter with antiBacteria • Super cool function with automatic de-activation • 2 height adjustable safety glass shelves • hyperFresh plus humidity-controlled vegetables drawer on telescopic rails 	<ul style="list-style-type: none"> • hyperFresh plus drawer on telescopic rails for fish and meat • 6 door bins, including 2 extra deep • LED Interior light on both sides • Eco mode • Holiday mode
Freezer Section	<ul style="list-style-type: none"> • Temperature adjustable from -24°C to -14°C • Super freeze function with automatic de-activation • Automatic ice maker with fixed water connection 	<ul style="list-style-type: none"> • Drawer on telescopic rail • Removable container • Ice cubes per day: 1.6kg • Ice cube container capacity: 3kg
Technical Information	<ul style="list-style-type: none"> • Total net capacity: 511L • Net fridge capacity: 379L • Net freezer capacity: 132L • Noise level: 42dB 	<ul style="list-style-type: none"> • Annual energy consumption: 340kWh • Freezing capacity (24hrs): 16kg • Storage time in power failure: 17hrs • Total connected load: 0.3kW (10A)
Supplied Accessories	<ul style="list-style-type: none"> • Water connection hose (3m) 	
Optional Accessories	<ul style="list-style-type: none"> • CI10Z491 Stainless steel door handle set (3pcs) • CI36Z490 Stainless steel door panels (3 pcs) • CI36Z410 Stainless steel ventilation kit • CI60Z200 Heating side kit • FI50Z000 (00740568) Ultra Clarity water filter 	
Appliance Dimensions (H x W x D)	2,125 x 908 x 608mm	
Built-in Dimensions (H x W x D)	2,134 x 914 x 610mm	
Country of Origin	Turkey	
Expert Services	<ul style="list-style-type: none"> • Product consultation with unlimited product hotline inquiry • Kitchen planning consultation with pre-installation site measurement • Professional installation 	
Recommended Retail Price	HK\$98,800	

* Indent Order

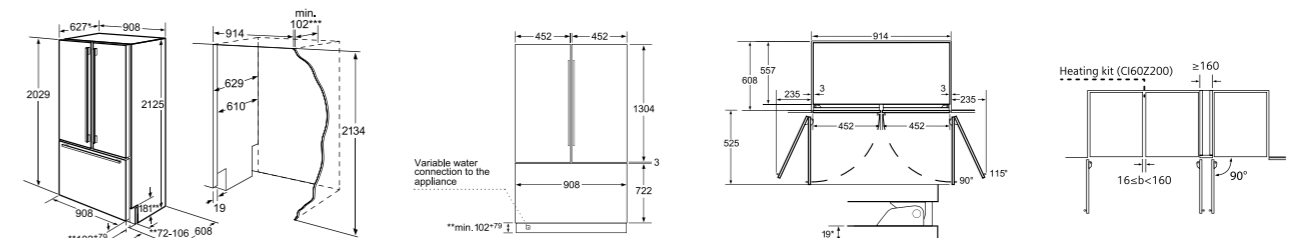

* Thickness dependent on the kitchen unit door used. 19 corresponds to stainless steel door (special accessory).

** Base adjustment

*** Wooden panel required for installation: (H x W x D) 15 x 914 x min. 102 mm

**** Socket on the side

Note 1: With all appliance combinations, the additional heating kit CI60Z200 is required to be installed between the appliances to avoid condensation when relative humidity is over 65%. This additional heating kit is not necessary if the distance between the appliances is greater than 160mm. The heating kit does not take up additional space.
Note 2: On site pre-inspection is required for the delivery and installation of coolModul appliances.

Measurements in mm

Built-in 1-door fridge



CI24RP02



Scan code to find out more

Features	<ul style="list-style-type: none"> • multiAirflow • TFT display with touchControl • Flush-folding hinge • Door right hinged, reversible • Drawers on telescopic rails • airFresh filter with antiBacteria • Temperature adjustable from 2°C to 8°C • Super cool function with automatic de-activation • 3 height adjustable safety glass shelves • Vegetable drawer on telescopic rails • hyperFresh plus humidity-controlled vegetables drawer on telescopic rails • hyperFresh premium 0C drawer on telescopic rails for fish and meat • 4 door bins, including 1 extra deep • LED Interior light on both sides • Eco mode 	
Technical Information	<ul style="list-style-type: none"> • Total net capacity: 356L • Noise level: 40dB 	<ul style="list-style-type: none"> • Annual energy consumption: 131kWh • Total connected load: 0.3kW (10A)
Optional Accessories	<ul style="list-style-type: none"> • CI10ZH10 Stainless steel door handle • FI24Z090 Stainless steel door panel • CI24Z010 Stainless steel ventilation kit • CI60Z200 Heating side kit 	
Appliance Dimensions (H x W x D)	2,125 x 603 x 608mm	
Built-in Dimensions (H x W x D)	2,134 x 610 x 610mm	
Country of Origin	Turkey	
Expert Services	<ul style="list-style-type: none"> • Product consultation with unlimited product hotline inquiry • Kitchen planning consultation with pre-installation site measurement • Professional installation 	
Recommended Retail Price	HK\$83,800	

* Indent Order

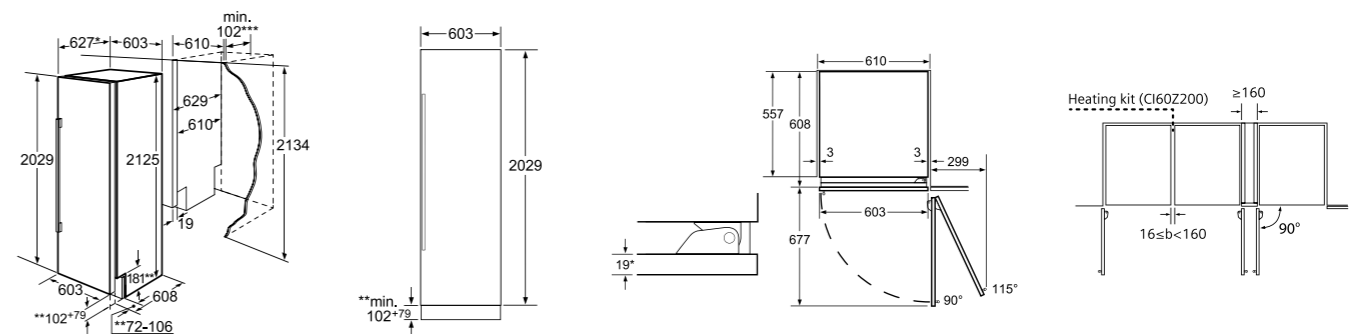

* Thickness dependent on the kitchen unit door used. 19 corresponds to stainless steel door (special accessory).
 ** Base adjustment

*** Wooden panel required for installation: (H x W x D) 15 x 610 x min. 102 mm
 **** Socket on the side

Note 1: With all appliance combinations, the additional heating kit CI60Z100 is required to be installed between the appliances to avoid condensation when relative humidity is over 65%. This additional heating kit is not necessary if the distance between the appliances is greater than 160mm. The heating kit does not take up additional space.
 Note 2: On site pre-inspection is required for the delivery and installation of coolModul appliances. Measurements in mm

Built-in 1-door freezer



FI24NP32

CONNECTED BY
HomeConnect



Scan code to find out more

Features	<ul style="list-style-type: none"> • HK Energy label: Class 1 • No frost • multiAirflow • TFT display with touchControl • Flush-folding hinge • Door left hinged, reversible • Temperature adjustable from -24°C to -14°C • Automatic ice cube maker with fixed water connection 	<ul style="list-style-type: none"> • Ice cubes per day: 1.5kg • Ice cube container capacity: 2.5kg • 2 drawers on telescopic rails • Super freeze function with automatic de-activation • 4 height adjustable safety glass shelves • 4 door bins • LED Interior light on both sides • Eco mode
Technical Information	<ul style="list-style-type: none"> • Total net capacity: 328L • Freezing capacity (24hrs): 18kg • Storage time in power failure: 13hrs • Noise level: 42dB • Annual energy consumption: 284kWh • Total connected load: 0.3kW (10A) 	
Supplied Accessory	<ul style="list-style-type: none"> • Water connection hose (3m) 	
Optional Accessories	<ul style="list-style-type: none"> • CI10ZH10 Stainless steel door handle • FI24Z090 Stainless steel door panel • FI24Z010 Stainless steel ventilation kit • CI60Z200 Heating side kit • CI60ZBL1 Large ice bucket • FI50Z000 (00740568) Ultra Clarity water filter 	
Appliance Dimensions (H x W x D)	2,125 x 603 x 608mm	
Built-in Dimensions (H x W x D)	2,134 x 610 x 610mm	
Country of Origin	Turkey	
Expert Services	<ul style="list-style-type: none"> • Product consultation with unlimited product hotline inquiry • Kitchen planning consultation with pre-installation site measurement • Professional installation 	
Recommended Retail Price	HK\$79,800	

* Indent Order

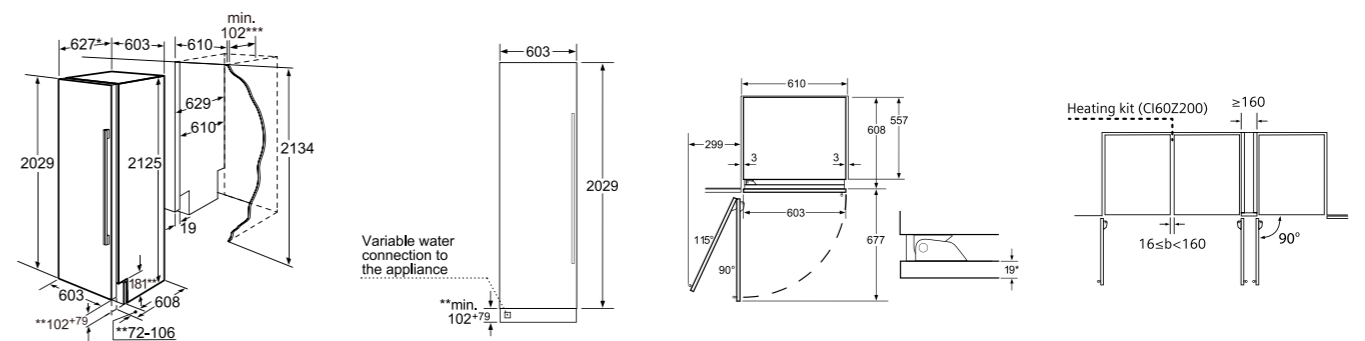

* Thickness dependent on the kitchen unit door used. 19 corresponds to stainless steel door (special accessory).
** Base adjustment

*** Wooden panel required for installation: (H x W x D) 15 x 610 x min. 102 mm
**** Socket on the side

Note 1: With all appliance combinations, the additional heating kit CI60Z100 is required to be installed between the appliances to avoid condensation when relative humidity is over 65%. This additional heating kit is not necessary if the distance between the appliances is greater than 160mm. The heating kit does not take up additional space.
Note 2: On site pre-inspection is required for the delivery and installation of coolModul appliances.

Measurements in mm

Built-in wine cabinet



CI24WP03



Scan code to find out more

Features	<ul style="list-style-type: none"> • UV protected tinted glass door • TFT display with touchControl • Three separate temperature zones, both continuously variable from 5°C to 20°C, with separate humidity level control • airFresh filter with antiBacteria • Flush-folding hinge • Door right hinged, reversible • White oak rack on telescopic rails • Presentation rack • LED Interior lights in each temperature zones
Technical Information	<ul style="list-style-type: none"> • Total net capacity: 361L • Storage: 92 bottles (0.75L) • Noise level: 42dB • Annual energy consumption: 171kWh • Total connected load: 0.3kW (10A)
Optional Accessories	<ul style="list-style-type: none"> • CI10ZH10 Stainless steel door handle • CI24Z590 Stainless steel door panel (right-mounted unit) • CI24Z690 Stainless steel door panel (left-mounted unit) • CI24Z010 Stainless steel ventilation kit • CI60Z200 Heating side kit • CI60Z300 Door lock
Appliance Dimensions (H x W x D)	2,125 x 603 x 608mm
Built-in Dimensions (H x W x D)	2,134 x 610 x 610mm
Country of Origin	Turkey
Expert Services	<ul style="list-style-type: none"> • Product consultation with unlimited product hotline inquiry • Kitchen planning consultation with pre-installation site measurement • Professional installation
Recommended Retail Price	HK\$96,800

* Indent Order

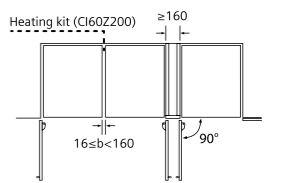
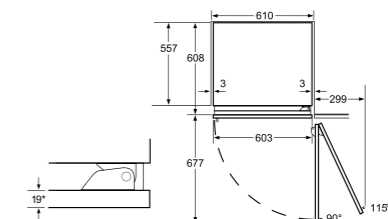
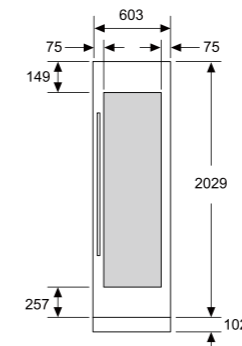
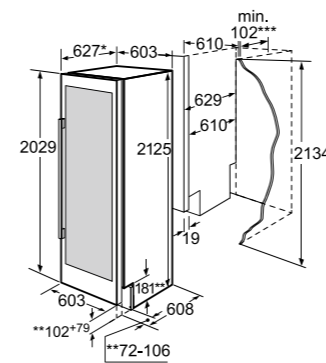

* Thickness dependent on the kitchen unit door used. 19 corresponds to stainless steel door (special accessory).
** Base adjustment

*** Wooden panel required for installation: (H x W x D) 15 x 610 x min. 102 mm
**** Socket on the side

Note 1: With all appliance combinations, the additional heating kit CI60Z100 is required to be installed between the appliances to avoid condensation when relative humidity is over 65%. This additional heating kit is not necessary if the distance between the appliances is greater than 160mm. The heating kit does not take up additional space.
Note 2: On site pre-inspection is required for the delivery and installation of coolModul appliances. Measurements in mm



Built-in wine cabinet



CI18WP03



Scan code to find out more

Features	<ul style="list-style-type: none"> • UV protected tinted glass door • TFT display with touchControl • Two separate temperature zones, both continuously variable from 5°C to 20°C, with separate humidity level control • airFresh filter with antiBacteria • Flush-folding hinge • Door right hinged, reversible • White oak rack on telescopic rails • Presentation rack • LED Interior lights in each temperature zones
Technical Information	<ul style="list-style-type: none"> • Total net capacity: 263L • Storage: 58 bottles (0.75L) • Noise level: 42dB • Annual energy consumption: 167kWh • Total connected load: 0.3kW (10A)
Optional Accessories	<ul style="list-style-type: none"> • CI10ZH10 Stainless steel door handle • CI18Z590 Stainless steel door panel (right-mounted unit) • CI18Z690 Stainless steel door panel (left-mounted unit) • CI18Z000 Stainless steel ventilation kit • CI60Z200 Heating side kit • CI60Z300 Door lock
Appliance Dimensions (H x W x D)	2,125 x 451 x 608mm
Built-in Dimensions (H x W x D)	2,134 x 457 x 610mm
Country of Origin	Turkey
Expert Services	<ul style="list-style-type: none"> • Product consultation with unlimited product hotline inquiry • Kitchen planning consultation with pre-installation site measurement • Professional installation
Recommended Retail Price	HK\$79,800

* Indent Order

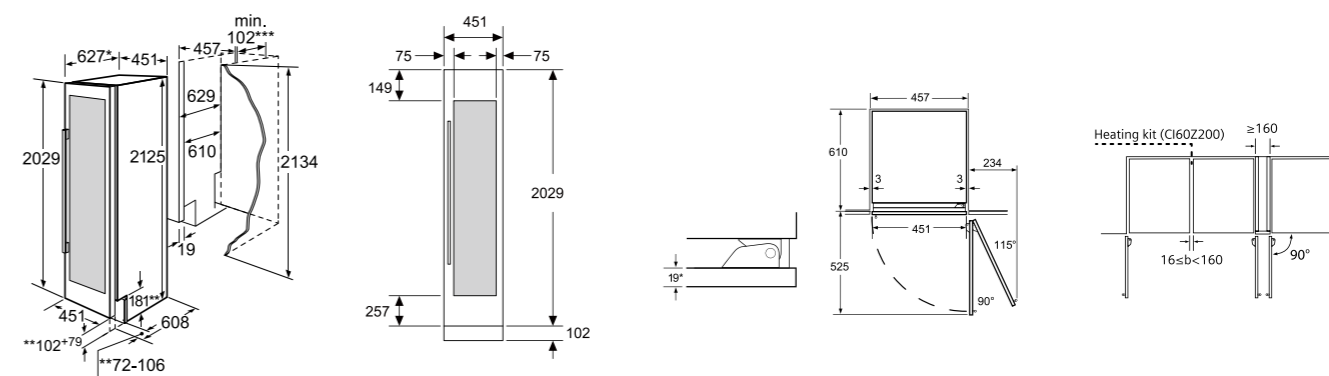





* Thickness dependent on the kitchen unit door used. 19 corresponds to stainless steel door (special accessory).
 ** Base adjustment

*** Wooden panel required for installation: (H x W x D) 15 x 610 x min. 102 mm
 **** Socket on the side



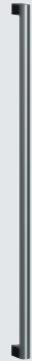

Note 1: With all appliance combinations, the additional heating kit CI60Z100 is required to be installed between the appliances to avoid condensation when relative humidity is over 65%. This additional heating kit is not necessary if the distance between the appliances is greater than 160mm. The heating kit does not take up additional space.
 Note 2: On site pre-inspection is required for the delivery and installation of coolModul appliances.

Measurements in mm





Accessories

	Model	Price (HK\$)	CI36TP02	CI24RP02	FI24NP32	CI24WP03	CI18WP03
Stainless Steel Door Handle and Panel Stainless steel door handle set (3pcs) 	CI10Z491	3,300	■				
Stainless steel door panels (3 pcs) 	CI36Z490	12,300	■				
Stainless steel door handle 	CI10ZH10	1,300		■	■	■	■
Stainless steel door panel 	FI24Z090	8,800		■	■		





Accessories

	Model	Price (HK\$)	CI36TP02	CI24RP02	FI24NP32	CI24WP03	CI18WP03
Stainless Steel Door Handle and Panel Stainless steel door panel (right-mounted unit) 	CI24Z590	10,800				■	
Stainless steel door panel (left-mounted unit) 	CI24Z690	10,800				■	
Stainless steel door panel (right-mounted unit) 	CI18Z590	8,800					■
Stainless steel door panel (left-mounted unit) 	CI18Z690	8,800					■

Accessories

	Model	Price (HK\$)	CI36TP02	CI24RP02	FI24NP32	CI24WP03	CI18WP03
Stainless Steel Ventilation Kit Stainless steel ventilation kit 	CI36Z410	2,800	■				
Stainless steel ventilation kit 	CI24Z010	2,800		■		■	
Stainless steel ventilation kit 	FI24Z010	2,800			■		
Stainless steel ventilation kit 	CI18Z000	2,800					■

Accessories

	Model	Price (HK\$)	CI36TP02	CI24RP02	FI24NP32	CI24WP03	CI18WP03
Heating Side and Connection set for Side by Side Installation Heating side kit 230V EU Version 	CI60Z200	5,800	■	■	■	■	■
Special Accessories Ultra Clarity water filter 	FI50Z000 (00740568)	1,130	■		■		
Large ice bucket 	CI60ZBL1	580			■		
Door lock for wine cabinet 	CI60Z300	1,800				■	■

Some of the appliances pictured in this catalogue are not available in Hong Kong.

Model numbers and specifications are for reference only and are subject to change without prior notice. Siemens is continuously seeking to improve specification, design and production of its appliances and alterations may take place regularly. All descriptions and installation diagrams are intended as a guide only. For additional technical information, full dimensional and installation details, please refer to the instruction manual supplied with the appliance. Electrical and gas connections should only be made in accordance with the regulations of the national authorities.

Right of technical modification reserved, delivery subject to availability, colors of actual products may vary from illustrations.

©2022 by BSH Home Appliances Ltd. Reproduction, complete or in part, only with the express permission of the publisher.
Printed in Hong Kong. 08.2022

Your dealer will be able to provide you with reliable information.

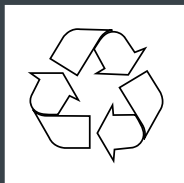

Scan
QR code
to browse
brochure
online



BSH Home Appliances Limited

BSH Home Appliances Group is a Trademark Licensee of Siemens AG

Siemens Home Appliances Experience Centre
5/F, Club Lusitano, 16 Ice House Street, Central, Hong Kong (main entrance on Duddell Street)
Customer Contact Hotline: 2565 6151 (Hong Kong) /
0800 030 (Macau local call only)
E-mail: siemens.hk.showroom@bshg.com

www.siemens-home.bsh-group.com.hk



facebook.com/SiemensHomeHongKong