

SIEMENS



創新家電科技

雪櫃

Home appliance innovations

Cooling

German
Technology



2
years

Warranty



Discover exciting possibilities.
siemens-home.bsh-group.com.hk

The future moving in.

Siemens Home Appliances



iSensoric將感應技術應用於
智能家居 豈止於非凡生活

iSensoric: the sensor-technology
for an intelligent home.
For a life less ordinary.

西門子為德國享譽盛名的家電品牌，品牌的卓越科研成就源自其創意、完美和精確度，都是具有超過170年歷史的西門子品牌價值。

西門子不斷應用新科技，是行業中少數極重視家電環保節能的品類。西門子家電的嶄新技術令人雀躍。

Siemens is the renowned German brand. The brand stands for outstanding engineering executed with creativity, precision and perfection – values that have characterised the Siemens brand for more than 170 years.

The continual application of new technologies sets Siemens Home Appliances as a benchmark on resources efficiency for the industry. Siemens appliances make technical progress exciting.



產品實物之顏色可能與相片有輕微差異。
Colors of actual products may vary from illustration.

圖片只供參考，個別產品在香港或未有銷售。
Certain appliances shown in this catalogue may not be available
in Hong Kong.



“...應透過自身的發明和創業理想，去提升人類知識及改善人類生活。”
“...of an enterprise that, through its own inventions and its entrepreneurial vision, contributes to enhancing the knowledge and well-being of humanity.”

維爾納·馮·西門子
Werner von Siemens

我們不只是追求願景 — 我們令夢想實現
We don't just pursue visions –
We make dreams a reality.

當我們公司創辦人維爾納·馮·西門子在十七歲去到柏林的時候，他只有一個夢想“應透過自身的發明和創業理想，去提升人類知識及改善人類生活。”

經過170多年，西門子作為德國家喻戶曉的品牌，活動橫跨整個電器行業。品牌將西門子先生永恆的願景“為生民立命”人格化。自1967年以來，所有西門子家電產品已由博西華家用電器有限公司管理。

When the founder of our company, Werner von Siemens, came to Berlin at the age of 17, he had nothing more than just a dream “of an enterprise that, through its own inventions and its entrepreneurial vision, contributes to enhancing the knowledge and well-being of humanity.”

For more than 170 years, Siemens is a German industrial and technological brand with activities spanning the entire breadth of the electrical engineering industry. The brand personifies the timeless vision of Mr Siemens: “progress in the service of mankind”. Management of the home appliances business under the Siemens brand has been exercised by BSH Hausgeräte GmbH since 1967.



都市生活

Metropolitan Living

西門子家電的整體感覺和外觀是受到世界大都會所啟發——一直站在創新技術的尖端，完美無縫地融入大都市的生活方式。

通過消費者所嚮往的個人或專業上的成就所見，我們於都市風格的現代化演繹，投射出信心並反映出尊貴的社會地位。

The look and feel of Siemens Home Appliances is inspired by the large metropolises of the world, always at the forefront of innovation and blending seamlessly into the metropolitan way of life.

The modern interpretation of urbanity projects confidence and reflects high social standing through the personal as well as professional achievements to which consumers aspire.

西門子家電 為您展現未來 Siemens. The future moving in.

致力發展 綠色科技

一直以來，西門子家電努力拓展環保技術，為您及下一代締造優質的綠色生活。透過高效率的壓縮機、改良的隔熱裝置、精選的隔熱物料、優質的蒸發器，以及低耗電量的內置冷凍裝置，讓雪櫃的用電量大幅下降。

Dedicated to development, green science and technologies

Siemens Home Appliances is continually striving to expand its environmental protection technologies to create a high-quality, eco-friendly lifestyle for you and your children. Our refrigerator's electricity consumption has dramatically reduced, thanks to innovative technologies such as high-efficiency compressors, improved insulation, well-selected vacuum panel, optimised evaporator and energy-saving refrigerating devices.

卓越能源效益表現 比一級更優勝

大部份西門子雪櫃榮獲1級香港能源效益標籤及歐洲A+甚至A++級能源效益級別，成績有目共睹。A+級的西門子雪櫃比A級節省約25%耗電量，而A++級的比A級更節省達40%，務求為保護地球資源及持續發展做到最好。

Outstanding energy efficiency even better than FIRST CLASS

In recognition, most of the Siemens refrigerators are honoured with first class Hong Kong Energy Efficiency Label and at least Class A+ or even A++ of European Energy Class. Refrigerators that achieve class A+ reduce electricity consumption by a further 25% compared to Class A, while A++ grade reduce even up to 40% of energy. This achievement serves to protect the resources of our planet and encourages sustainable development.

ENERGY LABEL	
能源標籤	
more efficient 效益較高	Grade 1
1	
2	
3	
4	
less efficient 效益較低	5
Annual Energy Consumption (kWh)	232
Fresh Food Volume (litre)	216
Frozen Food Volume (litre)	64
Refrigerating Appliance Brand	西門子 Siemens
Model	KR20E0901
Reference Number / Year	17143/2014
Information Provider	EMSD Home Appliances Ltd. 機電工程署

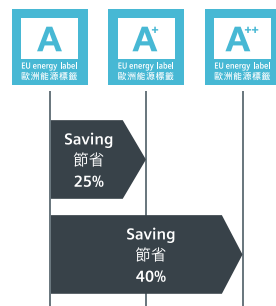



品質監控 信心保證

為確保每部西門子雪櫃的性能及功效都得到最佳的保證，雪櫃出廠前會就安全、噪音以及功能進行嚴格的抽樣測試，如以最低溫度運作24小時、托架負重20公斤、門鉸開合測試200,000次等。為了顧客得到更好的保障，西門子除提供全線產品2年全機保養外，所有西門子雪櫃的壓縮機均設有5年保養，如此完善的服務確實為優質產品的信心保證，讓您用得安心。

Quality assurance

To ensure optimum performance and efficiency, Siemens refrigerators undergo rigorous factory testings. For instance, a 24-hour operation test with machine's maximum tolerance, a 20kg load weight test on shelves and a door-hinge test for 200,000 times. Beyond a 2-year full coverage warranty on all products, a 5-year warranty is provided for the compressor in all Siemens refrigerators. These extensive warranties assure top quality of our product and provide you with complete peace of mind.



綠色科技 響應環保

採用R600a環保雪種的西門子雪櫃，令全球暖化潛值為「極低」。西門子同時亦購入雪種回收器放置回收雪種以減少溫室氣體的排放量。回收的雪櫃均由政府認可的回收機構棄置，從而對環境的影響減到最低。致力與您一起為綠色地球出一分力。

Green technologies – contribute to environmental protection

Siemens uses refrigerant R600a, which has a very low Global Warming Potential (GWP). To eliminate greenhouse gas emission, Siemens invested in a refrigerant recycling machine to collect the refrigerant from old refrigerators. Moreover, a Government authorised recycling organisation is appointed to take care of the remaining parts. By minimising the impact of disposal, Siemens emphasizes the importance of a healthier and greener environment for our future to you and our world.



German
Technology



建築美學

西門子家電提供超卓精準度的技術和風格品味的保證，以滿足高生活標準的消費者——他們都是一直追求進步、不願意在產品性能上或設計上原地踏步的消費者。

為滿足消費者對可持續發展生活空間於視覺上的吸引力和經歷得起時間洗禮的渴望，我們的設計語言包含幾何形狀和直線美學。它們都描繪了一種富有現代感，卻又能歷久不衰的風格。

Architectural Design

Siemens Home Appliances deliver technical precision and stylistic assurance that respond to consumers with high living standards, who are unwilling to compromise on performance or design.

The geometric design language with its straightlined aesthetics portrays a modern, yet lasting style that fulfils the consumers' desire for sustainable living spaces that are visually appealing and future-proof.



精湛德國科技

豐富的經驗、堅定的思維方式和持續追求效率是西門子每項行動的核心，使這個品牌能夠持續提供質量和可靠性的保證。

西門子家電一向致力發揮被全球所公認的德國工藝，令西門子家電能為消費者提供最高水平及優質的產品。

German engineering excellence

Considerable experience, a determined mindset and effectiveness at the core of each action enable Siemens to provide assurance on quality and reliability.

Dedication to the globally recognised virtues of German engineering enables Siemens Home Appliances to provide consumers with the highest level of excellence.

無與倫比、專業至誠的西門子家電服務 Siemens Total Home Solution: No one knows your appliances better



歡迎進入西門子的家電世界，享受西門子家電獨一無二的全面服務！只要選用西門子家電，我們一班專業的顧問和服務團隊都為您作出貼心的售前售後服務，保證您能夠安心享受西門子家電帶來的無與倫比體驗，為生活締造無限可能。就讓我們與您一起開展旅程，了解西門子家電由生產、送貨，以至售後各種超乎您想的服務吧！

Embrace the full customer service experience that no other can match. Customers at Siemens can now enjoy Siemens Total Home Solution, the full range of professional service and consultancy designed to cover every customer's pre-sales and after-sales needs. Let us take you on a journey, from when our products come out from the production plants, to arriving at your home and beyond.

屢獲殊榮，信心保證

西門子家電領導業界，建基於我們對品質與工藝的堅持。所有西門子家電在推出市場前都必須符合嚴格的品質檢控，再經專業品質監控人員於工廠進行嚴謹的審核及測試，包括評估家電壽命及最高耐力的24小時壓力測試、門鉸耐力測試及負載力測試等，確保產品達到甚至超越國際標準，以及客戶的期望。只有符合所有測試水平的家電方可推出市場，客戶自然用得安心又放心。

Award-winning quality you can feel

Siemens Home Appliances leads the industry with our commitment to quality and craftsmanship. Our products are designed and made meeting the most stringent set of requirements. From 24-hour operation stress tests to evaluate our appliances' lifespan and maximum tolerance, to extensive door hinge durability and shelf load tests, we go the extra mile to ensure our products meet and exceed all related international standards – as well as your expectations – at the moment they leave the assembly lines.



安心之選，無憂享受

西門子家電至臻完美，為令每位客戶可以無後顧之憂地享用各款產品，為全線產品提供選購後至少2年的全機保養。另外，所有西門子雪櫃的壓縮機均有5年保養，而個別型號洗衣機及抽油煙機如備有iQdrive無刷式變頻摩打及洗碗碟機內桶防鏽穿的保養期為10年。同時，客戶可按需要延長貨品保養期，務求讓每位客戶用得愜意安心。

Complete peace of mind

We pride ourselves in providing the best of the best. We back up our confidence by offering our customers 2-year full warranty for our entire product portfolio. In addition, we offer 5-year warranty for the compressor installed in our refrigerators; and a 10-year warranty for iQdrive motor of the washing machines & cooker hoods and the protection against rust-through in the inner tub of all dishwashers. Customers may even opt to extend their warranties to enjoy our services for a longer period if they desire. These extensive offers afford the luxury for all our customers to enjoy a complete peace of mind when using our appliances.



以客為本，配合生活所需

家電有異於一般的日常生活用品，形同長遠投資。我們深諳顧客對家電產品的實用性之重視，故歡迎客戶親臨Siemens Home Appliances Experience Centre，隨意試用及體驗一下所有產品；我們更會安排專業的產品顧問，專誠為您提供協助或解答您對家電的疑問，以及親身為您示範各產品的用法，讓每位客戶在購買之前都能對產品有更透徹的了解。

See it with your own eyes

Shopping for appliances is not like shopping for groceries. It's more like an investment, and seeing the actual products helps one make a better decision. Our trained professional consultants at Siemens Home Appliances Experience Centre are eager to take your questions and do the product demonstrations to make you fully understand the product capabilities. Let us show you the power of our products in person.



體貼的售前專業諮詢服務

為了讓每位客戶能安心享用我們的產品，客戶甚至可在選購之前，安排專業技術人員親臨府上，就有意購置的嵌入式、獨立式家電進行實地檢查，並提供專業安裝諮詢服務。我們樂意在客戶購置產品後，為客戶測試水壓及進行其他相關測試，如有需要更會提供減壓器#或接地電壓插座#。以客為尊，全心全意為您做到最好。

Get a consultation visit by professionals ... before you even get your appliances

To make sure you get to enjoy our product to the fullest extent, we can send our professionals to you for a consultation visit and advise you on the installation of built-in home appliances or freestanding home appliances even before you have bought it! We are also happy to help you test your home's various specifications such as water pressure, provide you with tools or accessories such as pressure regulator# after you have finalised your purchase and offer advice on changing your RCD adaptor#. You may ask: Why? Simply because we think you'd like the extra effort we put in.



*受推廣條款及細則約束 Subject to the promotional terms and conditions



高效率的送貨安裝服務

購置新家電令人雀躍萬分，總希望能縮短等候時間，盡快安裝。為了讓每位客戶能盡快享用產品，西門子家電的送貨及安裝團隊最快可於接到訂單的第二天將貨品送抵府上(周日及公眾假期除外)[^]，安置妥當。

Have it at your doors, pronto

To make sure you get to use your new purchases as soon as possible, Siemens Home Appliances has its own logistics and installation staff to deliver and install your new products on the next day after confirmation of your order[^] (except Sundays and public holidays).



安寢無憂，免費家電借用服務

如果您的家電需要維修，我們可為您提供測試及維修安排(服務時間為每日上午九時至晚上六時，周日及公眾假期除外)，如需維修洗衣機或雪櫃，歡迎隨時聯絡我們；西門子家電亦會在維修期間為客戶提供免費家電借用服務*，減低維修家電對生活造成的影響。

Disruption-free repairs

Customers may also schedule for our consultation or repair service by professionals to check if their products require service (daily service hours from 9:00am till 6:00pm, except Sundays and public holidays). If any of your Siemens washing machines or refrigerators malfunctions, simply contact us and we will provide you one of our on-loan products* free-of-charge while we repair yours. This allows your daily routines to remain undisrupted while we get everything inside your appliance back in working order again.



[^]視乎時間表安排而定 Subject to time schedule availability

*視乎存貨而定，或會因產品類別而有所不同 Subject to stock availability, offer may differ from one product category to another



從外到內，一應俱全

客戶如有需要選購西門子產品的配件，我們都樂意效勞。西門子設有直送服務，將配件直接送到府上。

Everything that should do with our products, we deliver

Sometimes, our customers may want to get spare or extra parts to mould their user experience to their liking. The good news? As long as it is a part we made for our products, we will deliver it straight to your doorsteps.



以您為先，提升服務質素

如有查詢，歡迎隨時致電顧客服務熱線，我們的客戶服務專員樂於聆聽您的意見及協助。您亦可透過電郵或網上顧客服務平台與我們聯繫，為您解答查詢、登記家電保養或預約維修、安排保養續用，以及在網上細閱用家貼士。詳情可瀏覽 siemens-home.bsh-group.com.hk 了解更多。

We're just a phone call away

Whenever you feel like talking to us, call us and speak to one of our customer service representatives. You may also contact us online via email or our 24-7 customer service portal. In addition to getting answers for your questions, you may also register for warranty, schedule for on-site repairs, request for maintenance contract renewal and read the user tips online. Visit our website siemens-home.bsh-group.com.hk to learn more.



iSensoric能讓新鮮食物保鮮更長

Fresher food for longer with iSensoric



西門子iSensoric是全感應控制的智能技術，以自動檢測，計算和控制整個保鮮過程。豈止於非凡生活。

iSensoric from Siemens is the sensor-controlled intelligence that stands for automatically detecting, calculating and controlling the whole process. For a life less ordinary.

freshSense

freshSense感應器能自動調節不同時刻的溫度變化，例如當新鮮食物被貯存起來時，freshSense能對一瞬間的溫度變化作出相應調整。這樣雪櫃內的溫度就能保持在最佳範圍內，讓您的食物保持更長的新鮮和美味。

freshSense

The freshSense sensors activate the moment a change in temperature is set, for example when products are stored away, and compensates for this change in an instant. Therefore the temperature always remains within the optimum range and your food stays fresh and delicious for longer.



無霜技術

西門子iSensoric雪櫃都配備了智能感應控制技術，以免卻解凍溶雪的麻煩。感應器會檢測雪櫃內的濕度和霜凍產生程度，進行定期和自動溶雪而不需要關閉雪櫃。因此，雪櫃不會形成冰雪，以長效保持高能源效益。

noFrost Technology

Siemens fridges with iSensoric are equipped with intelligent sensor-controlled technology to save the hassle of defrosting the freezer. The sensors measure the degree of humidity and any frost production, the appliance is periodically and automatically defrosted without the need to turn off the appliance. Also, ice no longer forms inside of the refrigerator, the appliance's energy consumption remains consistently low.



輕觸式控制

輕觸式控制顯示屏靈敏度高，只需輕輕觸控按鍵，雪櫃的所有功能如溫度，Super冷藏/冷凍功能和節能模式便可立即設定。加上輕觸式控制顯示屏是iSensoric通信樞紐，將設定和各感應器數據控制其它功能。

touchControl

The touchControl display is with the highly sensitive sensors, even the slightest touch of the control, all the functions of the refrigerator such as temperature, super function and eco mode can be immediately set. Furthermore, the touchControl display is the communications hub for iSensoric, as this is where the data is collected from the various sensors for controlling other functions.



西門子保鮮系統hyperFresh：長效保鮮技術

Siemens freshness system technology – hyperFresh



hyperFresh premium 0°C

hyperFresh premium 0°C保鮮格令水果和蔬菜得到最佳濕度。利用0°C保鮮格，魚類和肉類因此可以貯存在完美的溫度。從而保存豐富維他命，保持口感爽脆，香氣馥郁且更有營養。

hyperFresh premium 0°C

The hyperFresh premium 0°C drawers regulate how much humidity the fruits and vegetables receive. With the 0°C drawer, fish and meat can also be stored in the perfect temperature. Thus preserving precious vitamins, keeping it longer crisp, flavorsome and more nutritious.



hyperFresh plus

hyperFresh plus保鮮格保持蔬菜，沙律和水果新鮮全賴濕度控制系統，保鮮格不斷保持食物乾爽，並有助保留礦物質和營養。

hyperFresh plus

The hyperFresh plus drawers keep vegetables, salad and fruits fresh much longer by controlling the internal humidity; the compartment keeps food from drying out and keeps minerals and nutrients.



* hyperFresh 0°C保鮮科技是指雪櫃內某個儲藏室處於一個相對穩定、獨立，且接近0°C的溫度狀態；並能維持該儲藏空間內一定的濕度，使食物長久保鮮得以實現 - 讓食物處於既不結冰又長久新鮮的保鮮狀態。

hyperFresh 0°C freshness technology means a storage compartment temperature is relatively stable, independent and close to 0° C; and maintains a certain humidity in the storage space, so that the food can be stored in an ultimate fresh environment – no ice formation on food and stays fresh for longer.



hyperFresh

波浪紋底部設計允許冷空氣流經水果和蔬菜。看得見的質量和新鮮感覺一目了然。

hyperFresh

The rippled bottom allows cool air to circulate around your fruits and vegetables easily. As a result, you can see the quality and feel the freshness.



hyperFresh (plus) $\diamond 0^{\circ}\text{C}$

hyperFresh (plus) $\diamond 0^{\circ}\text{C}$ 保鮮格確保魚類和肉類在最理想接近 0°C 下保持新鮮。為創造理想的保鮮環境，這個區域的溫度比周圍冷藏室的溫度略低約 $2-4^{\circ}\text{C}$ 。而且分開保鮮格貯放避免難聞氣味轉移。

hyperFresh (plus) $\diamond 0^{\circ}\text{C}$

The hyperFresh (plus) $\diamond 0^{\circ}\text{C}$ drawers ensure that fish and meat stay fresh in ideal conditions near 0°C . To create these excellent freshness conditions, the temperature in this zone is around $2-4^{\circ}\text{C}$ cooler than the rest of the refrigerator. The separate compartments also avoid unpleasant odour transfer.





完美環境貯存新鮮食物

The perfect environment for fresh food

您需要新鮮食材煮出好菜式。西門子保鮮系統保存食物新鮮更方便靈活，所以菜式無論任何時刻總是美味可口。
 You need fresh ingredients for good meals. Siemens' freshness system make keeping food fresh easy and flexible, so meals are always delicious regardless of when you find the time to shop.

生果和蔬菜 Fruit & Vegetables

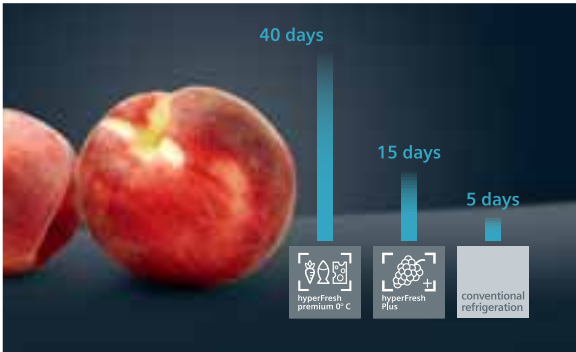

魚類和肉類 Fish & Meat

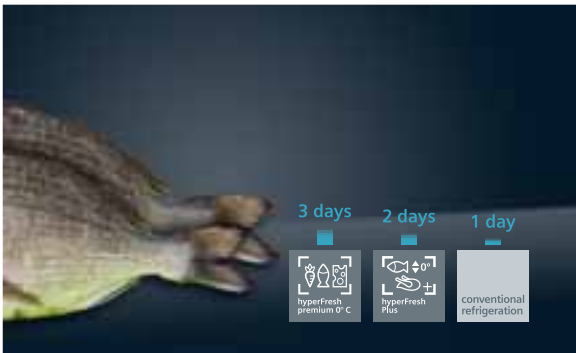

* 內部測試與現有保鮮系統和過往型號之比較。
 In-house test compared with current freshness system and previous models.

iSensoric 智感零度 無霜多門雪櫃
iSensoric no frost French door refrigerator



顯赫非凡設計和功能

Distinguished luxury in design and function



IZA抗菌過濾器

能分解氣味並確保雪櫃內的食材衛生。IZA抗菌過濾器具有抗菌和防霉功能，能有效去除雪櫃內高達99.99%*的細菌。所以雪櫃不但能保持空氣清新，更能令雪櫃衛生乾淨整潔。

IZA airFresh filter

The IZA airFresh filter separates smells and ensures the food hygiene in the refrigerator. With its antibacterial and anti-mould functions, the refrigerator can remove bacteria up to 99.99%*. So your refrigerator not only smells fresh at all times, but always looks hygienically clean and tidy.



3D層層出風系統

送風採用iSensoric智能技術優化冷藏室、hyperFresh premium 0°C保鮮室和冷凍室內的空氣循環，確保整個雪櫃每層都溫度均勻。無論您放置食材於任何位置，精確的冷量分配都可以快速地冷卻食材。產品後壁設有多個隱藏式出風口，配合製冷系統將冷空氣均勻地送到每個區域。

3D multiAirflow System

Airflow works with iSensoric technology to optimise the air circulation within the fridge, hyperFresh premium 0°C drawer and freezer compartments to ensure even cooling throughout the appliance. This means wherever you place your groceries it will cool them quickly no matter where they are placed. The back wall of the appliance has hidden open vents which work with the cooling circuit to draw cold air into each compartment.



矚目LED照明體驗

明亮且不可見的LED燈照系統明亮地照亮整個雪櫃。LED燈同時為hyperFresh premium 0°C保鮮室提供理想的照明。照明系統是防眩目及漸亮式設計，亮度可以精確調節到您想強度。

Premium LED lighting concept

Brilliant and invisible LEDs brightly illuminate the entire fridge compartment. An LED spotlight also provides ideal lighting in the hyperFresh premium 0°C drawer. Lights are anti-dazzling with soft start design, the brightness can also be precisely adjusted to the desired intensity.



* 經中國家用電器檢測所及廣東省微生物分析檢測中心測試，產品能有效去除高達99.99%的大腸桿菌和金黄色葡萄球菌，防霉等級為0級，表示具有抗霉菌作用。測試報告WCI-18-30455 (13 Sept. 2018)和2017FM03509R03D (5 Jun. 2018)。

Up to 99.99% reduction on Escherichia coli, Staphylococcus aureus and ability to resist mould attack. – test WCI-18-30455 (13 Sept. 2018) at China Testing & Inspection Institute for Household Electric Appliances and test 2017FM03509R03D (5 Jun. 2018) at Guangdong Detection Center of Microbiology.



hyperFresh

premium
0°C

0°C

全面升級hyperFresh premium 0°C保鮮室

全新法式多門雪櫃採用嶄新iSensoric操作概念。設定溫度和濕度從未如此簡單方便，透過抽屜門把手觸控顯示屏以智能感應控制濕度。兩個40公升可拆卸保鮮盒及金屬伸縮導軌帶來真正的豪邁氣派，智能感應出最佳的濕度狀態使食物保持原有新鮮*。



The new, giant hyperFresh premium 0°C freshness drawer

The new French door refrigerator features a new iSensoric operating concept. Thanks to integrated handle displays with motorized humidity control operated by touch, setting the temperature and humidity level have never been easier. The metal telescopic rails with two 40 litre removable boxes are pure luxury, with the added benefit that the optimal humidity level keeps food fresh for longer*.

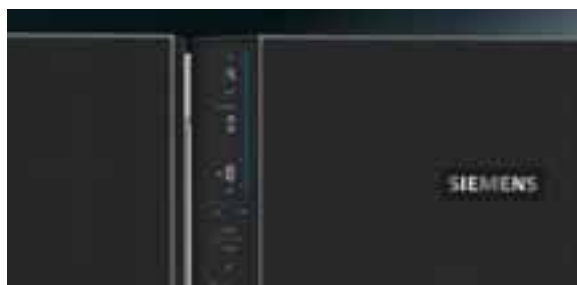

鬼斧神工的設計和更大的容量

憑藉令人驚嘆的黑色玻璃面和嵌入式弧形手柄設計，雪櫃不僅為日常貯存使用提供彈性，而且更大大提高了便利。寬敞的對開門設計和位於低位置符合人體工程學的抽屜，讓每日提取食物變得更加容易。更大的貯存容量更是讓人滿意。

Superior design and a larger volume

With its stunning black glass and integrated curved handles designs, the refrigerator isn't just flexible in everyday use, it's also extremely convenient. Daily access to food couldn't be easier thanks to the generous double doors and ergonomically positioned drawers on the lower level. And best of all, the larger usable volume leaves nothing to be desired.

精確，簡單和直接

所有雪櫃的功能均可透過雙櫃門輕觸式電子顯示屏設定。您可即時設定雪櫃功能，如溫度，濕度水平和eco節能模式。此外，輕觸式控制顯示屏是iSensoric的通信樞紐，將設定和各感應器數據控制其他功能。冷藏室，hyperFresh premium 0°C保鮮室和冷凍室溫度可單獨控制，配合真正需要。

Precise, easy and intuitive

All refrigerator functions are set with a gentle touch using duo indoor electronic LED displays with touchControl. The functions of the refrigerator such as temperature, humidity level and eco mode can be immediately set. Furthermore, the touchControl display is also the communications hub for iSensoric, as this is where the data is collected from the various sensors for controlling other functions. For more convenience, the fridge, hyperFresh premium 0°C drawer and freezer can be controlled separately.

* 與普通或自身的冷藏室相比，貯存在hyperFresh premium 0°C保鮮室的食物可有效延長食物保鮮期。菠菜貯存在高濕度設置的hyperFresh premium 0°C保鮮室得到更長的保鮮期，減少重量損失和維生素C損失。枸杞和奶粉貯存在低濕度設置的hyperFresh premium 0°C保鮮室得到更長的保鮮期，增重率得到較小變化。奶粉氧化程度和細菌含量均較低當貯存在低濕度設置的hyperFresh premium 0°C保鮮室。- 經中國家用電器檢測所測試WB-18-106(2018年3月5日)

FFood stored in hyperFresh premium 0°C drawer give a longer life span comparing to normal fridge compartment. Spinach received a longer shelf life, less weight loss and Vitamin C loss in hyperFresh premium 0°C drawer with high humidity setting. Wolfberry and milk powder received a longer shelf life, less weight gain in hyperFresh premium 0°C drawer with low humidity setting. Milk powder recorded less oxidation and lower bacterial content when it stored in hyperFresh premium 0°C drawer with low humidity setting. - Test WB-18-106 (5 Mar.2018) at China Testing & Inspection Institute for Household Electric Appliances.

法式多門無霜雪櫃 French door refrigerator



正式發售 Available in
Q2 2019

時尚黑晶型玻璃門
Sleek black glass door

KF86FPB2A

系列 iQ Class	iQ700
容量(總/淨 升) Volume (Gross/Net L)	540 / 426
保鮮格容量(淨 升) Fridge volume (Net L)	359
冷藏室 / hyperFresh premium 0 °C容量 (淨升) Fridge / hyperFresh premium 0 °C volume (Net L)	279 / 80
冰格容量(淨 升) Freezer volume (Net L)	67
冷凍功能(每日公斤) Freezing capacity (kg/24hrs)	14
環保雪種 Environmentally friendly refrigerant	R600a
歐洲能源效益標籤 EU energy efficiency	A+
香港能源效益標籤 HK energy label	1
變頻式壓縮機 Inverter compressor	■
櫃外LED功能顯示屏 Exterior LED multi-function display	■
關門提示 Door close reminder	■
控制面板安全鎖 Safety child lock	■
特殊功能 Special functions	節能、保鮮、假日模式 eco, fresh, vacation modes
保鮮格(冷藏室) Fridge compartment	
Super冷藏功能 Super cool setting	■
hyperFresh 0 °C保鮮室連2個保鮮盒 (iSensonic智感濕度控制) hyperFresh premium 0 °C drawer with 2 flexible boxes (with iSensonic humidity control)	■
IZA空氣過濾器 IZA airFresh filter	■
3D層層出風 3D multiAirflow	■
觸目LED櫃內照明 Premium LED Interior lighting	■
強化玻璃層架(可調高度) Tempered glass shelves (height adjustable)	■
保鮮格連2個保鮮盒(裝有拉趟導軌) Fresh drawer with 2 flexible boxes (with telescopic rail)	■
自選保存格和蛋格 Flex box and egg tray	■
冰格(冷凍室) Freezer compartment	
Super冷凍功能 Super freeze setting	■
抽屜式冷凍保存格 Pull out drawer with extension rail system	2
有蓋冰粒格 Ice cube tray with lid	■
尺寸 Dimensions[▲]	
尺寸(厘米) Dimension (cm) (H x W x D)	183 x 81 x 73.6
尺寸(吋) Dimension (inch) (H x W x D)	72 x 31.9 x 29
原產地 Country of origin	中國 China

[▲] 廚櫃內安裝建議預留最少通風位，高：90mm，兩側：最少25mm每邊，背：50mm。雪櫃門鉸須設於廚櫃外。

[▲] Recommended min. ventilation space for built-in installation, Top: 90mm, Sides: min. 25mm each, Back: 50mm. Door hinge should be placed outside the cabinet.

客戶可享有免費上門睇位服務一次，請向銷售人員查詢。Please consult sales consultant for a free on-site inspection.

香港和澳門地區暫時未能支援Home Connect功能。Home Connect function is currently unavailable in Hong Kong and Macau region.

雙製冷對門式雪櫃 coolDuo side-by-side refrigerator



coolDuo雙製冷對門式雪櫃系列均秉承西門子雪櫃的一貫優點與特質，而且更精益求精，不斷求進。

coolDuo side-by-side refrigerators offers stunning features and benefits as Siemens other cooling series, and even more.

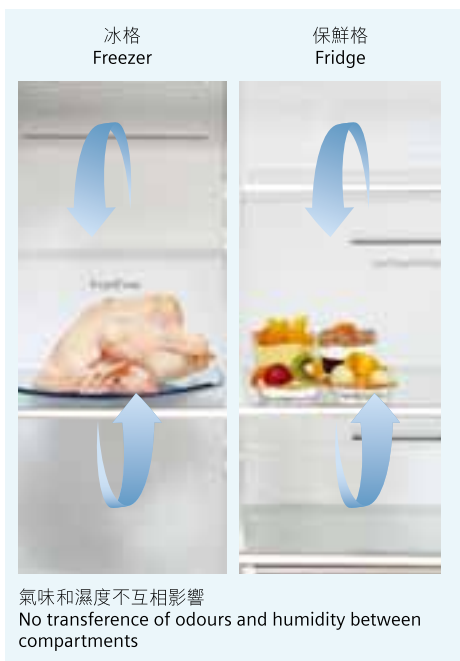

雙製冷系統

保鮮格及冰格由不同的冷凍裝置所管理，加上獨立的溫度調控裝置，確保兩者之間的氣味和濕度不會互相影響，令不同的食物均得到最適合的存放環境。

Two cooling systems

The fridge and freezer are powered by separate evaporators and cooling circuits, together with independent temperature control to make sure that no transference of odour and humidity occurs between the fridge and freezer compartments. As a result, all kinds of food can be preserved in the most suitable condition.



掃描此QR碼了解更多雙製冷系統
Scan our QR code to discover more
about two cooling systems

變頻壓縮機

西門子智能變頻技術是iSensoric和變頻壓縮機的智慧結合。感應器會不斷監測雪櫃中的溫度和濕度變化，例如在打開門時或將熱的食物貯存於雪櫃內都會使雪櫃內溫度產生變化。變頻壓縮機接收此信息及對其需要溫度作出適應調節，能源效益和寧靜無庸置疑。

Inverter compressor

The intelligent inverter technology is a clever combination of the inverter compressor and iSensoric. The sensors register every slight change in temperature and humidity inside the refrigerator, e.g. when the door is opened or warm foods are stored. The inverter compressor receives this information and adapts its need to cool food intelligently, energy-efficiently and incredibly quiet.



LCD控制顯示屏

置於櫃門上的LCD控制顯示屏操控簡單清晰，讓您輕鬆使用雪櫃的每個功能。

In-door LCD display

The sophisticated design and user-friendly electronics gives you easy control of all functions on the touch panel.

極大容量存放新鮮食物

西門子對門式雪櫃特設偌大儲存空間及高靈活性的間隔，包括設有轉動裝置的易升降玻璃層架、冰格特大儲存格等，助您存取食物更方便，保鮮空間亦能靈活盡用。

High storage capacity for fresh food and good health coolDuo refrigerators are designed with ample space and flexibility. The easyLift glass shelf with rotary turning mechanism, the bigBox in freezer compartment all play a part in maximising net storage capacity for preserving fresh food.



冰格特大儲存格 bigBox



易升降玻璃層架 easyLift glass shelf



自動製冰製水器

- 可預設冰粒、碎冰或冷水三個不同模式，輕輕一觸按鈕即可隨心享用。
- 自動製冰功能均附設濾水器，自來水會經過濾水器才進入製冰箱。
- 製冰器出口設有LED燈，除方便照明之外，更增添雪櫃的美感。

Automatic ice & water dispenser

- It can be preset to one of three different modes: ice cubes, crushed ice or cold water. At a gentle touch of the button, you can enjoy whichever you most desire.
- The ice dispenser function equips with a water filter, water flows through the filter before passing through the dispenser system.
- LED lighting around the arc of dispenser provides extra illumination with a beautiful and appealing effect.



掃描此QR碼了解更多自動製冰器
Scan our QR code to discover more about the automatic ice dispenser



濾水器更換提示功能

設有自動製冰製水器的對門式雪櫃配備濾水器更換提示功能，建議每六個月或當顯示屏上亮起更換提示時更換濾水器。更換濾水器非常簡單方便，顧客可於Siemens Home Appliances Experience Centre或客戶服務中心購買。請聯絡我們以查詢庫存。

Water filter replacement indicator

Side-by-side refrigerator equipped with an ice & water dispenser comes with a water filter replacement indicator. It is recommended to replace in every 6 months or when the "filter change" alert is lighted up on the display panel. Exchanging the water filters is easy and simple, customer can purchase at Siemens Home Appliances Experience Centre or our Customer Contact Center. Please contact us for stock availability.



產品編號 Product Code

00740560

00740572 (濾水器包含在產品內
Filter included in product)

產品名稱 Product Name	UltraClarity® 內置式濾水器 UltraClarity® internal water filter cartridge	內置式粒子過濾型濾水器 Bypass internal water filter cartridge
符合NSF/ANSI 42標準* Certified with NSF/ANSI 42 standards*	符合 Certified	符合 Certified
符合NSF/ANSI 53標準* Certified with NSF/ANSI 53 standards*	符合 Certified	—

* 以上濾水器各獲得美國國家衛生會不同的認證

The above water filters are certified in different levels by Natural Sanitation Foundation

NSF/ANSI 42標準：過濾氯氣、微粒和改善味道及氣味等不影響人體健康的雜質。

NSF/ANSI 42 Standards: Filter non-health-related contaminants, such as chlorine, taste, odour and particulates.

NSF/ANSI 53標準：過濾與人體健康相關的雜質，包括隱孢子蟲、賈第蟲的卵囊和孢囊、鉛、揮發性有機化合物等。

NSF/ANSI 53 Standards: Filters specific-health-related contaminants, such as Cryptosporidium, Giardia, lead and VOCs, etc.

無霜對門雪櫃 No frost refrigerator, side by side

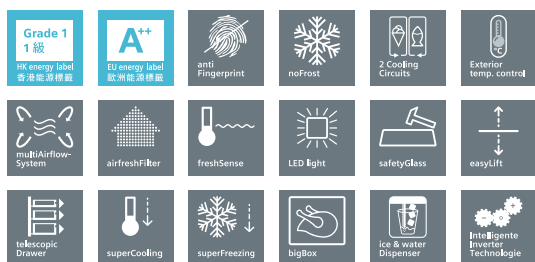

防指紋不銹鋼色櫃門
antiFingerprint stainless steel colour door

KA92DAI30

容量(總/淨 升) Volume (Gross/Net L)	636 / 541
保鮮格容量(淨 升) Fridge volume (Net L)	368
冰格容量(淨 升) Freezer volume (Net L)	173
冷凍功能(每日公斤) Freezing capacity (kg/24hrs)	12
環保雪種 Environmentally friendly refrigerant	R600a
歐洲能源效益標籤 EU energy efficiency	A++
香港能源效益標籤 HK energy label	1
雙製冷系統 Two cooling systems	■
變頻式壓縮機 Inverter compressor	■
櫃外多功能顯示屏 Exterior multi-function display	LCD
LED櫃內照明 LED interior lighting	■
強化玻璃層架(可調高度) Tempered glass shelves (height adjustable)	■
層層出風 multiAirflow	■
特殊功能 Special functions	節能、假日模式、時鐘、計時器 eco, vacation modes, clock, timer
關門提示 Door close reminder	■
控制面板安全鎖 Safety child lock	■
保鮮格(冷藏室) Fridge compartment	
Super冷藏功能 Super cool setting	■
easyLift易升降玻璃層架 easyLift glass shelf	■
空氣過濾網 airFresh filter	■
hyperFresh 0 °C鮮肉保鮮格 (裝有拉趟導軌) hyperFresh 0 °C drawer for fish and meat (with telescopic rail)	■
hyperFresh plus蔬果鎖濕保鮮格 (裝有拉趟導軌) hyperFresh plus drawer with humidity control (with telescopic rail)	■
乳製品儲存格和蛋格 Dairy compartment and egg tray	■
樽架 bottleRack	■
冰格(冷凍室) Freezer compartment	
Super冷凍功能 Super freeze setting	■
特大儲存格 bigBox	■
後備雪種板 Cool pack	2
獨特設計 Features	
自動製冰製水器 Automatic ice and water dispenser	碎冰、冰粒、水 crushed ice, ice cube, water
製冰製水安全鎖 Ice and water dispenser lock	■
內置濾水器 Integrated water filter	■
濾水器更換提示 Water filter replacement indicator	■
製冰製水器出口LED照明 LED illuminated ice and water dispenser	■
尺寸 Dimensions*	
尺寸(厘米) Dimension (cm) (H x W x D)	175.6 x 91.2 x 73.2 (79.8*)
尺寸(吋) Dimension (inch) (H x W x D)	69.1 x 35.9 x 28.8 (31.4*)
原產地 Country of origin	中國 China

* 包括門柄。▲ 深度包括後方25毫米定位作通風。廚櫃內安裝建議預留最少通風位，高：90毫米，兩側：最少25毫米每邊，雪櫃門鉸須設於廚櫃外。

* Include door handle. ▲ Depth includes 25mm spacer at the rear for ventilation. Recommended min. ventilation space for built-in installation, Top: 90mm, Sides: min. 25mm each, door hinge should be placed outside the cabinet.

客戶可享有免費上門評估服務一次，請向銷售人員查詢。Please consult sales consultant for a free on-site inspection.

無霜對門雪櫃 No frost refrigerator, side by side



防指紋不銹鋼色櫃門

antiFingerprint stainless steel colour door

KA92NVI35K

容量(總/淨 升) Volume (Gross/Net L)	659 / 604
保鮮格容量(淨 升) Fridge volume (Net L)	387
冰格容量(淨 升) Freezer volume (Net L)	217
冷凍功能(每日公斤) Freezing capacity (kg/24hrs)	12
環保雪種 Environmentally friendly refrigerant	R600a
歐洲能源效益標籤 EU energy efficiency	A++
香港能源效益標籤 HK energy label	1
雙製冷系統 Two cooling systems	■
變頻式壓縮機 Inverter compressor	■
櫃外LED溫度選擇 Exterior LED temperature selection	■
LED櫃內照明 LED interior lighting	■
強化玻璃層架(可調高度) Tempered glass shelves (height adjustable)	■
層層出風 multiAirflow	■
特殊功能 Special functions	節能、保鮮、假日模式 eco cool, fresh, vacation modes
關門提示 Door close reminder	■
控制面板安全鎖 Safety child lock	■
保鮮格(冷藏室) Fridge compartment	
Super冷藏功能 Super cool setting	■
hyperFresh蔬果鎖濕保鮮格(裝有拉趟導軌) hyperFresh drawer with humidity control (with telescopic rail)	■
乳製品儲存格和蛋格 Dairy compartment and egg tray	■
冰格(冷凍室) Freezer compartment	
Super冷凍功能 Super freeze setting	■
特大儲存格 bigBox	■
旋轉式製冰格 Ice twister	■
尺寸 Dimensions[▲]	
尺寸(厘米) Dimension (cm) (H x W x D)	175.6 x 91.2 x 73.2
尺寸(吋) Dimension (inch) (H x W x D)	69.1 x 35.9 x 28.8
原產地 Country of origin	中國 China

[▲] 深度包括後方25毫米定位作通風。廚櫃內安裝建議預留最少通風位，高：90毫米，兩側：最少25毫米每邊，雪櫃門鉸須設於廚櫃外。

[▲] Depth includes 25mm spacer at the rear for ventilation. Recommended min. ventilation space for built-in installation, Top: 90mm, Sides: min. 25mm each, door hinge should be placed outside the cabinet.

客戶可享有免費上門睇位服務一次，請向銷售人員查詢。Please consult sales consultant for a free on-site inspection.

安裝圖 Installation diagrams

法式多門無霜雪櫃 French door refrigerator

KF86FPB2A

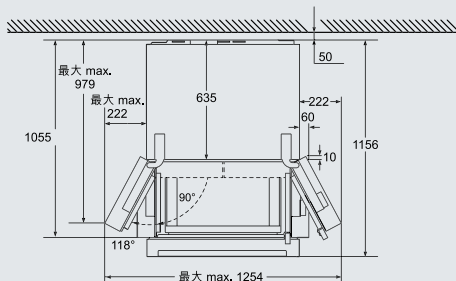
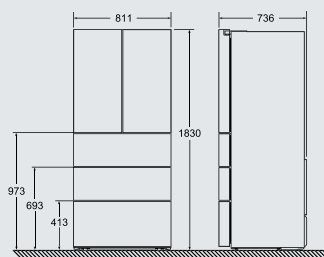

無霜對門雪櫃 No frost refrigerator, side by side

KA92DAI30

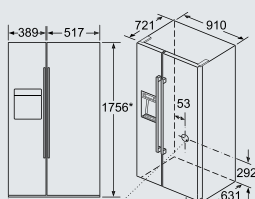

*前腳可調整高度為 1747-1762mm
Front is adjustable from 1747 to 1762

櫃背至門鉸深度
Depth from back to hinge: **631**

櫃背至門板深度
Depth from back to fascia: **721**

櫃背至門柄深度
Depth from back to handle: **787**

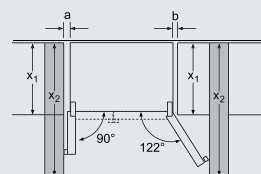
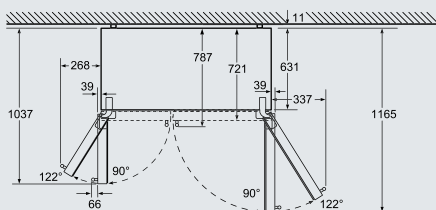

X ₁ (廚櫃深度 unit depth)	a	b
600	39	39
650	39	53
700	39	85
X ₂ (牆壁 wall)	105	337

KA92NVI35K

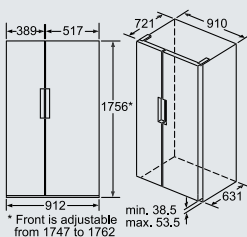

*Front is adjustable from 1747 to 1762

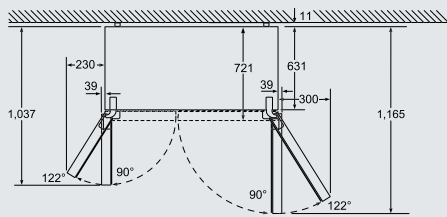

Chilling drawers can be pulled out completely at a door opening angle of 122°

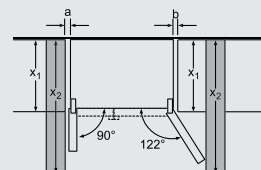

X ₁ (unit depth)	a	b
600	39	39
650	39	53
700	39	85
X ₂ (wall)	39	300

標準廚櫃內安裝尺寸 General built-in installation dimensions

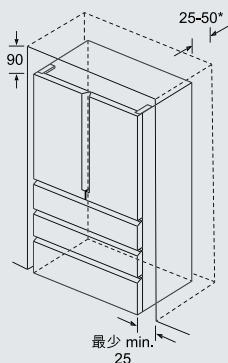

建議預留最少通風位
Recommended min. ventilation space

高 Top: 90

兩側 Each side: 25

背 Back: 25-50*

雪櫃門鉸須設於廚櫃外

Refrigerator door hinge should be placed outside kitchen cabinet

*視乎型號 depends on model

零度無霜3門雪櫃

0°C no frost 3-Door refrigerator



零度保鮮科技 演繹非凡新鮮

西門子無霜零度保鮮雪櫃，將領先的智能科技，充分運用到零度保鮮*上。為食物保鮮提供更全面、更智能的貯存方案，讓您尊享充滿活力的新鮮生活。

hyperFresh 0°C technology for ultimate freshness

Siemens no frost hyperFresh 0°C refrigerator applied the leading intelligent technology for food preservation at 0°C*. It provides more comprehensive and intelligent solution that keeps food at its optimum condition and keeps up with your lifestyle.



冷藏室 盡得便捷自由

冷藏室設計配合人性所需，處處以人為本。易拉出層架，可以水平拉出，方便取放在層架後方物品，充分感受食物擺放的便捷和自由。

Flexible and convenient fridge compartment

Human-centered design focuses on comfort and functionality. The extendable glass shelves can be slid out smoothly, so that you can reach the food at the back of the fridge.



靈活冷凍室 新鮮随心擺放

冷凍室所有抽屜和玻璃層架都能全部移出，根據美食的型狀和大小靈活安排，新鮮由您随心擺放。

Flexible storage in freezer

All drawers and glass shelves in freezer can be removed; flexible arrangements provide enough room to store large frozen items.



* 食材貯存於hyperFresh 0°C保鮮格比正常貯存溫度4°C冷藏室可有效延長食物保鮮期。豬肉、三文魚、草莓和蘆筍貯存於hyperFresh 0°C保鮮格可減少重量損失，維持更好的食物品質。豬肉和三文魚在hyperFresh 0°C保鮮格貯存，沒有檢測到組胺含量產生，顯示微生物污染較少。
SGS 研究報告HKGEC1700510803 (日期：22 Jun 2018)

Food storage in hyperFresh 0°C drawers give a longer life span comparing to normal 4°C compartment storage. Pork, salmon, strawberry and asparagus stored in hyperFresh 0°C drawers receive less weight loss of food; the better quality of food is maintained. Pork and salmon in hyperFresh 0°C drawers, the determination of histamine content is not detected, indicated less microbiological contamination.

- Study report HKGEC1700510803 (dated 22 Jun 2018) issued by SGS Hong Kong Limited



3個獨立製冷系統

絕對的貯存靈活和提高新鮮度，每個區域可單獨調節和保持食物氣味分開。

3 Separate Cooling Systems

Absolute storage flexibility and freshness with 3 temperatures zones, each zone separately regulated and keeps food smell separately.



零度無霜3門雪櫃 0°C no frost 3-Door refrigerator



型格白晶型玻璃門
Cool white glass door

KG28US12EK

容量(總/淨 升) Volume (Gross/Net L)	284 / 275
保鮮格容量(淨 升) Fridge volume (Net L)	197
冷藏室 / hyperFresh 0 °C容量 (淨 升) Freezer volume (Net L)	131 / 66
冰格容量(淨 升) Freezer volume (Net L)	78
冷凍功能(每日公斤) Freezing capacity (kg/24hrs)	10
環保雪種 Environmentally friendly refrigerant	R600a
香港能源效益標籤 HK energy label	1
獨立製冷系統 Separate cooling systems	3
變頻式壓縮機 Inverter compressor	■
櫃外多功能顯示屏 Exterior multi-function display	LCD
特殊功能 Special functions	節能、假日模式、計時器 eco, vacation modes, timer
關門提示 Door close reminder	■
控制面板安全鎖 Safety child lock	■
保鮮格(冷藏室) Fridge compartment	
Super冷藏功能 Super cool setting	■
空氣過濾網 airFresh filter	■
LED櫃內照明 LED Interior lighting	■
強化玻璃層架(可調高度) Tempered glass shelves (height adjustable)	■
hyperFresh 0 °C蔬果保鮮格 (裝有拉趟導軌) hyperFresh 0 °C drawer with humidity filter (with telescopic rail)	■
hyperFresh 0 °C鮮肉保鮮格 (裝有拉趟導軌) hyperFresh 0 °C drawer for fish and meat (with telescopic rail)	■
抽屜式保鮮格(裝有拉趟導軌)和蛋格 Pull out drawer (with telescopic rail) and egg tray	■
乳製品儲存格 Dairy compartment	■
樽架 Bottle holder	■
冰格(冷凍室) Freezer compartment	
Super冷凍功能 Super freeze setting	■
抽屜式冷凍保存格 Pull out drawer	3
旋轉式製冰格 Ice twister	■
尺寸 Dimensions[▲]	
尺寸(厘米) Dimension (cm) (H x W x D)	185.4 x 60 (61.4*) x 66.8
尺寸(吋) Dimension (inch) (H x W x D)	73 x 23.6 (24.2*) x 26.3
原產地 Country of origin	中國 China

左右門鏡選擇 Reversible door hinge

* 包括門板厚度。▲ 深度包括後方定位作通風。廚櫃內安裝建議預留最少通風位，高：90毫米，兩側：最少25毫米每邊，雪櫃門較須設於廚櫃外。

* Include door panel width. ▲ Depth includes spacer at the rear for ventilation. Recommended min. ventilation space for built-in installation, Top: 90mm, Sides: min. 25mm each, door hinge should be placed outside the cabinet.

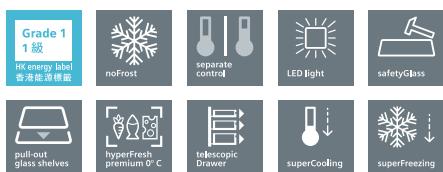

銀色
Silver color

KG28UA290K

容量(總/淨 升) Volume (Gross/Net L)	284 / 275
保鮮格容量(淨 升) Fridge volume (Net L)	197
冷藏室 / hyperFresh 0 °C容量 (淨 升) Freezer volume (Net L)	131 / 66
冰格容量(淨 升) Freezer volume (Net L)	78
冷凍功能(每日公斤) Freezing capacity (kg/24hrs)	10
環保雪種 Environmentally friendly refrigerant	R600a
香港能源效益標籤 HK energy label	1
獨立製冷系統 Separate cooling systems	3
櫃內LED溫度選擇 Interior LED temperature selection	■
關門提示 Door close reminder	■
保鮮格(冷藏室) Fridge compartment	
Super冷凍功能 Super cool setting	■
LED櫃內照明 LED Interior lighting	■
強化玻璃層架(可調高度) Tempered glass shelves (height adjustable)	■
hyperFresh 0 °C蔬果保鮮格 (裝有拉趟導軌) hyperFresh 0 °C drawer for fruits and vegetables (with telescopic rail)	■
hyperFresh 0 °C鮮肉保鮮格 (裝有拉趟導軌) hyperFresh 0 °C drawer for fish and meat (with telescopic rail)	■
抽屜式保鮮格和蛋格 Pull out drawer and egg tray	■
冰格(冷凍室) Freezer compartment	
Super冷凍功能 Super freeze setting	■
抽屜式冷凍保存格 Pull out drawer	3
冰粒格 Ice cube tray	■
尺寸 Dimensions[▲]	
尺寸(厘米) Dimension (cm) (H x W x D)	185.4 x 60 (61.2*) x 66.2
尺寸(吋) Dimension (inch) (H x W x D)	73 x 23.6 (24*) x 26
原產地 Country of origin	中國 China

左右門鉸選擇 Reversible door hinge

* 包括門板厚度。 ▲ 深度包括後方定位作通風。廚櫃內安裝建議預留最少通風位，高：90毫米，兩側：最少25毫米每邊，雪櫃門鉸須設於廚櫃外。

* Include door panel width. ▲ Depth includes spacer at the rear for ventilation. Recommended min. ventilation space for built-in installation, Top: 90mm, Sides: min. 25mm each, door hinge should be placed outside the cabinet.

貼心設計 方便節能

Efficient and user-friendly design



層層出風

雪櫃背壁有多層出風口，以層層出風的方法讓冷空氣吹遍櫃內每一角落，從而帶出均勻的冷藏效果，空氣循環比一般出風方法更有效率。無論食物放進任何層格都能受冷風吹拂，冷藏自然更快。即使櫃內滿載食物仍能保持穩定溫度，食物保鮮期自然更長久。

multiAirflow

multiAirflow ensures balanced distribution of cold air throughout the refrigerator by using multi-level air vents sited in rear panels. Efficiency is improved in comparison to normal air-out techniques. As such, food can be chilled faster wherever it is placed, even if the refrigerator is fully loaded, a constant temperature is retained to preserve food freshness.



空氣過濾網

內置活性炭過濾網的蜂巢式表面能有效過濾櫃內空氣。當放入氣味濃烈的食物時，過濾網便會發揮作用，吸走難聞氣味，讓雪櫃時刻保持清新亦避免影響其他食物的味道。

airFresh filter

Strong smelling foods can be stored without any worries. The efficient integrated carbon filtering net with special honeycomb surface absorbs all pungent smell and secures the flavour of each item.



掃描此QR碼
了解更多空氣過濾網

Scan our QR code to discover
more about airFresh filter

LED電子溫度控制

帶LED光的輕觸式控制鍵及溫度顯示，操控簡單清晰，讓您輕鬆使用雪櫃的每個功能。

LED electronic temperature control

The sophisticated LED-illuminated touch panel and temperature indication give you easy control of the refrigerator functions.



櫃內控制 Interior control

Super冷藏 / 冷凍功能

當儲存大量新鮮食物時，可按Super鍵，保鮮格/冰格內的溫度即迅速急降，為新鮮食物急速降溫，亦避免室溫食物影響保鮮格或冰格已存食物的溫度。

Super cool and Super freeze setting

To store large quantities of new fresh food, a press of the Super button will rapidly lower the temperature of either fridge or freezer compartments. This quickly cools new contents to retain their freshness and avoids consequent increase in temperature of existing contents that would shorten their lifespan.



樽架

寬闊的金屬樽架可因應需要裝上或移走，使櫃內空間更加靈活實用。

bottleRack

The full-width metal bottleRack can be flexibly removed to allow efficient use of space.



無霜雪櫃 (下置冰格) No frost refrigerator, bottom freezer



防指紋不銹鋼色櫃門
antiFingerprint stainless steel colour door

KG36NVI35K

容量(總/淨 升) Volume (Gross/Net L)	357 / 324
保鮮格容量(淨 升) Fridge volume (Net L)	237
冰格容量(淨 升) Freezer volume (Net L)	87
冷凍功能(每日公斤) Freezing capacity (kg/24hrs)	14
環保雪種 Environmentally friendly refrigerant	R600a
歐洲能源效益標籤 EU energy efficiency	A++
香港能源效益標籤 HK energy label	1
雙製冷系統 Two cooling systems	■
櫃內LED溫度選擇 Interior LED temperature selection	■
eco節能模式 eco energy saving mode	■
關門提示 Door close reminder	■
保鮮格(冷藏室) Fridge compartment	
Super冷藏功能 Super cool setting	■
層層出風 multiAirflow	■
空氣過濾網 airFresh filter	■
LED櫃內照明 LED Interior lighting	■
強化玻璃層架(可調高度) Tempered glass shelves (height adjustable)	■
hyperFresh蔬果鎖濕保鮮格 hyperFresh drawer with humidity control	■
hyperFresh 0 °C 鮮肉保鮮格 hyperFresh 0 °C drawer for fish and meat	2
樽架和蛋格 bottleRack and egg tray	■
冰格(冷凍室) Freezer compartment	
Super冷凍功能 Super freeze setting	■
抽屜式冷藏保存格 Pull out drawer	3
有蓋冰粒格 Ice cube tray with lid	■
尺寸 Dimensions[▲]	
尺寸(厘米) (高x闊x深) Dimension (cm) (H x W x D)	186 x 60 x 66
尺寸(吋) (高x闊x深) Dimension (inch) (H x W x D)	73.2 x 23.6 x 26
原產地 Country of origin	土耳其 Turkey

左右門鉸選擇 Reversible door hinge

[▲] 深度包括後方定位作通風。廚櫃內安裝建議預留最少通風位，高：90毫米，兩側：最少25毫米每邊。

[▲] Depth includes spacer at the rear for ventilation. Recommended min. ventilation space for built-in installation, Top: 90mm, Sides: min. 25mm each.

無霜雪櫃 (下置冰格) No frost refrigerator, bottom freezer



鈦銀面
Inox look fascia

KG36NNL30K

KG33NNL30K

容量(總/淨 升) Volume (Gross/Net L)	329 / 302	306 / 279
保鮮格容量(淨 升) Fridge volume (Net L)	215	192
冰格容量(淨 升) Freezer volume (Net L)	87	87
冷凍功能(每日公斤) Freezing capacity (kg/24hrs)	11	11
環保雪種 Environmentally friendly refrigerant	R600a	R600a
歐洲能源效益標籤 EU energy efficiency	A++	A++
香港能源效益標籤 HK energy label	1	1
關門提示 Door close reminder	■	■
保鮮格(冷藏室) Fridge compartment		
櫃內溫度選擇 Interior temperature selection	■	■
LED櫃內照明 LED Interior lighting	■	■
強化玻璃層架(可調高度) Tempered glass shelves (height adjustable)	■	■
Fresh蔬果保鮮格 Fresh fruits and vegetables drawer	■	■
蛋格 Egg tray	■	■
冰格(冷凍室) Freezer compartment		
LED溫度選擇 LED temperature selection	■	■
Super冷凍功能 Super freeze setting	■	■
easyAccess冷凍保存格 easyAccess drawer	1	1
抽屜式冷藏保存格 Pull out drawer	2	2
尺寸 Dimensions[▲]		
尺寸(厘米) (高x闊x深) Dimension (cm) (H x W x D)	186 x 60 x 66	176 x 60 x 66
尺寸(吋) (高x闊x深) Dimension (inch) (H x W x D)	73.2 x 23.6 x 26	69.3 x 23.6 x 26
原產地 Country of origin	土耳其 Turkey	土耳其 Turkey

左右門鉸選擇 Reversible door hinge

▲ 深度包括後方定位作通風。廚櫃內安裝建議預留最少通風位，高：90毫米，兩側：最少25毫米每邊。

▲ Depth includes spacer at the rear for ventilation. Recommended min. ventilation space for built-in installation, Top: 90mm, Sides: min. 25mm each.

無霜雪櫃 (上置冰格) No frost refrigerator, top freezer



* 視乎型號 Depends on model

鈦銀面 Inox look fascia	KD28NVL3AK	KD25NVL3AK	KD23NVL3AK
容量(總/淨 升) Volume (Gross/Net L)	272 / 245	250 / 224	230 / 202
保鮮格容量(淨 升) Fridge volume (Net L)	195	174	152
冰格容量(淨 升) Freezer volume (Net L)	50	50	50
冷凍功能(每日公斤) Freezing capacity (kg/24hrs)	3	3	3
環保雪種 Environmentally friendly refrigerant	R600a	R600a	R600a
香港能源效益標籤 HK energy label	1	1	1
變頻式壓縮機 Inverter compressor	■	■	■
保鮮格(冷藏室) Fridge compartment			
層層出風 multiAirflow	■	■	■
空氣過濾網 airFresh filter	■	■	■
櫃內溫度控制 Interior temperature control	■	■	■
LED櫃內照明 LED Interior lighting	■	■	■
Fresh zone保鮮格和蛋格 Fresh zone compartment and egg tray	■	■	■
強化玻璃層架(可調高度) Tempered glass shelves (height adjustable)	■	■	■
hyperFresh蔬果鎖濕保鮮格 hyperFresh drawer with humidity control	■	■	■
門架設計 Door rack design *	5	4	3
冰格(冷凍室) Freezer compartment			
櫃內溫度控制 Interior temperature control	■	■	■
強化玻璃層架 Tempered glass shelves	■	■	■
旋轉式製冰格 Ice twister	■	■	■
尺寸 Dimensions*			
尺寸(厘米) (高x闊x深) Dimension (cm) (H x W x D)	165.6 x 55 x 60.5	155.6 x 55 x 60.5	145.6 x 55 x 60.5
尺寸(吋) (高x闊x深) Dimension (inch) (H x W x D)	65.2 x 21.7 x 23.8	61.3 x 21.7 x 23.8	57.3 x 21.7 x 23.8
原產地 Country of origin	中國 China	中國 China	中國 China

左右門鉸選擇 Reversible door hinge

* 廚櫃內安裝建議預留最少通風位，高：90毫米，兩側：最少25毫米每邊，背：50毫米，雪櫃門鉸須設於廚櫃外。

* Recommended min. ventilation space for built-in installation, Top: 90mm, Sides: min. 25mm each, Back: 50mm, door hinge should be placed outside the cabinet.

安裝圖 Installation diagrams

零度無霜3門雪櫃 0°C no frost 3-Door refrigerator

KG28US12EK

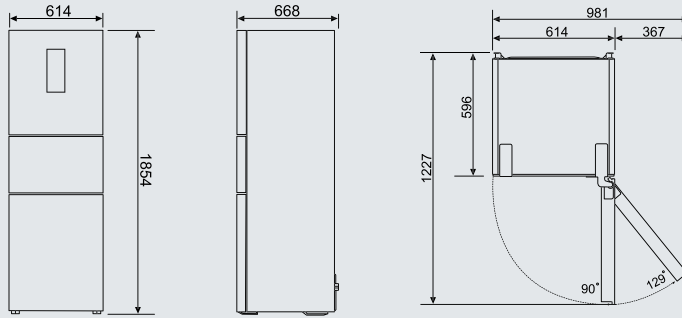

KG28UA290K

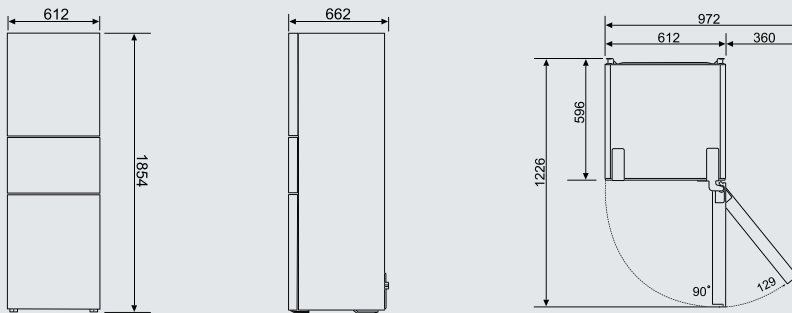

無霜雪櫃 (下置冰格) No frost refrigerator, bottom freezer

KG36NVI35K / KG36NNL30K / KG33NNL30K

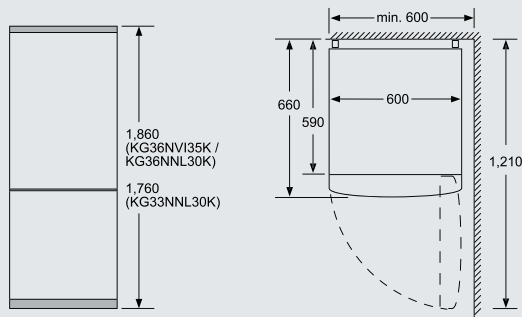

無霜雪櫃 (上置冰格) No frost refrigerator, top freezer

KD28NVL3AK / KD25NVL3AK / KD23NVL3AK

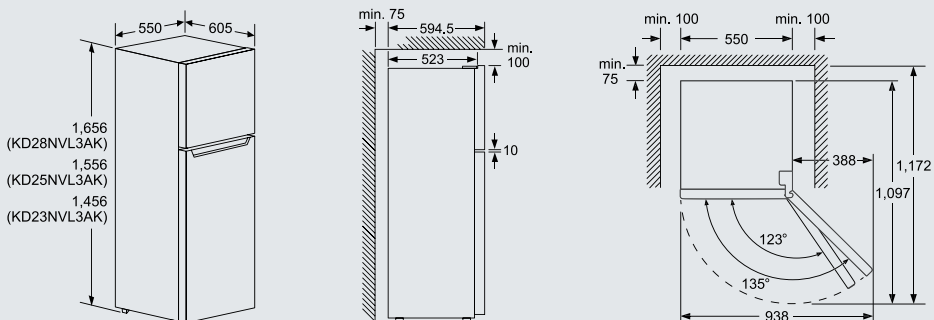

如科技發展般卓越：體驗專業清潔配方

As smart as the technology: The recipe for intelligent cleaning.



雪櫃清潔劑

Special Cleaner for Refrigerators

產品編號 Product Code: 00311889

食品安全清潔劑

此清潔劑乃生態友善配方，符合食品安全，專為存放各種新鮮或已烹調食物的雪櫃而設。德國製造，清潔劑經原廠測試及檢定，確保您安心使用。

Food safe cleaner

Thanks to the food safe and eco-friendly formulae, the special cleaner is developed for storing a variety of fresh or cooked delicacies refrigerators and freezers. Made in Germany, the cleaner is tested and approved for your Siemens refrigerators, ensuring peace of mind.

強效清潔 還原清新

佳餚放進雪櫃後，容易留下醬汁與氣味。呈泡沫狀的清潔劑能助您有效移除污垢，亦為您帶走異味，令雪櫃還原清新。

Hygienically clean and fresh

Dips, grease residues and smell from the food may end up in the fridge. The foam of cleaner specializes in dirt removal; reduces odours and gives a pleasant smell at once.

裡外全效清潔

不論是塑膠、金屬、玻璃或塗層表面，您亦可以使用此清潔劑為雪櫃內及外層所有表面進行清潔。

Single product on all surfaces

With only this cleaner, you can easily remove all residues in and outside of refrigerators on all surfaces made of plastic, metal, glass, as well as printed or coated surfaces.



不銹鋼護理抹布

Conditioning Cloths for Stainless Steel Surfaces

產品編號 Product Code: 00311944

擁有二合一功用的不銹鋼護理抹布可清除污漬、手指模印及同時為不銹鋼表面塗上保護層，令家電表面亮麗如初。

The 2-in-1 conditioning cloths can clean the stainless steel surfaces, protect it from fingerprints and further marks, which leave attractive shiny finish and enhance the look of your appliances.

以上產品可於Siemens Home Appliance Experience Centre或客戶服務中心訂購。請聯絡我們以查詢庫存。
Above items can be purchased at Siemens Home Appliance Experience Centre and our Customer Contact Center.
Please contact us for stock availability.



雪櫃節能小智慧

Tips for refrigerator

1. Refrigerator should be placed away from heat sources such as a cooker, and make sure it is not in direct sunlight. It will operate more efficiently if it is in a cool spot.

雪櫃應盡量遠離熱源，如爐具，並確保安裝在不受陽光照射的位置。雪櫃在陰涼環境下會更有效地運作。

2. Keep the refrigerator at least 2.5cm of space on each side to allow good air circulation, and ensure there is adequate ventilation space at the back and top of the refrigerator.

保持雪櫃兩邊與其他物件至少距離2.5cm，以提供良好的空氣流通。並確保雪櫃的背面和頂部有足夠的空間通風。

3. Refrigerator should be kept at a steady temperature. Recommended temperatures are 2 – 4 °C for the fresh food compartment and -18 °C for a freezer.

雪櫃應保持在穩定溫度下操作。建議冷藏室溫度約在2 – 4 °C，冷凍室設定在-18 °C。

4. Do not put hot food straight into the refrigerator. As this will use up more energy when the fridge attempts to cool the food down. Save energy by letting it cool down first.

不要把熱的食物直接放入雪櫃。這會令雪櫃因需要冷卻熱的食物而增加能源消耗。建議先將食物涼放一會才放入雪櫃，以節省能源。

5. When you open the refrigerator door, the cool air escapes. The unit then works harder to replace the air. Therefore, minimize door openings as much as possible.

當每次打開雪櫃門，雪櫃內的冷空氣都會散失。然後雪櫃需要更多能源進行制冷。因此，請盡可能減少開門次數。

6. Cover liquids and containers with plastic wrap or a top so the fridge does not have to chill every exposed surface.

先將液體和容器用保鮮膜或頂蓋蓋好，再存放在雪櫃，以減少直接冷卻表面，浪費能源。

7. Make sure the refrigerator doors are properly shut and that the seals are clean.

確保雪櫃門正常關閉，密封封條保持乾淨。

尚有一系列西門子家電
就讓我們為您一一展現
Siemens Home Appliances
offers a wide selection of
the latest appliances



型號及規格只供參考，如有改動恕不另行通知。

Model numbers and specifications are for reference only and subject to change without prior notice.

博西華家用電器有限公司保留更改以上產品功能資料之權利。

產品實物之顏色可能與相片有輕微差異。

Right of technical modification reserved, delivery subject to availability, colors of actual products may vary from illustrations.

®註冊商標

® Registered trademark.

©2019博西華家用電器有限公司。所有權利保留。本目錄冊所載的全部內容及資料均屬博西華家用電器有限公司所有，且受版權保護。

任何人士如未獲博西華家用電器有限公司事先給予書面許可，不得複製、轉載、發放或擅用本目錄冊的任何內容或資料。印刷版本：03.2019

©2019 BSH Home Appliances Limited. All rights reserved. All contents and information contained in this catalogue are proprietary to

BSH Home Appliances Limited and are subject to copyright protection. Reproduction, republication, redistribution or unauthorised use of any

content or information contained in this catalogue is expressly prohibited without the prior written consent of BSH Home Appliances Limited. Print edition: 03.2019

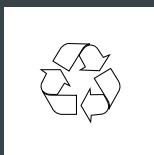

掃描QR碼
瀏覽網上
產品手冊



Scan
QR code
to browse
brochure
online



博西華家用電器有限公司

BSH集團是西門子股份公司的特許商標持有人

BSH Home Appliances Limited

BSH Group is a Trademark Licensee of Siemens AG

Siemens Home Appliances Experience Centre

中環雪廠街16號西洋會所大廈5樓 (入口位於都爹利街)

5/F, Club Lusitano, 16 Ice House Street, Central, Hong Kong (main entrance on Duddell Street)

客戶服務專線 Customer Contact Hotline:

2565 6151 (香港 Hong Kong) / 0800 030 (澳門本地專用 Macau local call only)

電郵 E-mail: siemens.hk.showroom@bshg.com

www.siemens-home.bsh-group.com.hk



facebook.com/SiemensHomeHongKong