



**BOSCH**

**Register** your  
appliance and join  
the Bosch  
family of perks:  
[bosch-home.com/us/  
mybosch](https://bosch-home.com/us/mybosch)



# Washing machine

**WGB246AXUC**

**[en-us]** User manual and installation  
instructions

Further information and explanations are available online:



## Table of contents

<b>1 Safety</b> .....	<b>4</b>	13.4 Opening the door .....	26
1.1 Safety definitions.....	4	13.5 Loading laundry.....	26
1.2 General information.....	4	13.6 Starting the program.....	26
1.3 Intended use .....	4	13.7 Soaking laundry .....	27
1.4 Restrictive Use.....	4	13.8 Adding laundry .....	27
1.5 Grounding instructions .....	4	13.9 Terminating the program .....	27
1.6 Safe installation.....	5	13.10 Removing the laundry .....	27
1.7 Safe use.....	5	13.11 Put the appliance into standby mode.....	27
1.8 Safe cleaning and maintenance .....	6	<b>14 Control panel lock</b> .....	<b>27</b>
1.9 State of California Proposition 65 Warnings .....	7	14.1 Activating the control panel lock .....	27
<b>2 Preventing material damage</b> .....	<b>8</b>	14.2 Deactivating the control panel lock.....	27
<b>3 Environmental protection and energy-saving</b> .....	<b>8</b>	<b>15 Intelligent dosing system</b> .....	<b>27</b>
3.1 Disposal of packaging .....	8	15.1 Pouring liquid detergent and fabric softener into the dispensers.....	28
3.2 Save energy and conserve resources .....	8	15.2 Using the manual dosing compartment .....	28
3.3 Energy-saving mode .....	8	15.3 Adapting the  dispenser.....	28
<b>4 Installation and connection</b> .....	<b>9</b>	15.4 Setting the basic dosage amount .....	28
4.1 Unpacking the appliance .....	9	<b>16 Home Connect®</b> .....	<b>28</b>
4.2 Included in delivery .....	9	16.1 Setting up the Home Connect® app .....	29
4.3 Requirements for the installation location.....	9	16.2 Setting up Home Connect®.....	29
4.4 Installation types .....	10	16.3 Activating Wi-Fi on the appliance .....	29
4.5 Removing the transit bolts.....	11	16.4 Deactivating Wi-Fi on the appliance .....	29
4.6 Connecting the appliance.....	12	16.5 Installing a software update.....	29
4.7 Aligning the appliance .....	13	16.6 Resetting the appliance network settings .....	29
<b>5 Before using for the first time</b> .....	<b>14</b>	16.7 Remote start.....	29
5.1 Starting an empty washing cycle.....	14	16.8 Remote diagnostics.....	29
<b>6 Familiarizing yourself with your appliance</b> .....	<b>15</b>	16.9 Data Protection .....	29
6.1 Appliance .....	15	<b>17 Basic settings</b> .....	<b>30</b>
6.2 Detergent drawer .....	15	17.1 Overview of the basic settings.....	30
6.3 Control panel.....	16	17.2 Changing the basic settings .....	30
6.4 Operating logic.....	16	<b>18 Cleaning and maintenance</b> .....	<b>30</b>
<b>7 Display</b> .....	<b>18</b>	18.1 Cleaning the drum .....	30
<b>8 Buttons</b> .....	<b>20</b>	18.2 Cleaning the detergent drawer .....	30
<b>9 Programs</b> .....	<b>22</b>	18.3 Cleaning the drain pump .....	32
<b>10 Accessories</b> .....	<b>25</b>	18.4 Cleaning the inlet opening in the rubber gasket.....	35
<b>11 Laundry</b> .....	<b>25</b>	<b>19 Troubleshooting</b> .....	<b>36</b>
11.1 Preparing the laundry .....	25	19.1 Emergency release .....	39
<b>12 Detergents and care products</b> .....	<b>25</b>	<b>20 Transportation, storage and disposal</b> .....	<b>40</b>
<b>13 Basic Operation</b> .....	<b>25</b>	20.1 Removing the appliance .....	40
13.1 Switching on the appliance.....	25	20.2 Inserting the transit bolts .....	40
13.2 Setting a program .....	25	20.3 Using the appliance again .....	40
13.3 Saving the program settings.....	26	20.4 Disposal of your old appliance.....	40

<b>21 Customer Service .....</b>	<b>40</b>
21.1 Model number (E-Nr.), production number (FD) and consecutive numbering (Z-Nr.) .....	40
<b>22 Technical specifications.....</b>	<b>41</b>
22.1 Information regarding Free and Open Source Software.....	41



# IMPORTANT SAFETY INSTRUCTIONS

## READ AND SAVE THESE INSTRUCTIONS

---

Read all of the instructions carefully before using the appliance. In order to reduce the risk of fire, electric shocks and personal injuries when using the appliance, follow the basic safety precautions, including the following safety instructions.

### 1.1 Safety definitions

Here you can find explanations of the safety signal words used in this manual.

### 1.2 General information



- Read this manual carefully.
- Keep the manual and the product information in a safe place for future reference or for the next owner.
- Do not connect the appliance if it has been damaged in transit.

### 1.3 Intended use

Only a licensed professional may connect appliances without plugs. The manufacturer is not responsible for damage caused by incorrect connections. An incorrect connection is not covered by the Statement of Limited Product Warranty.

Only use this appliance:

- For washing machine-washable fabrics and hand-washable wool in accordance with the care label.
- With tap water and commercially available, washing-machine-suitable detergents and care products.
- for normal household use and in enclosed spaces in a residential environment.
- Up to an altitude of 13,100 ft (4000 m) above sea level.

### 1.4 Restrictive Use

This appliance is not intended for use by persons (including children) with reduced physical, sensory or mental capabilities, or lack of experience and knowledge,

#### **WARNING**

This indicates that death or serious injuries may occur as a result of non-observance of this warning.

#### **CAUTION**

This indicates that minor or moderate injuries may occur as a result of non-observance of this warning.

#### **NOTICE:**

This indicates that damage to the appliance or property may occur as a result of non-compliance with this advisory.

**Note:** This alerts you to important information and/or tips.

unless they have been given supervision or instruction concerning use of the appliance by a person responsible for their safety.

Do not let children play with the appliance.

Cleaning and user maintenance must not be performed by children unless they are being supervised.

Keep children under the age of 3 and pets away from the appliance.

### 1.5 Grounding instructions

This appliance must be grounded. In the event of malfunction or breakdown, grounding will reduce the risk of electric shock by providing a path of least resistance for electric current. This appliance is equipped with a cord having an equipment-grounding conductor. Installation, electrical connections and grounding must comply with all applicable codes.

#### **WARNING**

Improper connection of the equipment-grounding conductor can result in a risk of electric shock.

- ▶ Check with a qualified electrician or authorized service representative if you are in doubt whether the appliance is properly grounded.



# IMPORTANT SAFETY INSTRUCTIONS

## READ AND SAVE THESE INSTRUCTIONS

### 1.6 Safe installation

#### WARNING

Incorrect installation is dangerous.

- ▶ Connect and operate the appliance only in accordance with the specifications on the rating plate.
- ▶ Connect the appliance to a power supply with alternating current only via a correctly installed socket outlet with grounding.
- ▶ The protective conductor system of the domestic electrical installation must be properly installed. The installation must have a sufficiently large cable cross-section.
- ▶ When using a residual current circuit breaker, only use a type with the  mark.
- ▶ Never equip the appliance with an external switching device, e.g. a timer or remote control.
- ▶ When the appliance is installed, the power plug of the power cord must be freely accessible. If free access is not possible, an all-pole isolating switch must be integrated in the permanent electrical installation according to the installation regulations.

- ▶ When installing the appliance, check that the power cord is not trapped or damaged.

If the insulation of the power cord is damaged, that can be dangerous.

- ▶ Never let the power cord come into contact with hot appliance parts or heat sources.
- ▶ Never let the power cord come into contact with sharp points or edges.
- ▶ Never kink, crush or modify the power cord.

#### WARNING

It is dangerous to use an extended power cord and non-approved adapters.

- ▶ Do not use extension cords or multiple socket strips.
- ▶ Only use adapters and power cords approved by the manufacturer.
- ▶ If the power cord is too short and a longer one is not available, please contact an electrician to have the domestic installation adapted.

#### WARNING

The heavy weight of the appliance may result in injury when lifted.

- ▶ Do not lift the appliance on your own.

If this appliance is not correctly installed in a washer-dryer stack, the installed appliance may fall.

- ▶ Only stack the dryer on a washing machine using the connection kit from the dryer manufacturer. No other installation method is permitted.
- ▶ Do not install the appliance in a washer-dryer stack if the dryer manufacturer does not offer a suitable connection kit.
- ▶ Do not install appliances from different manufacturers and with varying depths and widths in a washer-dryer stack.
- ▶ Do not install a washer-dryer stack on a platform; the appliances may tip over.

#### WARNING

Children may pull packaging material over their heads, or wrap themselves up in it and suffocate.

- ▶ Keep packaging material away from children.
- ▶ Do not allow children to play with packaging material.

#### CAUTION

The appliance may vibrate or move when in use.

- ▶ Place the appliance on a clean, even, solid surface.
- ▶ Align the appliance using the appliance feet and a spirit level.

If hoses and power cords have been laid incorrectly, this causes a tripping hazard.

- ▶ Lay hoses and power cords in such a way that there is no risk of tripping.

If the appliance is moved by holding onto protruding components, such as the appliance door, the parts may break off.

- ▶ Do not move the appliance by holding onto protruding parts.

#### CAUTION

Touching sharp edges on the appliance may lead to cuts.

- ▶ Do not touch the sharp edges on the appliance.
- ▶ Wear protective gloves when installing and transporting the appliance.

### 1.7 Safe use

#### WARNING

If the appliance or the power cord is damaged, this is dangerous.

- ▶ Never operate a damaged appliance.
- ▶ Never pull on the power cord to unplug the appliance. Always unplug the appliance at the power outlet.



# IMPORTANT SAFETY INSTRUCTIONS

## READ AND SAVE THESE INSTRUCTIONS

---

- ▶ If the appliance or the power cord is damaged, immediately unplug the power cord or switch off the breaker in the circuit breaker box and turn off the water tap.

▶ Call Customer Service. → *Page 40*

Moisture intrusion may cause an electric shock.

- ▶ Use the appliance in enclosed spaces only.
- ▶ Never expose the appliance to intense heat or humidity.
- ▶ Do not use steam cleaners, high-pressure cleaners, hoses or sprays to clean the appliance.

### WARNING

Children can lock themselves in the appliance, thereby putting their lives at risk.

- ▶ Do not install the appliance behind a door as this may obstruct the appliance door or prevent it from opening.
- ▶ With redundant appliances, pull out the mains plug of the power cord, cut through the power cord and remove the appliance door.

When spinning larger, waterproof items of laundry, imbalances may arise and lead to injuries.

- ▶ Do not wash and spin larger items of laundry, such as blankets or mattress covers, in the appliance.

### WARNING

Children may breathe in or swallow small parts, causing them to suffocate.

- ▶ Keep small parts away from children.
- ▶ Do not allow children to play with small parts.

### WARNING

A hot-water system that has not been used for 2 weeks or more may produce flammable hydrogen gas.

- ▶ Before using the appliance open all hot-water faucets for a few minutes to release hydrogen gas.
- ▶ During these minutes, do not smoke or use an open flame.

### WARNING

Detergents and care products may result in poisoning if consumed.

- ▶ If accidentally swallowed, seek medical advice.
- ▶ Keep detergents and care products out of the reach of children.

### WARNING

Laundry that has been pretreated with flammable cleaning agents that contain solvents may cause an explosion in the appliance.

- ▶ Rinse pretreated laundry thoroughly with water before washing.

### CAUTION

The covering plate may break if you stand on or climb onto the appliance.

- ▶ Do not stand on or climb onto the appliance.
- The appliance may tip over if you sit on or lean against the open door.
- ▶ Do not sit on or lean against the appliance door.
  - ▶ Do not place any objects on the appliance door.
- Reaching into the drum while it is still turning may cause hand injuries.
- ▶ Wait for the drum to come to a complete stop before reaching inside.

### CAUTION

When you wash at high temperatures, the detergent solution becomes hot.

- ▶ Do not touch the hot detergent solution.

### CAUTION

If the detergent drawer is opened, detergent and care products may spray out from the appliance. Contact with eyes or skin may cause irritation.

- ▶ Rinse eyes and/or skin thoroughly with clean water if they come into contact with detergents or care products.
- ▶ If accidentally swallowed, seek medical advice.
- ▶ Keep detergents and care products out of the reach of children.

## 1.8 Safe cleaning and maintenance

### WARNING

Improper repairs are dangerous.

- ▶ Never make any technical modifications to the appliance or its features.
- ▶ Do not tamper with controls.
- ▶ Repairs to the appliance should only be performed by authorized service providers.
- ▶ Only original spare parts may be used to repair the appliance.



# IMPORTANT SAFETY INSTRUCTIONS

## READ AND SAVE THESE INSTRUCTIONS

---

- ▶ If the power cord of this appliance becomes damaged, it must be replaced by the manufacturer, the manufacturer's Customer Service, or an authorized service provider in order to prevent injury.

Moisture intrusion may cause an electric shock.

- ▶ Before cleaning, pull out the power plug or switch off the circuit breaker in the circuit breaker box.
- ▶ Do not use steam cleaners, high-pressure cleaners, hoses or sprays to clean the appliance.

### WARNING

The use of non-original spare parts and non-original accessories is dangerous.

- ▶ Only use the manufacturer's original spare parts and original accessories.

### WARNING

Poisonous fumes may be given off if you use cleaning agents that contain solvents.

- ▶ Do not use cleaning agents that contain solvents.

## 1.9 State of California Proposition 65 Warnings

This product may contain a chemical known to the State of California, which can cause cancer or reproductive harm. Therefore, the packaging of your product may bear the following label as required by California:

**STATE OF CALIFORNIA PROPOSITION 65 WARNING:**



**WARNING**

Cancer and Reproductive Harm - [www.P65Warnings.ca.gov](http://www.P65Warnings.ca.gov)

## 2 Preventing material damage

### NOTICE:

The functionality of the appliance may be impaired if you use the wrong quantity of fabric softener, detergent, care product or cleaning agent.

- ▶ Follow the dosage recommendations from the manufacturer.
- ▶ Only use fabric softeners or products to eliminate static that are specifically recommended for this purpose by the product manufacturer.

Exceeding the maximum load capacity impairs the function of the appliance.

- ▶ Observe the maximum load capacity for each programme and do not exceed it.

→ "Programs", Page 22

The appliance is secured for transportation using transport locks. Transit bolts which have not been removed may result in material damage and damage to the appliance.

- ▶ Before starting up the appliance, remove the transit bolts completely and keep them in a safe place.
- ▶ Before transport, fit the transit bolts fully in order to prevent damage in transit.

Material damage may be caused if the water inlet hose is connected incorrectly.

- ▶ Tighten the screw connections on the water inlet until they are hand-tight.
- ▶ Connect the water inlet hose directly to the water tap, without any additional connecting elements such as adapters, extensions, or valves.
- ▶ Make sure that the valve housing for the water inlet hose does not come into contact with its surroundings and is not subjected to any external forces.
- ▶ Ensure that the inner diameter of the water tap is at least 17 mm.
- ▶ Make sure that the length of the thread on the connection to the water tap is at least 10 mm.

If the water pressure is too high or too low, this may impair functioning of the appliance.

- ▶ Make sure that the water pressure in the water supply system is at least 14.5 psi (100 kPa) and max. 145 psi (1000 kPa).
- ▶ If the water pressure exceeds the maximum value specified, a pressure-reducing valve must be installed between the drinking water connection and the hose set of the appliance.
- ▶ Do not connect the appliance to the mixer tap of an unpressurised hot-water boiler.

Modified or damaged water hoses may result in material damage and damage to the appliance.

- ▶ Never kink, crush, modify or cut through water hoses.
- ▶ Only use the water hoses supplied with the appliance or genuine spare hoses.
- ▶ Never re-use water hoses that have been used before.

Operating the appliance using water that is dirty or too hot may lead to material damage and damage to the appliance.

- ▶ Only operate the appliance with cold or warm (max. 60 °C/140 °F) mains water.

Unsuitable cleaning agents may damage the surfaces of the appliance.

- ▶ Do not use strong or abrasive cleaning agents.
- ▶ Do not use cleaning agents with a high alcohol content.
- ▶ Do not use hard scouring pads or cleaning sponges.
- ▶ Clean the appliance with nothing but water and a soft, damp cloth.
- ▶ Remove all detergent residue, spray residue or other residues immediately if they come into contact with the appliance.

## 3 Environmental protection and energy-saving

### 3.1 Disposal of packaging

The packaging materials are environmentally compatible and can be recycled.

- ▶ Sort the individual components by type and dispose of them separately.

### 3.2 Save energy and conserve resources

If you follow these instructions, your appliance will use less power and water.

- Choose programs with low temperatures and longer wash times and use maximum load capacity.  
→ Page 22
- Add detergent based on the laundry's degree of soiling.
- Reduce the washing temperature for lightly and normally soiled laundry.
- Set the maximum spin speed if you want to dry the laundry in a tumble dryer afterwards.
- Wash the laundry without prewash.

### 3.3 Energy-saving mode

If you do not use the appliance for a brief period, it automatically switches to energy-saving mode. All displays go out and II ▷ flashes.

Energy-saving mode ends when you use the appliance again.

If you do not use the appliance for an extended period, it automatically switches to standby mode.



## 4 Installation and connection

Install the appliance according to the manufacturer's instructions and local codes.

### 4.1 Unpacking the appliance

#### NOTICE:

Objects remaining in the drum that are not designed for operation with the appliance may cause material damage and damage to the appliance.

- ▶ Remove these objects, along with all supplied accessories, from the drum before starting the appliance.

1. Remove any packaging and protective covers completely from the appliance.

→ "Disposal of packaging", Page 8

2. Check the appliance for visible damage.
3. Open the door. → Page 26
4. Remove any accessories from the drum.
5. Close the door.

### 4.2 Included in delivery

After unpacking all the parts, check for any damage in transit and for completeness of delivery.

#### NOTICE:

If the appliance is operated with incomplete or defective accessories, the appliance may not be able to operate properly, or this may result in material damage and damage to the appliance.

- ▶ Do not operate the appliance with incomplete or defective accessories.
- ▶ Replace the accessories in question before operating the appliance.

→ "Accessories", Page 25

**Note:** The appliance has undergone a function test at the factory. This may cause water stains in the appliance, which the first wash cycle removes.

The delivery consists of the following:

- Washing machine
- Accompanying documents
- Transit bolts

→ "Removing the transit bolts", Page 11

- Cover caps
- Water inlet hoses

→ "Connecting the water inlet hoses", Page 12

- Elbow for securing the water outlet hose

### 4.3 Requirements for the installation location

#### ⚠ WARNING

The appliance contains live parts. Touching live parts is dangerous.

- ▶ Do not operate the appliance without a cover cap.

#### ⚠ WARNING

When using the appliance on a base, the appliance may tip over.

- ▶ Always secure the feet of the appliance to a base using the manufacturer's fixing brackets → Page 25 before using the appliance for the first time.

#### NOTICE:

If residual water in the appliance freezes, this may cause damage to the appliance.

- ▶ Do not install or operate this appliance anywhere that is liable to experience frost and/or outdoors.

If the appliance is tilted at an angle greater than 40°, residual water may leak out of the appliance and cause material damage.

- ▶ Tilt the appliance carefully.
- ▶ Transport the appliance in an upright position.

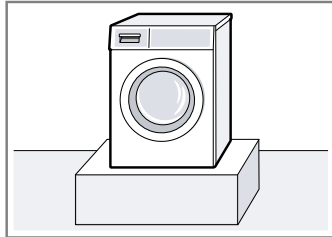
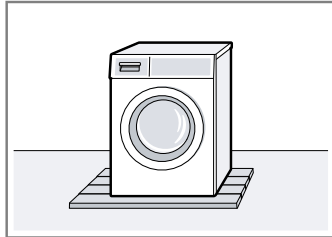
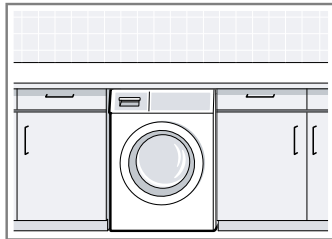
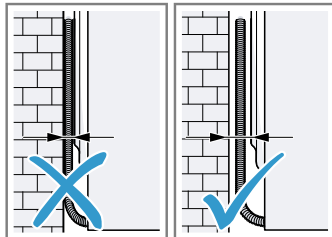
Installation location	Requirements
Base 	Secure the appliance with fixing brackets → Page 25.
Wooden joist floor 	Place the appliance on a water-resistant wooden board (minimum thickness of 1.18 in. (30 mm)) which is screwed tightly to the floor.
Kitchen unit 	Only install the appliance underneath a continuous countertop that is securely connected to adjacent cabinets. Required niche width: 23.6 in. (60 cm).
Against a wall 	Do not trap the power cord or the hoses between the wall and the appliance.

## 4.4 Installation types

The appliance can be set up in a closed cabinet either in a washer-dryer stack or free-standing.

### ⚠ WARNING

If this appliance is not correctly installed in a washer-dryer stack, the installed appliance may fall.

- ▶ Only stack the dryer on a washing machine using the connection kit from the dryer manufacturer. No other installation method is permitted.
- ▶ Do not install the appliance in a washer-dryer stack if the dryer manufacturer does not offer a suitable connection kit.
- ▶ Do not install appliances from different manufacturers and with varying depths and widths in a washer-dryer stack.
- ▶ Do not install a washer-dryer stack on a platform; the appliances may tip over.

### Installation in a closed cabinet

#### Notes

- In case of set up in a washer-dryer stack, please observe the requirements for the installation location.
- When installing in a cabinet, comply with the required minimum dimensions.
- To achieve shorter drying times, operate the appliance with the cabinet door open.  
Operating the appliance in a closed cabinet with only the minimum required ventilation openings may lead to longer drying times.

The specified dimensions of the ventilation opening apply to each position and must not be divided between the upper and lower positions.

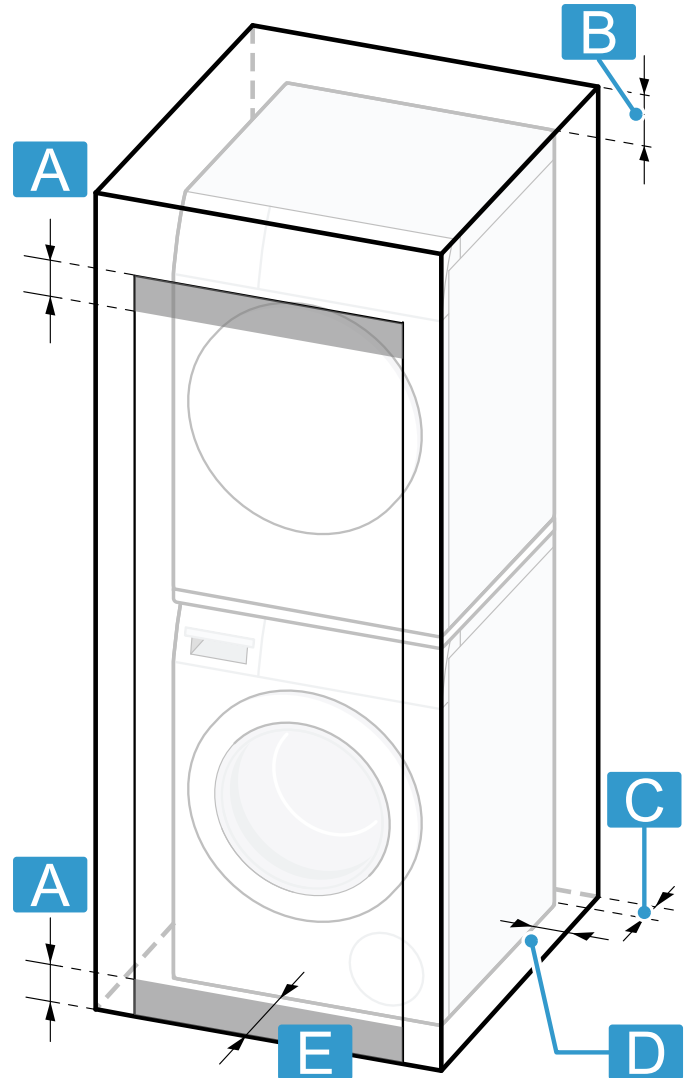

**A** 1.25" (3.2 cm)

**B** 6.25" (16.0 cm)

**C** 3.0" (7.5 cm)

**D** 0.5" (1.3 cm)<sup>1</sup>

**E** 0.5" (1.3 cm)

<sup>1</sup> Valid for both sides of the appliance

The specified dimensions of the ventilation openings apply to each position and must not be divided between the upper and lower positions.

### Installation in an open cabinet

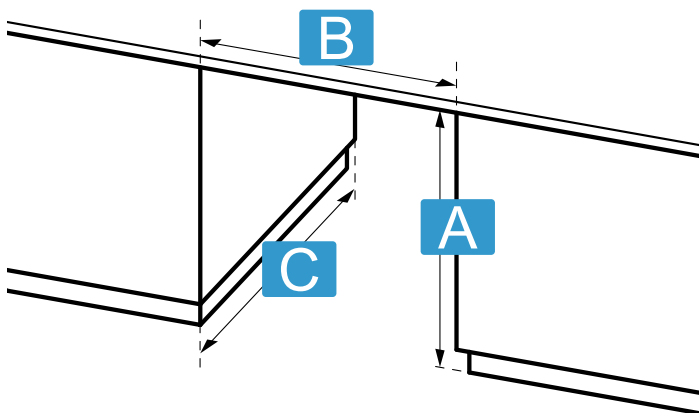

**A** 34.5" (87.6 cm)

**B** 23.8" (60.5 cm)

**C** 28.0" (71.1 cm)

### 4.5 Removing the transit bolts

The appliance is secured for transportation using transit bolts on the rear of the appliance.

**Note:** Keep the transit bolt screws and the sleeves in a safe place for future transport.

→ "Inserting the transit bolts", Page 40

1. Pull the hose out of the holders.

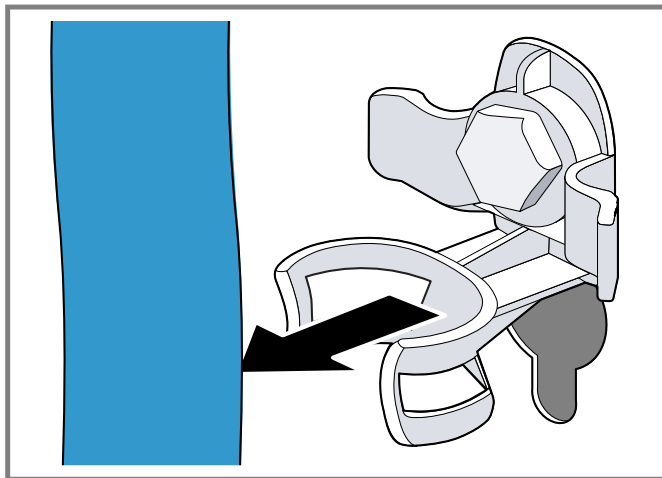

2. Unscrew ① and remove ② all of the screws for the 4 transit bolts using a 13 mm wrench.

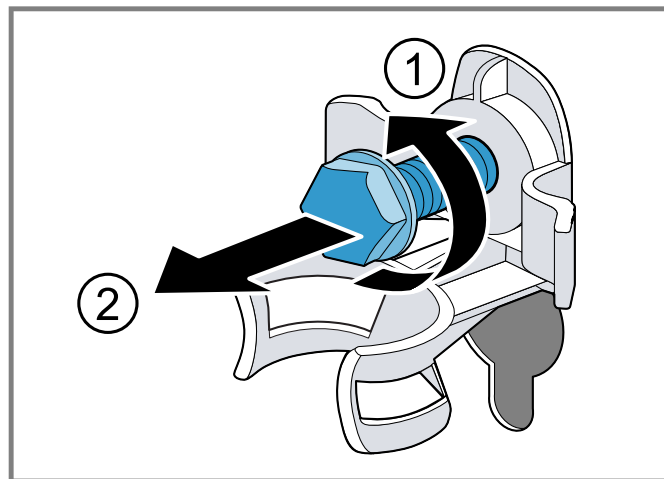

3. Remove the power cord from the holder.

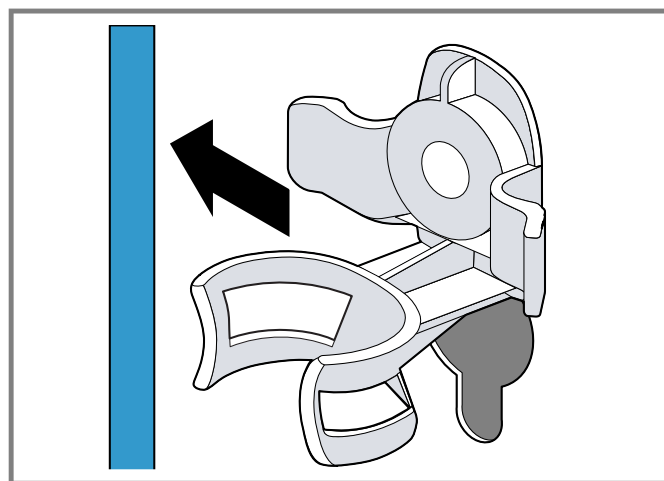

4. Remove the 4 sleeves.

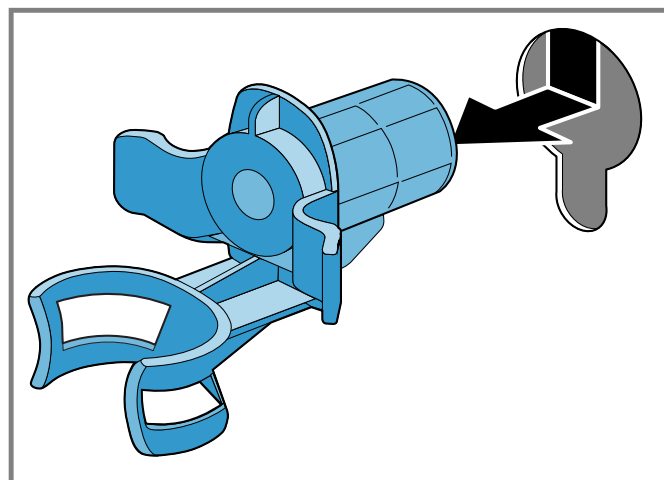

- Put on the 4 cover caps.

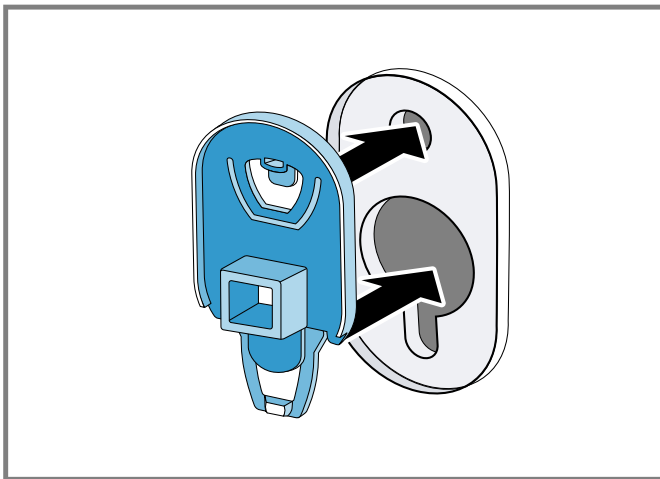

- Push the 4 cover caps downwards.

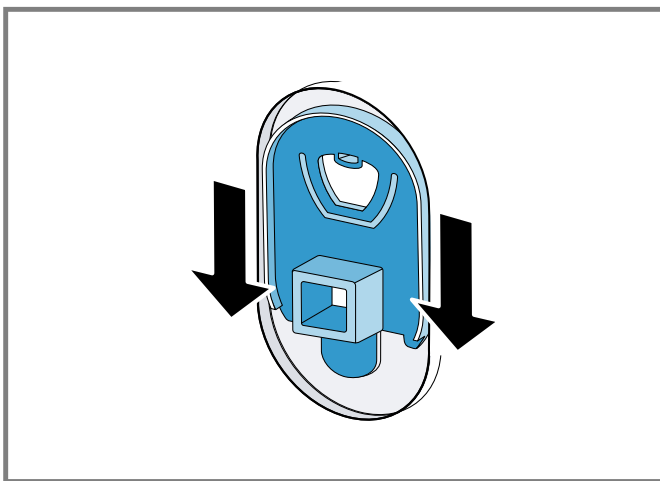

**Note:** To install the transport locks to transport the appliance, perform these steps again in the reverse order.

## 4.6 Connecting the appliance

### Connecting the water inlet hoses

**NOTICE:**

Material damage may be caused if the water inlet hose is connected incorrectly.

- ▶ Tighten the screw connections on the water inlet until they are hand-tight.

- Connect the water inlet hose for hot water **a** (red) and cold water **b** (blue) to the appliance.

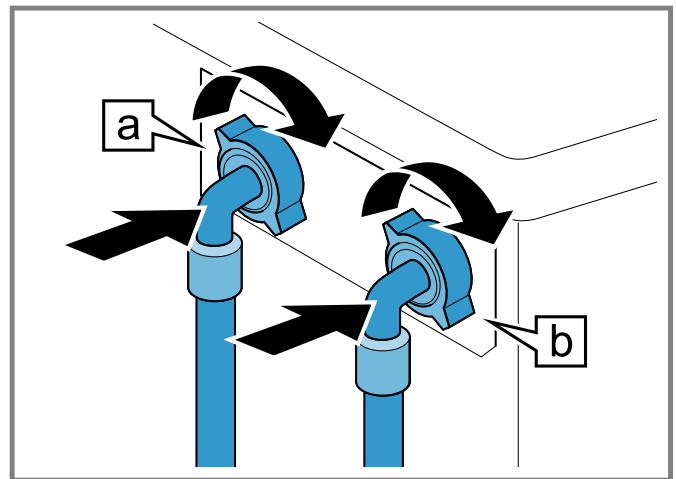

- Connect the water inlet hose for hot water **a** (red) and cold water **b** (blue) to the faucet (26.4 mm = 3/4").

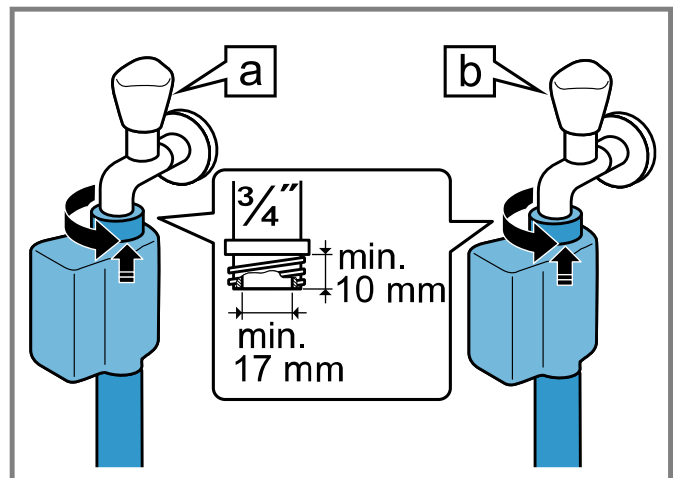

If there is no faucet for hot water, only connect the water inlet hose for cold water. Cover the hot water connection on the appliance in order to protect it from dirt.

**Tip:** To protect against dirt, use a 3/4" end cap on the hot water connection of the appliance.

- Open the faucets carefully and check that the connection points are tight.

### Water outlet connection types

This information is intended to help you to connect this appliance to the water outlet.

**NOTICE:**

When draining, the water drain hose is subject to water pressure and may come loose from the installed connection point.

- ▶ Secure the water drain hose against unintentional loosening.

In the event of a blocked or covered outlet, accumulated wastewater can flow back into the appliance.

- ▶ Before operating the appliance, ensure that the wastewater drains away quickly and eliminate any blockages.

**Note:** Observe the draining heights.  
The maximum draining height is 39 in. (100 cm).

#### Siphon

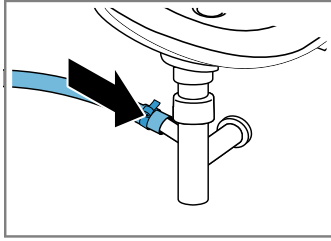

Secure the connection point with a (0.94–1.57 in. (24–40 mm)) hose clamp.

#### Washbasin

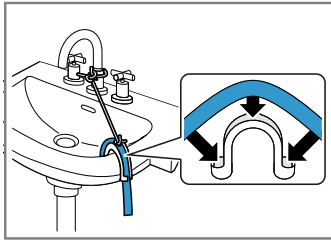

Fix and secure the water outlet hose with an elbow.

#### Plastic pipe with rubber sleeve or gully

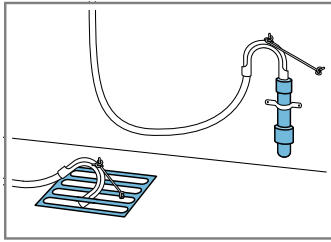

Fix and secure the water outlet hose with an elbow.

### Connecting the appliance to the electricity supply

**Note:** Your electrical domestic installation for this appliance must comply with the local legal provisions and safety regulations, and should include a residual current circuit breaker.

1. Insert the power adapter with the line side into a suitable socket close to the appliance.  
Observe the user manual that is enclosed with the power adapter.
2. Insert the power plug of the appliance's power cord in a socket outlet with grounding nearby.  
The connection details of the appliance can be found under Technical data → Page 41.
3. Check the power plug is inserted properly.

### 4.7 Aligning the appliance

In order to reduce noise and vibrations, and to prevent the appliance from moving, align the appliance correctly.

1. Use a 17 mm wrench to loosen the lock nuts in a clockwise direction.

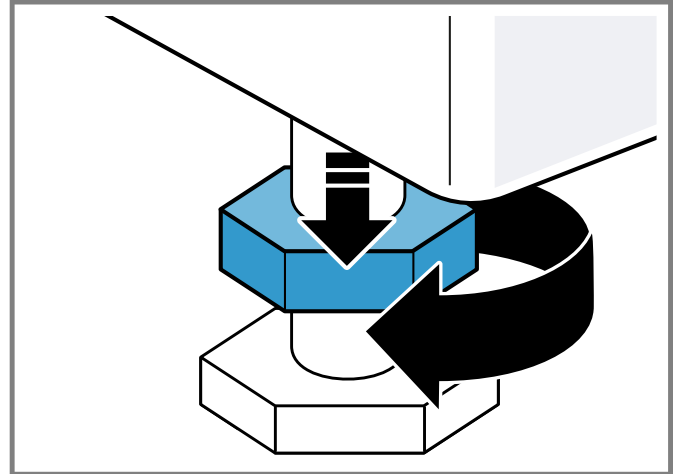

2. To align the appliance, turn the appliance feet. Check that the appliance is level using a spirit level.

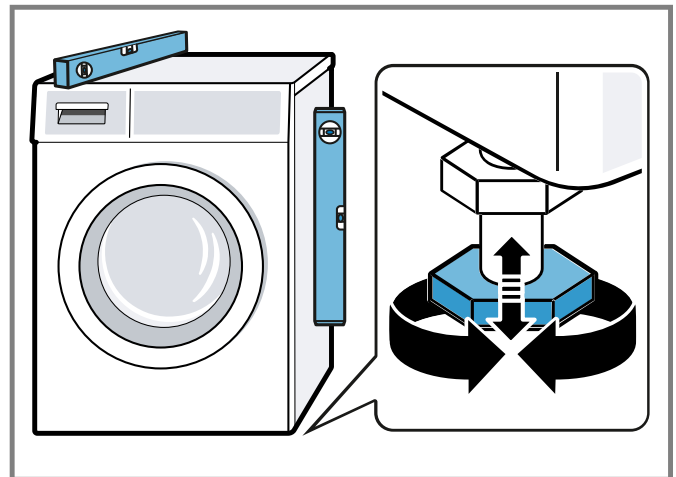

All appliance feet must stand firmly on the ground.

3. Use a 17 mm wrench to tighten the lock nuts against the housing until they are hand-tight.

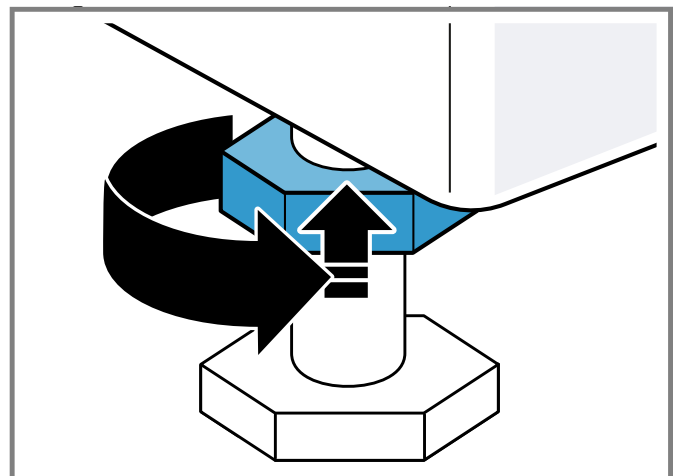

In doing so, hold the appliance foot tight and do not adjust its height.

## 5 Before using for the first time

Prepare the appliance for use.

### 5.1 Starting an empty washing cycle

Your appliance was inspected thoroughly before leaving the factory. To remove any residual water, run the first wash cycle without any laundry.

1. Press .

The switch-on process takes a few seconds.

2. Set the **Drum Clean** program.
3. Close the door.
4. Pull out the detergent drawer.
5. Pour approximately 4.3 cups (1 liter) of mains water into the manual dosing compartment.

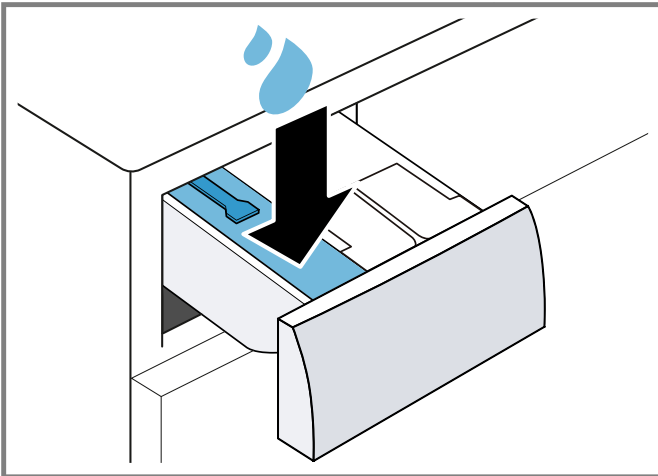

6. Add washing powder containing oxygen bleach to the manual dosing compartment.

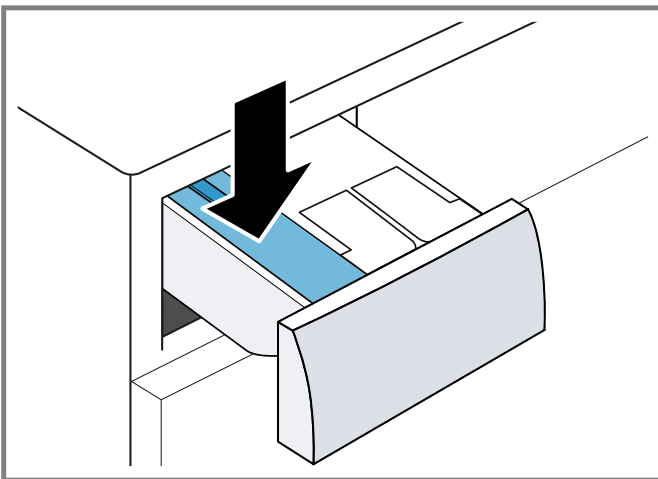

To prevent foaming, use only half of the amount of detergent recommended by the detergent manufacturer for light soiling. Do not use detergent suitable for woollens or delicates.

7. Push in the detergent drawer.
  8. Press  to start the program.
- ✓ The display shows the remaining program duration.
  - ✓ After the program has ended, the display shows: **End**.

9. Start the first wash cycle or press  to put the appliance in standby mode.

→ "Basic Operation", Page 25

## 6 Familiarizing yourself with your appliance

### 6.1 Appliance

Here you can find an overview of the parts of your appliance.

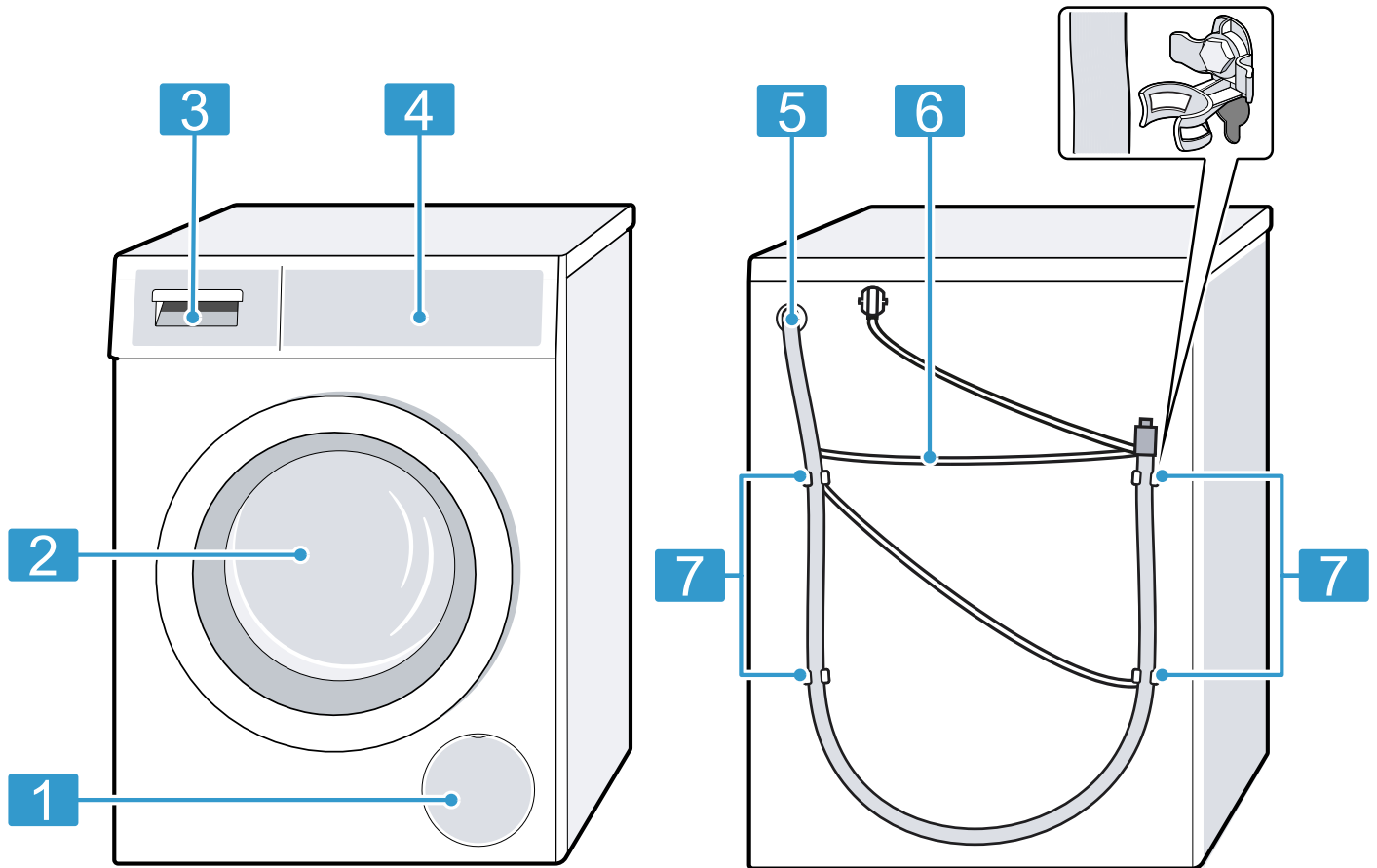

On certain models, specific details such as the color and shape may differ from those pictured.

- |   |  |
|---|--|
| 1 | Maintenance flap for the drain pump → <i>Page 32</i> |
| 2 | Door → <i>Page 26</i>                                |
| 3 | Detergent drawer → <i>Page 15</i>                    |
| 4 | Control panel → <i>Page 16</i>                       |
| 5 | Water drain hose → <i>Page 12</i>                    |
| 6 | Power cord → <i>Page 13</i>                          |
| 7 | Transit bolts → <i>Page 11</i>                       |

### 6.2 Detergent drawer

**Note:** Observe the manufacturer's instructions on the use and dosage of the detergent and care product and the information in the program descriptions.

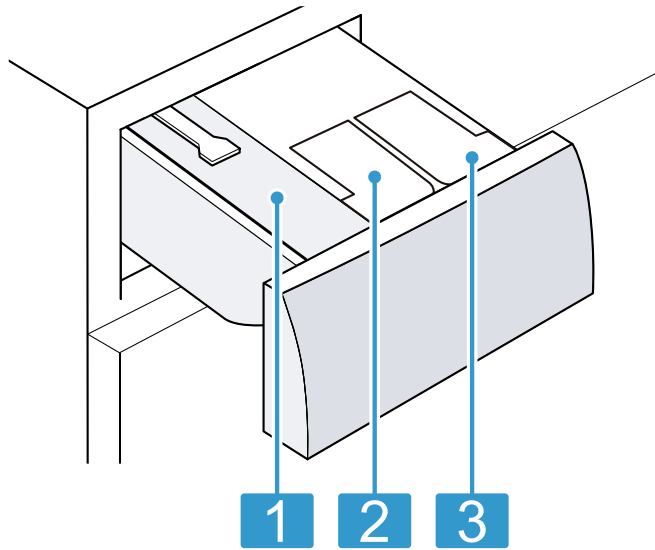

- 
- 1** Manual dosing compartment  
→ "Using the manual dosing compartment",  
Page 28

---

  - 2** ☼ / ∅ : Dispenser for fabric softener or liquid  
detergent  
→ "Intelligent dosing system", Page 27

---

  - 3** ∅ : Dispenser for liquid detergent  
→ "Intelligent dosing system", Page 27
- 

### 6.3 Control panel

You can use the control panel to configure all functions of your appliance and to obtain information about the operating status.

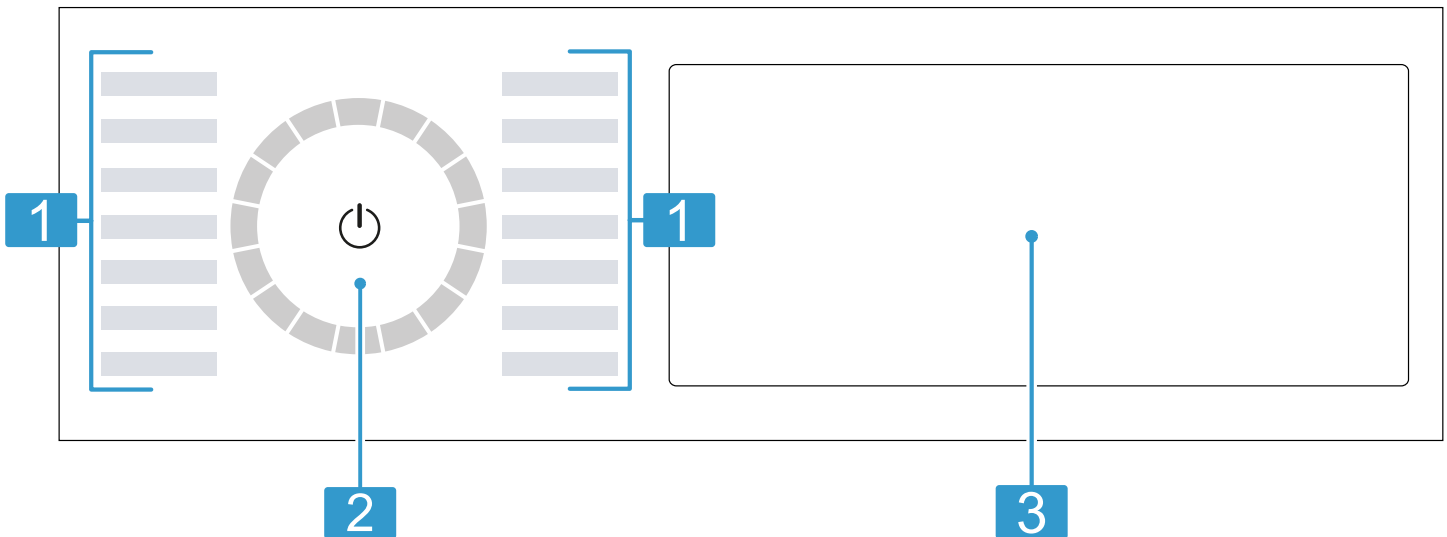

- 
- 1** Programs → Page 22

---

  - 2** Program selector → Page 25

---

  - 3** Buttons → Page 20 and display → Page 18
- 

### 6.4 Operating logic

Some areas of the display are buttons and respond to touch. You can activate, deactivate or change settings by pressing the buttons. The activated settings are highlighted brightly on the display.

**NOTICE:**

Pressing on the display with force may cause damage.

- ▶ Do not apply heavy pressure on the display.
- ▶ Do not press on the display using pointed or sharp objects.



## Displaying or hiding additional buttons

Some buttons are hidden for a reduced display. If you display these additional buttons on the display, you can activate or deactivate the corresponding settings.

1. To display the additional buttons, briefly press **More**.

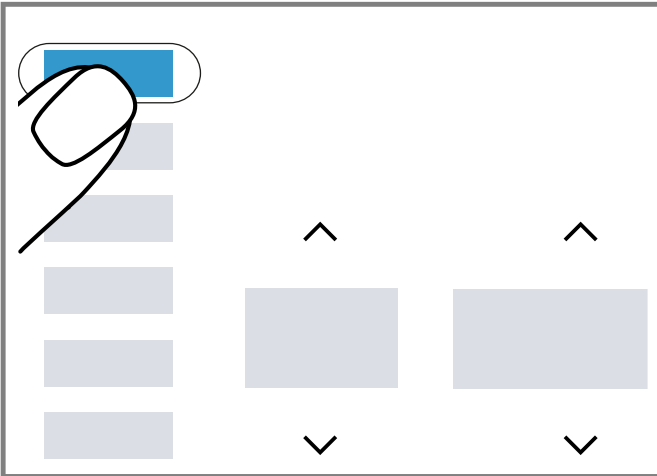

- ✓ The display shows all additional buttons.

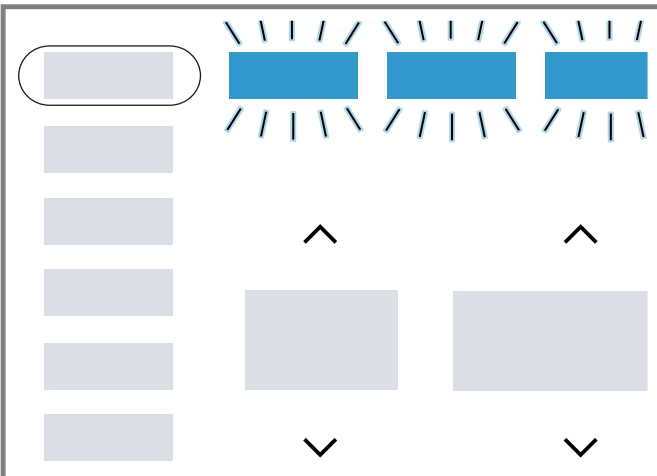

2. To hide the additional buttons, briefly press **More** again.

## Changing a setting value

If you activate certain settings, the display shows selection buttons and you can change the setting value.

- ▶ Press the selection buttons → *Page 20*.

The display shows the setting value.

## 7 Display

The display shows the current settings, options or relevant information.

Depending on the program status, the display shows some information in the **00:00** area, e.g. End.

**Note:** Additional functions may be available as a result of software updates. → Page 29



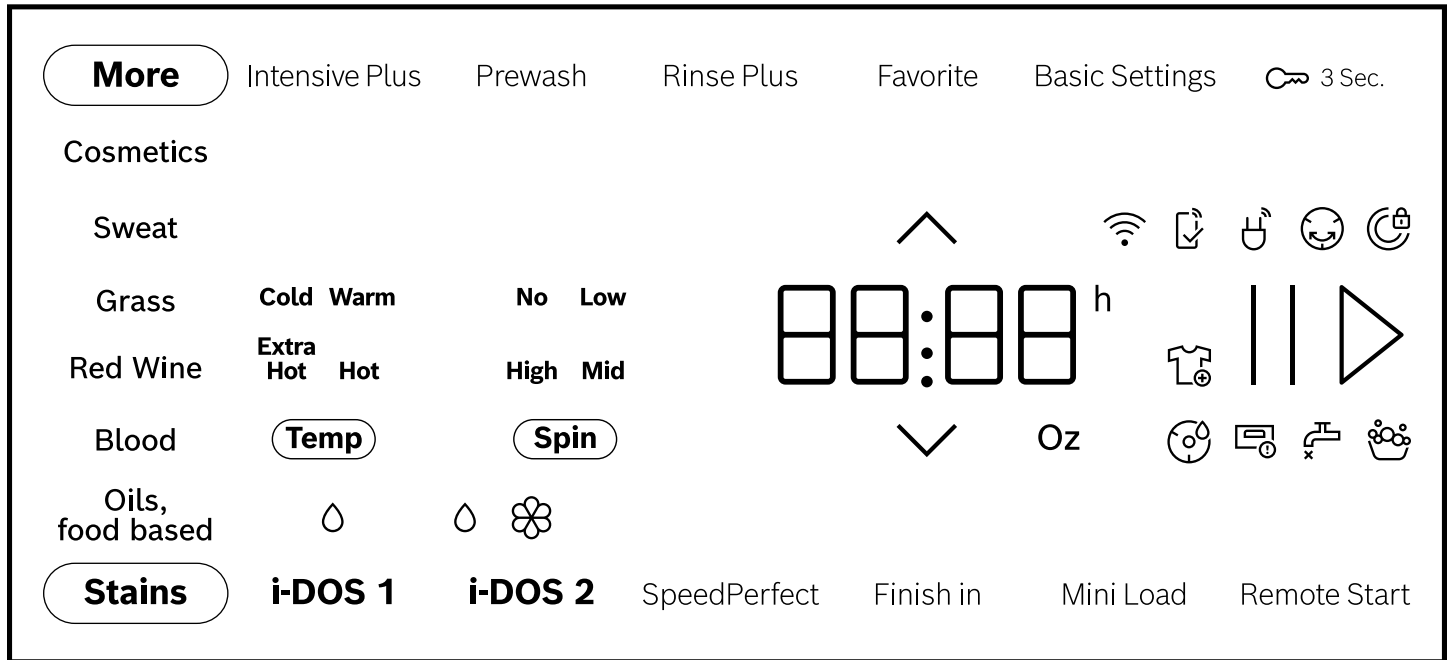











If a software update is available, you can find further information in the Home Connect® app.



Example: Display

Display	Description
00:40 <sup>1</sup>	Expected program duration or program time remaining in hours and minutes.
10 h <sup>1</sup>	Program end time → "Buttons", Page 20
No (Spin) - High	Set spin speed. → Page 20 No (Spin): No spin cycle, draining only
Cold - Extra Hot	Set temperature. → "Buttons", Page 20
	You can remove or add laundry, and interrupt the current program. → Page 27
End	Program status: Program end
	<ul style="list-style-type: none"> <li>■ Lights up: The control panel lock is activated.</li> <li>■ Flashes: The control panel lock is activated and the appliance has been operated.</li> </ul>
Blood	The "Blood" stain type is activated.
Grass	The "Grass" stain type is activated.
Cosmetics	The "Cosmetics" stain type is activated.
Red Wine	The "Red wine" stain type is activated.
Sweat	The "Sweat" stain type is activated.
Oils, food based	The "Cooking fat/cooking oil" stain type is activated.
	Flashes: Drum cleaning is required. Run the Drum Clean program for cleaning and caring for the drum and the outer tub. → "Cleaning the drum", Page 30
	Remote start is activated. → Page 20

<sup>1</sup> Example

Display	Description
	<ul style="list-style-type: none"> <li>▪ Lights up: The appliance is connected to your home network via Wi-Fi.</li> <li>▪ Flashes: The appliance is trying to connect to your home network via Wi-Fi.</li> </ul> <p>→ "Home Connect® ", Page 28</p>
	The appliance is connected to the smart energy system (energy manager).
	<ul style="list-style-type: none"> <li>▪ Lights up: The intelligent dosing system for liquid detergent is activated.</li> <li>▪ Flashes: The fill level of the dispenser is below the minimum level. → Page 28</li> </ul> <p> (liquid detergent)</p>
 	<ul style="list-style-type: none"> <li>▪ Lights up: The intelligent dosing system for liquid detergent or fabric softener is activated.</li> <li>▪ Flashes: The fill level of the dispenser is below the minimum level. → Page 28</li> </ul> <p> (liquid detergent)  (fabric softener)</p>
1.5 Oz <sup>1</sup>	Basic dosage for detergent or fabric softener. → Page 28
	The appliance has detected too much foam. →  or heavy foam build-up.", Page 37
	<ul style="list-style-type: none"> <li>▪ Lights up: The door is locked. <ul style="list-style-type: none"> <li>– To add laundry, the door can be unlocked if  lights up. <ul style="list-style-type: none"> <li>→ "Adding laundry", Page 27</li> </ul> </li> <li>– To open the door, you can cancel the program. <ul style="list-style-type: none"> <li>→ "Terminating the program", Page 27</li> </ul> </li> </ul> </li> <li>▪ Flashes: The door is not closed.</li> </ul>
	<ul style="list-style-type: none"> <li>▪ No water pressure.</li> <li>▪ The water pressure from the tap is too low.</li> </ul>
	The detergent drawer has not been pushed in fully. →  ", Page 37
E:35 <sup>1</sup>	Error code, error display, signal. → Page 36
<sup>1</sup> Example	

## 8 Buttons

**Note:** Additional functions may be available as a result of software updates.





→ "Installing a software update", Page 29

If a software update is available, you can find further information in the Home Connect® app.

Some buttons are hidden for a reduced display. You can display these additional buttons on the display.

→ "Displaying or hiding additional buttons", Page 17

The selection of program settings depends on the program that is set.

Button	Selection	More information
II ▷ (Start/Pause Reload)	<ul style="list-style-type: none"> <li>■ Start</li> <li>■ Cancel</li> <li>■ Pause</li> </ul>	Start, cancel or pause the program. If II is displayed, you can pause the program. If ▷ is displayed, you can start the program.
∧ ∨	Multiple selection	To change a setting, press the ∧ or ∨ selection button until the display shows the required setting.
SpeedPerfect	<ul style="list-style-type: none"> <li>■ Activate</li> <li>■ Deactivate</li> </ul>	Activate or deactivate a shorter program duration. <b>Note:</b> Energy consumption increases. The washing result is not affected by this.
Intensive Plus	<ul style="list-style-type: none"> <li>■ activate</li> <li>■ deactivate</li> </ul>	Activate or deactivate an extended washing program. The program duration is extended by up to 30 minutes. Suitable for heavily soiled laundry.
Stains	Multiple selection	Select the type of stain. The temperature, drum movement and soaking time are all adjusted to suit the type of stain.
i-DOS 1	<ul style="list-style-type: none"> <li>■ Activate</li> <li>■ Deactivate</li> <li>■ Setting the basic dosage amount</li> </ul>	Briefly press the button to activate or deactivate the intelligent dosing system for liquid detergent  . Press and hold the button for approximately 3 seconds to set the basic dosage. → Page 28
i-DOS 2	<ul style="list-style-type: none"> <li>■ Activate</li> <li>■ Deactivate</li> <li>■ Adapting the dispenser</li> <li>■ Setting the basic dosage amount</li> </ul>	Briefly press the button to activate or deactivate the intelligent dosing system for fabric softener  or liquid detergent  . Press the button for approximately 3 seconds to adapt the contents of the  dispenser or set the basic dosage. → "Intelligent dosing system", Page 27
Finish in	Up to 24 hours	Set the program end time. The program duration is already included in the set number of hours. Once the program has started, the program duration is displayed. <b>Note:</b> Press ∧ or ∨ until the display shows the required setting.
Temp	Cold - Extra Hot	Adjust the temperature.
Spin	No (Spin) - High	Adjust the spin speed or deactivate the spin cycle. If No (Spin) is selected, the water is drained and the spin cycle is deactivated. The laundry stays wet inside the drum.
⏻ (mains switch)	<ul style="list-style-type: none"> <li>■ Switch on</li> <li>■ Standby mode</li> <li>■ Restart the appliance</li> </ul>	Switch on the appliance or put it in standby mode. If the control panel does not respond, press and hold ⏻ for approximately 5 seconds to restart the appliance. → "The display and buttons do not respond.", Page 37
Remote Start	<ul style="list-style-type: none"> <li>■ Activate</li> <li>■ Deactivate</li> <li>■ Opening the Home Connect® settings</li> </ul>	Activate or deactivate remote start. → Page 29
🔒 3 sec.	<ul style="list-style-type: none"> <li>■ Activate</li> <li>■ Deactivate</li> </ul>	→ "Control panel lock", Page 27

<b>Button</b>	<b>Selection</b>	<b>More information</b>
Basic Settings	Multiple selection	→ <i>"Basic settings", Page 30</i>
More	<ul style="list-style-type: none"> <li>■ Displaying or hiding additional buttons</li> </ul>	<ul style="list-style-type: none"> <li>■ If you briefly press the button, you can display or hide additional buttons.</li> </ul> → <i>"Displaying or hiding additional buttons", Page 17</i>
Mini Load	<ul style="list-style-type: none"> <li>■ Activate</li> <li>■ Deactivate</li> </ul>	Wash small loads of delicate or hard-wearing fabrics. The program duration is shortened, and the water and energy consumption adjusted to the load. <b>Note:</b> If you activate the setting, the program's maximum load capacity is reduced to 1.1 lbs (0.5 kg).
Prewash	<ul style="list-style-type: none"> <li>■ Activate</li> <li>■ Deactivate</li> </ul>	Activate or deactivate prewash, e.g., for washing heavily soiled laundry. <b>Note:</b> If the intelligent dosing system is activated, the detergent will be dispensed automatically for the prewash and the main wash. If the intelligent dosing system is deactivated, place the detergent directly in the drum for the prewash and into the manual dosing compartment for the main wash. → <i>"Detergent drawer", Page 15</i>
Rinse Plus	<ul style="list-style-type: none"> <li>■ Activate</li> <li>■ Deactivate</li> </ul>	Activate or deactivate an additional rinse cycle. Recommended for particularly sensitive skin or in regions with very soft water.
Favorite	<ul style="list-style-type: none"> <li>■ Save</li> <li>■ Set</li> </ul>	Press the button for approx. 3 seconds to save your customized program settings. → <i>"Saving the program settings", Page 26</i> If you briefly press the button, you can set customized program settings for your program.

## 9 Programs

### Notes

- The laundry's care labels provide you with additional information on program selection.
- The program's temperature setting guarantees that the recommended temperature on the care label is not exceeded. The temperature that is reached in the appliance may differ from the set temperature. This means that the best possible washing performance is achieved with optimal energy efficiency.
- Additional functions may be available as a result of software updates. → *Page 29*  
If a software update is available, you can find further information in the Home Connect® app.

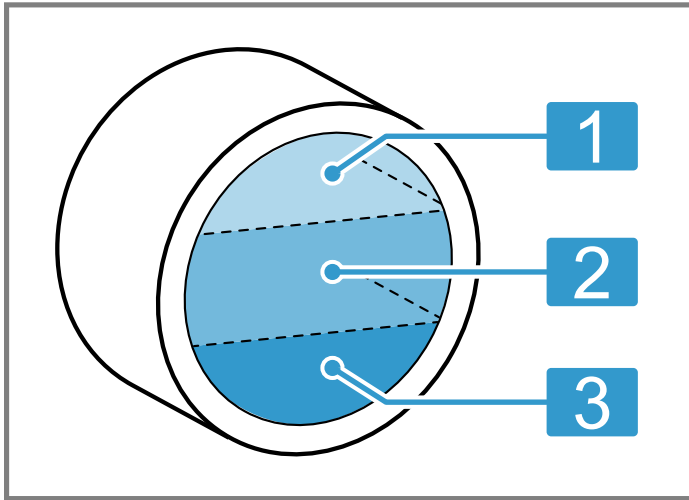

- 1 Large load
- 2 Medium load
- 3 Small load

Program	Description	Max. load
Cotton	Wash hard-wearing items made from cotton or linen. Suitable for normally soiled laundry. Program setting: <ul style="list-style-type: none"> <li>■ Max. temperature: Extra Hot</li> <li>■ Max. spin speed: High</li> </ul>	large medium <sup>1</sup>
Whites	Wash white hard-wearing items made from cotton or linen. Suitable for heavily to lightly soiled laundry. Program setting: <ul style="list-style-type: none"> <li>■ Max. temperature: Extra Hot</li> <li>■ Max. spin speed: High</li> </ul>	large
Mix	Wash items made from cotton, linen, or synthetic fabrics. Suitable for lightly soiled laundry. Program setting: <ul style="list-style-type: none"> <li>■ Max. temperature: Extra Hot</li> <li>■ Max. spin speed: High</li> </ul>	medium
Sanitize	Wash hard-wearing items made from cotton or linen. Wash with more water and at a defined temperature. Suitable for allergy-sufferers and for strict hygiene requirements. Program setting: <ul style="list-style-type: none"> <li>■ Temperature: Extra Hot</li> <li>■ Max. spin speed: High</li> </ul>	medium

<sup>1</sup> SpeedPerfect activated

<sup>2</sup> Washing not possible

Program	Description	Max. load
Delicates	<p>Wash delicate, washable items made from silk, viscose, or synthetic fabrics. Use a detergent that is suitable for delicates or silk.</p> <p><b>Note:</b> Wash especially delicate items or items with hooks, eyelets or clips in a mesh laundry bag.</p> <p><b>Tip:</b> Gently cleaning the laundry reduces abrasion of textile fibers and microplastic fibers.</p> <p>Program setting:</p> <ul style="list-style-type: none"> <li>■ Max. temperature: Hot</li> <li>■ Max. spin speed: Mid</li> </ul>	small
Hand Wash/Wool	<p>Wash hand- or machine-washable items that are made from wool or contain wool.</p> <p>To prevent the laundry from shrinking, the drum moves the items very gently with long pauses.</p> <p>Use a detergent that is suitable for wool.</p> <p>Program setting:</p> <ul style="list-style-type: none"> <li>■ Max. temperature: Hot</li> <li>■ Max. spin speed: Mid</li> </ul>	small
Rinse	<p>Rinses and then spins the laundry, and then drains the water.</p> <p>Program setting: Max. spin speed: High</p>	–
Spin/Drain	<p>Spins the laundry and drains the water.</p> <p>If you only want to drain the water, activate No (Spin). The laundry is not spun.</p> <p>Program setting: Max. spin speed: High</p>	–
 App Programs	<p>Select additional programs directly via the Home Connect® app. A description of the programs can be found in the Home Connect® app.</p> <p><b>Note:</b> Your appliance must be connected to your home network and registered in your Home Connect® app. → <i>Page 28</i></p>	–
Towels	<p>Wash hard-wearing items made from cotton, e.g. towels and bathrobes.</p> <p>Program setting:</p> <ul style="list-style-type: none"> <li>■ Max. temperature: Extra Hot</li> <li>■ Max. spin speed: High</li> </ul>	medium
Automatic	<p>Wash hard-wearing items made from cotton or synthetic fabrics. The degree of soiling and the type of fabric are automatically detected. The washing process is adapted.</p> <p><b>Note:</b> The temperature and spin speed cannot be adjusted in this program and are set automatically.</p> <p>The maximum temperature is Hot</p> <p>The maximum spin speed is High</p>	medium
Bedding	<p>Wash pillows or quilts stuffed with synthetic fibers, or down fillings. Wash large items separately.</p> <p>Use a detergent that is suitable for down or delicates.</p> <p>Use sparingly.</p> <p>Do not use fabric softener.</p> <p><b>Note:</b> To prevent excessive foaming, remove air from laundry items by rolling them up before you wash them.</p> <p>Program setting:</p> <ul style="list-style-type: none"> <li>■ Max. temperature: Extra Hot</li> <li>■ Max. spin speed: High</li> </ul>	small

<sup>1</sup> **SpeedPerfect** activated

<sup>2</sup> Washing not possible

Program	Description	Max. load
Jeans	<p>Wash dark-colored and color-intense items made from cotton or permanent press fabric, e.g. jeans.</p> <p>Turn laundry inside-out before washing.</p> <p>Use liquid detergent.</p> <p>Program setting:</p> <ul style="list-style-type: none"> <li>■ Max. temperature: Hot</li> <li>■ Max. spin speed: High</li> </ul>	medium
Drum Clean	<p>Clean and care for the drum.</p> <p>Use this program in the following cases:</p> <ul style="list-style-type: none"> <li>■ Before using the appliance for the first time</li> <li>■ If you regularly wash at temperatures of Hot or lower</li> <li>■ After an extended period of non-use</li> </ul> <p>Use washing powder containing oxygen bleach. Add washing powder containing oxygen bleach to the manual dosing compartment. → <i>Page 15</i></p> <p>Halve the amount of detergent to avoid foaming.</p> <p>Do not use fabric softener.</p> <p>Do not use liquid detergent or detergent that is intended for woolens or delicates.</p> <p><b>Note:</b> The drum cleaning indicator flashes to remind you if you have not used a program at temperature of Extra Hot for a long time.</p>	— <sup>2</sup>
SuperQuick 15/30	<p>Wash items made from cotton or synthetic fabrics.</p> <p>Short program for small items of lightly soiled laundry.</p> <p><b>Note:</b> To adjust the program duration, activate or deactivate SpeedPerfect.</p> <p>Program setting:</p> <ul style="list-style-type: none"> <li>■ Max. temperature: Hot</li> <li>■ Max. spin speed: High</li> </ul>	medium small <sup>1</sup>

<sup>1</sup> **SpeedPerfect** activated

<sup>2</sup> Washing not possible



## 10 Accessories

Only use original accessories. These are designed especially for your appliance.

**Tip:** Some accessories are available in other colors.

Contact customer service. → *Page 40*

	Use	Order number
Water inlet hose extension	Extend the water inlet hose for cold water or Aquastop (approx. 2.50 m / 98,4 in).	WMZ2381
Water outlet hose extension	Extend the water outlet hose (2.20 m/86.6 in).	11057910
Fixing brackets	Improves the stability of the appliance.	WMZ2200
Platform	Install the appliance at a raised height so that it can be easily loaded and unloaded.	WMZPW2XW
Washing machine cleaners	Cleaning product for maintaining the appliance interior.	00311928
Power adapter	Connect the appliance to a NEMA 14-30 (4-pin) outlet.	WTZPA20UC

## 11 Laundry

### 11.1 Preparing the laundry

#### **NOTICE:**

Objects remaining in the laundry may damage the laundry and the drum.

- ▶ Remove all items from any pockets in your laundry before using the appliance.

#### **Note**

The appliance and fabrics are protected when you prepare your laundry.

- Brush off sand and soil
- Sort the laundry according to color and fabrics and observe the care labels
- Close all zippers, hook and loop fasteners, hooks and eyes
- Tie cloth belts, cloth straps and cords together
- Remove curtain fittings and lead strips
- Wash small or particularly delicate items in a mesh washing bag
- Wash large and small items of laundry together
- Wash laundry with fresh stains immediately
- Pretreat laundry with dried stains and wash several times
- Load the laundry unfolded into the drum
- Before loading the drum, any laundry that has been pre-treated with chlorine bleach should be rinsed several times

## 12 Detergents and care products

You can protect your appliance and your laundry by selecting and using the correct detergents and care products.

The manufacturer's instructions for use and dosage can be found on the packaging.

#### **Notes**

- when using liquid detergents, only use liquid detergents that are self-flowing
- Do not mix different liquid detergents
- Do not mix detergent and fabric softener
- Do not use products that have expired or are highly congealed
- do not use products containing solvents, caustic agents or volatile substances
- Do not use chlorine bleach
- Do not use dyes regularly as fixing salt can damage stainless steel
- Do not use color-bleaching agents in the appliance
- Do not pour vinegar into the dispensers → *Page 28* of the intelligent dosing system

## 13 Basic Operation

### 13.1 Switching on the appliance

**Note:** If you switch the appliance on the first time after you have connected it to the electrical system, the switch-on process takes up to one minute.

**Requirement:** The appliance has been correctly installed and connected. → *Page 9*

- ▶ Press .

The switch-on process takes a few seconds.

- ✓ An audible function test is carried out.

**Note:** The lighting for the drum goes out automatically.

### 13.2 Setting a program

1. Press the required program.  
→ "Programs", Page 22

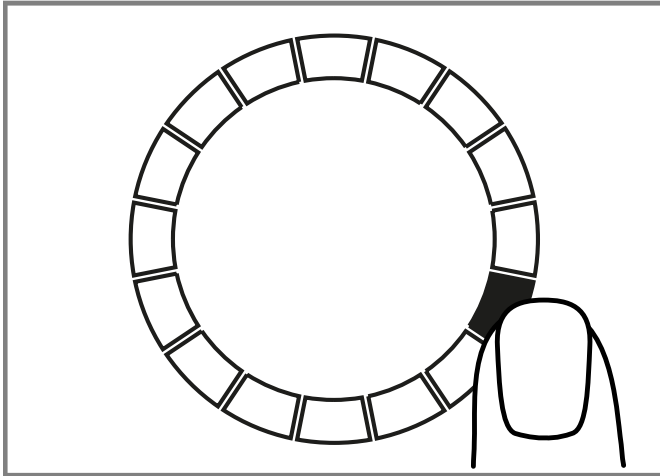

- ✓ The display shows the program settings.
2. Adjust the program settings.  
→ "Buttons", Page 20  
Observe the information about operating logic  
→ Page 16.  
The program settings are not saved permanently for the program.

**Note:** The setting is saved if you activate or deactivate the intelligent dosing system.

### Setting additional programs

**Requirement:** Home Connect® is set up. → Page 29

1. Set the  **App Programs** program.
- ✓ **Remote Start** flashes.
2. Press **Remote Start**.
- ✓ The Home Connect® app displays the programs that can be selected.
3. Set a program in the Home Connect® app.
  4. If required, adjust the program settings.  
→ "Buttons", Page 20
  5. Start the program. → Page 26

### 13.3 Saving the program settings

You can save your individual program settings as favorites.

**Requirement:** A program has been set. → Page 25

- ▶ Press and hold **Favorite** for approximately 3 seconds.  
Press **Favorite** to call up the saved program.

**Note:** To overwrite the saved program, repeat the steps above.

### 13.4 Opening the door

1. Grip under the door handle and pull on the door.

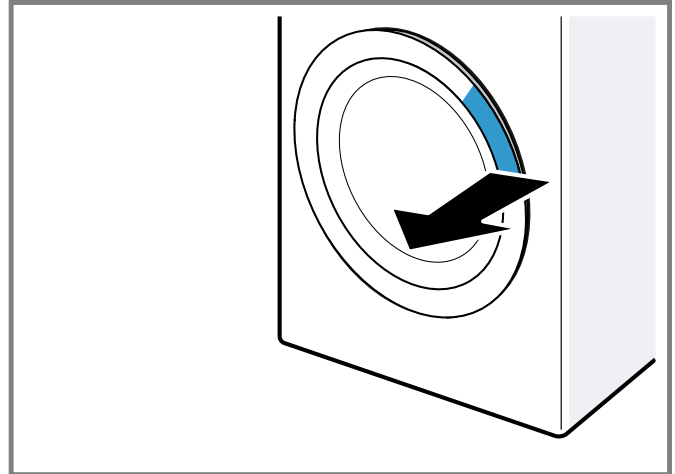

2. Open the door.

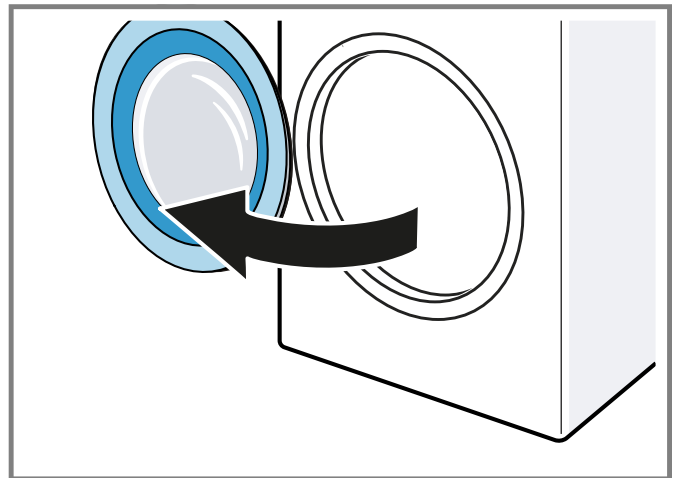

### 13.5 Loading laundry

**Note:** To prevent creasing, note the maximum load for the programs.

→ "Programs", Page 22

#### Requirements

- The laundry is prepared and sorted.  
→ "Laundry", Page 25
- The drum is empty.

1. Open the door. → Page 26
2. Place the laundry in the drum.
3. Close the door.  
Ensure that there is no laundry trapped in the door.

### 13.6 Starting the program

**Note:** If the intelligent dosing system is activated, make sure that the dispensers have been filled → Page 28 and the basic dosage has been set → Page 28.

**Requirement:** A program has been set. → Page 25

- ▶ Press **II ▷**.

- ✓ The drum rotates and load detection takes place. This can take up to 2 minutes, after which water enters the drum.
- ✓ The display shows the program duration or the program end time.
- ✓ After the program has ended, the display shows: **End**.

### 13.7 Soaking laundry

**Note:** No additional detergent is required for soaking. The appliance uses the filled detergent for soaking and washing.

#### Requirements

- The laundry is placed in the appliance. → *Page 26*
- A program has started. → *Page 26*

1. Press **II ▷** approx. 10 minutes after the program start.  
The program pauses and the laundry can soak.
2. Press **II ▷** after the required soaking time.

### 13.8 Adding laundry

After the program starts, you can remove or add laundry depending on the program status.

1. Press **II ▷**.

The appliance pauses.

**Note:** If you want to add laundry, follow the instructions on the display.

→ *"Display", Page 19*

→ *"Display", Page 18*

2. Open the door. → *Page 26*
3. Add or remove laundry.
4. Close the door.
5. Press **II ▷**.

### 13.9 Terminating the program

1. Press **II ▷**.
2. Open the door. → *Page 26*

The appliance door remains locked for safety reasons if the temperature and water levels are high.

- If the temperature is high, start the **Rinse** program.
- If the water level is high, start the **Spin** program or select a suitable program for draining.  
→ *"Programs", Page 22*

3. Remove the laundry. → *Page 27*

### 13.10 Removing the laundry

1. Open the door. → *Page 26*
2. Remove the laundry from the drum.

### 13.11 Put the appliance into standby mode

1. Press **⏻**.
2. Turn off the tap.

3. Wipe the rubber gasket dry and remove any foreign objects.

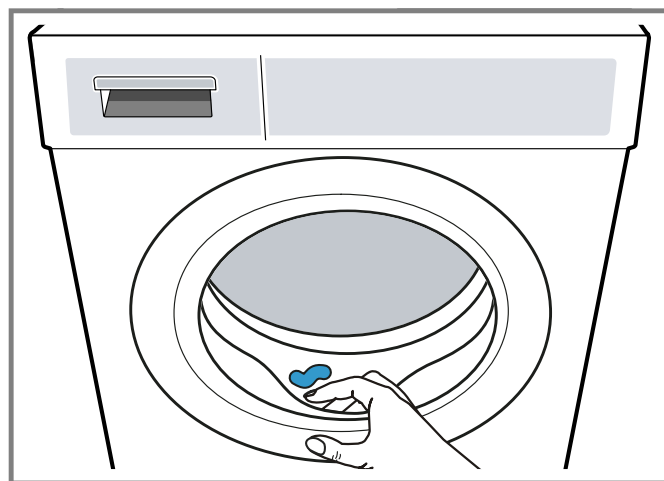

4. Leave the appliance door and detergent drawer open so that residual water can evaporate.

## 14 Control panel lock

Secure your appliance against being operated unintentionally using the controls.

### 14.1 Activating the control panel lock

- ▶ Press and hold **☰ 3 sec.** for around 3 seconds.
- ✓ The display shows **☰**.
- ✓ The control elements are locked.
- ✓ The control panel lock also remains activated when the appliance is in standby mode and in the event of a power failure.

### 14.2 Deactivating the control panel lock

**Requirement:** To deactivate the control panel lock, the appliance must be switched on.

- ▶ Press and hold **☰ 3 sec.** for around 3 seconds.
- ✓ **☰** goes out on the display.

## 15 Intelligent dosing system

The appliance's intelligent dosing system is activated at the factory and automatically doses liquid detergent and fabric softener for any programs in which intelligent dosing is possible.

**Note:** You can use the buttons → *Page 20* to deactivate the intelligent dosing system, e.g. in order to manually dose washing powder → *Page 28*.

## 15.1 Pouring liquid detergent and fabric softener into the dispensers

If you are using the intelligent dosing system or if the appliance displays a notification during operation of the appliance, fill the dispensers.

### Notes

- Only pour suitable liquid detergent and fabric softener into the dispensers. → *Page 25*
- If you add more liquid detergent or fabric softener to the dispenser, use the same product.
- If you want to replace the liquid detergent or fabric softener in the dispenser with another product, clean the detergent drawer beforehand → *Page 30*.
- If you are using the intelligent dosing system, do not add additional detergent or fabric softener into the compartment for manual dosing. This is to prevent overdosing or foam formation.

1. Pull out the detergent drawer.
2. Open the lid and pour liquid detergent  $\hat{\circ}$  and fabric softener  $\otimes$  into the relevant dispensers → *Page 15*.

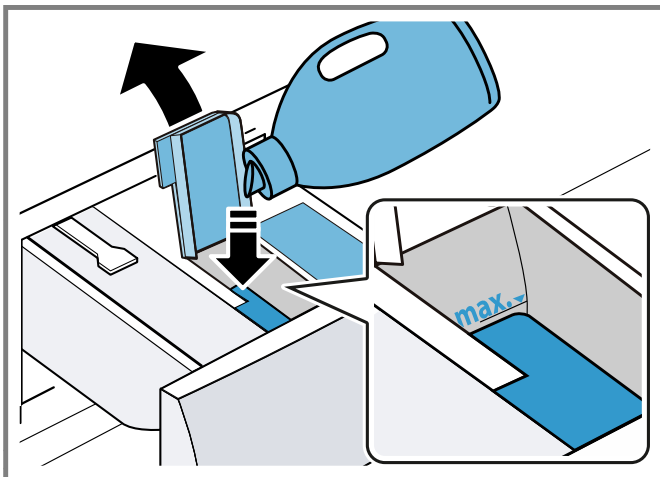

Do not exceed the marking for the maximum fill level when filling.

**Note:** You can also use both dispensers for liquid detergent. Adapt the dispenser for this. → *Page 28*

3. Close the lid.

**Note:** To prevent the liquid detergent or fabric softener from drying out, close the lids immediately after filling.

4. Push in the detergent drawer.

## 15.2 Using the manual dosing compartment

If you are not using the intelligent dosing system, if intelligent dosing is not possible for a program, or if you want to add additional care product, e.g. stain remover or starch, use the manual dosing compartment.

**Note:** Observe the information about detergents and care products → *Page 25*.

1. Pull out the detergent drawer.
2. Pour laundry detergent or care product into the manual dosing compartment → *Page 15*.

3. Push in the detergent drawer.

## 15.3 Adapting the $\otimes/\hat{\circ}$ dispenser

The  $\otimes/\hat{\circ}$  dispenser can dose fabric softener  $\otimes$  or liquid detergent  $\hat{\circ}$ . When it leaves the factory, the dispenser is set for fabric softener. If you want to automatically dose a second liquid detergent, adapt the dispenser.

### Notes

- If you adapt the contents of the dispenser, the basic dosage for this dispenser is reset.
- If you use both dispensers for liquid detergent, you must set a dispenser which is to be used during washing. → *"Buttons", Page 20*

1. Press and hold **i-DOS 2** for approximately 3 seconds.
2. Press **i-DOS 2** repeatedly until the display shows  $\hat{\circ}$  (liquid detergent) or  $\otimes$  (fabric softener).
3. Wait briefly to save the setting.

## 15.4 Setting the basic dosage amount

To allow for intelligent dosing, set the basic dosage amount for the dispenser. The basic dosage amount corresponds to the dosage recommendation from the detergent manufacturer on the packaging. Set the basic dosage amount that corresponds to the dosage recommendation for 11 lbs (5 kg) of normally soiled laundry.

**Tip:** You can also set the basic dosage amount in the Home Connect® app.

1. Press and hold **i-DOS 1** for approximately 3 seconds.
  - ✓ The display shows the set basic dosage amount.
2. To adjust the setting, press  $\wedge \vee$ .
3. Wait briefly to save the setting.

**Note:** To set the basic dosage amount for the other dispenser, repeat the steps with **i-DOS 2**.

## 16 Home Connect®

This appliance is network-capable. Connecting your appliance to a mobile device lets you control its functions via the Home Connect® app, adjust its basic settings and monitor its operating status.

The Home Connect® services are not available in every country. The availability of the Home Connect® function depends on the availability of Home Connect® services in your country. You can find information on this at: [www.home-connect.com](http://www.home-connect.com).

The Home Connect® app guides you through the entire registration process. Follow the instructions in the Home Connect® app to implement the settings.

**Tip:** Follow the instructions in the Home Connect® app as well.

## Notes

- Also note the safety information in this instruction manual and ensure that it is also observed when operating the appliance using the Home Connect® app. → "Safety", Page 4
- Operating the appliance on the appliance itself always takes priority. It is not possible to operate the appliance using the Home Connect® app during this time.

## 16.1 Setting up the Home Connect® app

1. Install the Home Connect® app on your mobile device.
2. Start the Home Connect® app and set up access for Home Connect®.

The Home Connect® app guides you through the entire registration process.

## 16.2 Setting up Home Connect®

### Requirements

- The Home Connect® app is installed on your mobile device.
- The appliance receives signals from the WLAN home network (Wi-Fi) at its installation location.

1. Press and hold **Remote Start** for around 3 seconds.
2. Follow the instructions in the Home Connect® app.

## 16.3 Activating Wi-Fi on the appliance

1. Press and hold **Remote Start** for around 3 seconds.
  2. Press **Remote Start** repeatedly until the display shows "oFF".
  3. Press **II ▷** to activate the Wi-Fi.
- ✓ The display shows "on".

### Notes

- If the Wi-Fi is activated, the display alternately shows "on" and the signal strength of the Wi-Fi connection.
- To exit the Home Connect® settings, press and hold **Remote Start** for approx. 3 seconds.

## 16.4 Deactivating Wi-Fi on the appliance

1. Press and hold **Remote Start** for around 3 seconds.
  2. Press **Remote Start** repeatedly until the display shows "on".
  3. Press **II ▷** to deactivate the Wi-Fi.
- ✓ The display shows "oFF".

**Note:** To exit the Home Connect® settings, press and hold **Remote Start** for approx. 3 seconds.

## 16.5 Installing a software update

**Note:** If a software update is available, a message appears in the Home Connect® app.

- ▶ To install the software update, follow the instructions in the Home Connect® app.
- ✓ The control panel is partially locked during the installation.

- ✓ In the event of a malfunction, installation may take up to 40 minutes. Do not reset the network settings or the appliance to the factory settings.

## 16.6 Resetting the appliance network settings

1. Press and hold **Remote Start** for around 3 seconds.
  2. Press **Remote Start** repeatedly until the display shows "rES".
  3. Press and hold **II ▷** for around 3 seconds.
- ✓ The network settings are reset.

## 16.7 Remote start

Enable the appliance for remote start via the Home Connect® app.

### Note

Remote start will be deactivated in the following circumstances:

- The appliance door is opened.
- Press **Remote Start**.
- Following a power failure.

### Activating remote start

#### Requirements

- The appliance door is closed.
- The detergent drawer has been pushed in.
- ▶ Press **Remote Start**.
- ✓  lights up and the appliance is enabled for remote start via the Home Connect® app.

### Deactivating remote start

- ▶ Press **Remote Start**.
- ✓  goes out.

## 16.8 Remote diagnostics

The Customer Service can access your appliance via Remote Diagnostics if you ask them to do so, if your appliance is connected to the Home Connect® server and if Remote Diagnostics is available in the country where you are using the appliance.

**Tip:** Further information and details about the availability of Remote Diagnostics in your country can be found in the Service/Support section of your local website: [www.home-connect.com](http://www.home-connect.com).

## 16.9 Data Protection

Please see the information on data protection.

The first time your appliance is registered on a home network connected to the Internet, your appliance will transmit the following types of data to the Home Connect® server (initial registration):

- Unique appliance identification (consisting of appliance codes as well as the MAC address of the installed Wi-Fi communication module).

- Security certificate of the Wi-Fi communication module (to ensure a secure data connection).
- The current software and hardware version of your appliance.
- Status of any previous reset to factory settings.

This initial registration prepares the Home Connect® functions for use and is only required when you want to use the Home Connect® functions for the first time.

**Note:** Please note that the Home Connect® functions can be utilized only with the Home Connect® app. Information on data protection can be called up in the Home Connect® app.

## 17 Basic settings

You can configure the basic settings for your appliance to meet your needs.

**Note:** You can also adjust the basic settings in the Home Connect® app.

### 17.1 Overview of the basic settings

**Note:** Additional functions may be available as a result of software updates.

→ "Installing a software update", Page 29

If a software update is available, you can find further information in the Home Connect® app.

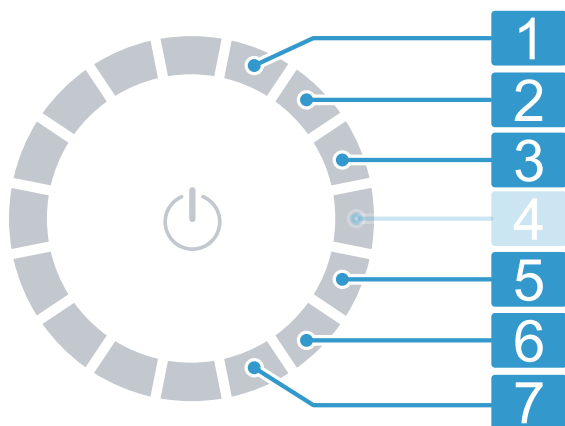

Program selector with program positions

1	Set the volume of the signal tone that is emitted when the program ends: 0 (off) to 4 (very loud)
2	Set the volume of the signal tone that is emitted when the buttons are selected: 0 (off) to 4 (very loud)
3	Set the display brightness: 1 (low) to 4 (very high)
5	Activate (on) or deactivate (oFF) the reminder to clean the drum.
6	Display the number of finished programs (PC).

## 7 Restore the appliance to the factory settings (rES).

### 17.2 Changing the basic settings

**Requirement:** The display shows all additional buttons.  
→ Page 17

1. To call up the basic settings, press **Basic Settings** .
2. Use the program selector to select the required basic setting. → Page 30
3. Adjust the basic setting:
  - To change the value, press ^ or v.
  - To reset the appliance to the factory settings, press and hold ||▶ for approx. 3 seconds.
4. To exit the basic settings, press **Basic Settings** .

## 18 Cleaning and maintenance

To keep your appliance working efficiently for a long time, it is important to clean and maintain it carefully.

### 18.1 Cleaning the drum

Clean the drum if you have carried out 20 washing cycles at a temperature of Hot or lower, if ☺ flashes, or if you have not used the appliance for a prolonged period, but at least once a year.

#### ⚠ CAUTION

Permanently washing at low temperatures and a lack of ventilation for the appliance may damage the drum and cause injury.

- ▶ Regularly run a program for cleaning the drum or wash at temperatures of Extra Hot.
- ▶ Leave the appliance to dry after every operation with the door open, and leave the detergent drawer to dry.
- ▶ Run the **Drum Clean** program without laundry but with washing powder that contains oxygen bleach or a cleaning agent for caring for the inside of the appliance.

### 18.2 Cleaning the detergent drawer

If you want to replace the liquid detergent or fabric softener in the dispenser with another product or if the detergent drawer is dirty, clean the detergent dispenser.

#### **NOTICE:**

The pump unit contains electrical components. Electrical components may be damaged if they come into contact with liquids.

- ▶ Do not clean the pump unit in the dishwasher and do not immerse it in water.
- ▶ Protect the electrical connection on the rear against water, detergent and fabric softener residue.

1. Put the appliance into standby mode. → Page 27
2. Pull out the detergent drawer.

3. Press down on the insert and remove the detergent drawer.

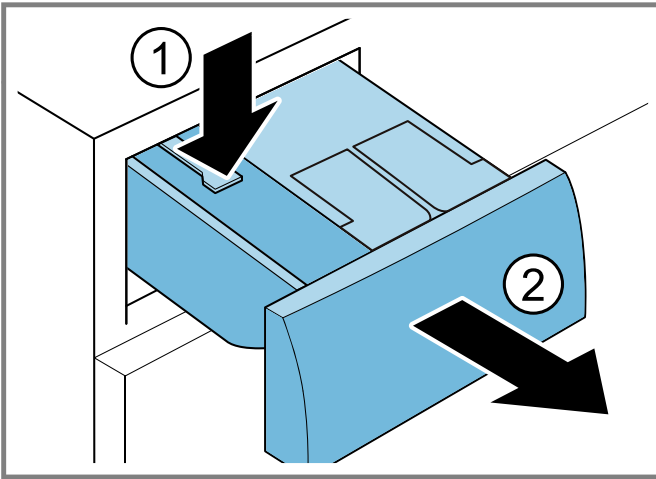

4. Remove the pump unit.

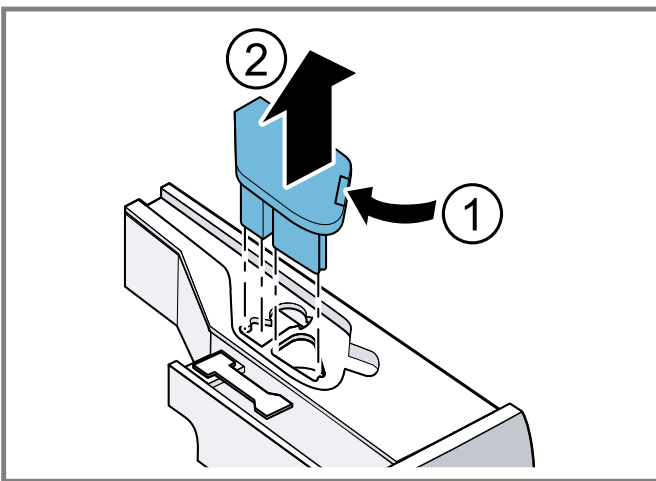

5. Unclip the detergent drawer cover and remove it.

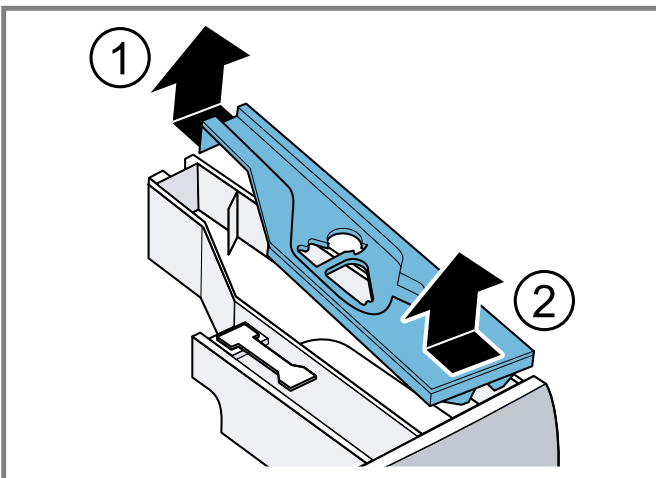

6. Empty the detergent drawer.

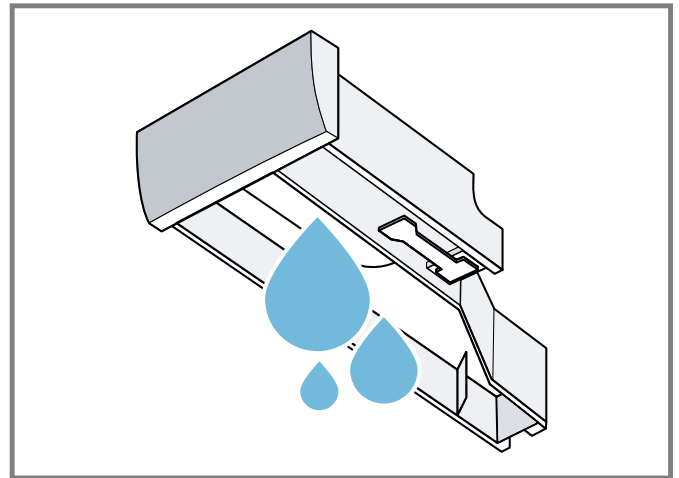

7. Clean the pump unit with a damp cloth.

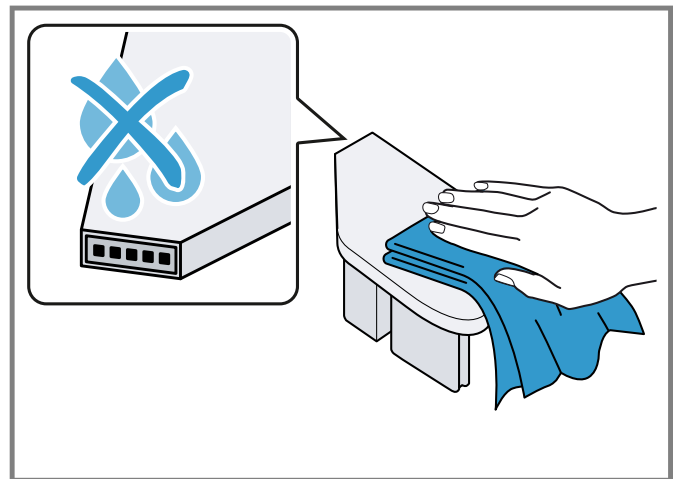

8. Clean the detergent drawer and the cover with a soft, damp cloth or hand shower.

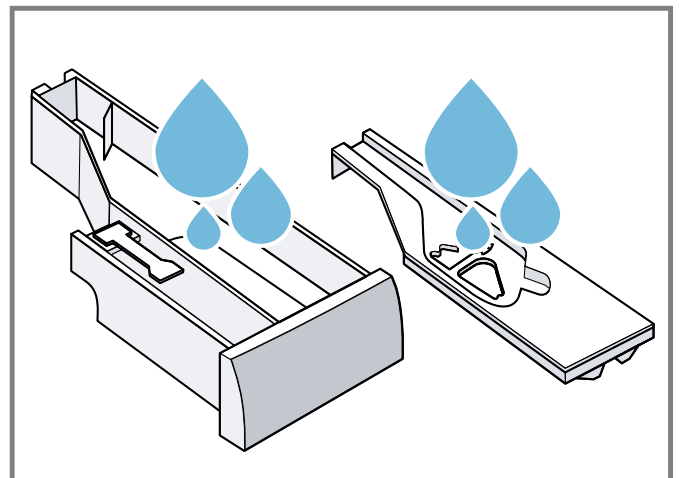

9. Dry the detergent drawer, cover and pump unit and reinsert them.

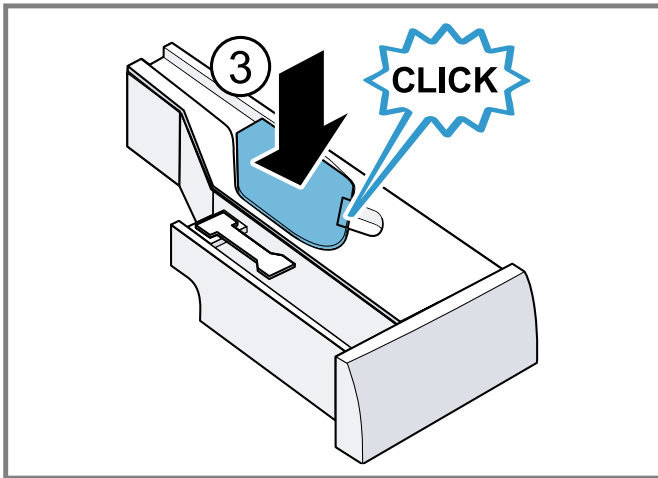
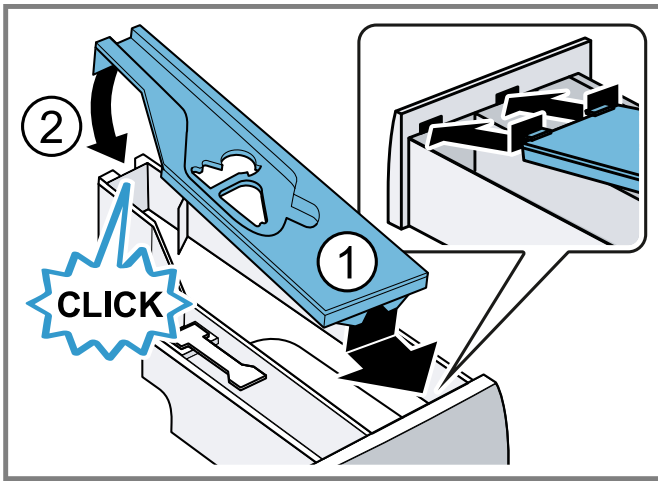

10. Clean the housing of the detergent drawer in the appliance.

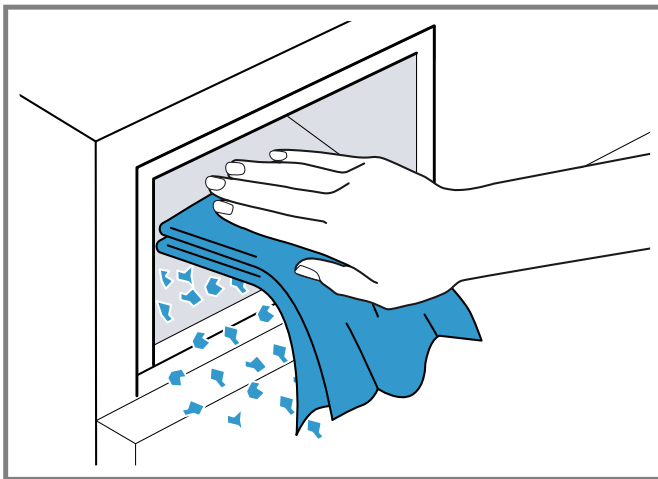

11. Push in the detergent drawer.



### 18.3 Cleaning the drain pump

Clean the drain pump regularly, at least once a year, as well as in the event of faults, e.g. blockages or rattling noises.

#### Emptying the drain pump

1. Turn off the faucet.
2. Put the appliance into standby mode. → *Page 27*
3. Disconnect the appliance's mains plug from the power supply.
4. Open and remove the service flap.

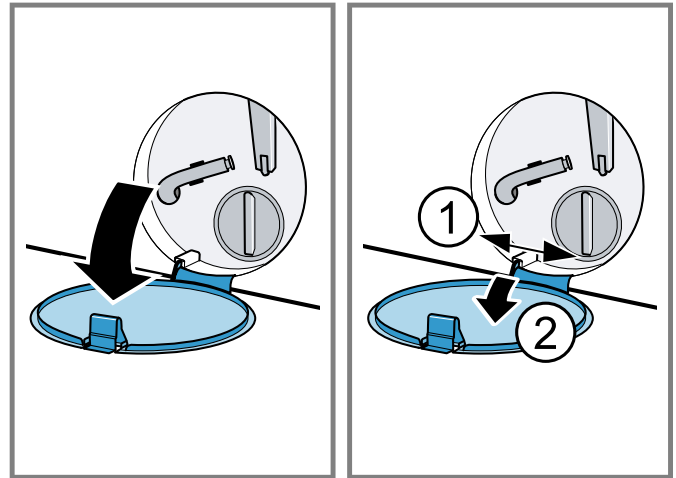

5. Loosen the screws and remove the protective film.

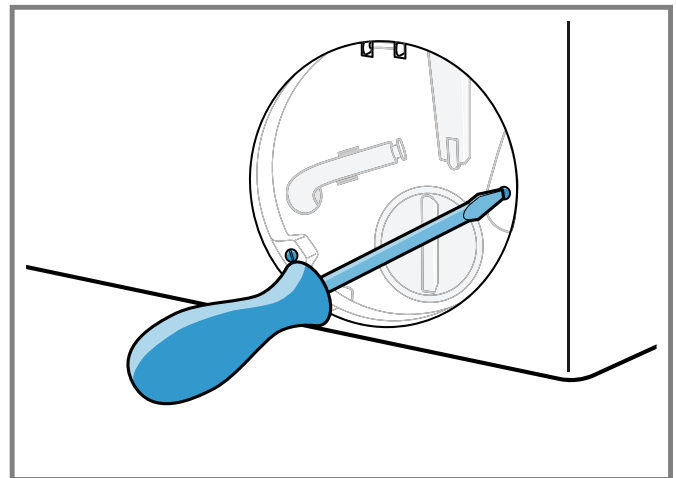



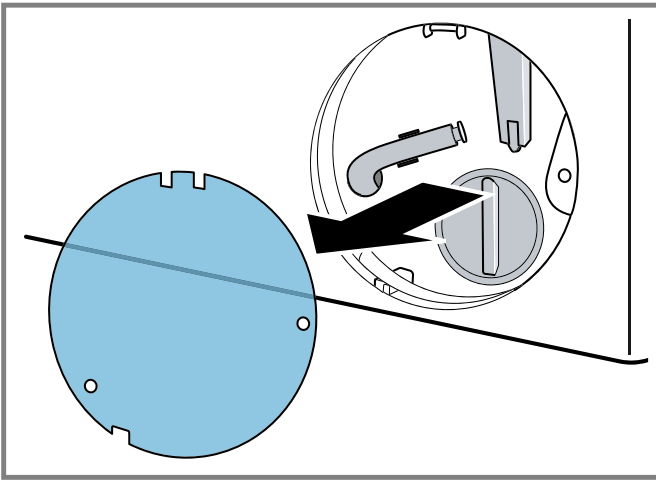

6. Slide a suitable receptacle under the opening for draining the detergent solution.

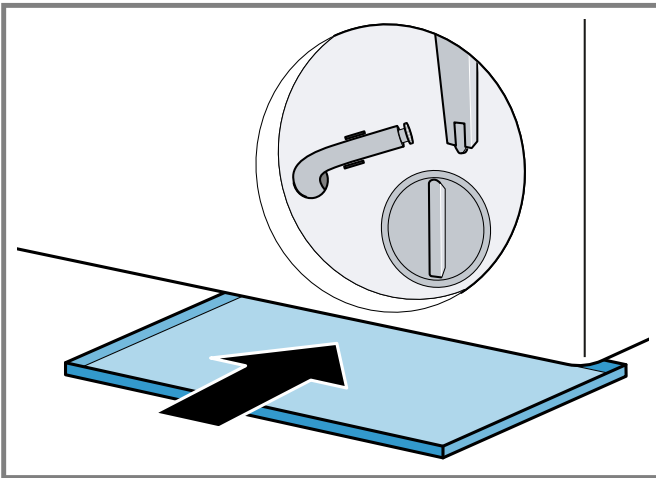

7. Take the drain hose out of the holder.

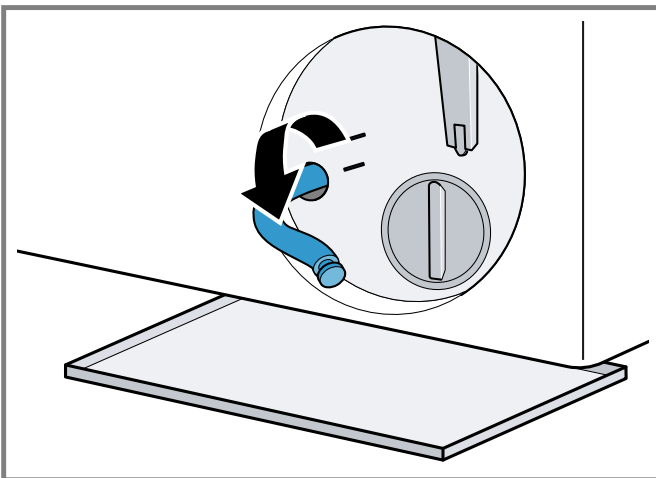

8. **⚠ CAUTION** When you wash at high temperatures, the detergent solution becomes hot.  
 ▶ Do not touch the hot detergent solution.  
 To allow the detergent solution to flow out into the container, remove the sealing cap.

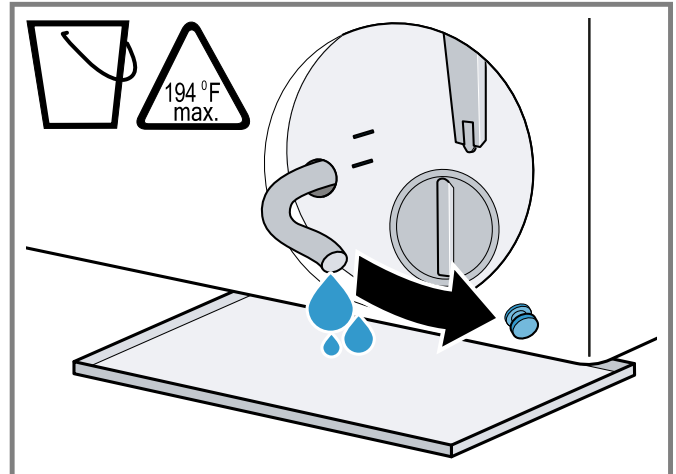

9. Once emptied, press firmly on the locking cap.

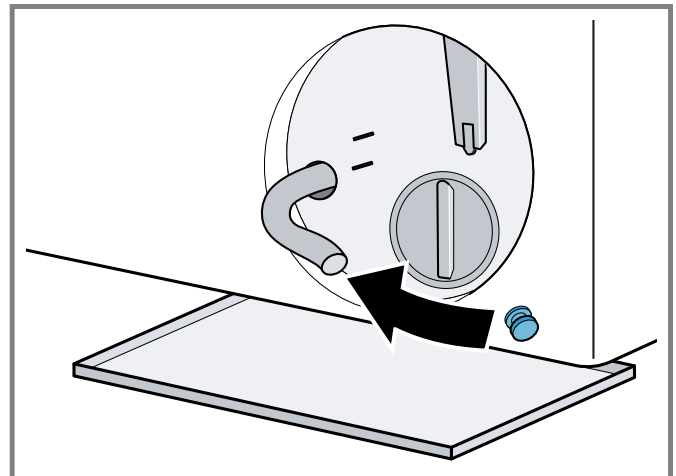

10. Clip the drain hose into the holder.

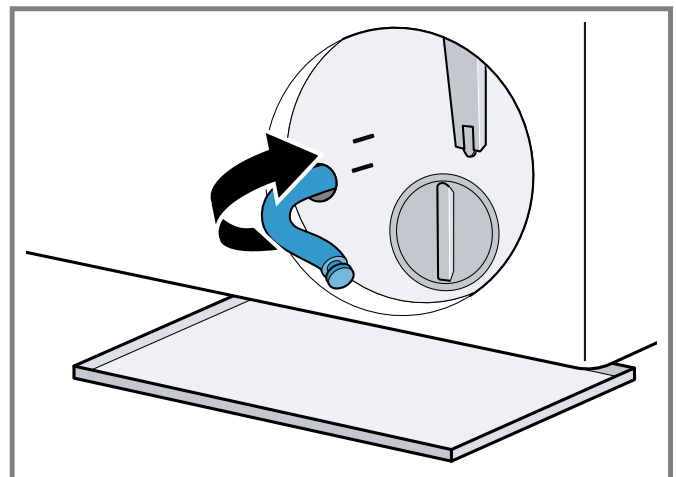

### Cleaning the drain pump

**Requirement:** The drain pump is empty. → Page 32

1. Since water may remain in the drain pump, unscrew the pump cap carefully.
  - The filter insert in the pump housing may become stuck due to coarse particles of dirt. Loosen the dirt and remove the filter insert.

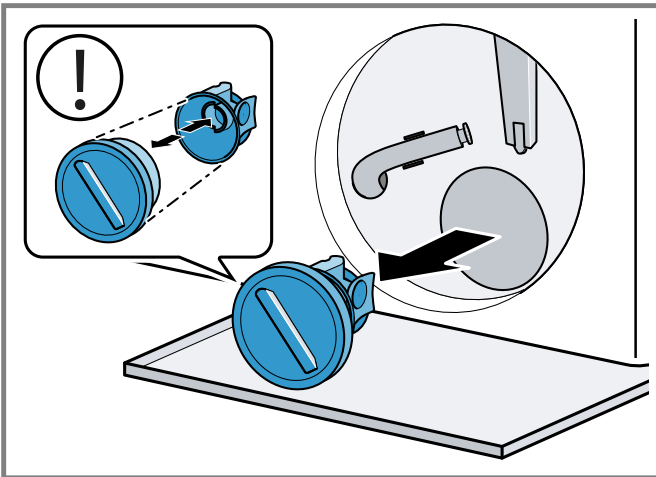

The pump cap is comprised of two parts which can be taken apart for cleaning.

2. Clean the interior, the thread on the pump cap and the pump housing.

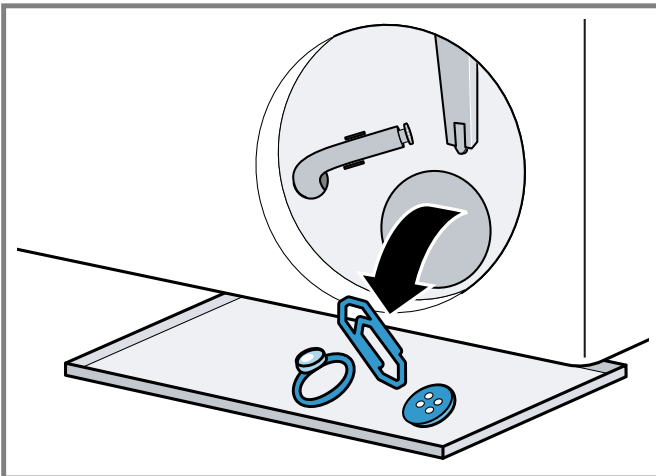

3. Ensure that both impellers can turn.

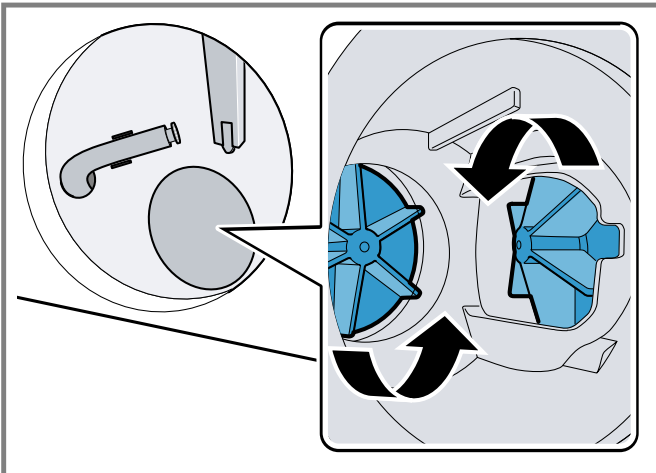

4. Insert the pump cap.
  - Ensure that the parts of the pump cap are correctly assembled.

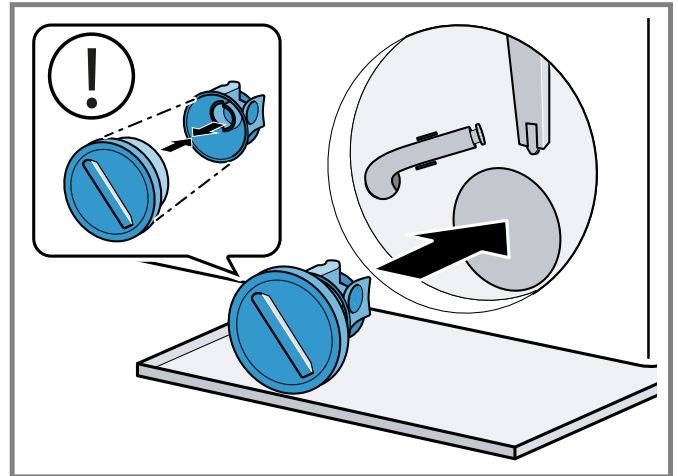

5. Screw the pump cap as far as it will go.

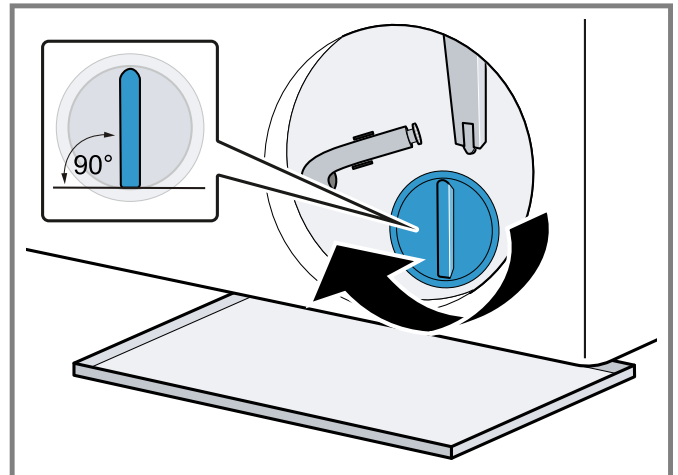

The handle on the pump cap must be in a vertical position.

6. Fit the protective film and secure with the screws.

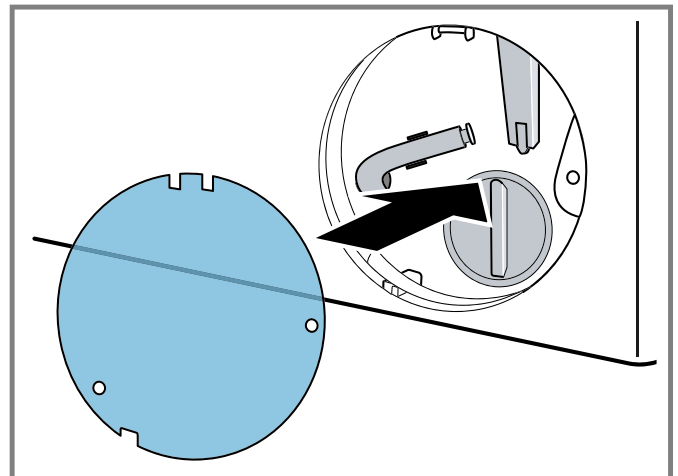

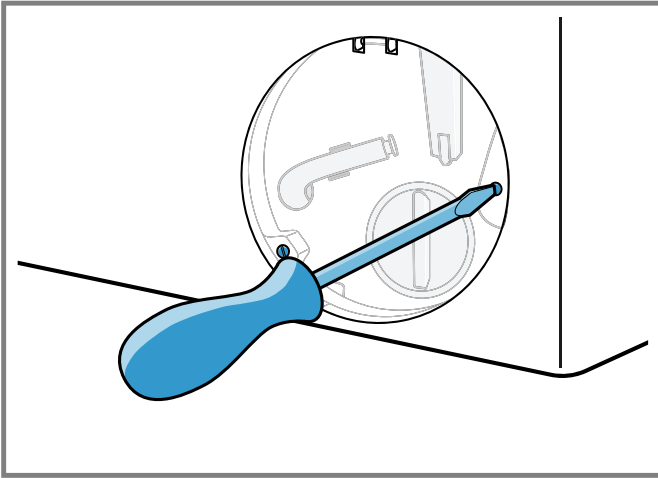

7. Insert and close the service flap.

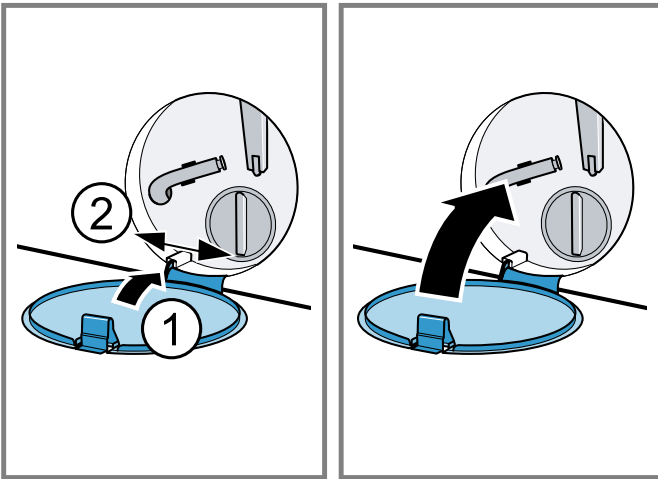

2. Remove any blockages from the inlet opening.

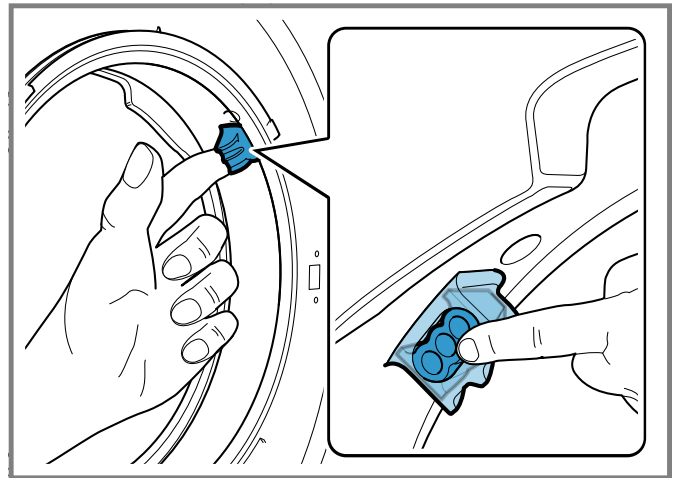

**Note:** Do not use any sharp or pointed objects.



#### 18.4 Cleaning the inlet opening in the rubber gasket

Regularly check the inlet opening in the rubber gasket for any blockages and clean the inlet opening.

1. Open the appliance door.

## 19 Troubleshooting

You can eliminate minor issues on your appliance yourself. Please read the information on eliminating issues before contacting Customer Service. This may avoid unnecessary repair costs.







**⚠ WARNING**

Improper repairs are dangerous.

- ▶ Never make any technical modifications to the appliance or its features.

- ▶ Do not tamper with controls.
- ▶ Repairs to the appliance should only be performed by authorized service providers.
- ▶ Only original spare parts may be used to repair the appliance.
- ▶ If the power cord of this appliance becomes damaged, it must be replaced by the manufacturer, the manufacturer's Customer Service, or an authorized service provider in order to prevent injury.

Issue	Cause and troubleshooting
The display goes out and II ▶ flashes.	Energy-saving mode is active. ▶ Press II ▶.
E:36 -10 / E:30 -80 The detergent solution is not being pumped out.	<p>The water outlet hose is connected too high, is kinked or trapped, or has been extended impermissibly. ▶ Check the installation of the water outlet hose. → <i>Page 12</i></p> <hr/> <p>Drain pipe or water outlet hose is blocked. ▶ Clean the drain pipe and the water outlet hose.</p> <hr/> <p>The drain pump is blocked or the pump cover is not installed correctly. ▶ Check that the pump cover is installed correctly. → <i>Page 32</i> ▶ Clean the drain pump. → <i>Page 32</i></p> <hr/> <p>Detergent dosage is too high. ▶ If intelligent dosing is activated, reduce the basic dosage. → <i>Page 28</i> ▶ If you dose manually, reduce the amount of detergent for the next washing cycle with the same load.</p>
E:36 -25 -26	Drain pump is blocked. ▶ Clean the drain pump. → <i>Page 32</i>
E:38 -25 -26	<p>Drain pump is blocked. 1. Clean the drum. → <i>Page 30</i> 2. If the fault persists, clean the drain pump. → <i>Page 32</i></p> <hr/> <p>Inlet opening of the rubber gasket is blocked. ▶ Clean the inlet opening in the rubber gasket. → <i>Page 35</i></p>
E:10 -00 -10 -20	<p>The pump for the intelligent dosing system is blocked. 1. Clean the detergent drawer. → <i>Page 30</i> 2. If the fault persists, call customer service. → <i>Page 40</i></p> <p><b>Note:</b> Until the fault is rectified, you can deactivate the intelligent dosing system and dose manually. → <i>Page 20</i></p>
H:32	<p>The appliance has interrupted the spin cycle because the laundry is unevenly distributed. ▶ Redistribute the laundry in the drum.</p>
E:30 -10 / E:92 -01 / 	<p>Faucet is turned off. ▶ Turn on the faucet.</p> <hr/> <p>The water inlet hose is kinked or jammed. ▶ Check the installation of the water inlet hose. → <i>Page 12</i></p> <hr/> <p>The filters in the water inlet are blocked. ▶ Clean the filters in the water inflow.</p> <hr/> <p>The water pressure is low. ▶ Check whether the faucet has sufficient water pressure.</p>

Issue	Cause and troubleshooting
E:30 -10 / E:92 -01 / 	<p>The water level measuring system is defective. With this fault message, the appliance starts a draining process.</p> <ol style="list-style-type: none"> <li>1. Wait approx. 5 minutes until the draining process ends.</li> <li>2. Restart the appliance. If required, start the draining process again.</li> <li>3. If the fault persists, call customer service. → <i>Page 40</i></li> </ol>
E:30 -20	<p>Critical malfunction.</p> <ul style="list-style-type: none"> <li>▶ Turn off the faucet.</li> </ul> <p>With this fault message, the appliance starts a draining process.</p> <ol style="list-style-type: none"> <li>1. Wait approx. 5 minutes until the draining process ends.</li> <li>2. Restart the appliance. If required, start the draining process again.</li> <li>3. If the fault persists, call customer service. → <i>Page 40</i></li> </ol>
	<p>Detergent dosage is too high.</p> <ul style="list-style-type: none"> <li>▶ If you dose manually, reduce the amount of detergent for the next washing cycle with the same load.</li> </ul>
	<p>Additional water has been added.</p> <ul style="list-style-type: none"> <li>▶ Do not add any extra water to the appliance while it is operating.</li> </ul>
All other fault codes.	<p>Operational fault</p> <ol style="list-style-type: none"> <li>1. To restart the appliance, press and hold  for approximately 5 seconds.</li> <li>2. If the fault occurs again, disconnect the appliance from the power supply for at least 30 seconds. Unplug the power plug or switch off the circuit breaker in the fuse box.</li> <li>3. If the fault persists, call customer service. → <i>Page 40</i> Please specify the exact error message when calling. If possible, document the fault with photos and videos.</li> </ol>
	<p>The detergent drawer has not been pushed in fully.</p> <ul style="list-style-type: none"> <li>▶ Push in the detergent drawer.</li> </ul>
	<p>The pump unit is not inserted correctly.</p> <ul style="list-style-type: none"> <li>▶ Check that the pump unit is inserted correctly. → <i>Page 30</i></li> </ul>
 or heavy foam build-up.	<p>Detergent dosage is too high.</p> <ul style="list-style-type: none"> <li>▶ Mix one tablespoon of fabric softener with 2.1 cups (0.5 l) of water and pour the mixture into the compartment for manual dosing (not for outdoor clothing, sportswear, or items stuffed with down).</li> <li>▶ If intelligent dosing is activated, reduce the basic dosage. → <i>Page 28</i></li> <li>▶ If you dose manually, reduce the amount of detergent for the next washing cycle with the same load.</li> </ul>
	<p>Drum cleaning is required.</p> <ul style="list-style-type: none"> <li>▶ Clean the drum. → <i>Page 30</i></li> </ul>
The display and buttons do not respond.	<p>Software fault.</p> <ol style="list-style-type: none"> <li>1. To restart the appliance, press and hold  for approximately 5 seconds.</li> <li>2. If the fault occurs again, disconnect the appliance from the power supply for at least 30 seconds. Unplug the power plug or switch off the circuit breaker in the fuse box.</li> </ol>
Home Connect® is not working properly.	<p>Various causes are possible.</p> <ol style="list-style-type: none"> <li>1. Reset the appliance network settings. → <i>Page 29</i></li> <li>2. Set up Home Connect® again. → <i>Page 29</i> ▶ Go to <a href="http://www.home-connect.com">www.home-connect.com</a>.</li> </ol>

Issue	Cause and troubleshooting
i-DOS 1/i-DOS 2 cannot be pressed.	The selected program or program progress does not allow intelligent dosing. ▶ Use the manual dosing compartment. → <i>Page 28</i>
The program does not start.	The control panel lock is activated. ▶ Deactivate the control panel lock. → <i>Page 27</i>
	<b>Finish in</b> is activated. ▶ Check whether <b>Finish in</b> is activated. → <i>Page 20</i>
	The detergent drawer has not been pushed in fully. ▶ Push in the detergent drawer.
The program is paused or has been interrupted, but the door will not open.	Temperature is too high. ▶ Start the <b>Rinse</b> program or wait until the temperature has dropped.
	Water level is too high. ▶ Start the <b>Spin</b> program or a suitable draining program. → <i>Page 22</i>
The door cannot be opened due to a power outage.	The door is locked. ▶ Open the door using the emergency release. → <i>Page 39</i>
Drum jerks after the program starts.	Not a fault. An internal motor test is started. No action required.
Drum rotates, water does not flow in.	Not a fault. Load detection is active for up to 2 minutes. No action required.
There is no water visible in the drum.	Not a fault. Water is below the visible area. No action required.
Drum starts rotating briefly several times.	Not a fault. The appliance eliminates an imbalance by repeatedly redistributing the laundry. No action required.
The appliance is vibrating, 'wandering', and making loud noises during the spin cycle.	Appliance is not correctly aligned. ▶ Align the appliance. → <i>Page 13</i>  The appliance feet are not fixed. ▶ Secure the appliance's feet. → <i>Page 13</i>  Transit bolts have not been removed. ▶ Remove the transit bolts. → <i>Page 11</i>
High spin speed not reached.	The appliance is using a reduced spin speed to eliminate an imbalance. No action required.
The program duration changes during the wash cycle.	Not a fault. The program sequence is optimized electronically, another rinse cycle is switched on due to heavy foam build-up, or an imbalance is eliminated. No action required.
Whooshing, hissing, whirring, or sucking noises.	Not a fault. Water is pumped in, detergent and fabric softener is dosed, function tests are performed, or detergent solution is pumped out. No action required.
Banging noises, rattling in the drain pump.	A foreign object is in the drain pump. ▶ Clean the drain pump. → <i>Page 32</i>
Insufficient cleaning or detergent residues on the laundry.	Detergents may contain water-insoluble substances that deposit on the laundry. ▶ Start the <b>Rinse</b> program or brush out the laundry after drying.  The detergent in the dispenser is unsuitable or thickened. 1. Check whether the detergent is suitable. → <i>Page 25</i> 2. Check whether the detergent in the dispenser has thickened. 3. If the detergent is unsuitable or has thickened, empty it out and clean the dispenser. → <i>Page 30</i>  The basic dosage is not correctly adjusted. ▶ Set the basic dosage. → <i>Page 28</i>

Issue	Cause and troubleshooting
The laundry is too wet after the spinning cycle.	<p>A low spin speed is selected.</p> <ul style="list-style-type: none"> <li>▶ Start the <b>Spin</b> program.</li> <li>▶ The next time you run a wash cycle, set a higher spin speed.</li> </ul> <hr/> <p>The appliance is using a reduced spin speed to eliminate an imbalance.</p> <ol style="list-style-type: none"> <li>1. Redistribute the laundry in the drum.</li> <li>2. Start the <b>Spin</b> program.</li> </ol>
Creasing.	<p>The selected program is unsuitable for the type of fabric.</p> <ul style="list-style-type: none"> <li>▶ Set a suitable program. → <i>Page 22</i></li> </ul> <hr/> <p>A high spin speed is selected.</p> <ul style="list-style-type: none"> <li>▶ The next time you run a wash cycle, set a lower spin speed.</li> </ul> <hr/> <p>The load is unsuitable.</p> <ul style="list-style-type: none"> <li>▶ Observe the program's maximum load capacity. → <i>Page 22</i></li> <li>▶ Prepare the laundry. → <i>Page 25</i></li> </ul>
Water is leaking out at the water inlet hose.	<p>The water inlet hose is not correctly connected or is damaged.</p> <ul style="list-style-type: none"> <li>▶ Check the installation of the water inlet hose. → <i>Page 9</i></li> </ul> <p>Replace the water inlet hose if it is damaged.</p>
Water is leaking out at the water outlet hose.	<p>The water outlet hose is not connected correctly or is damaged.</p> <ul style="list-style-type: none"> <li>▶ Check the installation of the water outlet hose. → <i>Page 9</i></li> </ul> <p>Replace the water outlet hose if it is damaged.</p>
Water is leaking from below the door.	<p>Dirt on the door or seal causes leaks.</p> <ul style="list-style-type: none"> <li>▶ Clean the door and the seal.</li> </ul>
Odors have formed in the appliance.	<p>Humidity and detergent residue may promote the formation of bacteria.</p> <ul style="list-style-type: none"> <li>▶ Clean the drum. → <i>Page 30</i></li> <li>▶ If you are not using the appliance, leave the door and detergent drawer open so that residual water can evaporate.</li> </ul>

## 19.1 Emergency release

### Releasing the door

**Requirement:** The drain pump is empty. → *Page 32*

1. **NOTICE:** Escaping water may cause material damage.
  - ▶ Do not open the door if you can see water through the glass.

Pull the emergency release downwards with a tool and release.

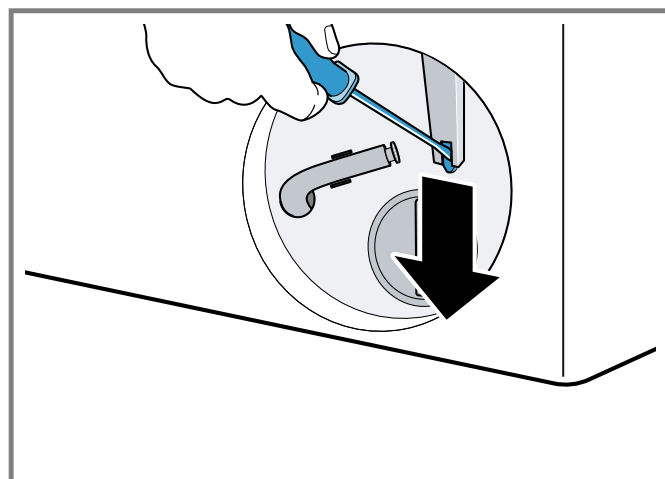

- ✓ The door lock is released.

2. Insert the service flap and lock it into place.
3. Close the service flap.

---

## 20 Transportation, storage and disposal

### 20.1 Removing the appliance

1. Turn off the faucet.
2. Empty the water inlet hose.
3. Put the appliance into standby mode. → *Page 27*
4. Unplug the appliance's mains plug.
5. Drain the water.  
→ *"Cleaning the drain pump", Page 32*
6. Detach the hoses.
7. Empty the dispensers.

### 20.2 Inserting the transit bolts

Secure the appliance before transportation using transit bolts in order to prevent transport damage.

1. Use a screwdriver to remove the 4 cover caps.

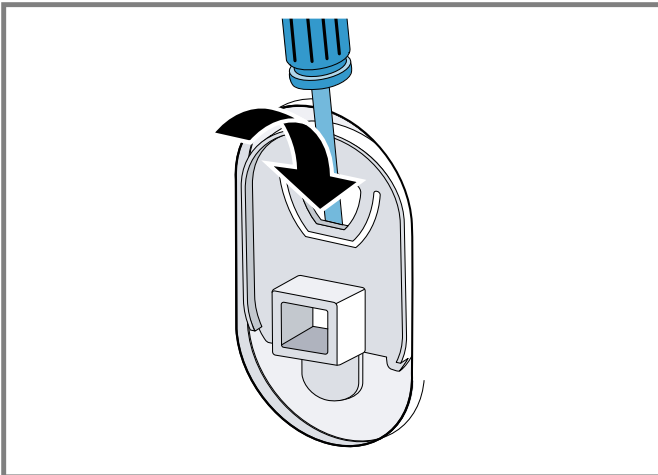

Keep the cover caps.

2. Insert the 4 transit bolts.  
→ *"Removing the transit bolts", Page 11*

### 20.3 Using the appliance again

- ▶ For further information, see  
→ *"Installation and connection", Page 9* and  
→ *"Starting an empty washing cycle", Page 14.*

## 20.4 Disposal of your old appliance

Environmentally compatible disposal allows valuable raw materials to be recycled.

### ⚠ WARNING

Children can lock themselves in the appliance, thereby putting their lives at risk.

- ▶ Do not install the appliance behind a door as this may obstruct the appliance door or prevent it from opening.
- ▶ With redundant appliances, pull out the mains plug of the power cord, cut through the power cord and remove the appliance door.

1. Unplug the appliance from the power supply.
2. Cut through the power cord.
3. Remove the appliance door.
4. Dispose of the appliance in an environmentally responsible manner.

Information about current disposal methods can be obtained from your specialist dealer or local authority.

---

## 21 Customer Service

With any warranty repair, we will make sure your appliance is repaired by an authorized service provider using genuine replacement parts. We use only genuine replacement parts for all repairs.

Detailed information on the warranty period and terms of warranty can be found in the Statement of Limited Product Warranty, from your retailer, or on our website.

If you contact Customer Service, you will need the model number (E-Nr.), the production number (FD) and the consecutive numbering (Z-Nr.) of your appliance.

USA:

1-800-944-2904

[www.bosch-home.com/us/owner-support/get-support](http://www.bosch-home.com/us/owner-support/get-support)

[www.bosch-home.com/us/shop](http://www.bosch-home.com/us/shop)

CA:

1-800-944-2904

[www.bosch-home.ca/en/service/get-support](http://www.bosch-home.ca/en/service/get-support)

[www.bosch-home.ca/en/service/cleaners-and-accessories](http://www.bosch-home.ca/en/service/cleaners-and-accessories)

For assistance with connecting to Home Connect®, you can also view instructions here:

[www.home-connect.com/us/en/help-support/set-up](http://www.home-connect.com/us/en/help-support/set-up)

### 21.1 Model number (E-Nr.), production number (FD) and consecutive numbering (Z-Nr.)

You can find the model number (E-Nr.), the production number (FD) and the consecutive numbering (Z-Nr.) on the appliance's rating plate.

Depending on the model, the rating plate can be found:

- on the inside of the door.
- on the inside of the service flap.
- on the backside of the appliance.



Making a note of your appliance's details and the Customer Service telephone number will enable you to find them again quickly.

## 22 Technical specifications

Weight	106.9 lbs (82.6 kg)
Drum volume	2.4 ft <sup>3</sup>
Mains voltage	208-240 V, 60 Hz
⇒ Minimum installation protection	10,5 A
Power rating	2300 W
Water pressure	<ul style="list-style-type: none"> <li>■ Minimum: 14.5 psi (100 kPa)</li> <li>■ Maximum: 145 psi (1000 kPa)</li> </ul>
Ambient temperature	<ul style="list-style-type: none"> <li>■ Minimum: 41 °F (5 °C)</li> <li>■ Maximum: 95 °F (35 °C)</li> </ul>
Relative humidity	< 95 %
Length of the water inlet hose	47" (119.4 cm)
Length of the water drain hose	57" (144.8 cm)
Length of the power cord	64 <sup>7</sup> / <sub>8</sub> " (165 cm)

### Appliance dimensions

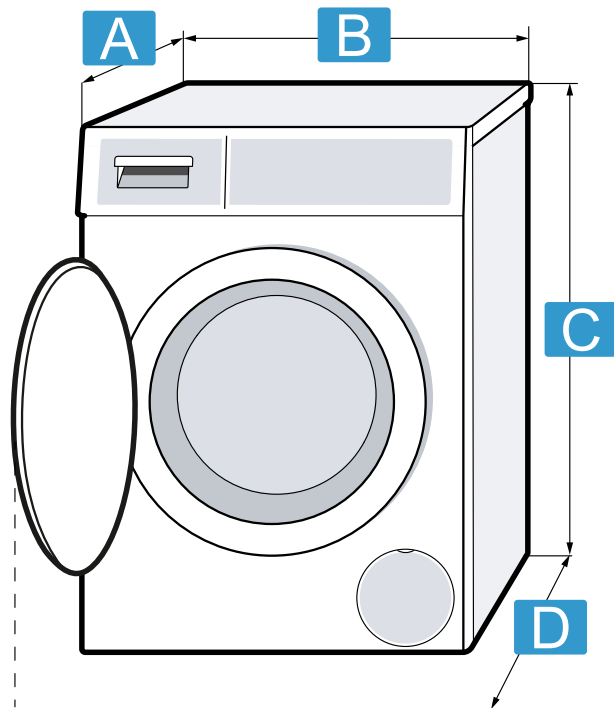

- A** Appliance depth: 23 1/4" (59.0 cm)  
 Appliance depth with door closed: 25 1/2" (64.8 cm)

- B** Appliance width: 23 1/2" (59.8 cm)
- C** Appliance height<sup>1</sup>: 33 1/4" (84.5 cm)
- D** Appliance depth with door open: 43" (109.0 cm)

<sup>1</sup> When aligning the appliance, the appliance height may increase by up to 1/2" (1.2 cm).

### 22.1 Information regarding Free and Open Source Software

This product includes software components that are licensed by the copyright holders as free or open source software.

The applicable license information is stored on your home appliance. You can also access the applicable license information via your Home Connect® app: "Profile -> Legal information -> License Information".<sup>1</sup> You can download the license information on the brand product website. (Please search on the product website for your appliance model and additional documents). Alternatively, you can request the relevant information from [ossrequest@bshg.com](mailto:ossrequest@bshg.com) or BSH Hausgeräte GmbH, Carl-Wery-Str. 34, 81739 Munich, Germany.

The source code will be made available to you on request. Please send your request to [ossrequest@bshg.com](mailto:ossrequest@bshg.com) or BSH Hausgeräte GmbH, Carl-Wery-Str.34, 81739 Munich, Germany.

Subject: „OSSREQUEST“

The cost of performing your request will be charged to you. This offer is valid for three years from the date of purchase or at least as long as we offer support and spare parts for the relevant appliance.

<sup>1</sup> When aligning the appliance, the appliance height may increase by up to 1/2" (1.2 cm).

<sup>1</sup> Depending on the appliance specifications



A series of horizontal lines for writing, starting from the top of the page and extending to the bottom.



A series of horizontal lines for writing, starting from the top right of the pencil icon and extending across the page.



## Register your appliance to enjoy customized benefits.

Thank you for being a Bosch customer!  
Simply create a MyBosch account, then register your appliance.  
You'll find a variety of customized information in MyBosch such as:

- **Discounts for filters, cleaners, accessories & parts**
- **Easy access to manuals & appliance specifications**
- **Easy access to part lists**
- **Customized offer for the Bosch Appliance Service Plan (sent by mail after appliance registration)**

Register here:  
[www.bosch-home.com/us/owner-support/mybosch](http://www.bosch-home.com/us/owner-support/mybosch)

**BOSCH**  
HOME APPLIANCES  
**SERVICE**

## Looking for help? You'll find it here.

No matter what, no matter when: Bosch is here to support you.  
We're here to assist with usage instructions, cleaning tips,  
accessories & parts, troubleshooting, and repairs.  
Find online resources such as FAQs, how-to-videos, manuals,  
warranties and authorized Bosch servicers at:  
[www.bosch-home.com/us/owner-support/get-support](http://www.bosch-home.com/us/owner-support/get-support)

Contact us:  
**Please have your Model Number (E-Nr) ready when contacting us.**  
1-800-944-2904  
[www.bosch-home.com/us/owner-support/contact-us](http://www.bosch-home.com/us/owner-support/contact-us)

**BSH Home Appliances Corporation**  
1901 Main Street, Suite 600  
Irvine, CA 92614  
USA  
[www.bosch-home.com](http://www.bosch-home.com)  
1-800-944-2904  
© 2024 BSH Home Appliances Corporation



**9001853079** (041022)

en-us