



BOSCH

Register your
appliance and join
the Bosch
family of perks:
[bosch-home.com/us/
mybosch](https://bosch-home.com/us/mybosch)



Washing machine

WGB246AXUC

[en-us] User manual and installation
instructions

Further information and explanations are available online:



Table of contents

1 Safety	4	13.6 Starting the program.....	25
1.1 Safety definitions.....	4	13.7 Soaking laundry	25
1.2 General information.....	4	13.8 Adding laundry	26
1.3 Intended use	4	13.9 Terminating the program	26
1.4 Restrictive Use.....	4	13.10 Removing the laundry	26
1.5 Safe installation.....	4	13.11 Put the appliance into standby mode.....	26
1.6 Safe use.....	5	14 Control panel lock	26
1.7 Safe cleaning and maintenance	6	14.1 Activating the control panel lock	26
1.8 State of California Proposition 65 Warnings	7	14.2 Deactivating the control panel lock.....	26
2 Preventing material damage	8	15 Intelligent dosing system	26
3 Environmental protection and energy-saving	8	15.1 Pouring liquid detergent and fabric softener into the dispensers.....	26
3.1 Disposal of packaging	8	15.2 Using the manual dosing compartment	27
3.2 Save energy and conserve resources	8	15.3 Adapting the \otimes/O dispenser.....	27
3.3 Energy-saving mode	9	15.4 Setting the basic dosage amount	27
4 Installation and connection	9	16 Home Connect®	27
4.1 Unpacking the appliance	9	16.1 Setting up the Home Connect® app	28
4.2 Included in delivery	9	16.2 Setting up Home Connect®.....	28
4.3 Requirements for the installation location.....	9	16.3 Home Connect® menu.....	28
4.4 Removing the transit bolts.....	10	16.4 Activating Wi-Fi on the appliance	28
4.5 Connecting the appliance.....	11	16.5 Deactivating Wi-Fi on the appliance	28
4.6 Aligning the appliance	12	16.6 Resetting the appliance network settings	28
5 Before using for the first time	12	16.7 Remote start.....	28
5.1 Starting an empty washing cycle	12	16.8 Remote diagnostics.....	28
6 Familiarizing yourself with your appliance	14	16.9 Data Protection	29
6.1 Appliance	14	17 Basic settings	29
6.2 Detergent drawer	14	17.1 Overview of the basic settings.....	29
6.3 Control panel.....	15	17.2 Changing the basic settings	29
6.4 Operating logic.....	15	18 Cleaning and maintenance	29
7 Display	17	18.1 Cleaning the drum	29
8 Buttons	19	18.2 Cleaning the detergent drawer	29
9 Programs	21	18.3 Cleaning the drain pump	31
10 Accessories	24	18.4 Cleaning the inlet opening in the rubber gasket.....	34
11 Laundry	24	19 Troubleshooting	35
11.1 Preparing the laundry	24	20 Transportation, storage and disposal	43
12 Detergents and care products	24	20.1 Removing the appliance	43
13 Basic Operation	24	20.2 Inserting the transit bolts	43
13.1 Switching on the appliance.....	24	20.3 Using the appliance again	43
13.2 Setting a program	24	20.4 Disposal of your old appliance.....	43
13.3 Changing the program settings	25	21 Customer Service	44
13.4 Saving the program settings.....	25	21.1 Model number (E-Nr.), production number (FD) and consecutive numbering (Z-Nr.)	44
13.5 Loading laundry	25		

22 Technical specifications..... 44



IMPORTANT SAFETY INSTRUCTIONS

READ AND SAVE THESE INSTRUCTIONS

Read all of the instructions carefully before using the appliance. In order to reduce the risk of fire, electric shocks and personal injuries when using the appliance, follow the basic safety precautions, including the following safety instructions.

1.1 Safety definitions

Here you can find explanations of the safety signal words used in this manual.

1.2 General information



- Read this manual carefully.
- Keep the manual and the product information in a safe place for future reference or for the next owner.
- Do not connect the appliance if it has been damaged in transit.

1.3 Intended use

Only a licensed professional may connect appliances without plugs. The manufacturer is not responsible for damage caused by incorrect connections. An incorrect connection is not covered by the Statement of Limited Product Warranty.

Only use this appliance:

- For washing machine-washable fabrics and hand-washable wool in accordance with the care label.
- With tap water and commercially available, washing-machine-suitable detergents and care products.
- for normal household use and in enclosed spaces in a residential environment.
- up to an altitude of max. 13,100 ft (4000 m) above sea level.

1.4 Restrictive Use

This appliance is not intended for use by persons (including children) with reduced physical, sensory or mental capabilities, or lack of experience and knowledge,

WARNING

This indicates that death or serious injuries may occur as a result of non-observance of this warning.

CAUTION

This indicates that minor or moderate injuries may occur as a result of non-observance of this warning.

NOTICE:

This indicates that damage to the appliance or property may occur as a result of non-compliance with this advisory.

Note: This alerts you to important information and/or tips.

unless they have been given supervision or instruction concerning use of the appliance by a person responsible for their safety.

Do not let children play with the appliance.

Cleaning and user maintenance must not be performed by children unless they are being supervised.

Keep children under the age of 3 and pets away from the appliance.

1.5 Safe installation

WARNING

Incorrect installation is dangerous.

- ▶ Connect and operate the appliance only in accordance with the specifications on the rating plate.
- ▶ Connect the appliance to a power supply with alternating current only via a correctly installed socket outlet with grounding.
- ▶ The protective conductor system of the domestic electrical installation must be properly installed. The installation must have a sufficiently large cable cross-section.
- ▶ When using a residual current circuit breaker, only use a type with the  mark.
- ▶ Never equip the appliance with an external switching device, e.g. a timer or remote control.



IMPORTANT SAFETY INSTRUCTIONS

READ AND SAVE THESE INSTRUCTIONS

- ▶ When the appliance is installed, the power plug of the power cord must be freely accessible. If free access is not possible, an all-pole isolating switch must be integrated in the permanent electrical installation according to the installation regulations.

- ▶ When installing the appliance, check that the power cord is not trapped or damaged.

If the insulation of the power cord is damaged, that can be dangerous.

- ▶ Never let the power cord come into contact with hot appliance parts or heat sources.
- ▶ Never let the power cord come into contact with sharp points or edges.
- ▶ Never kink, crush or modify the power cord.

WARNING

It is dangerous to use an extended power cord and non-approved adapters.

- ▶ Do not use extension cords or multiple socket strips.
- ▶ Only use adapters and power cords approved by the manufacturer.
- ▶ If the power cord is too short and a longer one is not available, please contact an electrician to have the domestic installation adapted.

WARNING

The heavy weight of the appliance may result in injury when lifted.

- ▶ Do not lift the appliance on your own.

If this appliance is not correctly installed in a washer-dryer stack, the installed appliance may fall.

- ▶ Only stack the dryer on a washing machine using the connection kit from the dryer manufacturer. No other installation method is permitted.
- ▶ Do not install the appliance in a washer-dryer stack if the dryer manufacturer does not offer a suitable connection kit.
- ▶ Do not install appliances from different manufacturers and with varying depths and widths in a washer-dryer stack.
- ▶ Do not install a washer-dryer stack on a platform; the appliances may tip over.

WARNING

Children may pull packaging material over their heads, or wrap themselves up in it and suffocate.

- ▶ Keep packaging material away from children.
- ▶ Do not allow children to play with packaging material.

CAUTION

The appliance may vibrate or move when in use.

- ▶ Place the appliance on a clean, even, solid surface.
- ▶ Align the appliance using the appliance feet and a spirit level.

If hoses and power cords have been laid incorrectly, this causes a tripping hazard.

- ▶ Lay hoses and power cords in such a way that there is no risk of tripping.

If the appliance is moved by holding onto protruding components, such as the appliance door, the parts may break off.

- ▶ Do not move the appliance by holding onto protruding parts.

CAUTION

Touching sharp edges on the appliance may lead to cuts.

- ▶ Do not touch the sharp edges on the appliance.
- ▶ Wear protective gloves when installing and transporting the appliance.

1.6 Safe use

WARNING

If the appliance or the power cord is damaged, this is dangerous.

- ▶ Never operate a damaged appliance.
 - ▶ Never pull on the power cord to unplug the appliance. Always unplug the appliance at the power outlet.
 - ▶ If the appliance or the power cord is damaged, immediately unplug the power cord or switch off the breaker in the circuit breaker box and turn off the water tap.
 - ▶ Call Customer Service. → *Page 44*
- Moisture intrusion may cause an electric shock.
- ▶ Use the appliance in enclosed spaces only.
 - ▶ Never expose the appliance to intense heat or humidity.
 - ▶ Do not use steam cleaners, high-pressure cleaners, hoses or sprays to clean the appliance.

WARNING

Children can lock themselves in the appliance, thereby putting their lives at risk.

- ▶ Do not install the appliance behind a door as this may obstruct the appliance door or prevent it from opening.
- ▶ With redundant appliances, pull out the mains plug of the power cord, cut through the power cord and remove the appliance door.



IMPORTANT SAFETY INSTRUCTIONS

READ AND SAVE THESE INSTRUCTIONS

When spinning larger, waterproof items of laundry, imbalances may arise and lead to injuries.

- ▶ Do not wash and spin larger items of laundry, such as blankets or mattress covers, in the appliance.

WARNING

Children may breathe in or swallow small parts, causing them to suffocate.

- ▶ Keep small parts away from children.
- ▶ Do not allow children to play with small parts.

WARNING

A hot-water system that has not been used for 2 weeks or more may produce flammable hydrogen gas.

- ▶ Before using the appliance open all hot-water faucets for a few minutes to release hydrogen gas.
- ▶ During these minutes, do not smoke or use an open flame.

WARNING

Detergents and care products may result in poisoning if consumed.

- ▶ If accidentally swallowed, seek medical advice.
- ▶ Keep detergents and care products out of the reach of children.

WARNING

Laundry that has been pretreated with flammable cleaning agents that contain solvents may cause an explosion in the appliance.

- ▶ Rinse pretreated laundry thoroughly with water before washing.

CAUTION

The covering plate may break if you stand on or climb onto the appliance.

- ▶ Do not stand on or climb onto the appliance.
- The appliance may tip over if you sit on or lean against the open door.
- ▶ Do not sit on or lean against the appliance door.
 - ▶ Do not place any objects on the appliance door.
- Reaching into the drum while it is still turning may cause hand injuries.
- ▶ Wait for the drum to come to a complete stop before reaching inside.

CAUTION

When you wash at high temperatures, the detergent solution becomes hot.

- ▶ Do not touch the hot detergent solution.

CAUTION

If the detergent drawer is opened, detergent and care products may spray out from the appliance. Contact with eyes or skin may cause irritation.

- ▶ Rinse eyes and/or skin thoroughly with clean water if they come into contact with detergents or care products.
- ▶ If accidentally swallowed, seek medical advice.
- ▶ Keep detergents and care products out of the reach of children.

1.7 Safe cleaning and maintenance

WARNING

Improper repairs are dangerous.

- ▶ Never make any technical modifications to the appliance or its features.
 - ▶ Do not tamper with controls.
 - ▶ Repairs to the appliance should only be performed by authorized service providers.
 - ▶ Only original spare parts may be used to repair the appliance.
 - ▶ If the power cord of this appliance becomes damaged, it must be replaced by the manufacturer, the manufacturer's Customer Service, or an authorized service provider in order to prevent injury.
- Moisture intrusion may cause an electric shock.
- ▶ Before cleaning, pull out the power plug or switch off the circuit breaker in the circuit breaker box.
 - ▶ Do not use steam cleaners, high-pressure cleaners, hoses or sprays to clean the appliance.

WARNING

The use of non-original spare parts and non-original accessories is dangerous.

- ▶ Only use the manufacturer's original spare parts and original accessories.

WARNING

Poisonous fumes may be given off if you use cleaning agents that contain solvents.

- ▶ Do not use cleaning agents that contain solvents.



IMPORTANT SAFETY INSTRUCTIONS

READ AND SAVE THESE INSTRUCTIONS

1.8 State of California Proposition 65 Warnings

This product may contain a chemical known to the State of California, which can cause cancer or reproductive harm. Therefore, the packaging of your product may bear the following label as required by California:

STATE OF CALIFORNIA PROPOSITION 65 WARNING:

 **WARNING**

Cancer and Reproductive Harm - www.P65Warnings.ca.gov

2 Preventing material damage

NOTICE:

The functionality of the appliance may be impaired if you use the wrong quantity of fabric softener, detergent, care product or cleaning agent.

- ▶ Follow the dosage recommendations from the manufacturer.
- ▶ Only use fabric softeners or products to eliminate static that are specifically recommended for this purpose by the product manufacturer.

Exceeding the maximum load capacity impairs the function of the appliance.

- ▶ Observe the maximum load capacity for each programme and do not exceed it.

→ "Programs", Page 21

The appliance is secured for transportation using transport locks. Transit bolts which have not been removed may result in material damage and damage to the appliance.

- ▶ Before starting up the appliance, remove the transit bolts completely and keep them in a safe place.
- ▶ Before transport, fit the transit bolts fully in order to prevent damage in transit.

Material damage may be caused if the water inlet hose is connected incorrectly.

- ▶ Tighten the screw connections on the water inlet until they are hand-tight.
- ▶ Connect the water inlet hose directly to the water tap, without any additional connecting elements such as adapters, extensions, or valves.
- ▶ Make sure that the valve housing for the water inlet hose does not come into contact with its surroundings and is not subjected to any external forces.
- ▶ Ensure that the inner diameter of the water tap is at least 17 mm.
- ▶ Make sure that the length of the thread on the connection to the water tap is at least 10 mm.

If the water pressure is too high or too low, this may impair functioning of the appliance.

- ▶ Make sure that the water pressure in the water supply system is at least 14.5 psi (100 kPa) and max. 145 psi (1000 kPa).
- ▶ If the water pressure exceeds the maximum value specified, a pressure-reducing valve must be installed between the drinking water connection and the hose set of the appliance.
- ▶ Do not connect the appliance to the mixer tap of an unpressurised hot-water boiler.

Modified or damaged water hoses may result in material damage and damage to the appliance.

- ▶ Never kink, crush, modify or cut through water hoses.
- ▶ Only use the water hoses supplied with the appliance or genuine spare hoses.
- ▶ Never re-use water hoses that have been used before.

Operating the appliance using water that is dirty or too hot may lead to material damage and damage to the appliance.

- ▶ Only operate the appliance with cold or warm (max. 60 °C/140 °F) mains water.

Unsuitable cleaning agents may damage the surfaces of the appliance.

- ▶ Do not use strong or abrasive cleaning agents.
- ▶ Do not use cleaning agents with a high alcohol content.
- ▶ Do not use hard scouring pads or cleaning sponges.
- ▶ Clean the appliance with nothing but water and a soft, damp cloth.
- ▶ Remove all detergent residue, spray residue or other residues immediately if they come into contact with the appliance.

3 Environmental protection and energy-saving

3.1 Disposal of packaging

The packaging materials are environmentally compatible and can be recycled.

- ▶ Sort the individual components by type and dispose of them separately.

3.2 Save energy and conserve resources

If you follow these instructions, your appliance will use less power and water.

Choose programs with low temperatures and longer wash times and use maximum load capacity.

- ✓ Energy consumption and water consumption is most efficient.

Add detergent based on the laundry's degree of soiling.

- ✓ For light to normal soiling, a smaller amount of detergent is sufficient. Observe the dosage recommendation from the detergent manufacturer.

Reduce the washing temperature for lightly and normally soiled laundry.

- ✓ At lower temperatures, the appliance consumes less energy. For light to normal soiling, lower temperatures than indicated on the care label are also sufficient.

Set the maximum spin speed if you want to dry the laundry in a tumble dryer afterwards.

- ✓ The drier the laundry, the shorter the program duration when drying which, in turn, reduces energy consumption. A higher spin speed reduces the residual moisture in the laundry and increases the volume of the spin noise.

Wash the laundry without prewash.

- ✓ Washing with prewash increases the program duration and increases energy and water consumption.

The appliance has an automatic load adjustment function.

- ✓ Depending on the type of fabric and load capacity, the automatic load adjustment function optimally adjusts the water consumption and program duration.

The appliance comes with an AquaSensor.

- ✓ During the rinse cycle, the AquaSensor checks the degree of turbidity of the rinsing water, and adjusts the duration and number of rinse cycles accordingly.

3.3 Energy-saving mode

If you do not use the appliance for an extended period, it automatically switches to energy-saving mode.

Energy-saving mode ends when you use the appliance again.

If you do not continue operating the appliance, it automatically switches to standby mode.

4 Installation and connection

4.1 Unpacking the appliance

NOTICE:

Objects remaining in the drum that are not designed for operation with the appliance may cause material damage and damage to the appliance.

- ▶ Remove these objects, along with all supplied accessories, from the drum before starting the appliance.

1. Remove any packaging and protective covers completely from the appliance.

→ "Disposal of packaging", Page 8

2. Check the appliance for visible damage.
3. Open the door.
4. Remove any accessories from the drum.
5. Close the door.

4.2 Included in delivery

After unpacking all the parts, check for any damage in transit and for completeness of delivery.

NOTICE:

If the appliance is operated with incomplete or defective accessories, the appliance may not be able to operate properly, or this may result in material damage and damage to the appliance.

- ▶ Do not operate the appliance with incomplete or defective accessories.
- ▶ Replace the accessories in question before operating the appliance.

→ "Accessories", Page 24

Note: The appliance has undergone a function test at the factory. This may cause water stains in the appliance, which the first wash cycle removes.

The delivery consists of the following:

- Washing machine
- Accompanying documents

- Transit bolts
→ "Removing the transit bolts", Page 10
- Cover caps
- Water inlet hoses
→ "Connecting the water inlet hoses", Page 11
- Elbow for securing the water outlet hose
- Power adapter with fuses

4.3 Requirements for the installation location

⚠ WARNING

The appliance contains live parts. Touching live parts is dangerous.

- ▶ Do not operate the appliance without a cover cap.

⚠ WARNING

When using the appliance on a base, the appliance may tip over.

- ▶ Always secure the feet of the appliance to a base using the manufacturer's fixing brackets → Page 24 before using the appliance for the first time.

NOTICE:

If residual water in the appliance freezes, this may cause damage to the appliance.

- ▶ Do not install or operate this appliance anywhere that is liable to experience frost and/or outdoors.

If the appliance is tilted at an angle greater than 40°, residual water may leak out of the appliance and cause material damage.

- ▶ Tilt the appliance carefully.
- ▶ Transport the appliance in an upright position.

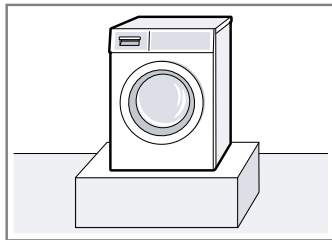
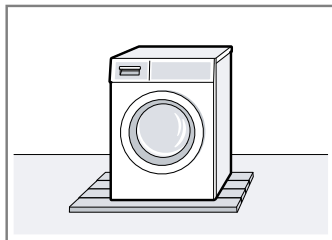
Installation location	Requirements
Base	Secure the appliance with fixing brackets → Page 24.
	
Wooden joist floor	Place the appliance on a water-resistant wooden board (minimum thickness of 1.18 in. (30 mm)) which is screwed tightly to the floor.
	

Installation location	Requirements
Kitchen unit	Only install the appliance underneath a continuous countertop that is securely connected to adjacent cabinets. Required niche width: 23.6 in. (60 cm).
Against a wall	Do not trap the power cord or the hoses between the wall and the appliance.

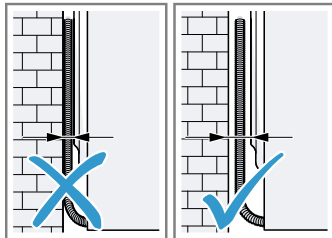
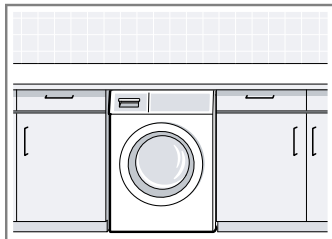

4.4 Removing the transit bolts

The appliance is secured for transportation using transit bolts on the rear of the appliance.

Note: Keep the transit bolt screws and the sleeves in a safe place for future transport.

→ "Inserting the transit bolts", Page 43

1. Pull the hoses out of the holders.

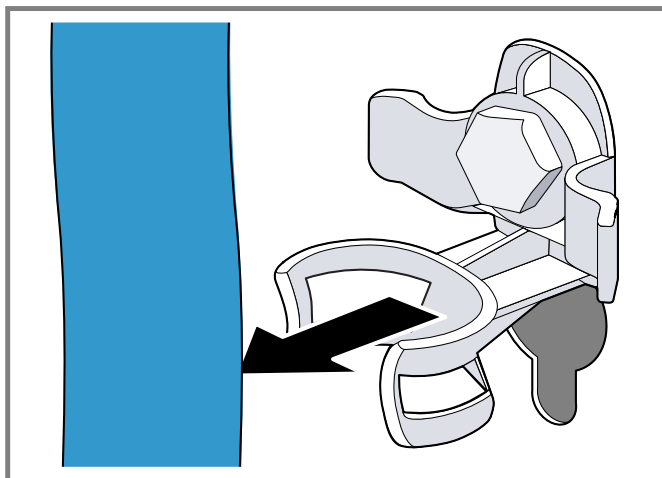

2. Unscrew ① and remove ② all of the screws for the 4 transit bolts using a 13 mm wrench.

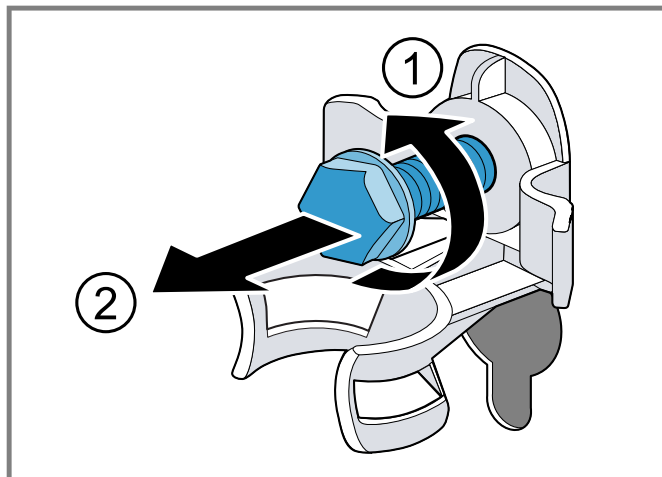

3. Remove the power cord from the holder.

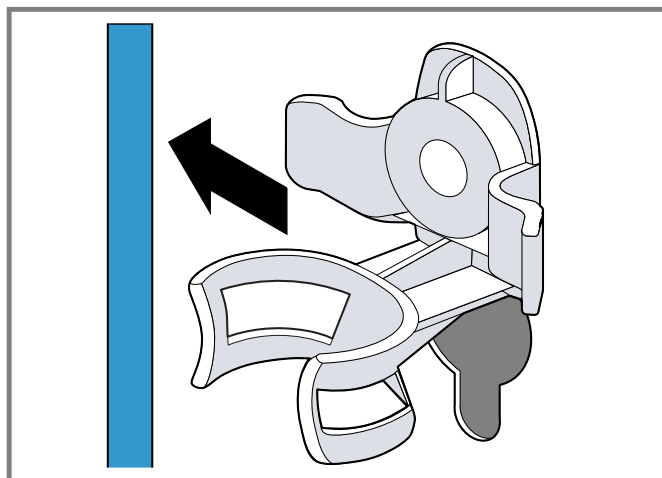

4. Remove the 4 sleeves.

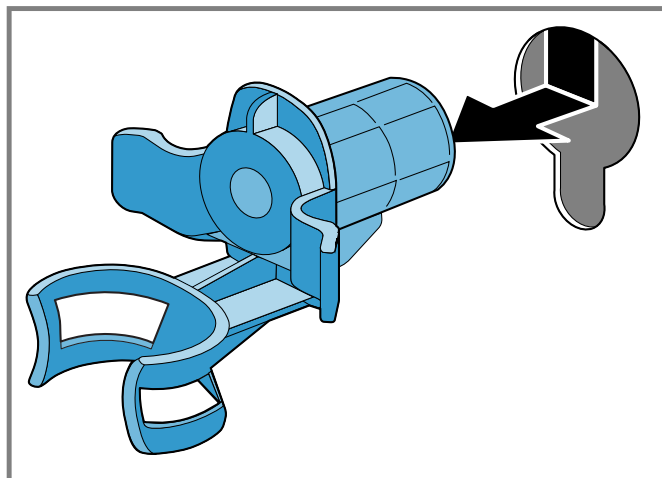

5. Put on the 4 cover caps.

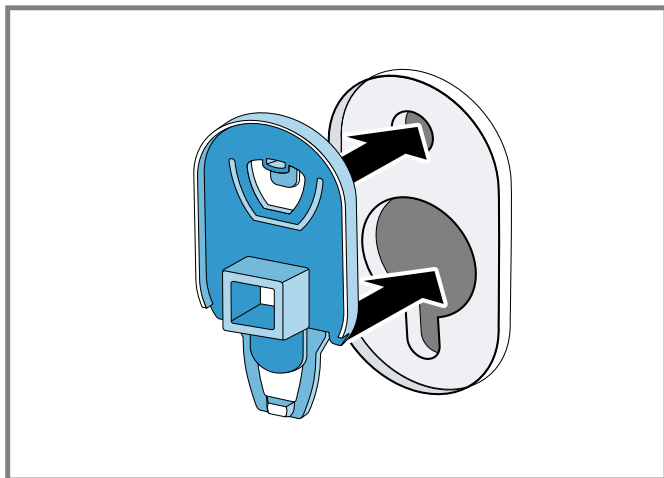

6. Push the 4 cover caps downwards.

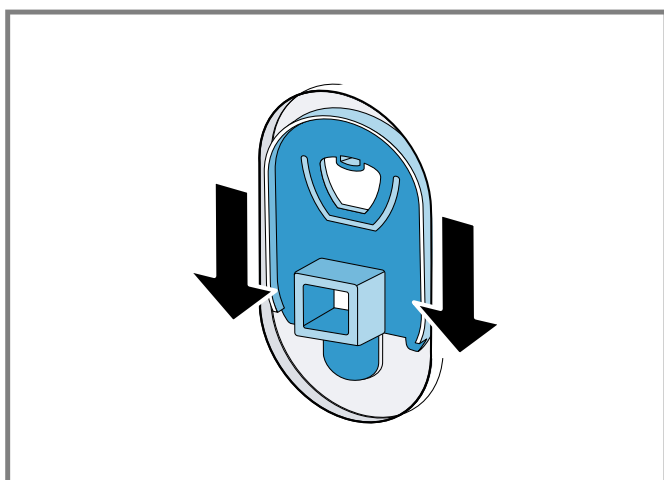

Note: To install the transport locks to transport the appliance, perform these steps again in the reverse order.

4.5 Connecting the appliance

Connecting the water inlet hoses

1. Connect the water inlet hose for hot water **a** (red) and cold water **b** (blue) to the appliance.

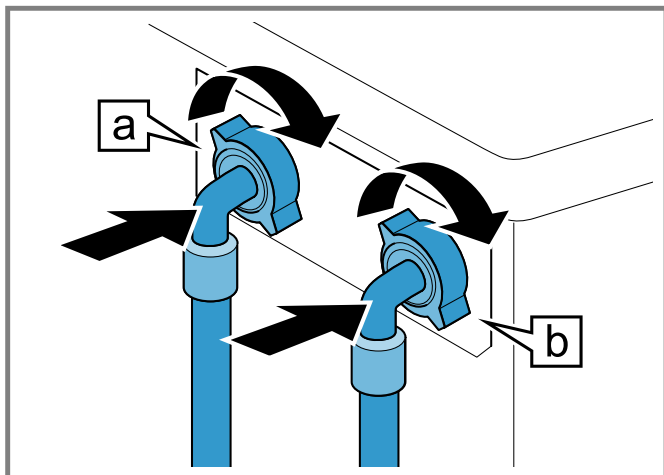

2. Connect the water inlet hose for hot water **a** (red) and cold water **b** (blue) to the faucet (26.4 mm = 3/4").

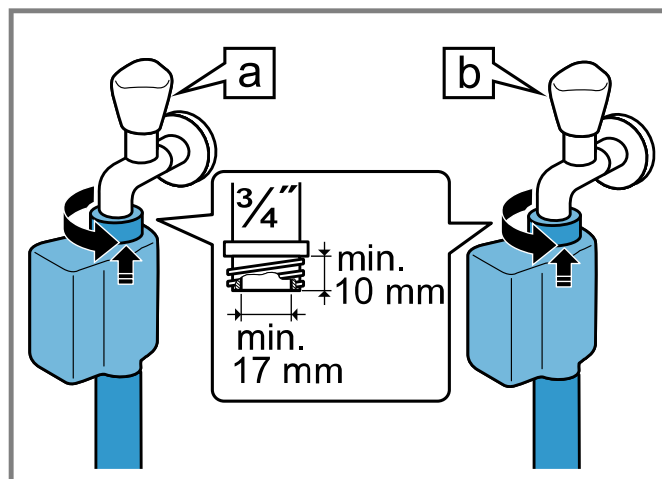

If there is no faucet for hot water, only connect the water inlet hose for cold water. Cover the hot water connection on the appliance in order to protect it from dirt.

Tip: To protect against dirt, use a 3/4" end cap on the hot water connection of the appliance.

3. Open the faucets carefully and check that the connection points are tight.

Water outlet connection types

This information is intended to help you to connect this appliance to the water outlet.

NOTICE:

When draining, the water drain hose is subject to water pressure and may come loose from the installed connection point.

- ▶ Secure the water drain hose against unintentional loosening.

Note: Observe the draining heights.

The maximum draining height is 39 in. (100 cm).

Siphon

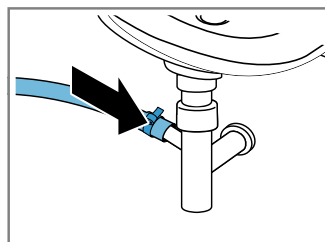

Secure the connection point with a (0.94–1.57 in. (24–40 mm)) hose clamp.

Washbasin

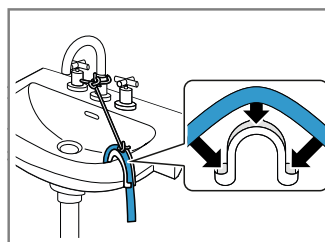

Fix and secure the water outlet hose with an elbow.

Plastic pipe with rubber sleeve or gully

Fix and secure the water outlet hose with an elbow.

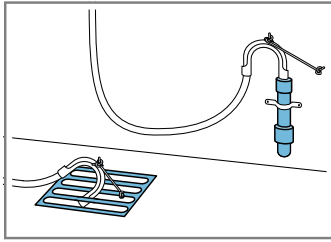

Connecting the appliance to the electricity supply

Note: Your electrical domestic installation for this appliance must comply with the local legal provisions and safety regulations, and should include a residual current circuit breaker.

1. Insert the power adapter with the line side into a suitable socket close to the appliance.
Observe the user manual that is enclosed with the power adapter.
2. Insert the mains plug for the appliance's power cord into the power adapter's load side.
The connection details of the appliance can be found under Technical data → *Page 44*.
3. Check the power plug is inserted properly.

4.6 Aligning the appliance

In order to reduce noise and vibrations, and to prevent the appliance from moving, align the appliance correctly.

1. Use a 17 mm wrench to loosen the lock nuts in a clockwise direction.

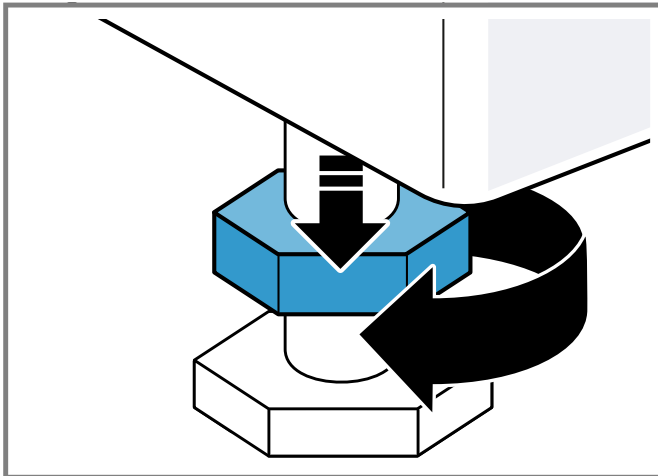

2. To align the appliance, turn the appliance feet. Check that the appliance is level using a spirit level.

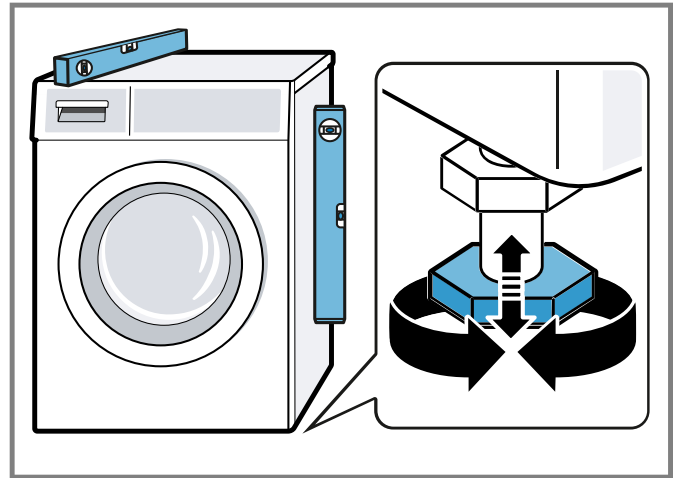

All appliance feet must stand firmly on the ground.

3. Use a 17 mm wrench to tighten the lock nuts against the housing until they are hand-tight.

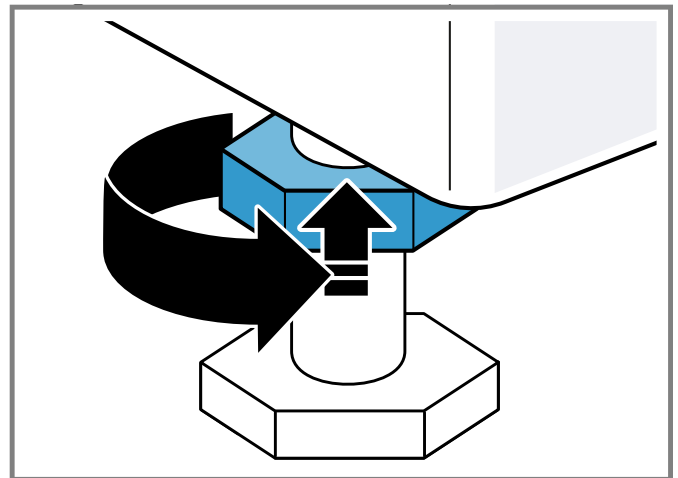

In doing so, hold the appliance foot tight and do not adjust its height.

5 Before using for the first time

Prepare the appliance for use.

5.1 Starting an empty washing cycle

Your appliance was inspected thoroughly before leaving the factory. To remove any residual water, run the first wash cycle without any laundry.

1. Press .
- The switch-on process takes a few seconds.
2. Set the **Drum Clean** program.
3. Close the door.
4. Pull out the detergent drawer.

5. Add washing powder containing oxygen bleach to the manual dosing compartment.

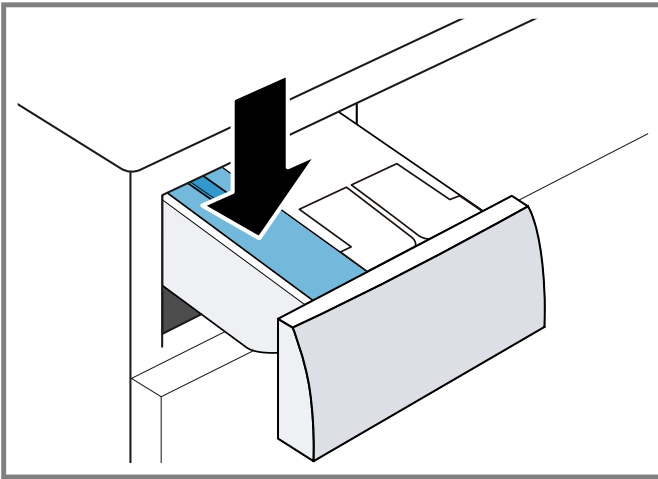

To prevent foaming, use only half of the amount of detergent recommended by the detergent manufacturer for light soiling. Do not use detergent suitable for woolens or delicates.

6. Push in the detergent drawer.
7. Press **II** **▶** to start the program.
 - ✓ The display shows the remaining program duration.
 - ✓ After the program has ended, the display shows: **End**.
8. Start the first wash cycle or press **⏻** to put the appliance in standby mode.
→ "Basic Operation", Page 24

6 Familiarizing yourself with your appliance

6.1 Appliance

Here you can find an overview of the parts of your appliance.

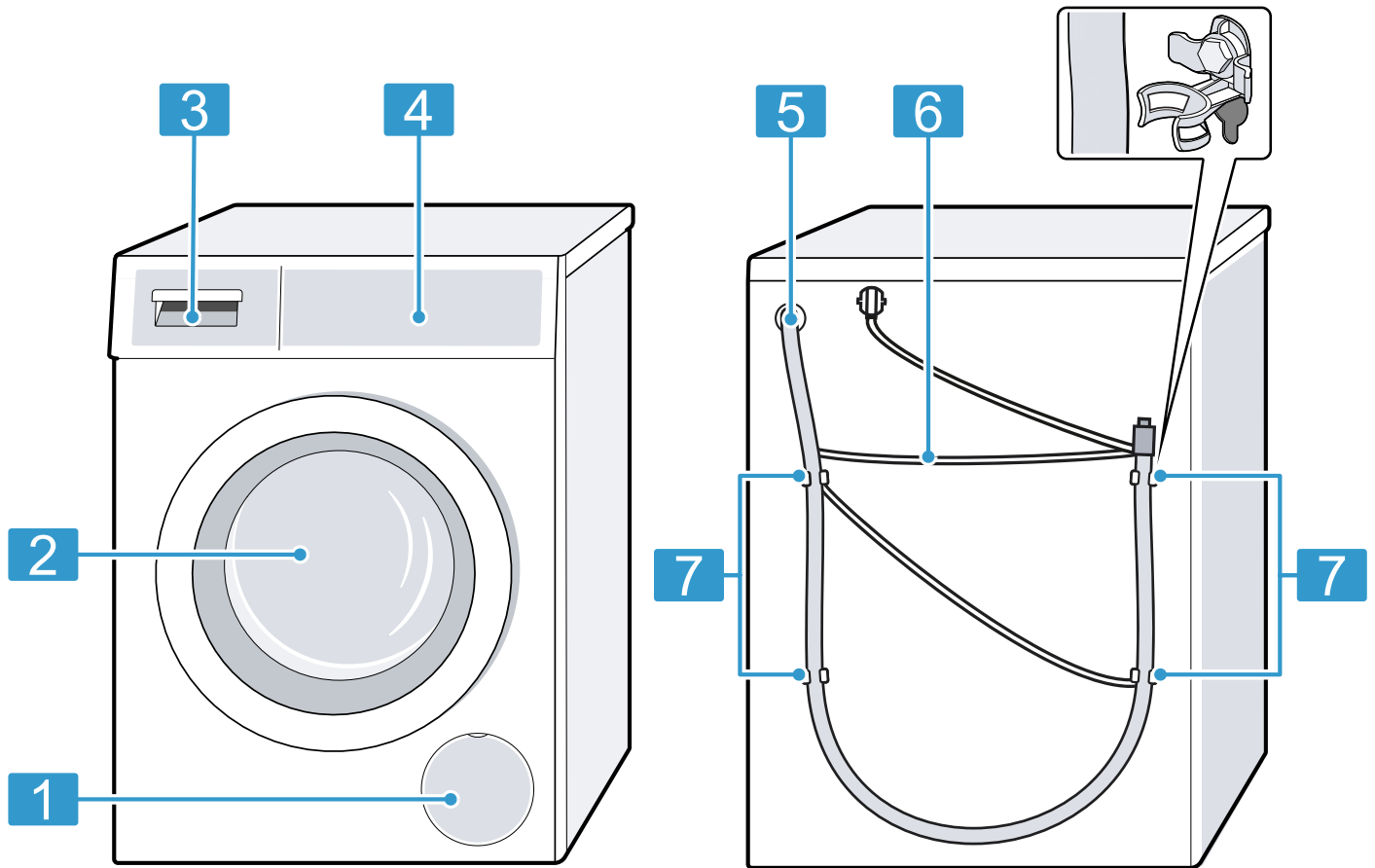

On certain models, specific details such as the color and shape may differ from those pictured.

- | | |
|---|--|
| 1 | Maintenance flap for the drain pump → <i>Page 31</i> |
| 2 | Door |
| 3 | Detergent drawer → <i>Page 14</i> |
| 4 | Control panel → <i>Page 15</i> |
| 5 | Water drain hose → <i>Page 11</i> |
| 6 | Power cord → <i>Page 12</i> |
| 7 | Transit bolts → <i>Page 10</i> |

6.2 Detergent drawer

Note: Observe the manufacturer's instructions on the use and dosage of the detergent and care product and the information in the program descriptions.

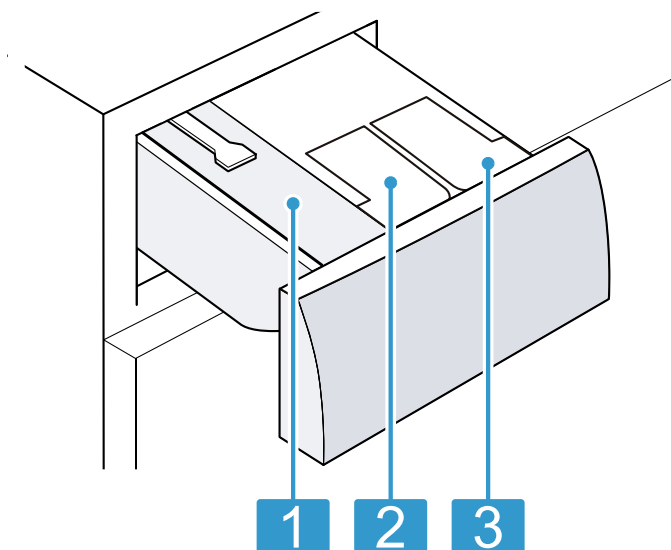

-
- 1** Manual dosing compartment
→ "Using the manual dosing compartment",
Page 27
-
- 2** ☼ / ◊ : Dispenser for fabric softener or liquid
detergent
→ "Intelligent dosing system", Page 26
-
- 3** ◊ : Dispenser for liquid detergent
→ "Intelligent dosing system", Page 26
-

6.3 Control panel

You can use the control panel to configure all functions of your appliance and to obtain information about the operating status.

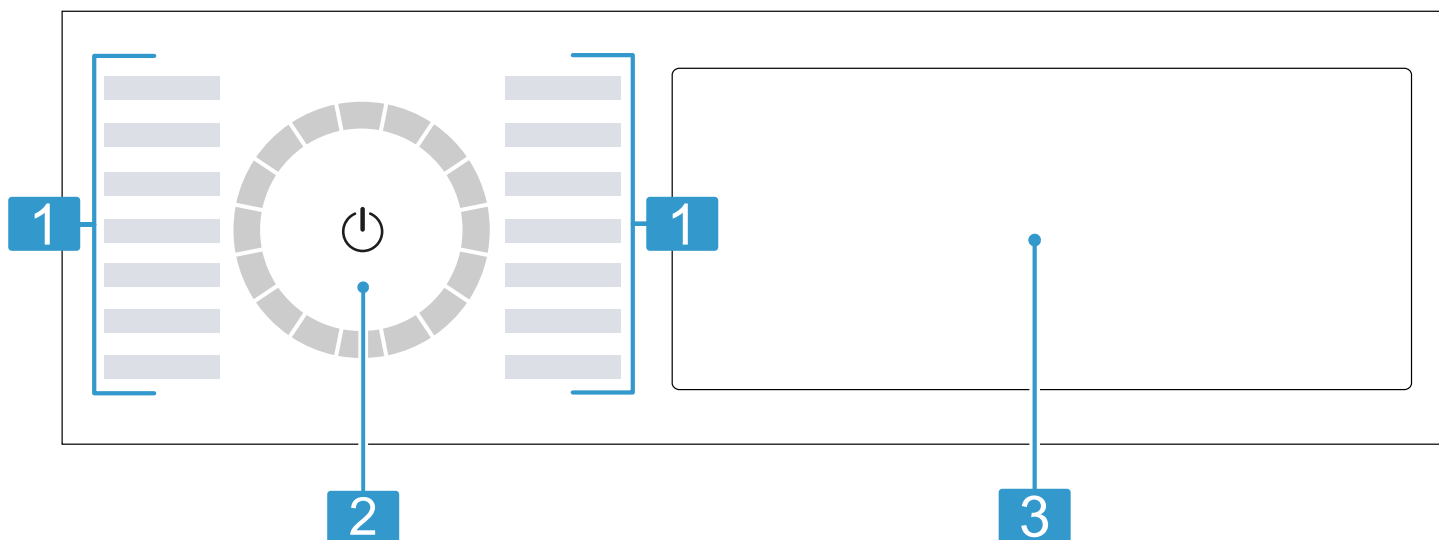

-
- 1** Programs → Page 21
-
- 2** Program selector → Page 24
-
- 3** Buttons → Page 19 and display → Page 17
-

6.4 Operating logic

Some areas of the display are buttons and respond to touch. You can activate, deactivate or change settings by pressing the buttons. The activated settings are highlighted brightly on the display.

NOTICE:

Pressing on the display with force may cause damage.

- ▶ Do not apply heavy pressure on the display.
- ▶ Do not press on the display using pointed or sharp objects.

Displaying or hiding additional buttons

Some buttons are hidden for a reduced display. If you display these additional buttons on the display, you can activate or deactivate the corresponding settings.

1. To display the additional buttons, briefly press **More**.

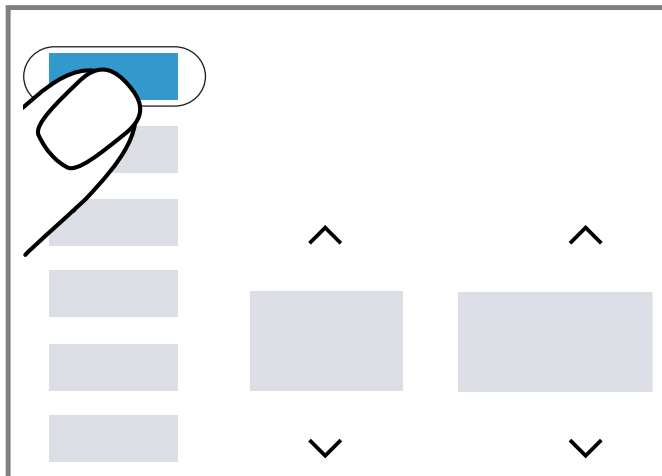

- ✓ The display shows all additional buttons.

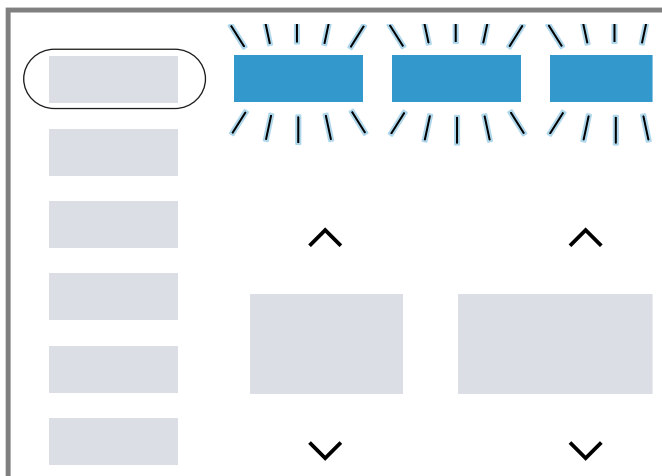

2. To hide the additional buttons, briefly press **More** again.

Changing a setting value

If you activate certain settings, the display shows selection buttons and you can change the setting value.

- ▶ Press the selection buttons → *Page 19*.

The display shows the setting value.

7 Display



The display shows the current settings, options or relevant information.

Note: Additional functions may be available as a result of software updates.

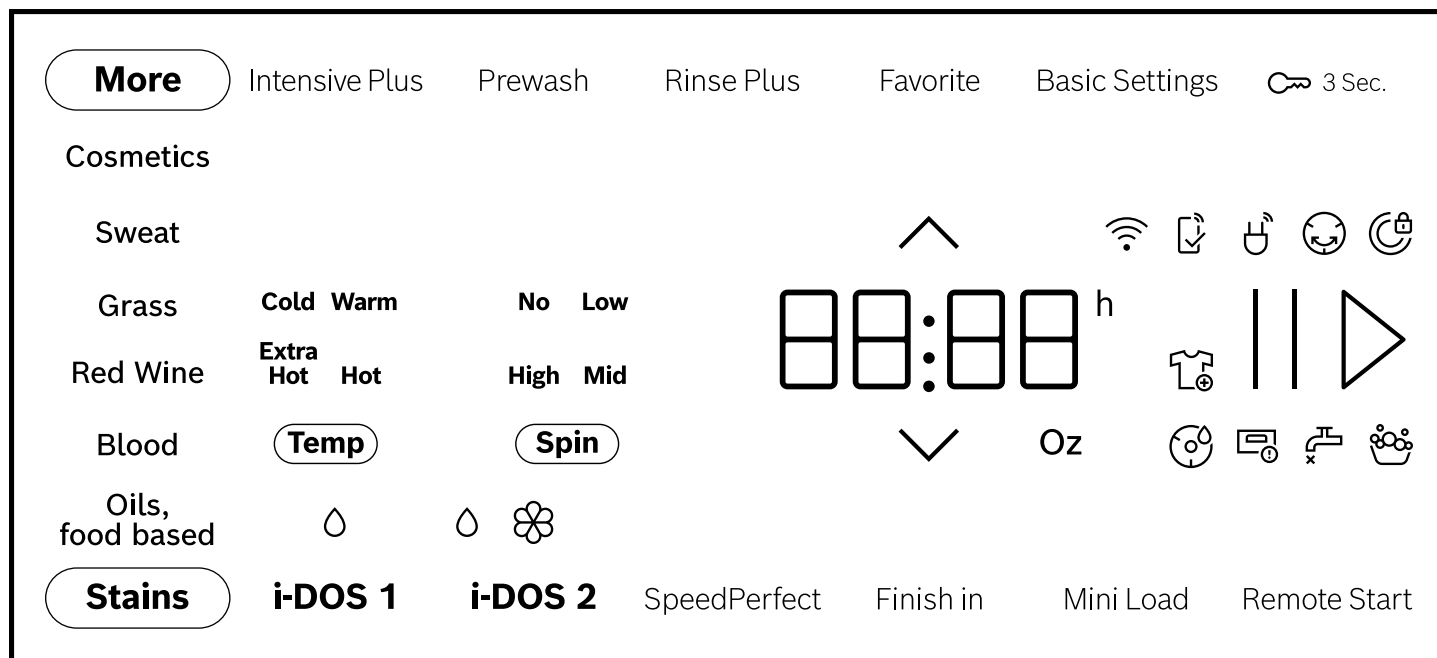















If a software update is available, you can find further information in the Home Connect® app.



Example: Display

Display	Description
00:40 ¹	Expected program duration or program time remaining in hours and minutes.
10 h ¹	Program end time → "Buttons", Page 19
No (Spin) - High	Set spin speed. → "Buttons", Page 19 No (Spin): No spin cycle, draining only
Cold - Extra Hot	Set temperature. → "Buttons", Page 19
End	Program status: Program end
	<ul style="list-style-type: none"> ■ Lights up: The control panel lock is activated. ■ Flashes: The control panel lock is activated and the appliance has been operated.
Blood	The "Blood" stain type is activated.
Grass	The "Grass" stain type is activated.
Cosmetics	The "Cosmetics" stain type is activated.
Red Wine	The "Red wine" stain type is activated.
Sweat	The "Sweat" stain type is activated.
Oils, food based	The "Cooking fat/cooking oil" stain type is activated.
	Flashes: Drum cleaning is required. Run the Drum Clean program for cleaning and caring for the drum and the outer tub. → "Cleaning the drum", Page 29
	Remote start is activated. → "Buttons", Page 19

¹ Example

Display	Description
	<ul style="list-style-type: none"> ▪ Lights up: The appliance is connected to your home network via Wi-Fi. ▪ Flashes: The appliance is trying to connect to your home network via Wi-Fi. <p>→ "Home Connect®", Page 27</p>
	The appliance is connected to the smart energy system (energy manager).
	<ul style="list-style-type: none"> ▪ Lights up: The intelligent dosing system for liquid detergent is activated. ▪ Flashes: The fill level of the dispenser is below the minimum level. <p>→ "Intelligent dosing system", Page 26</p> <p> (liquid detergent)</p>
 	<ul style="list-style-type: none"> ▪ Lights up: The intelligent dosing system for liquid detergent or fabric softener is activated. ▪ Flashes: The fill level of the dispenser is below the minimum level. <p>→ "Intelligent dosing system", Page 26</p> <p> (liquid detergent)  (fabric softener)</p>
1.5 Oz ¹	Basic dosage for detergent or fabric softener. → Page 27
	The appliance has detected too much foam. →  , Page 37
	You can remove or add laundry, and interrupt the current program. → "Adding laundry", Page 26
	<ul style="list-style-type: none"> ▪ Lights up: The door is locked. <ul style="list-style-type: none"> – To add laundry, the door can be unlocked if  lights up. → "Adding laundry", Page 26 – To open the door, you can cancel the program. → "Terminating the program", Page 26 ▪ Flashes: The door is not closed.
	<ul style="list-style-type: none"> ▪ No water pressure. → "E:30 / -10 and/or ", Page 36 ▪ The water pressure from the tap is too low.
	The detergent drawer has not been pushed in fully. →  , Page 37
E:35 / -10 ¹	Fault code, fault display, signal. → "Troubleshooting", Page 35

¹ Example

8 Buttons

Note: Additional functions may be available as a result of software updates.

If a software update is available, you can find further information in the Home Connect® app.

Some buttons are hidden for a reduced display. You can display these additional buttons on the display.

→ *"Displaying or hiding additional buttons", Page 16*

The selection of program settings depends on the program that is set.

Button	Selection	More information
II ▷ (Start/Pause Reload)	<ul style="list-style-type: none"> ■ Start ■ Cancel ■ Pause 	<p>Start, cancel or pause the program.</p> <p>If II is displayed, you can pause the program.</p> <p>If ▷ is displayed, you can start the program.</p>
^ v	Multiple selection	To change a setting, press the ^ or v selection button until the display shows the required setting.
SpeedPerfect	<ul style="list-style-type: none"> ■ Activate ■ Deactivate 	<p>Activate or deactivate a shorter program duration.</p> <p>Note: Energy consumption increases. The washing result is not affected by this.</p>
Intensive Plus	<ul style="list-style-type: none"> ■ activate ■ deactivate 	<p>Activate or deactivate an extended washing program. The program duration is extended by up to 30 minutes. Suitable for heavily soiled laundry.</p>
Stains	Multiple selection	<p>Select the type of stain.</p> <p>The temperature, drum movement and soaking time are all adjusted to suit the type of stain.</p>
i-DOS 1	<ul style="list-style-type: none"> ■ Activate ■ Deactivate ■ Setting the basic dosage amount 	<p>Briefly press the button to activate or deactivate the intelligent dosing system for liquid detergent \odot.</p> <p>Press and hold the button for approximately 3 seconds to set the basic dosage. → <i>Page 27</i></p>
i-DOS 2	<ul style="list-style-type: none"> ■ Activate ■ Deactivate ■ Adapting the dispenser ■ Setting the basic dosage amount 	<p>Briefly press the button to activate or deactivate the intelligent dosing system for fabric softener \otimes or liquid detergent \odot.</p> <p>Press the button for approximately 3 seconds to adapt the contents of the \otimes/\odot dispenser or set the basic dosage.</p> <p>→ <i>"Intelligent dosing system", Page 26</i></p>
Finish in	Up to 24 hours	<p>Set the program end time.</p> <p>The program duration is already included in the set number of hours.</p> <p>Once the program has started, the program duration is displayed.</p> <p>Note: Press ^ or v until the display shows the required setting.</p>
Temp	Cold - Extra Hot	Adjust the temperature.
Spin	No (Spin) - High	<p>Adjust the spin speed or deactivate the spin cycle.</p> <p>If No (Spin) is selected, the water is drained and the spin cycle is deactivated. The laundry stays wet inside the drum.</p>
\odot (mains switch)	<ul style="list-style-type: none"> ■ Switch on ■ Standby mode ■ Restart the appliance 	<p>Switch on the appliance or put it in standby mode.</p> <p>If the control panel does not respond, press and hold \odot for approximately 5 seconds to restart the appliance.</p> <p>→ <i>"The appliance is not working.", Page 37</i></p>
Remote Start	<ul style="list-style-type: none"> ■ Activate ■ Deactivate ■ Open the Home Connect® menu 	→ <i>"Remote start", Page 28</i>
∞ 3 sec.	<ul style="list-style-type: none"> ■ Activate ■ Deactivate 	→ <i>"Control panel lock", Page 26</i>
Basic Settings	Multiple selection	→ <i>"Basic settings", Page 29</i>

Button	Selection	More information
More	<ul style="list-style-type: none"> ■ Displaying or hiding additional buttons 	<ul style="list-style-type: none"> ■ If you briefly press the button, you can display or hide additional buttons. → <i>"Displaying or hiding additional buttons", Page 16</i>
Mini Load	<ul style="list-style-type: none"> ■ Activate ■ Deactivate 	<p>Wash small loads of delicate or hard-wearing fabrics. The program duration is shortened, and the water and energy consumption adjusted to the load.</p> <p>Note: If you activate the setting, the program's maximum load capacity is reduced to 1.1 lbs (0.5 kg).</p>
Prewash	<ul style="list-style-type: none"> ■ Activate ■ Deactivate 	<p>Activate or deactivate prewash, e.g., for washing heavily soiled laundry.</p> <p>Note: If the intelligent dosing system is activated, the detergent will be dispensed automatically for the prewash and the main wash. If the intelligent dosing system is deactivated, place the detergent directly in the drum for the prewash and into the manual dosing compartment for the main wash. → <i>"Detergent drawer", Page 14</i></p>
Rinse Plus	<ul style="list-style-type: none"> ■ Activate ■ Deactivate 	<p>Activate or deactivate an additional rinse cycle. Recommended for particularly sensitive skin or in regions with very soft water.</p>
Favorite	<ul style="list-style-type: none"> ■ Save ■ Set 	<p>Press the button for approx. 3 seconds to save your customized program settings. → <i>"Saving the program settings", Page 25</i> If you briefly press the button, you can set customized program settings for your program.</p>

9 Programs

Notes

- The laundry's care labels provide you with additional information on program selection.
- For programs with a temperature setting of 80 °C or 90 °C, the actual temperature may deviate from the specified temperature. The washing effect and hygiene expected at the specified temperatures is nevertheless achieved.
- Additional functions may be available as a result of software updates.

If a software update is available, you can find further information in the Home Connect® app.

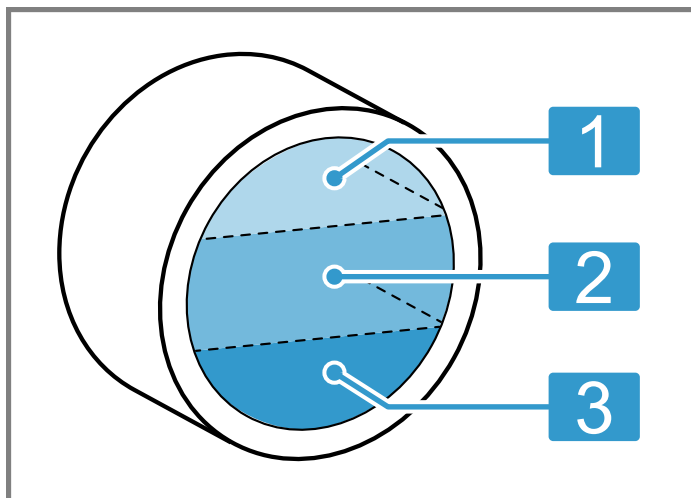

1 Large load

2 Medium load

3 Small load

Program	Description	Max. load
Cotton	Wash hard-wearing items made from cotton, linen, or blended fabrics. Suitable for normally soiled laundry. Also suitable as a short program for normally soiled laundry when you activate SpeedPerfect. Program setting: <ul style="list-style-type: none"> ■ Max. temperature: Extra Hot ■ Max. spin speed: High 	large medium ¹
Whites	Wash hard-wearing white-colored items made from cotton, linen, or blended fabrics. Suitable for heavily to lightly soiled laundry. Program setting: <ul style="list-style-type: none"> ■ Max. temperature: Extra Hot ■ Max. spin speed: High 	large
Mix	Wash items made from cotton, linen, or synthetic or blended fabrics. Suitable for lightly soiled laundry. Program setting: <ul style="list-style-type: none"> ■ Max. temperature: Extra Hot ■ Max. spin speed: High 	medium
Sanitize	Wash hard-wearing items made from cotton or linen. Wash with more water and at a defined temperature. Suitable for allergy-sufferers and for strict hygiene requirements. Program setting: <ul style="list-style-type: none"> ■ Temperature: Extra Hot ■ Max. spin speed: High 	medium

¹ SpeedPerfect activated

² Washing not possible

Program	Description	Max. load
Delicates	<p>Wash delicate, washable items made from silk, viscose and synthetics. Use a detergent that is suitable for delicates or silk.</p> <p>Note: Wash especially delicate items or items with hooks, eyelets or clips in a mesh laundry bag.</p> <p>Program setting:</p> <ul style="list-style-type: none"> ■ Max. temperature: Hot ■ Max. spin speed: Mid 	small
Hand Wash/Wool	<p>Wash hand- or machine-washable items that are made from wool or contain wool.</p> <p>To prevent the laundry from shrinking, the drum moves the items very gently with long pauses.</p> <p>Use a detergent that is suitable for wool.</p> <p>Program setting:</p> <ul style="list-style-type: none"> ■ Max. temperature: Hot ■ Max. spin speed: Mid 	small
Rinse	<p>Rinses and then spins the laundry, and then drains the water.</p> <p>Program setting: Max. spin speed: High</p>	–
Spin/Drain	<p>Spins the laundry and drains the water.</p> <p>If you only want to drain the water, activate No (Spin). The laundry is not spun.</p> <p>Program setting: Max. spin speed: High</p>	–
 App Programs	<p>Select additional programs directly via the Home Connect® app. A description of the programs can be found in the Home Connect® app.</p> <p>Note: Your appliance must be connected to your home network and registered in your Home Connect® app. → "Home Connect® ", Page 27</p>	–
Towels	<p>Hard-wearing items made from cotton or blended fabrics, e.g. towels and bathrobes.</p> <p>Program setting:</p> <ul style="list-style-type: none"> ■ Max. temperature: Extra Hot ■ Max. spin speed: High 	medium
Automatic	<p>Wash hard-wearing items made from cotton, or synthetic or blended fabrics. The degree of soiling and the type of fabric are automatically detected. The washing process is adapted.</p> <p>Note: The temperature and spin speed cannot be adjusted in this program and are set automatically. The maximum temperature is Hot The maximum spin speed is High</p>	medium
Bedding	<p>Wash pillows or quilts stuffed with synthetic fibers, or down fillings. Wash large items separately. Use a detergent that is suitable for down or delicates. Use sparingly. Do not use fabric softener.</p> <p>Note: To prevent excessive foaming, remove air from laundry items by rolling them up before you wash them.</p> <p>Program setting:</p> <ul style="list-style-type: none"> ■ Max. temperature: Extra Hot ■ Max. spin speed: High 	small

¹ **SpeedPerfect** activated

² Washing not possible

Program	Description	Max. load
Jeans	<p>Wash dark-colored and color-intense items made from cotton or permanent press fabric, e.g. jeans.</p> <p>Turn laundry inside-out before washing.</p> <p>Use liquid detergent.</p> <p>Program setting:</p> <ul style="list-style-type: none"> ■ Max. temperature: Hot ■ Max. spin speed: High 	medium
Drum Clean	<p>Clean and care for the drum.</p> <p>Use this program in the following cases:</p> <ul style="list-style-type: none"> ■ Before using the appliance for the first time ■ If you regularly wash at temperatures of Hot or lower ■ After an extended period of non-use <p>Use washing powder containing oxygen bleach. Add washing powder containing oxygen bleach to the manual dosing compartment.</p> <p>→ "Detergent drawer", Page 14</p> <p>Halve the amount of detergent to avoid foaming.</p> <p>Do not use fabric softener.</p> <p>Do not use liquid detergent or detergent that is intended for woolens or delicates.</p> <p>Note: The drum cleaning indicator flashes to remind you if you have not used a program at temperature of Extra Hot for a long time.</p>	— ²
SuperQuick 15/30	<p>Wash items made from cotton, or synthetic or blended fabrics.</p> <p>Short program for small items of lightly soiled laundry.</p> <p>Note: To adjust the program duration, activate or deactivate SpeedPerfect.</p> <p>Program setting:</p> <ul style="list-style-type: none"> ■ Max. temperature: Hot ■ Max. spin speed: High 	medium small ¹

¹ **SpeedPerfect** activated

² Washing not possible

10 Accessories

Only use original accessories. These are designed especially for your appliance.

Note: Some accessories are available in other colors.

Contact

→ "Customer Service", Page 44.

	Use	Order number
Water inlet hose extension	Extend the water inlet hose for cold water or Aquastop (approx. 2.50 m / 98,4 in).	WMZ2381
Fixing brackets	Improves the stability of the appliance.	WMZ2200
Platform	Install the appliance at a raised height so that it can be easily loaded and unloaded.	WMZPW2XW
Washing machine cleaners	Cleaning products for maintaining the appliance interior.	00311929
Power adapter	Connect the appliance to a NEMA 14-30 (4-pin) outlet.	WTZPA20UC

11 Laundry

11.1 Preparing the laundry

NOTICE:

Objects remaining in the laundry may damage the laundry and the drum.

- ▶ Remove all items from any pockets in your laundry before using the appliance.

Note

The appliance and fabrics are protected when you prepare your laundry.

- Brush off sand and soil
- Sort the laundry according to color and fabrics and observe the care labels
- Close all zippers, hook and loop fasteners, hooks and eyes
- Tie cloth belts, cloth straps and cords together
- Remove curtain fittings and lead strips
- Wash small or particularly delicate items in a mesh washing bag
- Wash large and small items of laundry together
- Wash laundry with fresh stains immediately
- Pretreat laundry with dried stains and wash several times
- Load the laundry unfolded into the drum
- Before loading the drum, any laundry that has been pre-treated with chlorine bleach should be rinsed several times

12 Detergents and care products

You can protect your appliance and your laundry by selecting and using the correct detergents and care products.

The manufacturer's instructions for use and dosage can be found on the packaging.

Notes

- when using liquid detergents, only use liquid detergents that are self-flowing
- Do not mix different liquid detergents
- Do not mix detergent and fabric softener
- Do not use products that have expired or are highly congealed
- do not use products containing solvents, caustic agents or volatile substances
- Do not use chlorine bleach
- Do not use dyes regularly as fixing salt can damage stainless steel
- Do not use color-bleaching agents in the appliance
- Do not pour vinegar into the dispensers → Page 26 of the intelligent dosing system

13 Basic Operation

13.1 Switching on the appliance

Note: If you switch the appliance on the first time after you have connected it to the electrical system, the switch-on process takes up to one minute.

Requirement: The appliance has been correctly installed and connected.

→ "Installation and connection", Page 9

- ▶ Press .

The switch-on process takes a few seconds.

- ✓ An audible function test is carried out.

Note: The lighting for the drum goes out automatically.

13.2 Setting a program

1. Press the required program.
→ "Programs", Page 21

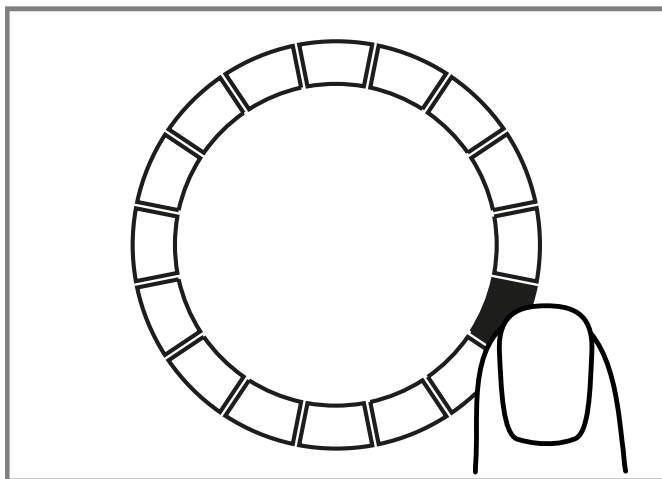

- ✓ The display shows the program settings.
2. If required, adjust the program settings. → Page 25

Setting additional programs

Requirement: Home Connect® is set up.
→ "Setting up Home Connect®", Page 28

1. Set the  **App Programs** program.
Remote Start flashes.
2. Press **Remote Start**.
The Home Connect® app displays the programs that can be selected.
3. Set a program in the Home Connect® app.
4. If required, adjust the program settings.
→ "Changing the program settings", Page 25
5. Start the program.
→ "Starting the program", Page 25

13.3 Changing the program settings

Requirement: A program is set.
→ "Setting a program", Page 24

- ▶ Adjust the program settings.
→ "Buttons", Page 19
Observe the information about operating logic
→ Page 15.

Notes

- The program settings are not saved permanently for the program.
- The setting is saved if you activate or deactivate the intelligent dosing system.

13.4 Saving the program settings

You can save your individual program settings as favorites.

Requirements

- A program has been set.
→ "Setting a program", Page 24
- The program settings have been adjusted.
→ "Changing the program settings", Page 25
- ▶ Press and hold **Favorite** for approximately 3 seconds.
Press **Favorite** to call up the saved program.
Note: To overwrite the saved program, repeat the steps above.

13.5 Loading laundry

Note: To prevent creasing, note the maximum load for the programs.
→ "Programs", Page 21

Requirements

- The laundry is prepared and sorted.
→ "Laundry", Page 24
 - The drum is empty.
1. Open the door.
 2. Place the laundry in the drum.
 3. Close the door.
Ensure that there is no laundry trapped in the door.

13.6 Starting the program

Note: If the intelligent dosing system is activated, make sure that the dispensers have been filled → Page 26 and the basic dosage has been set → Page 27.

Requirement: A program has been set.
→ "Setting a program", Page 24

- ▶ Press **II ▷**.
- ✓ The drum rotates and load detection takes place. This can take up to 2 minutes, after which water enters the drum.
- ✓ The display shows the program duration or the program end time.
- ✓ After the program has ended, the display shows: **End**.

13.7 Soaking laundry

Note: No additional detergent is required for soaking. The appliance uses the filled detergent for soaking and washing.

Requirements

- The laundry is placed in the appliance.
→ "Loading laundry", Page 25
 - A program has started.
→ "Starting the program", Page 25
1. Press **II ▷** approx. 10 minutes after the program start.
The program pauses and the laundry can soak.

- Press **II ▷** after the required soaking time.

13.8 Adding laundry

After the program starts, you can remove or add laundry depending on the program status.

- Press **II ▷**.

The appliance pauses.

Note: If you want to add laundry, follow the instructions on the display.

→ "Display", Page 18

→ "Display", Page 18

- Open the door.
- Add or remove laundry.
- Close the door.
- Press **II ▷**.

13.9 Terminating the program

- Press **II ▷**.
- Open the door.

The appliance door remains locked for safety reasons if the temperature and water levels are high.

- If the temperature is high, start the **Rinse** program.
- If the water level is high, start the **Spin** program or select a suitable program for draining.

→ "Programs", Page 21

- Remove the laundry. → Page 26

13.10 Removing the laundry

- Open the door.
- Remove the laundry from the drum.

13.11 Put the appliance into standby mode

- Press **⏻**.
- Turn off the tap.
- Wipe the rubber gasket dry and remove any foreign objects.

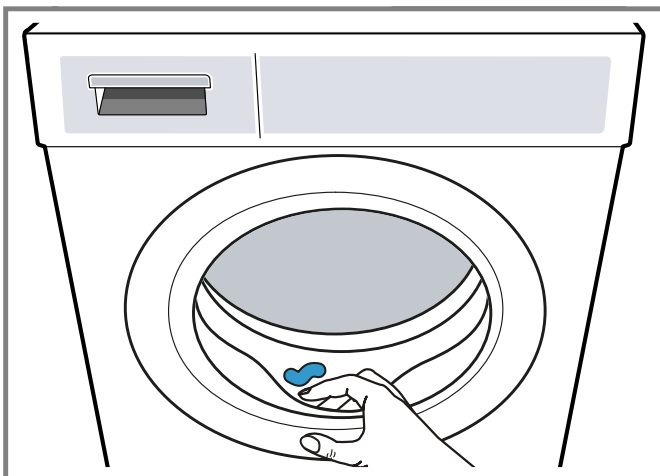

- Leave the appliance door and detergent drawer open so that residual water can evaporate.

14 Control panel lock

Secure your appliance against being operated unintentionally using the controls.

14.1 Activating the control panel lock

- ▶ Press and hold **☞ 3 sec.** for around 3 seconds.
- ✓ The display shows **☞**.
- ✓ The control elements are locked.
- ✓ The control panel lock also remains activated when the appliance is in standby mode and in the event of a power failure.

14.2 Deactivating the control panel lock

Requirement: To deactivate the control panel lock, the appliance must be switched on.

- ▶ Press and hold **☞ 3 sec.** for around 3 seconds.
- ✓ **☞** goes out on the display.

15 Intelligent dosing system

The appliance's intelligent dosing system is activated at the factory and automatically doses liquid detergent and fabric softener for any programs in which intelligent dosing is possible.

Note: You can use the buttons → Page 19 to deactivate the intelligent dosing system, e.g. in order to manually dose washing powder → Page 27.

15.1 Pouring liquid detergent and fabric softener into the dispensers

If you are using the intelligent dosing system or if the appliance displays a notification during operation of the appliance, fill the dispensers.

Notes

- Only pour suitable liquid detergent and fabric softener into the dispensers. → Page 24
- If you add more liquid detergent or fabric softener to the dispenser, use the same product.
- If you want to replace the liquid detergent or fabric softener in the dispenser with another product, clean the detergent drawer beforehand → Page 29.
- If you are using the intelligent dosing system, do not add additional detergent or fabric softener into the compartment for manual dosing. This is to prevent overdosing or foam formation.

- Pull out the detergent drawer.

2. Open the lid.

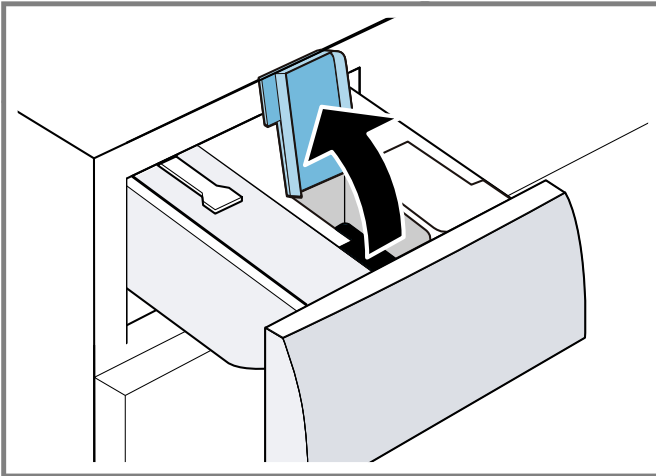

3. Pour liquid detergent O and fabric softener X into the relevant dispensers → Page 14.

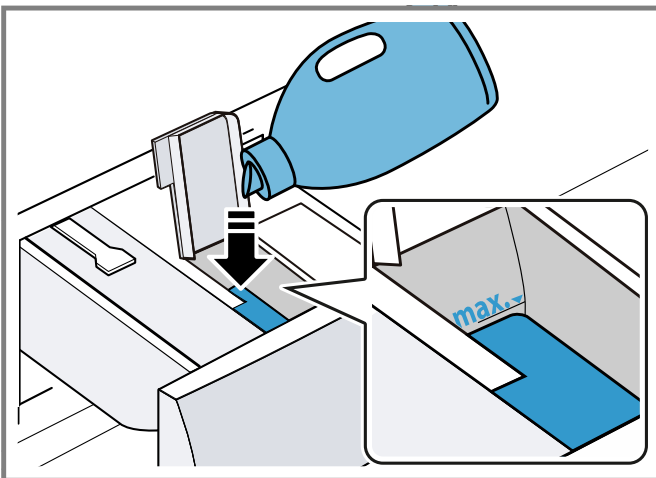

Do not exceed the marking for the maximum fill level when filling.

Note: You can also use both dispensers for liquid detergent. Adapt the dispenser for this. → Page 27

4. Close the lid.

Note: To prevent the liquid detergent or fabric softener from drying out, close the lids immediately after filling.

5. Push in the detergent drawer.

15.2 Using the manual dosing compartment

If you are not using the intelligent dosing system, if intelligent dosing is not possible for a program, or if you want to add additional care product, e.g. stain remover or starch, use the manual dosing compartment.

Note: Observe the information about detergents and care products → Page 24.

1. Pull out the detergent drawer.
2. Pour laundry detergent or care product into the manual dosing compartment → Page 14.
3. Push in the detergent drawer.

15.3 Adapting the X/O dispenser

The X/O dispenser can dose fabric softener X or liquid detergent O . When it leaves the factory, the dispenser is set for fabric softener. If you want to automatically dose a second liquid detergent, adapt the dispenser.

Notes

- If you adapt the contents of the dispenser, the basic dosage for this dispenser is reset.
 - If you use both dispensers for liquid detergent, you must set a dispenser which is to be used during washing.
→ "Buttons", Page 19
1. Press and hold **i-DOS 2** for approximately 3 seconds.
 2. Press **i-DOS 2** repeatedly until the display shows O (liquid detergent) or X (fabric softener).
 3. Wait briefly to save the setting.

15.4 Setting the basic dosage amount

To allow for intelligent dosing, set the basic dosage amount for the dispenser. The basic dosage amount corresponds to the dosage recommendation from the detergent manufacturer on the packaging. Set the basic dosage amount that corresponds to the dosage recommendation for 11 lbs (5 kg) of normally soiled laundry.

Tip: You can also set the basic dosage amount in the Home Connect® app.

1. Press and hold **i-DOS 1** for approximately 3 seconds.
 - ✓ The display shows the set basic dosage amount.
2. To adjust the setting, press $\wedge \vee$.
3. Wait briefly to save the setting.

Note: To set the basic dosage amount for the other dispenser, repeat the steps with **i-DOS 2**.

16 Home Connect®

This appliance is network-capable. Connecting your appliance to a mobile device lets you control its functions via the Home Connect® app, adjust its basic settings and monitor its operating status.

The Home Connect® services are not available in every country. The availability of the Home Connect® function depends on the availability of Home Connect® services in your country. You can find information on this at: www.home-connect.com.

The Home Connect® app guides you through the entire registration process. Follow the instructions in the Home Connect® app to implement the settings.

Tip: Follow the instructions in the Home Connect® app as well.

Notes

- Also note the safety information in this instruction manual and ensure that it is also observed when operating the appliance using the Home Connect® app. → "Safety", Page 4
- Operating the appliance on the appliance itself always takes priority. It is not possible to operate the appliance using the Home Connect® app during this time.

16.1 Setting up the Home Connect® app

1. Install the Home Connect® app on your mobile device.
2. Start the Home Connect® app and set up access for Home Connect®.

The Home Connect® app guides you through the entire registration process.

16.2 Setting up Home Connect®

Requirements

- The Home Connect® app is installed on your mobile device.
- The appliance receives signals from the WLAN home network (Wi-Fi) at its installation location.

1. Press and hold **Remote Start** for around 3 seconds.
2. Follow the instructions in the Home Connect® app.

16.3 Home Connect® menu

The Home Connect® menu contains all of the Home Connect® settings.

Calling up the Home Connect® menu

- ▶ Press and hold **Remote Start** for at least 3 seconds.
- ✓ The display shows the first setting of the Home Connect® menu.

Navigating in the Home Connect® menu

- ▶ Briefly press **Remote Start** until the display shows the required setting.

Exiting the Home Connect® menu

- ▶ Press and hold **Remote Start** for at least 3 seconds.

16.4 Activating Wi-Fi on the appliance

Requirements

- The Home Connect® menu is called up. → Page 28
- The display shows "oFF".
- ▶ Press **II ▷** to change the setting.
- ✓ The display shows "on" if the Wi-Fi is activated.

Note: If the Wi-Fi is activated, the display alternately shows "on" and the signal strength of the Wi-Fi connection.

16.5 Deactivating Wi-Fi on the appliance

Requirements

- The Home Connect® menu is called up. → Page 28
- The display shows "on".
- ▶ Press **II ▷** to change the setting.
- ✓ The display shows "oFF" if the Wi-Fi is deactivated.

16.6 Resetting the appliance network settings

Requirements

- The Home Connect® menu is called up. → Page 28
- The display shows **rEs**.
- ▶ Press and hold **II ▷** for at least 3 seconds.
- ✓ The network settings are reset.

16.7 Remote start

Enable the appliance for remote start via the Home Connect® app.

Note

Remote start will be deactivated in the following circumstances:

- The appliance door is opened.
- Press **Remote Start**.
- Following a power failure.

Activating remote start

Requirements

- The appliance door is closed.
- The detergent drawer has been pushed in.
- ▶ Press **Remote Start**.
- ✓  lights up and the appliance is enabled for remote start via the Home Connect® app.

Deactivating remote start

- ▶ Press **Remote Start**.
- ✓  goes out.

16.8 Remote diagnostics

The Customer Service can access your appliance via Remote Diagnostics if you ask them to do so, if your appliance is connected to the Home Connect® server and if Remote Diagnostics is available in the country where you are using the appliance.

Tip: Further information and details about the availability of Remote Diagnostics in your country can be found in the Service/Support section of your local website: www.home-connect.com.

16.9 Data Protection

Please see the information on data protection.

The first time your appliance is registered on a home network connected to the Internet, your appliance will transmit the following types of data to the Home Connect® server (initial registration):

- Unique appliance identification (consisting of appliance codes as well as the MAC address of the installed Wi-Fi communication module).
- Security certificate of the Wi-Fi communication module (to ensure a secure data connection).
- The current software and hardware version of your appliance.
- Status of any previous reset to factory settings.

This initial registration prepares the Home Connect® functions for use and is only required when you want to use the Home Connect® functions for the first time.

Note: Please note that the Home Connect® functions can be utilized only with the Home Connect® app. Information on data protection can be called up in the Home Connect® app.

17 Basic settings

You can configure the basic settings for your appliance to meet your needs.

Note: You can also adjust the the basic settings in the Home Connect® app.

17.1 Overview of the basic settings

Note: Additional functions may be available as a result of software updates.

If a software update is available, you can find further information in the Home Connect® app.

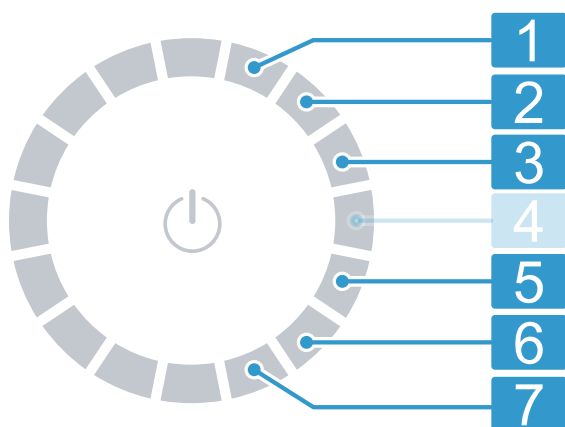

Program selector with program positions

- 1 Set the volume of the signal tone that is emitted when the program ends:
0 (off) to 4 (very loud)

- 2 Set the volume of the signal tone that is emitted when the buttons are selected:
0 (off) to 4 (very loud)
- 3 Set the display brightness:
1 (low) to 4 (very high)
- 5 Activate (On) or deactivate (OFF) the reminder to clean the drum.
- 6 Display the number of finished programs.
- 7 Restore the appliance to the factory settings (rES).

17.2 Changing the basic settings

Requirement: The display shows all additional buttons.
→ *Page 16*

1. To call up the basic settings, press **Basic Settings**.
2. Use the program selector to select the required basic setting. → *Page 29*
3. Adjust the basic setting:
 - To change the value, press \wedge or \vee .
 - To reset the appliance to the factory settings, press and hold $\parallel \triangleright$ for approx. 3 seconds.
4. Press **Basic Settings** to save the settings.

18 Cleaning and maintenance

To keep your appliance working efficiently for a long time, it is important to clean and maintain it carefully.

18.1 Cleaning the drum

⚠ CAUTION

Permanently washing at low temperatures and a lack of ventilation for the appliance may damage the drum and cause injury.

- ▶ Regularly run a program for cleaning the drum or wash at temperatures of Extra Hot.
- ▶ Leave the appliance to dry after every operation with the door open, and leave the detergent drawer to dry.
- ▶ Run the **Drum Clean** program without laundry but with washing powder that contains oxygen bleach or a cleaning agent for caring for the inside of the appliance.
→ *"Accessories", Page 24*

18.2 Cleaning the detergent drawer

If you want to replace the liquid detergent or fabric softener in the dispenser with another product or if the detergent drawer is dirty, clean the detergent dispenser.

NOTICE:

The pump unit contains electrical components. Electrical components may be damaged if they come into contact with liquids.

- ▶ Do not clean the pump unit in the dishwasher and do not immerse it in water.

- ▶ Protect the electrical connection on the rear against water, detergent and fabric softener residue.

1. Put the appliance into standby mode.
→ "Put the appliance into standby mode", Page 26
2. Pull out the detergent drawer.
3. Press down on the insert and remove the detergent drawer.

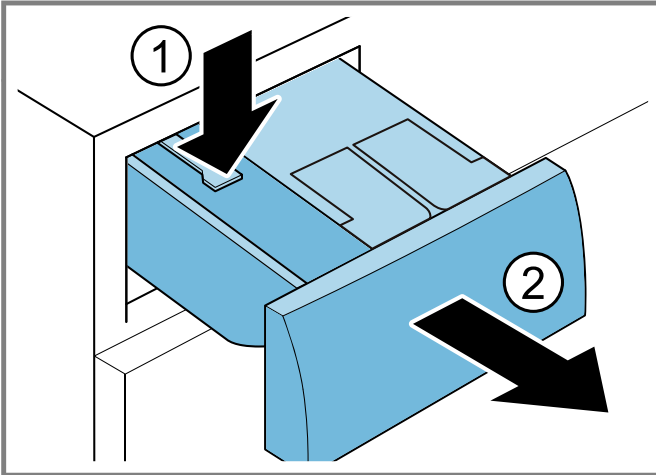

4. Remove the pump unit.

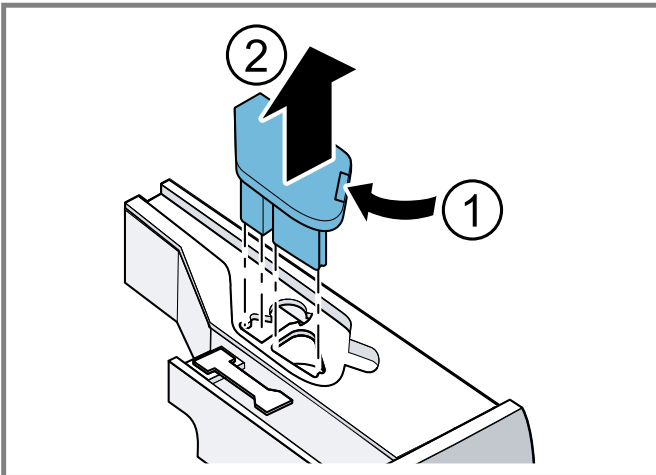

5. Unclip the detergent drawer cover and remove it.

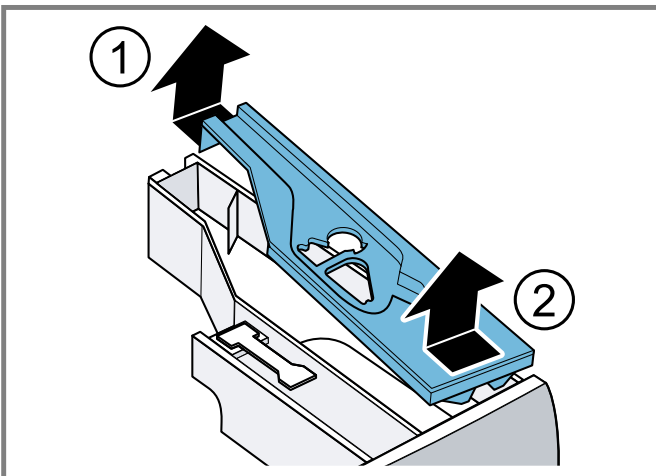

6. Empty the detergent drawer.

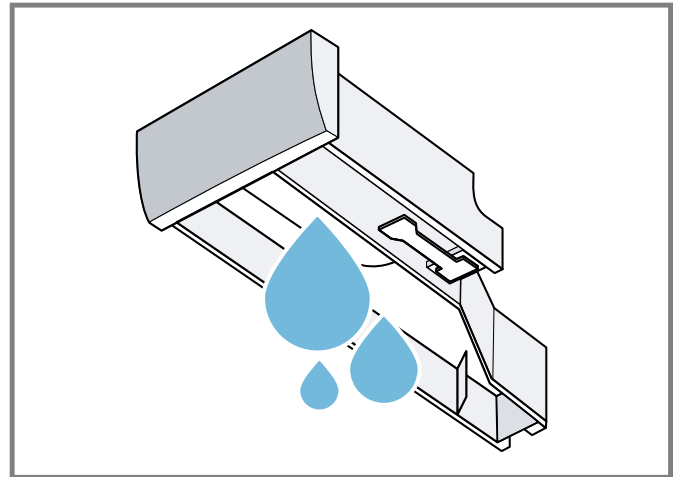

7. Clean the pump unit with a damp cloth.

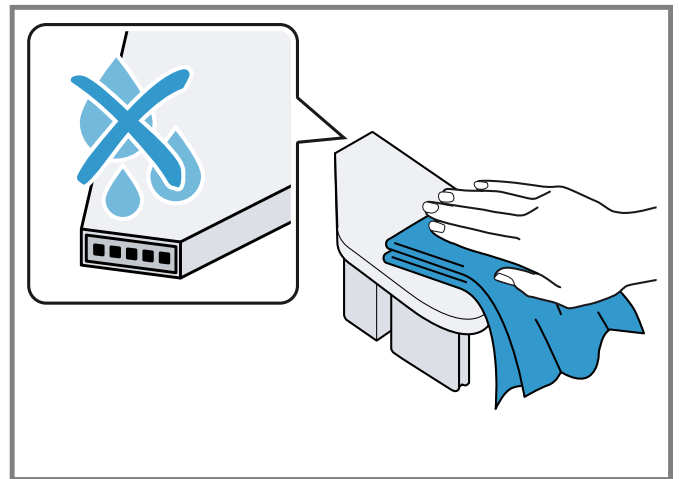

8. Clean the detergent drawer and the cover with a soft, damp cloth or hand shower.

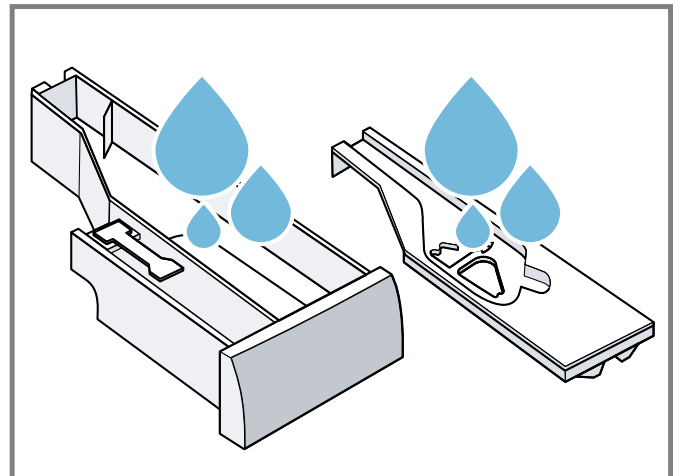

9. Dry the detergent drawer, cover and pump unit and reinsert them.

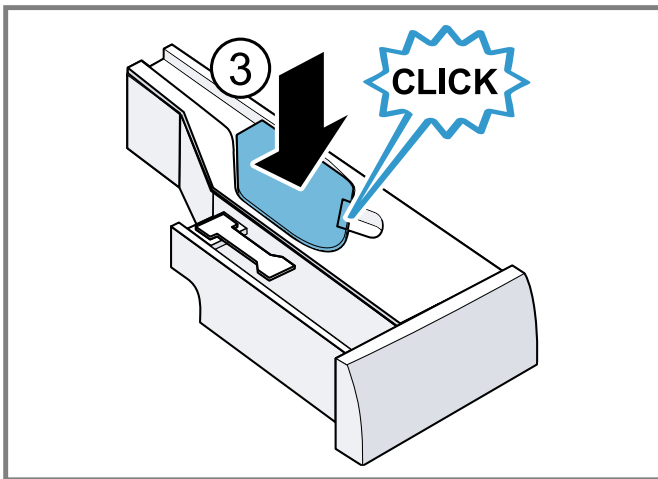
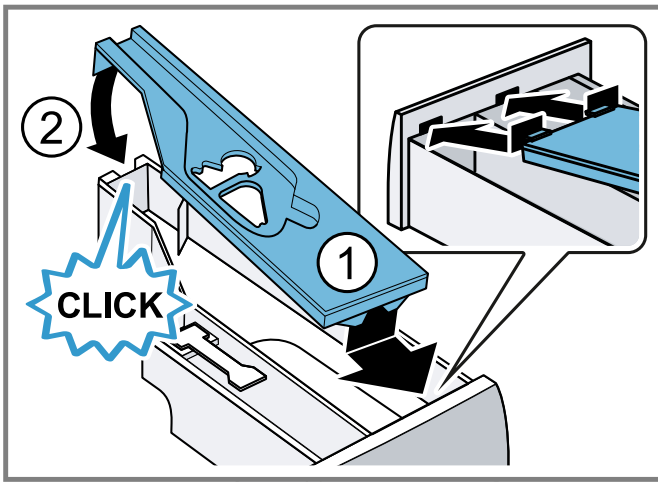

10. Clean the housing of the detergent drawer in the appliance.

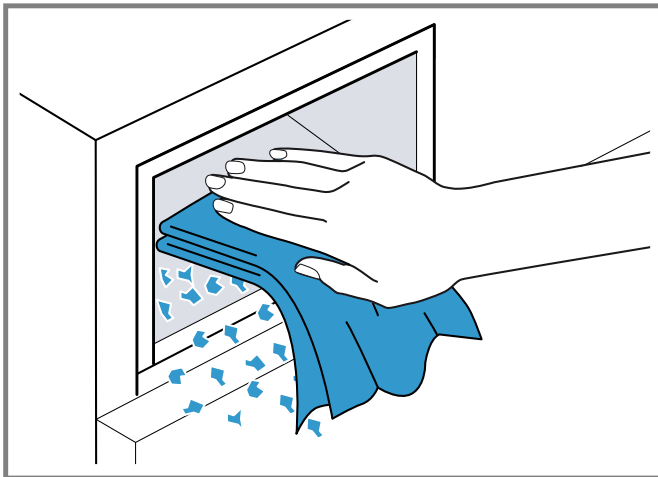

11. Push in the detergent drawer.

18.3 Cleaning the drain pump

Clean the drain pump regularly, at least once a year, as well as in the event of faults, e.g. blockages or rattling noises.

Emptying the drain pump

1. Turn off the faucet.
2. Put the appliance into standby mode. → Page 26

3. Disconnect the appliance's mains plug from the power supply.
4. Open and remove the service flap.

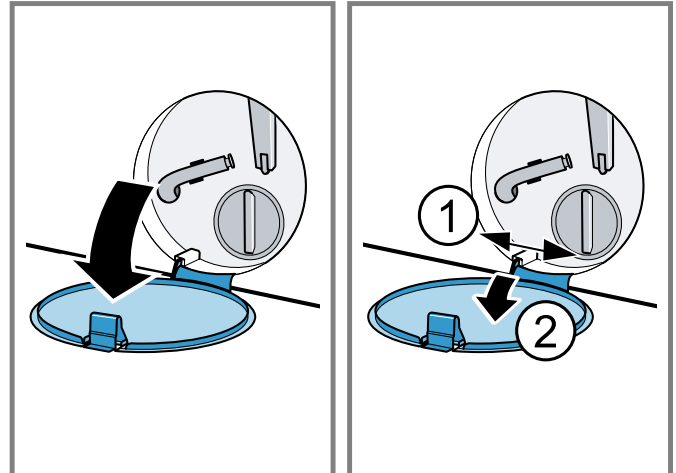

5. Loosen the screws and remove the protective film.

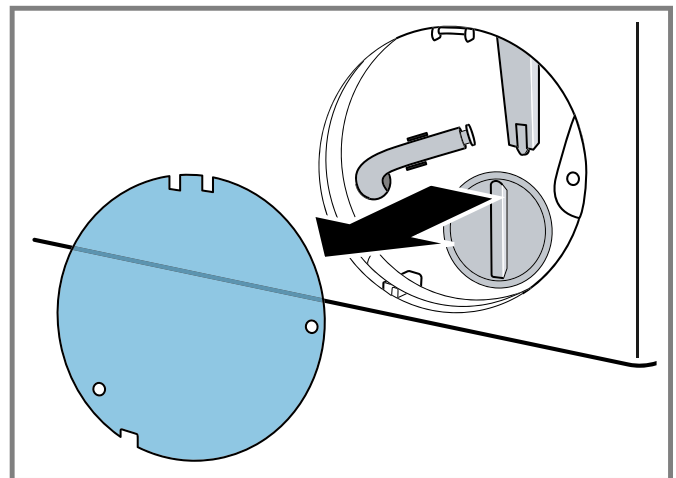
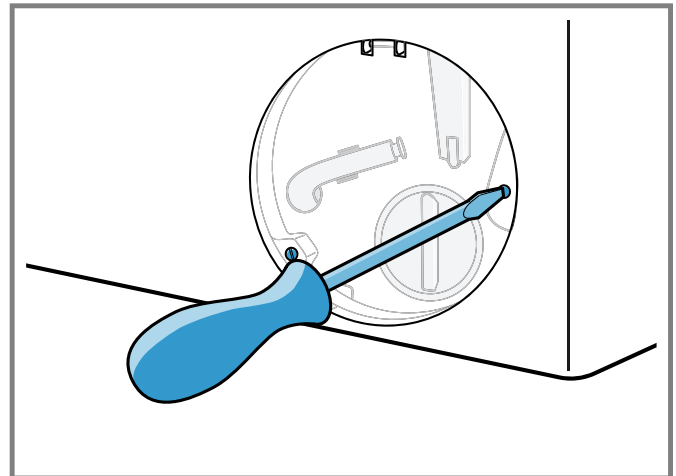

6. Slide a sufficiently large container under the opening.

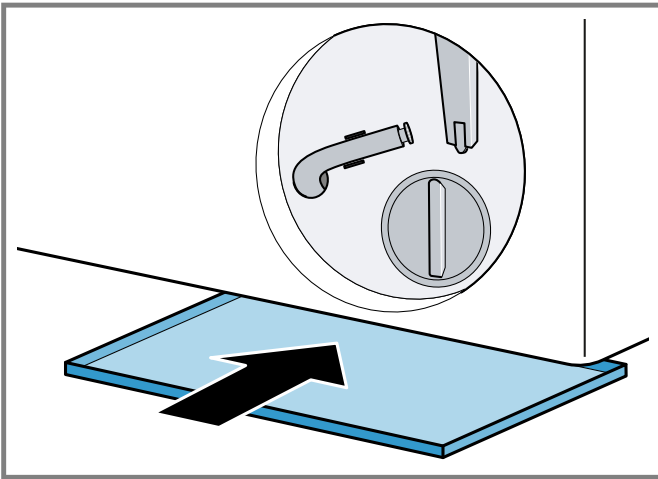

7. Take the drain hose out of the holder.

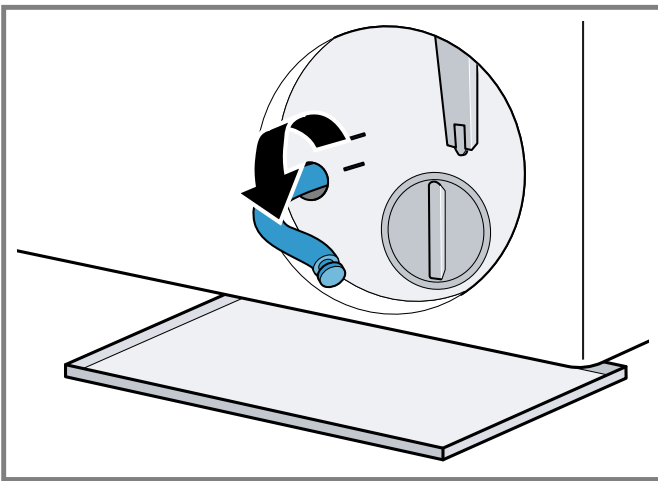

8. **⚠ CAUTION** When you wash at high temperatures, the detergent solution becomes hot.
▶ Do not touch the hot detergent solution.
To allow the detergent solution to flow out into the container, remove the sealing cap.

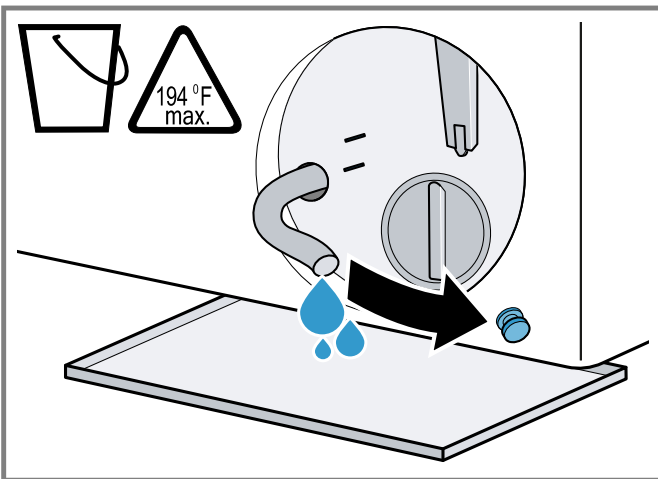

9. Firmly press on the sealing cap.

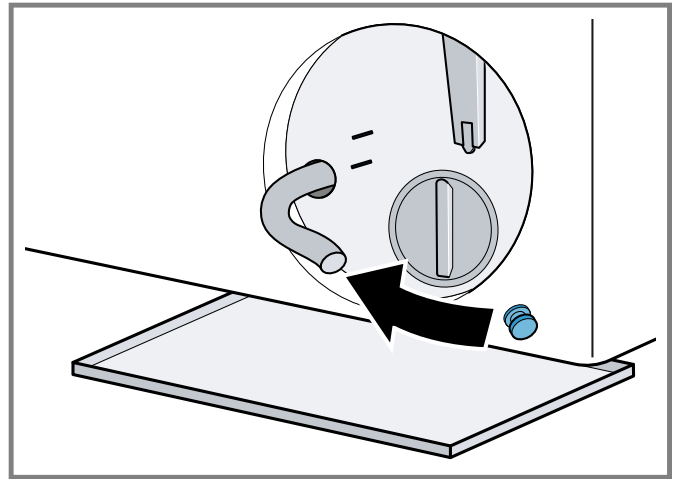

10. Clip the drain hose into the holder.

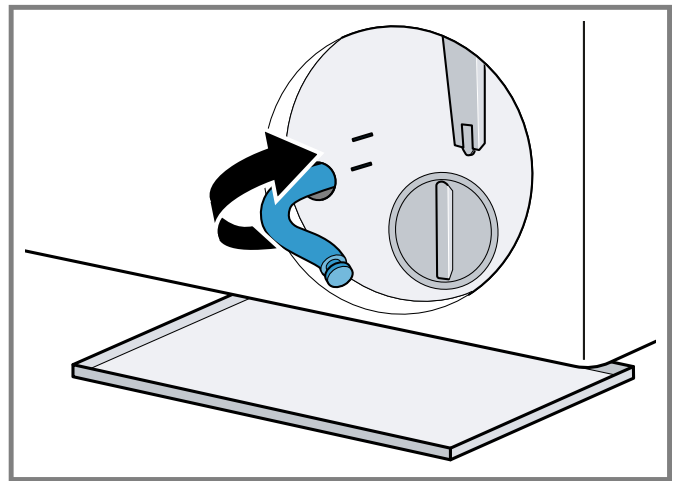

Cleaning the drain pump

Requirement: The drain pump is empty. → Page 31

1. Since water may remain in the drain pump, unscrew the pump cap carefully.
 - The filter insert in the pump housing may become stuck due to coarse particles of dirt. Loosen the dirt and remove the filter insert.

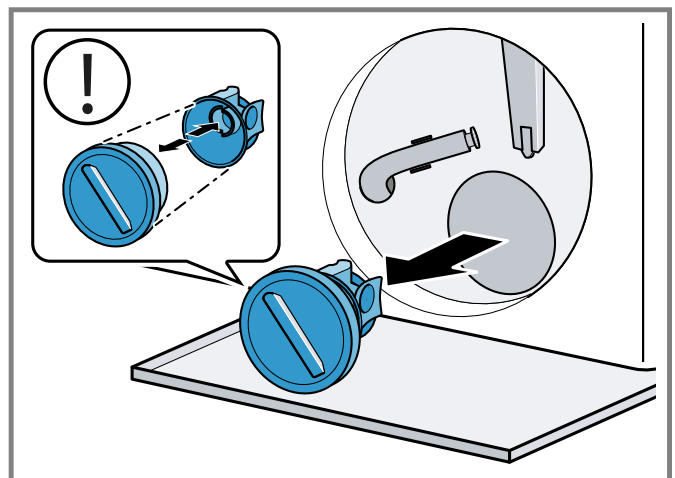

The pump cap is comprised of two parts which can be taken apart for cleaning.

2. Clean the interior, the thread on the pump cap and the pump housing.

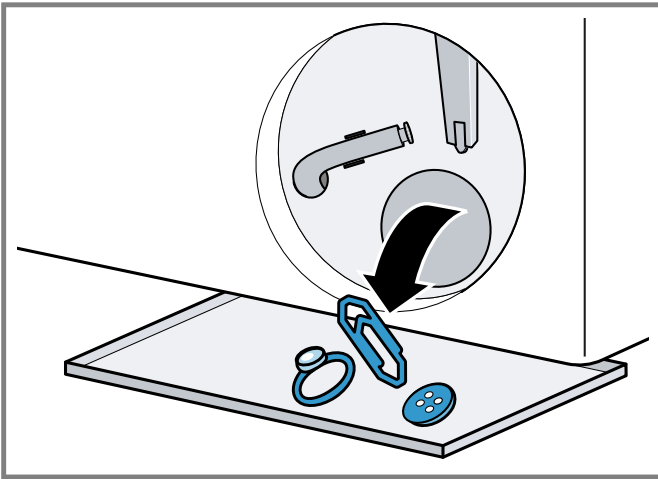

3. Ensure that both impellers can turn.

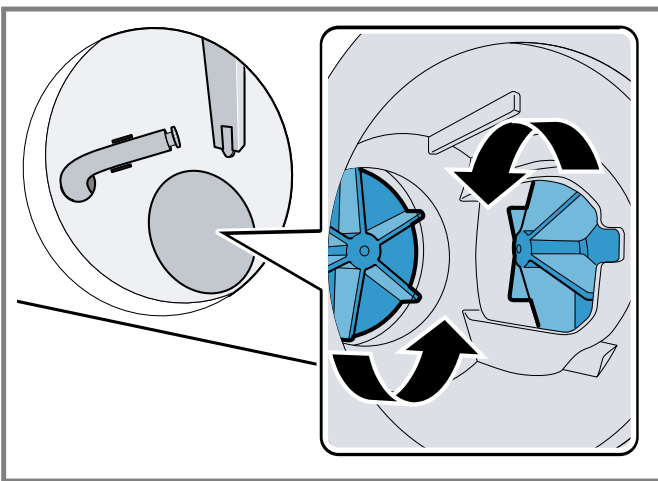

4. Insert the pump cap.

- Ensure that the parts of the pump cap are correctly assembled.

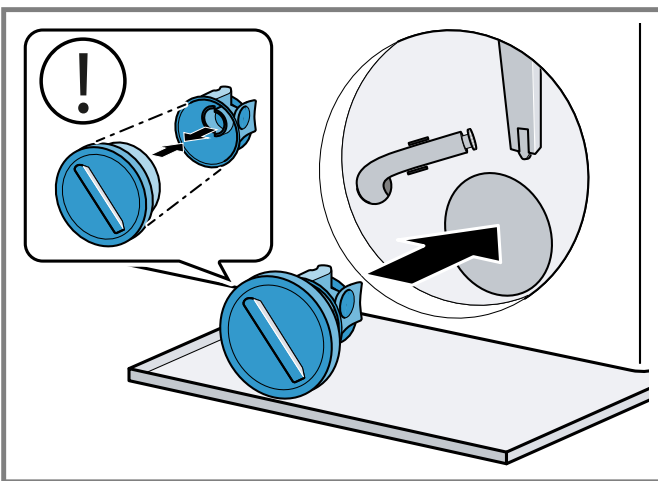

5. Screw the pump cap as far as it will go.

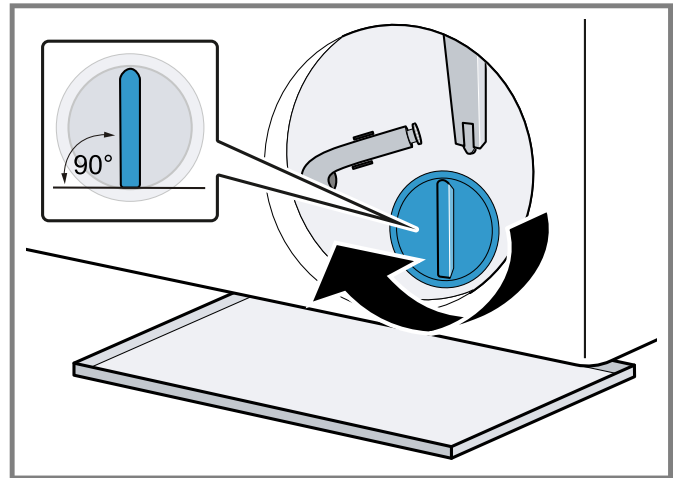

The handle on the pump cap must be in a vertical position.

6. Fit the protective film and secure with the screws.

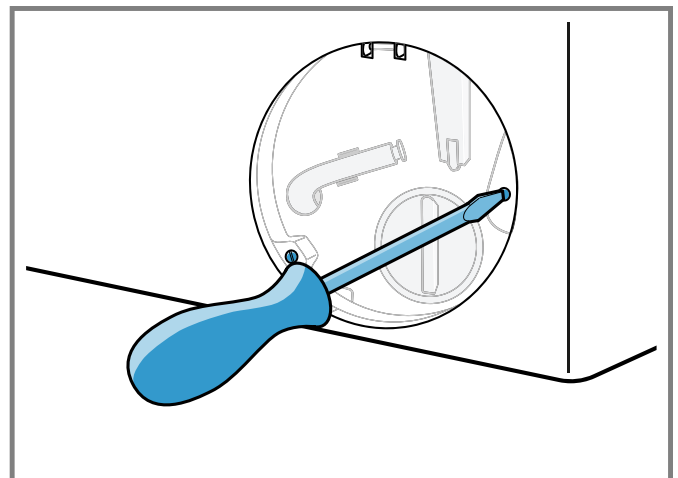
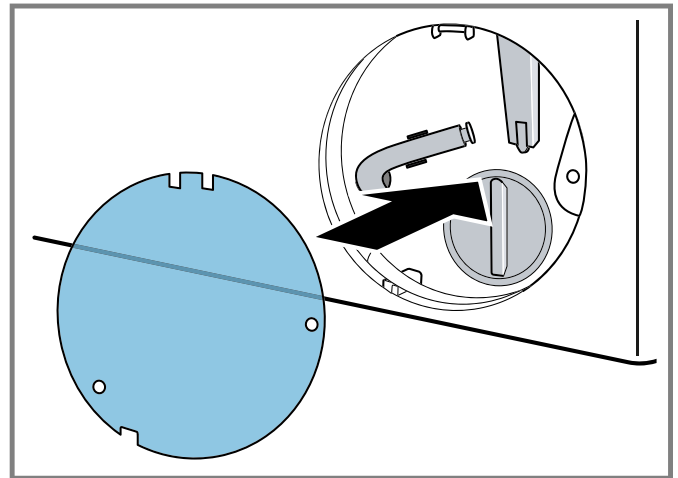

7. Insert and close the service flap.

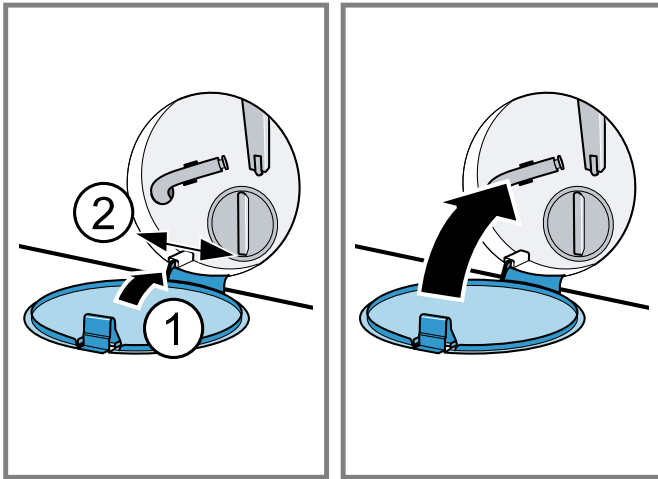

18.4 Cleaning the inlet opening in the rubber gasket

Regularly check the inlet opening in the rubber gasket for any blockages and clean the inlet opening.

1. Open the appliance door.
2. Remove any blockages from the inlet opening.

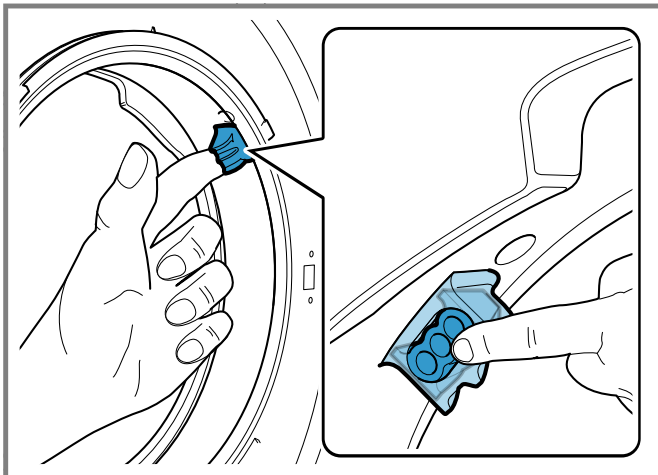

Note: Do not use any sharp or pointed objects.

19 Troubleshooting

You can eliminate minor issues on your appliance yourself. Please read the information on eliminating issues before contacting Customer Service. This may avoid unnecessary repair costs.



WARNING







Improper repairs are dangerous.

- ▶ Never make any technical modifications to the appliance or its features.

- ▶ Do not tamper with controls.
- ▶ Repairs to the appliance should only be performed by authorized service providers.
- ▶ Only original spare parts may be used to repair the appliance.
- ▶ If the power cord of this appliance becomes damaged, it must be replaced by the manufacturer, the manufacturer's Customer Service, or an authorized service provider in order to prevent injury.

Issue	Cause and troubleshooting
The display goes out and II ▶ flashes.	Energy-saving mode is active. <ul style="list-style-type: none"> ▶ Press II ▶. ✓ The display lights up again.
"E:30 / -80"	Drain pipe or water outlet hose is blocked. <ul style="list-style-type: none"> ▶ Clean the drain pipe and the water outlet hose.
	Drain pipe or water outlet hose is kinked or trapped. <ul style="list-style-type: none"> ▶ Ensure that the drain pipe and water outlet hose are not kinked or trapped.
	The water outlet hose is connected too high. <ul style="list-style-type: none"> ▶ Install the water outlet hose at a maximum height of 39 in. (1 meter).
	Unapproved extension installed on the water outlet hose. <ul style="list-style-type: none"> ▶ Remove any unapproved extensions from the water outlet hose. → "Connecting the appliance", Page 11
	Drain pump is blocked. <ul style="list-style-type: none"> ▶ Clean the drain pump. → Page 31
	Pump cap is not correctly assembled. <ul style="list-style-type: none"> ▶ Correctly assemble the pump cover.
	The pump cap is not fully screwed in. <ul style="list-style-type: none"> ▶ Ensure that the pump cap is screwed in all the way into the appliance. The handle on the pump cap must be in a vertical position.
"E:38 / -25 / -26"	Detergent dosage is too high. <ul style="list-style-type: none"> ▶ Immediate measure: Mix one tablespoon of fabric softener with 0.5 US quarts (0.5 liters) of water and pour the mixture into the compartment for manual dosing (not for outdoor clothing, sportswear or items stuffed with down). ▶ If intelligent dosing is activated, reduce the basic dosage. → Page 27 ▶ If you dose manually, reduce the amount of detergent for the next washing cycle with the same load.
	Recirculation is blocked. <ol style="list-style-type: none"> 1. Clean the drum. → Page 29 2. If the fault is displayed again, clean the drain pump. → Page 31 Inlet opening of the rubber gasket is blocked. <ul style="list-style-type: none"> ▶ Clean the inlet opening in the rubber gasket. → Page 34

Issue	Cause and troubleshooting
"E:10 / -00 / -10 / -20"	<p>The pump for the intelligent dosing system is blocked.</p> <ol style="list-style-type: none"> 1. Put the appliance into standby mode. 2. Clean the pump unit. → <i>"Cleaning the detergent drawer", Page 29</i> 3. Switch on the appliance. 4. If the display appears again after cleaning the pump unit, or the program cannot be started, call customer service. → <i>"Customer Service", Page 44</i> <p>Note: Until the fault is rectified, you can deactivate the intelligent dosing system and dose manually. → <i>"Buttons", Page 19</i></p>
"H:32"	<p>The unbalanced load detection system has interrupted the spin cycle because the laundry is unevenly distributed.</p> <ul style="list-style-type: none"> ▶ Redistribute the laundry in the drum. <p>Note: Where possible, mix large and small items in the drum. Laundry items of different size distribute themselves better during the spin cycle.</p>
"E:92 / - 01"	<p>The water pressure is low. No remedial action possible.</p> <hr/> <p>The filters in the water inlet are blocked.</p> <hr/> <p>Faucet is turned off.</p> <ul style="list-style-type: none"> ▶ Turn on the faucet. <hr/> <p>The water inlet hose is kinked or jammed.</p> <ul style="list-style-type: none"> ▶ Ensure that the water inlet hose is not kinked or jammed. <hr/> <p>Water level measurement system is defective.</p> <p>Note: With this fault message, the appliance starts a draining process.</p> <ol style="list-style-type: none"> 1. First wait approximately 5 minutes until the draining process has ended. 2. To reset the fault message, switch the appliance off. 3. Switch the appliance back on. 4. If the fault message is displayed again, call customer service. → <i>"Customer Service", Page 44</i>
"E:30 / -10" and/or 	<p>The water pressure is low. No remedial action possible.</p> <hr/> <p>The filters in the water inlet are blocked.</p> <ul style="list-style-type: none"> ▶ Clean the filters in the water inflow. <hr/> <p>Faucet is turned off.</p> <ul style="list-style-type: none"> ▶ Turn on the faucet. <hr/> <p>The water inlet hose is kinked or jammed.</p> <ul style="list-style-type: none"> ▶ Ensure that the water inlet hose is not kinked or jammed. <hr/> <p>Water level measurement system is defective.</p> <p>Note: With this fault message, the appliance starts a draining process.</p> <ol style="list-style-type: none"> 1. First wait approximately 5 minutes until the draining process has ended. 2. To reset the fault message, switch the appliance off. 3. Switch the appliance back on. 4. If the error message is displayed again, call customer service. → <i>"Customer Service", Page 44</i>
	<p>The detergent drawer has not been pushed in fully.</p> <ul style="list-style-type: none"> ▶ Push in the detergent drawer until the symbol goes out. <hr/> <p>The pump unit is not inserted.</p>

Issue	Cause and troubleshooting
	<ol style="list-style-type: none"> 1. Insert the pump unit into the detergent drawer. → "Cleaning the detergent drawer", Page 29 2. Push in the detergent drawer until the symbol goes out.
	<p>Detergent dosage is too high.</p> <ul style="list-style-type: none"> ▶ Immediate measure: Mix one tablespoon of fabric softener with 0.5 US quarts (0.5 liters) of water and pour the mixture into the compartment for manual dosing (not for outdoor clothing, sportswear or items stuffed with down). ▶ If intelligent dosing is activated, reduce the basic dosage. → Page 27 ▶ If you dose manually, reduce the amount of detergent for the next washing cycle with the same load.
	<p>Drum cleaning is required.</p> <ul style="list-style-type: none"> ▶ → "Cleaning the drum", Page 29
"E:30/-20"	<p>Detergent dosage is too high.</p> <ul style="list-style-type: none"> ▶ If you dose manually, reduce the amount of detergent for the next washing cycle with the same load. <hr/> <p>Additional water is added.</p> <ul style="list-style-type: none"> ▶ Do not add any extra water to the appliance while it is operating. <hr/> <p>Solenoid valve defective.</p> <ul style="list-style-type: none"> ▶ Call customer service. → "Customer Service", Page 44
All other fault codes.	<p>Operational fault</p> <ol style="list-style-type: none"> 1. Switch the appliance off and on again. 2. If the message appears again, disconnect the appliance from the power supply for at least 30 seconds by pulling out the plug or by switching off the relevant circuit breaker in the fuse box. <p>✓ If the fault was a one-off occurrence, the message disappears.</p> <ol style="list-style-type: none"> 3. If the message appears again, call Customer Service. Please specify the exact error message when calling. → "Customer Service", Page 44
The appliance is not working.	<p>The plug for the power cord is not plugged in.</p> <ul style="list-style-type: none"> ▶ Connect the appliance to the power supply. <hr/> <p>The circuit breaker in the circuit breaker panel has tripped.</p> <ul style="list-style-type: none"> ▶ Check the breaker panel. <hr/> <p>There has been a power failure.</p> <ul style="list-style-type: none"> ▶ Check whether the lighting in your kitchen or other appliances in the room are working. <hr/> <p>There is a software fault.</p> <ul style="list-style-type: none"> ▶ To restart the appliance, press and hold  for approximately 5 seconds.
The program does not start.	<p>II  has not been pressed.</p> <ul style="list-style-type: none"> ▶ Press II . <hr/> <p>The door is not closed.</p> <ul style="list-style-type: none"> ▶ Close the door. <hr/> <p>Control panel lock is activated.</p> <ul style="list-style-type: none"> ▶ Deactivate the control panel lock. <hr/> <p>Finish in is activated.</p> <ul style="list-style-type: none"> ▶ Check whether Finish in is activated. → "Buttons", Page 19 <hr/> <p>Laundry is caught in the door.</p> <ul style="list-style-type: none"> ▶ Remove any trapped laundry.

Issue	Cause and troubleshooting
The program does not start.	<p>The detergent drawer has not been pushed in fully.</p> <ul style="list-style-type: none"> ▶ Push in the detergent drawer until the symbol goes out.
	<p>The pump for the intelligent dosing system is blocked.</p> <ol style="list-style-type: none"> 1. Put the appliance into standby mode. 2. Clean the pump unit. <ul style="list-style-type: none"> → <i>"Cleaning the detergent drawer", Page 29</i> 3. Switch on the appliance. 4. If the display appears again after cleaning the pump unit, or the program cannot be started, call customer service. <ul style="list-style-type: none"> → <i>"Customer Service", Page 44</i>
	<p>Note: Until the fault is rectified, you can deactivate the intelligent dosing system and dose manually.</p> <p>→ <i>"Buttons", Page 19</i></p>
The washing machine door cannot be opened.	<p>Temperature is too high.</p> <ul style="list-style-type: none"> ▶ Wait until the temperature has dropped. ▶ Cancel the program. <ul style="list-style-type: none"> → <i>"Terminating the program", Page 26</i>
	<p>Water level is too high.</p> <ul style="list-style-type: none"> ▶ Select a suitable program for draining. <ul style="list-style-type: none"> → <i>"Programs", Page 21</i>
	<p>Power failure.</p> <ul style="list-style-type: none"> ▶ Open the door using the emergency release. <ul style="list-style-type: none"> → <i>"Emergency release", Page 42</i>
The water is not being pumped out.	<p>Drain pipe or water outlet hose is blocked.</p> <ul style="list-style-type: none"> ▶ Clean the drain pipe and the water outlet hose.
	<p>Drain pipe or water outlet hose is kinked or trapped.</p> <ul style="list-style-type: none"> ▶ Ensure that the drain pipe and water outlet hose are not kinked or trapped.
	<p>Drain pump is blocked.</p> <ul style="list-style-type: none"> ▶ Clean the drain pump. → <i>Page 31</i>
	<p>The water outlet hose is connected too high.</p> <ul style="list-style-type: none"> ▶ Install the water outlet hose at a maximum height of 39 in. (1 meter).
	<p>Pump cap is not correctly assembled.</p> <ul style="list-style-type: none"> ▶ Correctly assemble the pump cover.
	<p>Detergent dosage is too high.</p> <ul style="list-style-type: none"> ▶ Immediate measure: Mix one tablespoon of fabric softener with 0.5 US quarts (0.5 liters) of water and pour the mixture into the compartment for manual dosing (not for outdoor clothing, sportswear or items stuffed with down). ▶ If intelligent dosing is activated, reduce the basic dosage. → <i>Page 27</i> ▶ If you dose manually, reduce the amount of detergent for the next washing cycle with the same load.
	<p>Unapproved extension installed on the water outlet hose.</p> <ul style="list-style-type: none"> ▶ Remove any unapproved extensions from the water outlet hose. <ul style="list-style-type: none"> → <i>"Connecting the appliance", Page 11</i>
	<p>The pump cap is not fully screwed in.</p> <ul style="list-style-type: none"> ▶ Ensure that the pump cap is screwed in all the way into the appliance. The handle on the pump cap must be in a vertical position.
Water is not flowing in. Detergent is not being dispensed.	<p>II ▶ has not been pressed.</p> <ul style="list-style-type: none"> ▶ Press II ▶.
	<p>The filters in the water inlet are blocked.</p>

Issue	Cause and troubleshooting
Water is not flowing in. Detergent is not being dispensed.	<p>▶ Clean the filters in the water inflow.</p> <hr/> <p>Faucet is turned off.</p> <p>▶ Turn on the faucet.</p> <hr/> <p>The water inlet hose is kinked or jammed.</p> <p>▶ Ensure that the water inlet hose is not kinked or jammed.</p>
Drum starts rotating briefly several times.	<p>The unbalanced load detection system eliminates an imbalance by repeatedly redistributing the laundry.</p> <p>▶ Not a fault – no action required.</p> <p>Note: When loading, where possible, place large and small items of laundry together in the drum. Laundry items of different size distribute themselves better during the spin cycle.</p>
The program duration changes during the wash cycle.	<p>The program operation is optimized electronically. This may change the program duration.</p> <p>▶ Not a fault – no action required.</p> <hr/> <p>The unbalanced load detection system eliminates an imbalance by repeatedly redistributing the laundry.</p> <p>▶ Not a fault – no action required.</p> <p>Note: When loading, where possible, place large and small items of laundry together in the drum. Laundry items of different size distribute themselves better during the spin cycle.</p> <hr/> <p>Foam detection system switches on a rinse cycle if foam build-up is too high.</p> <p>▶ Not a fault – no action required.</p>
There is no water visible in the drum.	<p>Water is below the visible area.</p> <p>▶ Not a fault – no action required.</p> <p>▶ Do not add any extra water to the appliance while it is operating.</p>
Drum jerks after the program starts.	<p>This is caused by an internal motor test.</p> <p>▶ Not a fault – no action required.</p>
Vibrations and movement of the appliance whilst spinning.	<p>Appliance is not correctly aligned.</p> <p>▶ → <i>"Aligning the appliance", Page 12</i></p> <hr/> <p>The appliance feet are not fixed.</p> <p>▶ Secure the appliance feet. → <i>"Aligning the appliance", Page 12</i></p> <hr/> <p>Transit bolts have not been removed.</p> <p>▶ → <i>"Removing the transit bolts", Page 10.</i></p>
Drum rotates, water does not flow in.	<p>Load detection is active.</p> <p>▶ Not a fault – no action required.</p> <p>Note: The load detection can take up to 2 minutes.</p>
Heavy foam build-up.	<p>Detergent dosage is too high.</p> <p>▶ Immediate measure: Mix one tablespoon of fabric softener with 0.5 US quarts (0.5 liters) of water and pour the mixture into the compartment for manual dosing (not for outdoor clothing, sportswear or items stuffed with down).</p> <p>▶ If intelligent dosing is activated, reduce the basic dosage. → <i>Page 27</i></p> <p>▶ If you dose manually, reduce the amount of detergent for the next washing cycle with the same load.</p>
i-DOS 1 i-DOS 2 cannot be pressed.	<p>Intelligent dosing is not intended for this program.</p> <p>▶ Use the manual dosing compartment. → <i>Page 27</i></p> <hr/> <p>Program progress does not allow intelligent dosing. No remedial action possible.</p>

Issue	Cause and troubleshooting
High spin speed not reached.	<p>A low spin speed is selected.</p> <ul style="list-style-type: none"> ▶ The next time you run a wash cycle, set a higher spin speed. <p>Unbalance load detection system is using a reduced spin speed to eliminate an unbalance.</p> <ul style="list-style-type: none"> ▶ Redistribute the laundry in the drum. <p>Note: Where possible, mix large and small items in the drum. Laundry items of different size distribute themselves better during the spin cycle.</p> <ul style="list-style-type: none"> ▶ Start the Spin program.
The spin program does not start.	<p>Drain pipe or water outlet hose is blocked.</p> <ul style="list-style-type: none"> ▶ Clean the drain pipe and the water outlet hose. <p>Drain pipe or water outlet hose is kinked or trapped.</p> <ul style="list-style-type: none"> ▶ Ensure that the drain pipe and water outlet hose are not kinked or trapped. <p>The unbalanced load detection system has interrupted the spin cycle because the laundry is unevenly distributed.</p> <ul style="list-style-type: none"> ▶ Redistribute the laundry in the drum. <p>Note: Where possible, mix large and small items in the drum. Laundry items of different size distribute themselves better during the spin cycle.</p> <ul style="list-style-type: none"> ▶ Start the Spin program.
Rushing, hissing noise.	<p>Water is flushed under pressure into the detergent drawer.</p> <ul style="list-style-type: none"> ▶ Not a fault – normal operating noise.
Longer, whirring noise before the start of the wash cycle or fabric softening.	<p>Intelligent dosing system dispenses detergent or care products.</p> <ul style="list-style-type: none"> ▶ Not a fault – normal operating noise.
Brief whirring noise after switching on the appliance.	<p>Intelligent dosing system carries out a function test.</p> <ul style="list-style-type: none"> ▶ Not a fault – normal operating noise.
Loud noises during the spin cycle.	<p>Appliance is not correctly aligned.</p> <ul style="list-style-type: none"> ▶ → <i>"Aligning the appliance", Page 12</i> <p>The appliance feet are not fixed.</p> <ul style="list-style-type: none"> ▶ Secure the appliance feet. → <i>"Aligning the appliance", Page 12</i> <p>Transit bolts have not been removed.</p> <ul style="list-style-type: none"> ▶ → <i>"Removing the transit bolts", Page 10.</i>
Banging noises, rattling in the drain pump.	<p>Foreign bodies have got into the drain pump.</p> <ul style="list-style-type: none"> ▶ → <i>"Cleaning the drain pump", Page 31.</i>
Slurping, rhythmical suction noise.	<p>The drain pump is active, the detergent solution is pumped out.</p> <ul style="list-style-type: none"> ▶ Not a fault – normal operating noise.
Creasing.	<p>The spin speed is too high.</p> <ul style="list-style-type: none"> ▶ The next time you run a wash cycle, set a lower spin speed. <p>The load is too large.</p> <ul style="list-style-type: none"> ▶ The next time you run a wash cycle, reduce the amount of laundry being loaded. <p>Unsuitable program for the type of fabric.</p> <ul style="list-style-type: none"> ▶ Select the programs that are suitable for the type of fabric.
The spin result is not satisfactory. The laundry is too wet/too damp.	<p>A low spin speed is selected.</p> <ul style="list-style-type: none"> ▶ The next time you run a wash cycle, set a higher spin speed. ▶ Start the Spin program. <p>Drain pipe or water outlet hose is blocked.</p> <ul style="list-style-type: none"> ▶ Clean the drain pipe and the water outlet hose.

Issue	Cause and troubleshooting
<p>The spin result is not satisfactory. The laundry is too wet/too damp.</p>	<p>Drain pipe or water outlet hose is kinked or trapped.</p> <ul style="list-style-type: none"> ▶ Ensure that the drain pipe and water outlet hose are not kinked or trapped. <hr/> <p>The unbalanced load detection system has interrupted the spin cycle because the laundry is unevenly distributed.</p> <ul style="list-style-type: none"> ▶ Redistribute the laundry in the drum. <p>Note: Where possible, mix large and small items in the drum. Laundry items of different size distribute themselves better during the spin cycle.</p> <ul style="list-style-type: none"> ▶ Start the Spin program. <hr/> <p>Unbalance load detection system is using a reduced spin speed to eliminate an unbalance.</p> <ul style="list-style-type: none"> ▶ Redistribute the laundry in the drum. <p>Note: Where possible, mix large and small items in the drum. Laundry items of different size distribute themselves better during the spin cycle.</p> <ul style="list-style-type: none"> ▶ Start the Spin program.
<p>Detergent residue on the damp washing.</p>	<p>Detergents may contain water-insoluble substances that deposit on the laundry.</p> <ul style="list-style-type: none"> ▶ Start the Rinse program. <hr/> <p>Unsuitable detergent added to the dispenser of the intelligent dosing system.</p> <ol style="list-style-type: none"> 1. Check whether the detergent used is suitable. → <i>"Detergents and care products", Page 24</i> 2. Drain the dispenser. → <i>"Cleaning the detergent drawer", Page 29</i> 3. Clean the dispenser. 4. Refill the dispenser. → <i>"Pouring liquid detergent and fabric softener into the dispensers", Page 26</i> <hr/> <p>Basic dosage not adjusted.</p> <ul style="list-style-type: none"> ▶ If intelligent dosing is activated, reduce the basic dosage. → <i>Page 27</i>
<p>Detergent residue on the dry laundry.</p>	<p>Detergents may contain water-insoluble substances that deposit on the laundry.</p> <ul style="list-style-type: none"> ▶ Brush out the laundry after washing and drying. <hr/> <p>Unsuitable detergent added to the dispenser of the intelligent dosing system.</p> <ol style="list-style-type: none"> 1. Check whether the detergent used is suitable. → <i>"Detergents and care products", Page 24</i> 2. Drain the dispenser. → <i>"Cleaning the detergent drawer", Page 29</i> 3. Clean the dispenser. 4. Refill the dispenser. → <i>"Pouring liquid detergent and fabric softener into the dispensers", Page 26</i> <hr/> <p>Basic dosage not adjusted.</p> <ul style="list-style-type: none"> ▶ If intelligent dosing is activated, reduce the basic dosage. → <i>Page 27</i>
<p>Insufficient cleaning.</p>	<p>Basic dosage not adjusted.</p> <ul style="list-style-type: none"> ▶ If intelligent dosing is activated, adjust the basic dosage. → <i>Page 27</i> <hr/> <p>Detergent or care products have congealed in dispensers of the intelligent dosing system.</p> <ol style="list-style-type: none"> 1. Check whether the detergent used is suitable. → <i>"Detergents and care products", Page 24</i> 2. Drain the dispenser. → <i>"Cleaning the detergent drawer", Page 29</i> 3. Clean the dispenser. 4. Refill the dispenser. → <i>"Pouring liquid detergent and fabric softener into the dispensers", Page 26</i>

Issue	Cause and troubleshooting
Insufficient cleaning.	Unsuitable detergent added to the dispenser of the intelligent dosing system. <ol style="list-style-type: none"> 1. Check whether the detergent used is suitable. → <i>"Detergents and care products", Page 24</i> 2. Drain the dispenser. → <i>"Cleaning the detergent drawer", Page 29</i> 3. Clean the dispenser. 4. Refill the dispenser. → <i>"Pouring liquid detergent and fabric softener into the dispensers", Page 26</i>
Home Connect® is not working properly.	Various causes are possible. <ul style="list-style-type: none"> ▶ Go to www.home-connect.com.
No connection to the home network.	Wi-Fi is switched off. <ul style="list-style-type: none"> ▶ Activating Wi-Fi on the appliance. → <i>"Activating Wi-Fi on the appliance", Page 28.</i> <hr/> Wi-Fi is activated but a connection to your home network cannot be established. <ol style="list-style-type: none"> 1. Ensure that the home network is available. 2. Reconnect the appliance to the home network. → <i>"Setting up Home Connect®", Page 28</i>
Water is leaking out at the water inlet hose.	Water inlet hose is not correctly/securely connected. <ol style="list-style-type: none"> 1. Connect the water inlet hose correctly. → <i>"Connecting the water inlet hoses", Page 11</i> 2. Tighten the screw connection.
Water is leaking out at the water outlet hose.	The water outlet hose is damaged. <ul style="list-style-type: none"> ▶ Replace the damaged water outlet hose. <hr/> water outlet hose is not connected correctly. <ul style="list-style-type: none"> ▶ Connect the water outlet hose correctly. → <i>"Water outlet connection types", Page 11</i>
Odors have formed in the appliance.	Humidity and detergent residue may promote the formation of bacteria. <ul style="list-style-type: none"> ▶ → <i>"Cleaning the drum", Page 29</i> ▶ If you are not using the appliance, leave the door and detergent drawer open so that residual water can evaporate.
Water is leaking from below the door.	Dirt on the door or seal causes leaks. <ul style="list-style-type: none"> ▶ Clean the door and the seal.

19.1 Emergency release

Releasing the door

Requirement: The drain pump is empty. → *Page 31*

1. **NOTICE:** Escaping water may cause material damage.
 - ▶ Do not open the door if you can see water through the glass.

Pull the emergency release downwards with a tool and release.

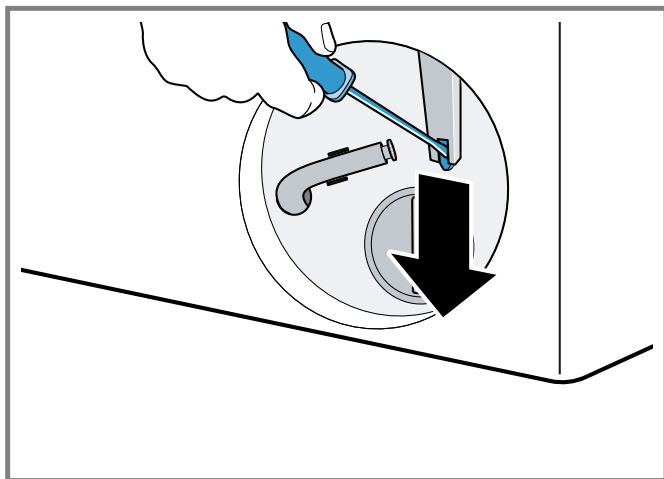

- ✓ The door lock is released.
2. Insert the service flap and lock it into place.
 3. Close the service flap.

20 Transportation, storage and disposal

20.1 Removing the appliance

1. Turn off the faucet.
2. Empty the water inlet hose.
3. Put the appliance into standby mode.
→ *"Put the appliance into standby mode", Page 26*
4. Unplug the appliance's mains plug.
5. Drain the water.
→ *"Cleaning the drain pump", Page 31*
6. Detach the hoses.
7. Empty the dispensers.

20.2 Inserting the transit bolts

Secure the appliance before transportation using transit bolts in order to prevent transport damage.

1. Use a screwdriver to remove the 4 cover caps.

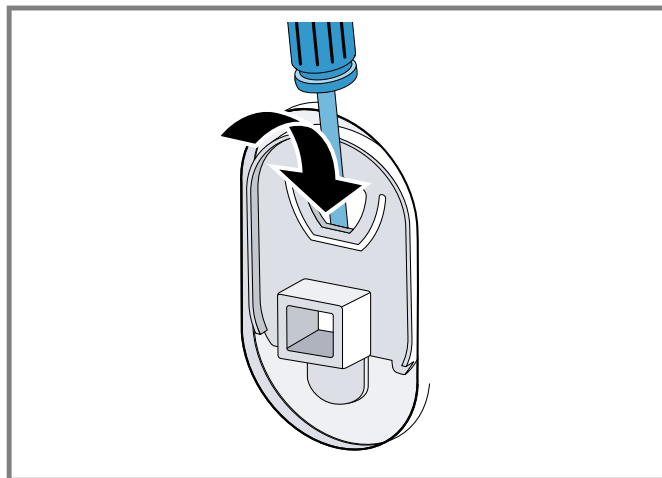

- Keep the cover caps.
2. Insert the 4 transit bolts.
→ *"Removing the transit bolts", Page 10*

20.3 Using the appliance again

- ▶ For further information, see
→ *"Installation and connection", Page 9* and
→ *"Starting an empty washing cycle", Page 12.*

20.4 Disposal of your old appliance

Environmentally compatible disposal allows valuable raw materials to be recycled.

⚠ WARNING

Children can lock themselves in the appliance, thereby putting their lives at risk.

- ▶ Do not install the appliance behind a door as this may obstruct the appliance door or prevent it from opening.
- ▶ With redundant appliances, pull out the mains plug of the power cord, cut through the power cord and remove the appliance door.

1. Unplug the appliance from the power supply.
2. Cut through the power cord.
3. Remove the appliance door.
4. Dispose of the appliance in an environmentally responsible manner.

Information about current disposal methods can be obtained from your specialist dealer or local authority.

21 Customer Service

With any warranty repair, we will make sure your appliance is repaired by an authorized service provider using genuine replacement parts. We use only genuine replacement parts for all repairs.

Detailed information on the warranty period and terms of warranty can be found in the Statement of Limited Product Warranty, from your retailer, or on our website.

If you contact Customer Service, you will need the model number (E-Nr.), the production number (FD) and the consecutive numbering (Z-Nr.) of your appliance.

USA:

1-800-944-2904

www.bosch-home.com/us/owner-support/get-support

www.bosch-home.com/us/shop

CA:

1-800-944-2904

www.bosch-home.ca/en/service/get-support

www.bosch-home.ca/en/service/cleaners-and-accessories

For assistance with connecting to Home Connect®, you can also view instructions here:

www.home-connect.com/us/en/help-support/set-up

21.1 Model number (E-Nr.), production number (FD) and consecutive numbering (Z-Nr.)

You can find the model number (E-Nr.), the production number (FD) and the consecutive numbering (Z-Nr.) on the appliance's rating plate.

Depending on the model, the rating plate can be found:

- on the inside of the door.
- on the inside of the service flap.
- on the backside of the appliance.

Making a note of your appliance's details and the Customer Service telephone number will enable you to find them again quickly.

22 Technical specifications

Weight	106.9 lbs (82.6 kg)
Drum volume	2.4 ft ³
Mains voltage	208-240 V, 60 Hz
⇌ Minimum installation protection	10,5 A
Power rating	2300 W
Water pressure	<ul style="list-style-type: none"> ■ Minimum: 14.5 psi (100 kPa) ■ Maximum: 145 psi (1000 kPa)
Length of the water inlet hose	47" (119.4 cm)
Length of the water drain hose	57" (144.8 cm)
Length of the power cord	64 ⁷ / ₈ " (165 cm)

Appliance dimensions

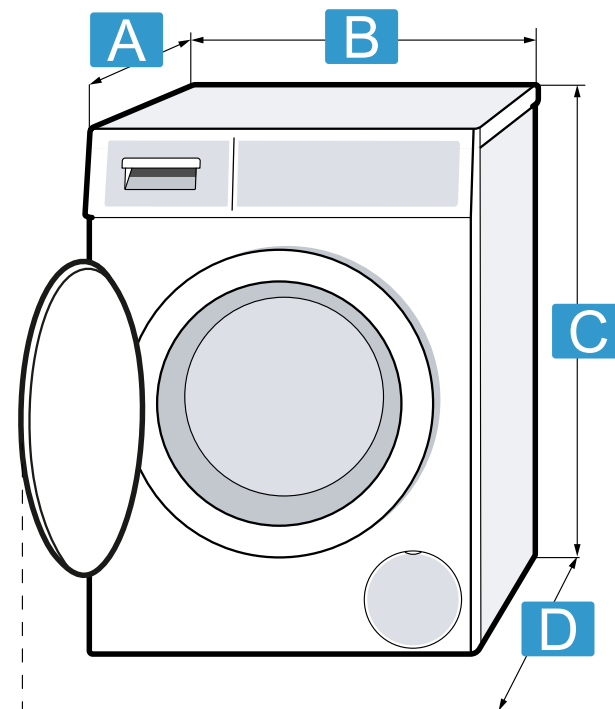

A	Appliance depth: 23 1/4" (59.0 cm) Appliance depth with door closed: 25 1/2" (64.8 cm)
B	Appliance width: 23 1/2" (59.8 cm)
C	Appliance height ¹ : 33 1/4" (84.5 cm)
D	Appliance depth with door open: 43" (109.0 cm)

¹ When aligning the appliance, the appliance height may increase by up to 1/2" (1.2 cm).



A series of horizontal lines for writing, starting from the top line below the icon and extending to the bottom of the page.



A series of horizontal lines spanning the width of the page, providing a template for writing. The lines are evenly spaced and extend from the left margin to the right edge of the page.



Register your appliance to enjoy customized benefits.

Thank you for being a Bosch customer!
Simply create a MyBosch account, then register your appliance.
You'll find a variety of customized information in MyBosch such as:

- **Discounts for filters, cleaners, accessories & parts**
- **Easy access to manuals & appliance specifications**
- **Easy access to part lists**
- **Customized offer for the Bosch Appliance Service Plan (sent by mail after appliance registration)**

Register here:
www.bosch-home.com/us/owner-support/mybosch

BOSCH
HOME APPLIANCES
SERVICE

Looking for help? You'll find it here.

No matter what, no matter when: Bosch is here to support you.
We're here to assist with usage instructions, cleaning tips,
accessories & parts, troubleshooting, and repairs.
Find online resources such as FAQs, how-to-videos, manuals,
warranties and authorized Bosch servicers at:
www.bosch-home.com/us/owner-support/get-support

Contact us:
Please have your Model Number (E-Nr) ready when contacting us.
1-800-944-2904
www.bosch-home.com/us/owner-support/contact-us

BSH Home Appliances Corporation
1901 Main Street, Suite 600
Irvine, CA 92614
USA
www.bosch-home.com
1-800-944-2904
© 2024 BSH Home Appliances Corporation



9001853079 (040215)

en-us