

BS 470/471 612,

BS 474/475 612,

BS 484/485 612

Combination steam oven

Table of contents

1 IMPORTANT SAFETY INSTRUCTIONS.....	4	8.6 Cooking time	19
1.1 Safety definitions.....	4	8.7 Cooking time end	20
1.2 General information.....	4	9 Long-term timer.....	20
1.3 Safe use.....	4	9.1 Starting the long-term timer	20
1.4 Child safety	6	9.2 Switching off the long-term timer	20
1.5 Steam cooking	6	10 Child lock.....	20
1.6 Cleaning function	7	10.1 Activating the childproof lock	20
1.7 Proper installation and maintenance	7	10.2 Deactivating the childproof lock	20
1.8 State of California Proposition 65 Warnings	7	11 Automatic programs	21
2 Preventing material damage	8	11.1 Information about the settings for the automatic programs.....	21
2.1 General information.....	8	11.2 Setting the food	21
2.2 Steam	8	11.3 Calling up the last automatic programs used	21
2.3 Core temperature probe	8	12 Individual recipes.....	22
2.4 Cleaning.....	9	12.1 Recording a recipe	22
3 Environmental protection and energy-saving	9	12.2 Programming a recipe	22
3.1 Disposal of packaging	9	12.3 Entering a name	22
3.2 Saving energy	9	12.4 Starting a recipe	22
4 Familiarizing yourself with your appliance	9	12.5 Changing a recipe	23
4.1 Appliance	9	12.6 Deleting a recipe	23
4.2 Automatic door opening	13	13 Core temperature sensor.....	23
4.3 Standby.....	13	13.1 Estimated cooking time	23
4.4 Additional information.....	14	13.2 Core temperature guideline values.....	24
4.5 Cooling fan.....	14	13.3 Inserting the core temperature probe into the food.....	24
4.6 Drying the oven cavity.....	14	13.4 Turning the food	25
4.7 Automatic switch-off	14	13.5 Setting the core temperature probe	25
5 Accessories.....	15	14 Home Connect®	26
5.1 Other accessories	15	14.1 Setting up the Home Connect® app	26
5.2 Locking function	16	14.2 Setting up Home Connect®.....	26
5.3 Sliding accessories into the oven cavity	16	14.3 Home Connect® settings	26
6 Before using for the first time	16	14.4 Data Protection	27
6.1 Initial use.....	16	15 Basic settings.....	28
7 Basic Operation	17	15.1 Overview of the basic settings.....	28
7.1 Activating the appliance	17	15.2 Changing the basic settings	30
7.2 Opening the appliance door	17	16 Cleaning and maintenance.....	30
7.3 Switching on the appliance.....	17	16.1 Cleaning agents	30
7.4 Switching off the appliance.....	17	16.2 Microfiber cloth.....	32
7.5 Steam injection	17	16.3 Cleaning the drain filter	32
7.6 Steam removal.....	18	16.4 Cleaning program.....	32
7.7 After each use.....	18	16.5 Drying program	34
7.8 Switching on the appliance after automatic switch- off.....	18	16.6 Descaling program	35
8 Timer functions.....	18	16.7 Removing the shelf supports	36
8.1 Overview of the timer functions	18	16.8 Fitting the shelf supports	36
8.2 Calling up the timer menu	18	17 Troubleshooting.....	37
8.3 Exiting the timer menu	18	18 Disposal.....	39
8.4 Short-term timer	19	18.1 Disposal of your old appliance.....	39
8.5 Stopwatch	19		

19 Customer Service	40
19.1 Model number (E-Nr.) and production number (FD)	40
19.2 Rating plate location.....	40
20 STATEMENT OF LIMITED PRODUCT WARRANTY	40
20.1 What this warranty covers & Who it applies to.....	40
20.2 How long the warranty lasts	40
20.3 Repair/replace as your exclusive remedy.....	41
20.4 Out of warranty product.....	41
20.5 Warranty exclusions.....	41
20.6 Obtaining warranty service.....	42
20.7 Product information	42



IMPORTANT SAFETY INSTRUCTIONS

READ AND SAVE THESE INSTRUCTIONS

Read all of the instructions carefully before using the appliance. In order to reduce the risk of fire, electric shocks and personal injuries when using the appliance, follow the basic safety precautions, including the following safety instructions.

1.1 Safety definitions

Here you can find explanations of the safety signal words used in this manual.

WARNING

This indicates that death or serious injuries may occur as a result of non-observance of this warning.

CAUTION

This indicates that minor or moderate injuries may occur as a result of non-observance of this warning.

NOTICE:

This indicates that damage to the appliance or property may occur as a result of non-compliance with this advisory.

Note: This alerts you to important information and/or tips.

1.2 General information

Here you can find general information about this manual.

- Please read this manual carefully.
- Observe the safety instructions and warnings.
- Keep the manual and the product information in a safe place for future reference or for the next owner.
- Check the appliance for damage after unpacking it. Do not connect the appliance if it has been damaged in transit.

This appliance is intended for use up to a maximum height of 13,100 feet (4000 meters) above sea level.

1.3 Safe use

WARNING

When properly cared for, your new appliance has been designed to be safe and reliable.

- ▶ Read all instructions carefully before use. These precautions will reduce the risk of burns, electric shock, fire, and injury to persons.
- ▶ When using kitchen appliances, basic safety precautions must be followed, including those in the following pages.

WARNING

If materials inside an oven or warming drawer should ignite, keep door closed.

- ▶ Turn off the appliance and disconnect the circuit at the circuit breaker box.

A fire could occur during cooking.

- ▶ Always have a working smoke detector near the kitchen.
- ▶ Have an appropriate fire extinguisher available, nearby, highly visible and easily accessible near the appliance. NEVER cover any slots, holes or passages in the oven bottom or cover an entire rack with materials such as aluminum foil.
- ▶ Doing so blocks air flow through the oven.
- ▶ Aluminum foil linings may also trap heat, causing a fire hazard.

Cooking fires can spread if extinguished incorrectly.

- ▶ Never use water on cooking fires.

Wear Proper Apparel. Loose-fitting or hanging garments, such as ties, scarves, jewelry, or dangling sleeves, should never be worn while using the appliance.

- ▶ Tie long hair so that it does not hang loose.
 - ▶ Secure all loose garments, etc. before beginning.
- In the event that personal clothing or hair catches fire, drop and roll immediately to extinguish flames.
Do Not Use Water on Grease Fires.

- ▶ Smother fire or flame or use dry chemical or foam-type extinguisher.

WARNING

While cooking food items, small amounts of certain by-products, such as particulate matter / soot, can be released. To minimize exposure to these substances:

- ▶ Always ensure proper ventilation by using an appropriate ventilation fan or hood vented to the outside and/or an open window.
- ▶ Always operate the unit according to the instructions in this manual.

WARNING

Overheated materials can cause fire or burns and may produce potentially harmful smoke or fumes.

- ▶ To prevent overheating, turn ventilation hood ON when heating grease, fats or frying using medium to high heat settings.
- ▶ Avoid heating empty pots and pans.
- ▶ Do not allow pans to boil dry.



IMPORTANT SAFETY INSTRUCTIONS

READ AND SAVE THESE INSTRUCTIONS

- ▶ Do not allow aluminum foil, plastic, paper, or cloth to come in contact with a hot surface element, burner, or grate.

CAUTION

The oven vents are important for air circulation. Covering the oven vents will cause the oven to overheat. Refer to the appliance overview for the location of the oven vents.

- ▶ Do not obstruct oven vents.

WARNING

Use Only Dry Potholders - Moist or damp potholders on hot surfaces may result in burns from steam.

- ▶ Do not let potholders touch hot heating elements.
 - ▶ Do not use a towel or other bulky cloth.
- DO NOT TOUCH HEATING ELEMENTS OR INTERIOR SURFACES OF OVEN - Heating elements may be hot even though they are dark in color. Interior surfaces of an oven become hot enough to cause burns.

- ▶ During and after use, do not touch, or let clothing, potholders, or other flammable materials contact heating elements or interior surfaces of oven until they have had sufficient time to cool. Other surfaces of the appliance may become hot enough to cause burns. Among these surfaces are oven vent openings, surfaces near these openings and oven doors.

Use Care When Opening Door - Let hot air or steam escape before removing or replacing food.

- ▶ Standing to the side, open the door (or drawer) slowly and slightly to let hot air and/or steam escape.
- ▶ Keep your face clear of the opening and make sure there are no children or pets near the appliance.
- ▶ After the release of hot air and/or steam, proceed with your cooking.
- ▶ Keep doors shut unless necessary for cooking or cleaning purposes.
- ▶ Do not leave open doors unattended.

CAUTION

Use caution when cooking foods with high alcohol content (e.g. rum, brandy, bourbon) in the oven. Alcohol evaporates at high temperatures. There is a risk of burning as the alcohol vapors may catch fire in the oven.

- ▶ Use only small quantities of alcohol in foods, and open the oven door carefully.

Placement of Oven Racks - Always place oven racks in desired location while oven is cool. If the rack must be moved while the oven is hot, do not let potholders contact

the hot heating elements in the oven. Use caution when removing oven racks from the lowest rack position to avoid contact with the hot oven door.

WARNING

The oven interior and the meat probe become very hot.

- ▶ Use oven mitts to plug and unplug the meat probe.

WARNING

Storage in or on Appliance - The use of corrosive chemicals in heating or cleaning will damage the appliance and could result in injury.

- ▶ Flammable materials, corrosive chemicals, vapors or non-food products should not be stored or used in an oven or on or near surface units.
- ▶ The appliance is specifically designed for use when heating or cooking food.

This appliance is intended for normal family household use only. It is not approved for outdoor use. See the Statement of Limited Product Warranty. If you have any questions, contact the manufacturer.

WARNING

Using this appliance other than for its intended use can cause fire or injury to persons.

- ▶ Use this appliance only for its intended use as described in this manual.
- ▶ NEVER use your appliances as a space heater for warming or heating the room. Doing so may result in overheating the appliance.
- ▶ Never use the appliance for storage.

WARNING

TO REDUCE THE RISK OF INJURY TO PERSONS IN THE EVENT OF A GREASE FIRE, OBSERVE THE FOLLOWING.

- ▶ SMOTHER FLAMES with a close-fitting lid, cookie sheet, or metal tray, then turn off the burner. BE CAREFUL TO PREVENT BURNS. If the flames do not go out immediately, EVACUATE AND CALL THE FIRE DEPARTMENT.
- ▶ NEVER PICK UP A FLAMING PAN – You may be burned.
- ▶ DO NOT USE WATER, including wet dishcloths or towels – a violent steam explosion will result.
- ▶ Use an extinguisher ONLY if:
 - You know you have a Class ABC extinguisher, and you already know how to operate it.
 - The fire is small and contained in the area where it



IMPORTANT SAFETY INSTRUCTIONS

READ AND SAVE THESE INSTRUCTIONS

started.

- The fire department is being called.
- You can fight the fire with your back to an exit.

Do not heat or warm unopened food containers. Build-up of pressure may cause the container to burst and cause injury.

Failure to operate knobs properly may result in personal injury and damage to the appliance.

Cooking or roasting bags might explode.

- ▶ Follow the manufacturer's directions when using cooking or roasting bags.

CAUTION

To avoid possible injury or damage to the appliance, ensure oven rack is installed exactly per installation instructions and not backwards or upside down.

Do not place anything on the oven cavity bottom. Do not cover it with aluminum foil. A build-up of heat could damage the appliance or cause injury.

WARNING

Moisture intrusion may cause an electric shock.

- ▶ Do not use any steam cleaners or high-pressure cleaners to clean the appliance.

If the appliance or the power cord is damaged, this is dangerous.

- ▶ Do not turn the power on if the appliance or the power cord is damaged. Doing so may cause injury.
- ▶ Never operate a damaged appliance.
- ▶ Never pull on the power cord to unplug the appliance. Always unplug the appliance at the power outlet.
- ▶ Call Customer Service. → *Page 40*
- ▶ Repairs to the appliance must only be performed by an authorized service provider.

WARNING

Scratched glass in the appliance door may develop into a crack.

- ▶ Do not use any harsh or abrasive cleaners or sharp metal scrapers to clean the glass on the oven door, as they may scratch the surface.

Use of a wrong meat probe can damage the insulation.

Use only the meat probe intended for this appliance.

1.4 Child safety

This appliance is not intended for use by persons (including children) with reduced physical, sensory or mental capabilities, or lack of experience and knowledge,

unless they have been given supervision or instruction concerning use of the appliance by a person responsible for their safety.

When children become old enough to use the appliance, it is the responsibility of the parents or legal guardians to ensure that they are instructed in safe practices by qualified persons.

Children should be supervised to ensure that they do not play with the appliance.

WARNING

Do not allow children to use this appliance unless closely supervised by an adult.

- ▶ Children and pets should not be left alone or unattended in the area where the appliance is in use. They should never be allowed to play in its vicinity, whether or not the appliance is in use.

Do not allow anyone to climb, stand, lean, sit, or hang on any part of an appliance, especially a door, warming drawer, or storage drawer.

- ▶ This can damage the appliance, and the unit may tip over, potentially causing severe injury.

Do not let children play with the appliance.

CAUTION

Do not store items of interest to children in an appliance, in cabinets above an appliance or on the backguard of an appliance. Children climbing on the appliance to reach items could be seriously injured.

Do Not Leave Children Alone.

- ▶ Children should not be left alone or unattended in the area where the appliance is in use.
- ▶ They should never be allowed to sit or stand on any part of the appliance.
- ▶ Always check inside the oven before turning it on.

WARNING

To avoid the risk of suffocation:

- ▶ Do not allow children to play with packaging material.
- ▶ Store small parts safely as they can be a choke hazard.

1.5 Steam cooking

Follow these additional safety instructions when using a steam cooking mode.

CAUTION

The water in the oven cavity is hot.

- ▶ Let the oven cavity cool down before you clean the appliance.



IMPORTANT SAFETY INSTRUCTIONS

READ AND SAVE THESE INSTRUCTIONS

WARNING

Hot steam may escape when the appliance door is opened. Steam is not visible at certain temperatures!

- ▶ Open the appliance door carefully during or after cooking.
- ▶ Do not stand too near or lean over the appliance when opening the appliance door .

The water in the oven cavity becomes very hot during cooking.

- ▶ DO NOT clean the appliance immediately after switching it off.
- ▶ Wait until the appliance has cooled down.

Hot steam can leak during operation.

- ▶ Do not touch the ventilation openings.
- ▶ Keep children away.

Hot liquid may spill over the sides of cooking accessories when they are removed from the oven cavity.

- ▶ Carefully remove cooking accessories with oven mitts. Movement when opening the appliance door and when removing the cookware can cause hot liquid to spray out.
- ▶ Do not stand too close to the appliance when opening it.
- ▶ Open appliance door carefully.
- ▶ Remove cookware carefully.
- ▶ Keep children away.

1.6 Cleaning function

Follow these safety instructions when using the cleaning function.

WARNING

To prevent the cleaner from coming into contact with the skin or eyes, do not remove the locking cap from a spent cartridge.

CAUTION

To avoid injury, do not remove the wax plugs from the opening of the cleaning cartridge. Do not use any other detergents. Do not use damaged cartridges.

WARNING

Do not use a protective coating to line the oven and do not use commercial oven cleaner.
Clean only parts listed in this manual.

1.7 Proper installation and maintenance

WARNING

In the event of a malfunction, it might become necessary to turn off the power supply.

- ▶ Have the installer show you the circuit breaker or fuse. Mark it for easy reference.

To avoid electrical shock hazard, before servicing the appliance, turn power off at the service panel and lock the panel to prevent the power from being switched on accidentally.

Proper Installation - Improper installation or grounding can cause electric shock.

- ▶ This appliance must be properly installed and grounded by a qualified technician.
- ▶ Connect only to properly grounded outlet.
- ▶ Refer to installation instructions for details.

User Servicing - Do not repair or replace any part of the appliance unless specifically recommended in this manual.

- ▶ All other servicing should be referred to an authorized service provider.

WARNING

Grease and fat can ignite when heated.

- ▶ Keep the oven free from grease build up.

CAUTION

In the event of an error the display flashes and beeps continuously.

- ▶ Disconnect appliance from the power supply and call an authorized service provider.

WARNING

Malfunctions can cause injuries.

- ▶ Do not operate this appliance if it is not working properly, or if it has been damaged. Contact an authorized service provider.

1.8 State of California Proposition 65 Warnings

This product may contain a chemical known to the State of California, which can cause cancer or reproductive harm. Therefore, the packaging of your product may bear the following label as required by California:

STATE OF CALIFORNIA PROPOSITION 65 WARNING:



WARNING

Cancer and Reproductive Harm - www.P65Warnings.ca.gov

2 Preventing material damage

2.1 General information

NOTICE:

A build-up of heat could damage the appliance.

- ▶ Do not place anything directly on the oven cavity floor.
- ▶ Do not line the oven cavity floor with aluminum foil.
- ▶ Always place cookware in a perforated cooking container or on a wire rack.

The appliance may become damaged due to the use of unsuitable liquids.

- ▶ Do not use any liquids other than water.
- ▶ Only use cold, fresh tap water, softened water or non-carbonated mineral water.
- ▶ You can obtain information about your mains water from your water supplier.

Chloride and acids may damage the stainless steel surface.

- ▶ Remove any residues of salt, hot sauces, e.g. ketchup or mustard, salted food, e.g. salted roasts, or other foods containing chloride or acid immediately.

If aluminum foil comes into contact with the door pane, it could cause permanent discoloration.

- ▶ Do not allow aluminum foil in the oven cavity to come into contact with the door pane.

Fruit juice can cause permanent stains in the oven cavity.

- ▶ Always remove fruit juice immediately.
- ▶ Wipe with a damp cloth, followed by a dry cloth.

The prolonged presence of moisture in the oven cavity leads to corrosion.

- ▶ Do not keep moist food in the closed oven cavity for extended periods of time.
- ▶ Do not store food in the oven cavity.

Rusting material may lead to corrosion in the oven cavity.

- ▶ Only use original accessories in the oven cavity.
- ▶ Do not use any enameled baking trays or grill trays.
- ▶ Never use serving plates or cutlery that may rust.

Small parts that are not original may damage the appliance.

- ▶ Only use original small parts, e.g. knurled nuts.
- ▶ If necessary, order small parts from our spare parts service.

Heat can damage stainless steel cooking containers.

- ▶ Only heat stainless steel cooking containers up to 446 °C (230 °C).
- ▶ Do not use stainless steel cooking containers in the oven.

Leaving the appliance to cool down with the door open will damage the front of adjacent units over time.

- ▶ Always allow the oven cavity to cool down with the door closed after cooking at high temperatures.
- ▶ Do not trap anything in the appliance door.
- ▶ Only leave the oven cavity to dry with the door open if a lot of moisture was produced during operation.

If the seal is very dirty, the appliance door will no longer close properly during operation. The fronts of adjacent units could be damaged.

- ▶ Always keep the seal clean.
- ▶ Never operate the appliance if the seal is damaged or missing.

Sitting or placing objects on the appliance door may damage it.

- ▶ Do not place, hang or support objects on the appliance door.
- ▶ Do not place any cookware or accessories on the appliance door.

2.2 Steam

NOTICE:

Dripping liquids may damage the oven cavity.

- ▶ To catch any dripping liquids, when steaming using a perforated cooking container, always insert the unperforated cooking container underneath.

Silicone baking molds are not suitable for combined operation with steam.

- ▶ Cookware must be heat- and steam-resistant.

Using cookware with rust spots may cause corrosion in the oven cavity. Even the smallest spots of rust can cause corrosion.

- ▶ Do not use cookware with rust spots.

Hot water in the water tank may damage the steam system.

- ▶ Only fill the water tank with cold water.

If descaling solution comes into contact with the control panel or other delicate surfaces, it will damage them.

- ▶ Remove descaling solution immediately with water.

2.3 Core temperature probe

WARNING

An incorrect core temperature probe may damage the insulation.

- ▶ Only use the core temperature probe that is suitable for this appliance.

NOTICE:

Temperatures above 250 °C damage the core temperature probe.

- ▶ Only use the core temperature probe in your appliance at a maximum temperature of 230 °C.

You may damage the cable of the core temperature probe with the appliance door.

- ▶ Do not trap the cable of the core temperature probe in the appliance door.

The heat of the grill heating element may damage the core temperature probe.

- ▶ Ensure that the distance between the grill heating element and the core temperature probe and the cable of the core temperature probe is a few centimeters. In doing so, ensure that the meat can expand during the cooking process.

Moisture may damage the core temperature probe.

- ▶ Do not clean the core temperature probe in the dishwasher.

2.4 Cleaning

NOTICE:

Limescale may damage the appliance.

- ▶ Descale the appliance regularly.

Using the wrong descaler may damage the appliance.

- ▶ Only use the specified descaling tablets.

Improper care of the appliance can lead to corrosion in the oven cavity.

- ▶ Follow the care and cleaning instructions for the appliance.

→ "Cleaning and maintenance", Page 30

- ▶ Clean the oven cavity each time you use it as soon as the appliance has cooled down.

- ▶ After cleaning the oven cavity, use the drying program → Page 34 to dry it.

The descaling tablet may damage the oven cavity.

- ▶ Use the descaling tablet for the descaling program only.
- ▶ Place the descaling tablet into the water tank.
- ▶ Never place the descaling tablet in the oven cavity or heat it up in the oven cavity.

Heat may melt the cleaning cartridge and damage the oven cavity.

- ▶ Use cleaning cartridges for the cleaning program only.
- ▶ Never place cleaning cartridges in the oven cavity when it is hot or heat them up in the oven cavity.

Heat may damage the inserted cartridge.

- ▶ Never heat up the appliance if you have inserted the cartridge.

Heat damages the water tank.

- ▶ Do not dry the water tank in the hot oven cavity.

3 Environmental protection and energy-saving

3.1 Disposal of packaging

The packaging materials are environmentally compatible and can be recycled.

- ▶ Sort the individual components by type and dispose of them separately.

3.2 Saving energy

If you follow these instructions, your appliance will use less power.

When steaming, you can cook on several levels at the same time.

- ✓ With steam, various dishes can be prepared at the same time without the different flavors mixing. When preparing dishes with different cooking times, those with the longest cooking time should be placed in the oven first.

When cooking multiple dishes, do so in succession or in parallel.

- ✓ The oven cavity is heated after cooking the first dish. This reduces the cooking time for the following dishes.

If the cooking time is relatively long, you can switch the appliance off 10 minutes before the cooking time ends.

- ✓ There will be enough residual heat to finish cooking the dish.

Use dark-colored, black-coated or enameled baking tins.

- ✓ These types of baking tin absorb the heat particularly well.

Open the appliance door as little as possible during operation.

- ✓ This maintains the temperature in the oven cavity and eliminates the need for the appliance to reheat.

Remove any accessories that are not being used from the oven cavity.

- ✓ Accessories that are not being used do not need to be heated.

Allow frozen food to defrost before cooking.

- ✓ This saves the energy that would otherwise be required to defrost it.

4 Familiarizing yourself with your appliance

This Use and Care Manual covers several models. Your model may have some but not all of the features listed.

4.1 Appliance

Here you can find an overview of the parts of your appliance.

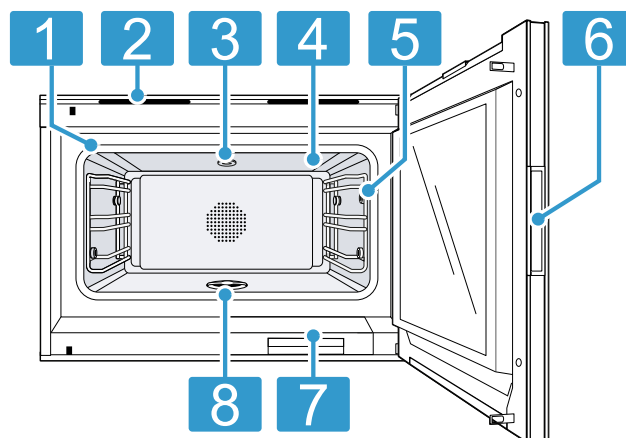

1 Door seal

2 Ventilation slots

- 3** Socket for cleaning cartridge
- 4** Glass ceramic grilling surface
- 5** Connection socket for core temperature probe
→ Page 23
- 6** Recessed door handle
- 7** Water tank for descaling program
- 8** Drain filter

Oven cavity

The cooking compartment has three shelf levels. Count the shelf levels from the bottom up.

NOTICE:

A build-up of heat could damage the appliance.

- ▶ Ensure that the oven cavity floor always remains clear.
- ▶ Do not place anything directly on the oven cavity floor.
- ▶ Do not line the oven cavity floor with aluminum foil.
- ▶ Always place cookware in the perforated cooking container or on the wire rack.

The accessories may tip.

- ▶ Do not push the accessories between the shelf positions.

When steaming, defrosting, dough proving and reheating, you can use up to three shelf levels at a time. You can only bake on one level. Use level 2 for baking or, for taller baking tins, use level 1. For very small baked goods, you can also use two levels, e.g. level 1 and level 3.

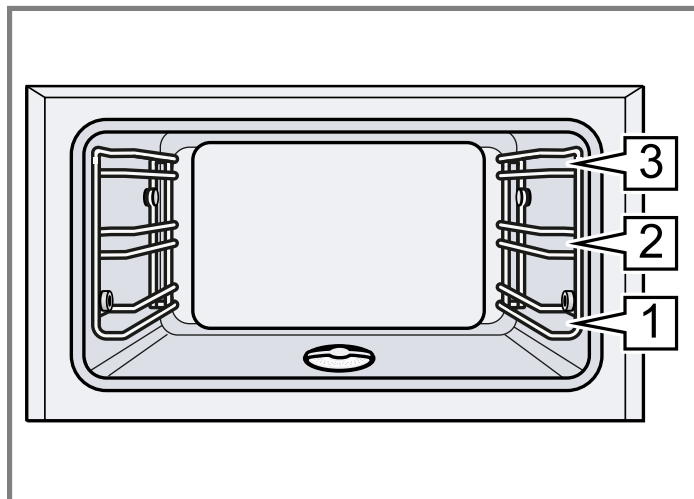

1	Touch fields	These areas are touch-sensitive. Touch a symbol to select the corresponding function.
2	Display	The display shows current settings and selection options, for example.
3	Rotary selector	Use the rotary selector to select the temperature and change additional settings.
4	Function selector	Use the function selector to select the type of heating, cleaning or the basic settings.

Symbols

Use the symbols to start or stop functions, or to navigate in the menu.

Water tank for descaling program

Your appliance is equipped with a water tank with a maximum capacity of 1.7 liters.

If you open the appliance door, you can see the water tank for the descaling program → Page 35. You can remove the lid for cleaning.

Controls

You can use the control panel to configure all functions of your appliance and to obtain information about the operating status.

On certain models, specific details such as color and shape may differ from those pictured.

Depending on the appliance variant, the function selector and rotary selector are above or below the display.

All appliance types are operated in an identical manner.

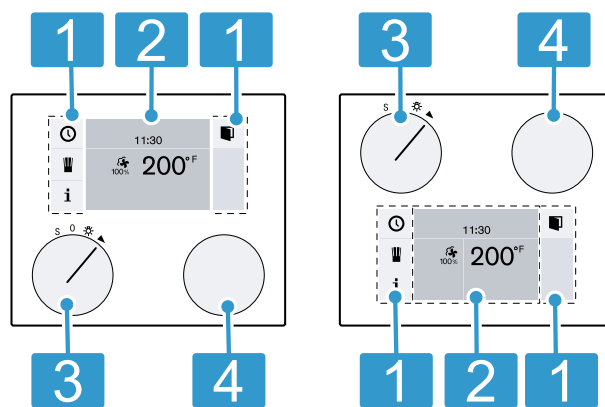

Symbol	Function
▶	Start
■	Stop

Symbol	Function
	Pause or end
X	Cancel
C	Delete
✓	Confirm or save settings
>	Selection arrow
🚪	Open the appliance door
i	Call up additional information
i [Ⓢ]	Call up important information and prompts indicating that an action is required
>>	Quick heat with status display
🍷	Calling up the automatic programs Calling up individual recipes
rec	Record menu
🔧	Edit settings
> A ^Ä	Enter a name
✕	Delete letters
🔒	Childproof lock
🕒	Call up the timer menu
🕒	Call up the long-term timer
🔪	Demo mode
🔪	Core temperature probe → <i>Page 23</i>
🚿	Start steam injection
🚿	End steam injection
🚿	Start steam removal
🚿	Stop steam removal

Symbol	Function
📶	Network connection (Home Connect®)

Colors

The different colors are used to guide the user in the relevant setting situations.

Orange	<ul style="list-style-type: none"> ▪ Initial settings ▪ Main functions
Blue	<ul style="list-style-type: none"> ▪ Basic settings ▪ Cleaning
White	<ul style="list-style-type: none"> ▪ Adjustable values

Appearance

Depending on the situation, the appearance of symbols, values or the entire display changes.

Zoom	<p>The appliance zooms in on the setting that you have just changed.</p> <p>If you have set a time and it is about to run out, it will appear larger on the display just before it runs out, e.g. if you have set the timer.</p>
------	--







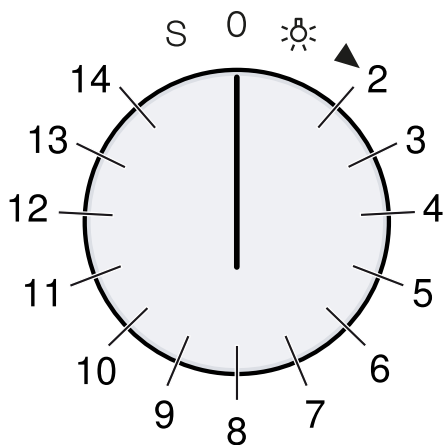



Pared-down display	<p>After a short while, the appliance reduces the amount of information shown on the display and only the most important information remains. This function is preset. You can change the setting in the basic settings.</p>
--------------------	--









Position of the function selector

Use the function selector to select the functions or types of heating.





Position	Function/type of heating	Temperature	Application
0	Zero setting		

Position	Function/type of heating	Temperature	Application
	Light		Switch on the interior lighting Access to other functions, e.g. automatic programs, individual recipes, remote start via Home Connect®
2	 Hot air + 100% humidity	85-445 °F (30-230 °C) Default temperature 210 °F (100 °C)	Steaming at 160-210 °F (70-100 °C): For vegetables, fish and side dishes The food is completely surrounded by steam. Combi-operation at 250-445 °F (120-230 °C): For puff pastry, bread and bread rolls The appliance combines hot air and steam.
3	 Hot air + 80% humidity	85-445 °F (30-230 °C) Default temperature 340 °F (170 °C)	Combi-operation: For puff pastry, meat and poultry The appliance combines hot air and steam.
4	 Hot air + 60% humidity	85-445 °F (30-230 °C) Default temperature 340 °F (170 °C)	Combi-operation: For yeast-risen dough and bread The appliance combines hot air and steam.
5	 Hot air + 30% humidity	85-445 °F (30-230 °C) Default temperature 340 °F (170 °C)	Cooking without added liquid: For pastries With this setting, the appliance does not generate any steam. Any moisture escaping from the food remains in the oven cavity and prevents the food from drying out.
6	 Hot air + 0% humidity	85-445 °F (30-230 °C) Default temperature 340 °F (170 °C)	Hot air: For cakes, cookies and bakes The fan in the back panel of the oven distributes the heat evenly throughout the oven cavity.
7	 Low-temperature cooking	85-195 °F (30-90 °C) Default temperature 160 °F (70 °C)	Low-temperature cooking for meat Gentle slow cooking for a particularly tender result
8	 Sous-vide cooking	120-200 °F (50-95 °C) Default temperature 140 °F (60 °C)	Cooking food in a vacuum at low temperatures between 120-200 °F (50-95 °C) and with 100% steam: Suitable for meat, fish, vegetables and desserts A vacuum-sealing machine uses heat to hermetically seal the food in a special heat-resistant cooking bag. The protective envelope retains the nutrients and flavors.
9	 Full surface grill level 1 + humidity	85-445 °F (30-230 °C) Default temperature 340 °F (170 °C)	Grill mode with humidity: For bakes and gratins
10	 Full surface grill level 2 + humidity	85-445 °F (30-230 °C) Default temperature 340 °F (170 °C)	Grill mode with humidity: For stuffed vegetables The grill output is increased.

Position	Function/type of heating	Temperature	Application
11	 Full surface grill + air recirculation	85-445 °F (30-230 °C) Default temperature 445 °F (230 °C)	For au gratin dishes at the end of the cooking time at 230 °C. For grilling vegetable skewers and shrimp skewers at 180 °C.
12	 Dough proving	85-120 °F (30-50 °C) Default temperature 100 °F (38 °C)	Proving: For yeast dough and sour dough Dough will rise considerably more quickly than at room temperature. Hot air and steam are combined so that the surface of the dough does not dry out. The optimal temperature setting for yeast dough is 100 °F (38 °C).
13	 Defrosting	105-140 °F (40-60 °C) Default temperature 115 °F (45 °C)	For vegetables, meat, fish and fruit The appliance uses the moisture to gently transfer the heat to the food. The food does not dry out or lose its shape.
14	 Reheating	140-355 °F (60-180 °C) Default temperature 250 °F (120 °C)	For cooked food and baked goods For gently reheating cooked food. The steam ensures that the food does not dry out. Reheat plated meals at 250 °F (120 °C) and baked goods at 355 °F (180 °C).
S	 Basic settings		Adapt the appliance to individual requirements in the basic settings → <i>Page 28</i>
S	 Cleaning program		Use the cleaning program → <i>Page 32</i> to remove stubborn dirt from the oven cavity
S	 Drying program		Use the drying program → <i>Page 34</i> to dry the oven cavity quickly, e.g. after cleaning
S	 Descaling program		Use the descaling program → <i>Page 35</i> to remove limescale from the appliance

4.2 Automatic door opening

Press  and the appliance opens the door. Use the recessed grip on the side of the oven to open the appliance door fully.

If the childproof lock is activated, press and hold  for a few seconds until the appliance opens the door.

In the event of a power failure, the automatic door opening does not work. You can open the door by hand using the recessed grip on the side.

4.3 Standby

The appliance switches to standby mode if no function is set or the childproof lock is activated. The standby screen appears if you do not implement any settings for a long time.

Different things can be displayed in standby mode. The GAGGENAU logo and the time are preset.

In standby mode, the brightness of the control panel is reduced. The brightness of the display depends on the vertical viewing angle. You can change the display and the brightness at any time in the basic settings → *Page 28*.

When "Off" is selected for the standby screen in the basic settings, you must turn the function selector to exit standby mode.

When the door is open, the interior lighting switches off after a short time.

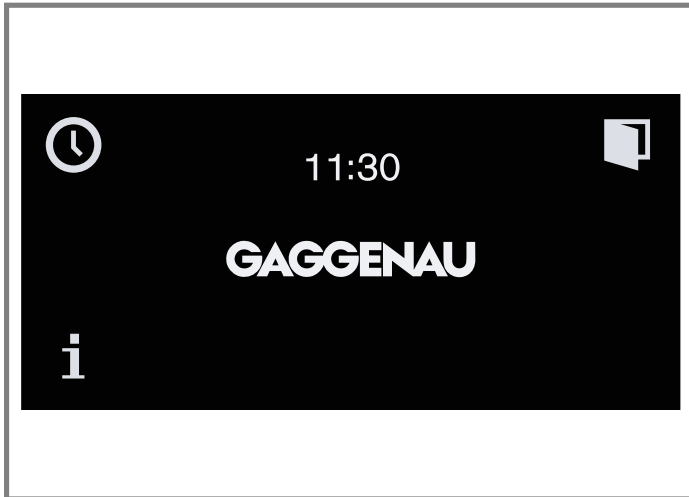

4.4 Additional information

Press **i** to display additional information, e.g. information about the type of heating that is set or the current oven cavity temperature.

During continuous operation after heating up, slight temperature fluctuations are normal.

The appliance displays the **i**[Ⓢ] symbol for important information and indicates that an action is required. The appliance also occasionally displays important information about safety and the operating status automatically. These messages disappear automatically after a few seconds, or press **✓** to confirm the message.

For messages about Home Connect®, the appliance also displays the Home Connect® status in the **i**[Ⓢ] symbol.

→ "Home Connect®", Page 26

4.5 Cooling fan

The cooling fan switches on when the appliance is in operation. The hot air escapes above the door.

After removing your food from the appliance, keep the door closed until the appliance has cooled down. The appliance door must not be left half open as this may damage adjacent kitchen units. The cooling fan continues running for a certain period of time after the appliance has stopped heating and then it switches itself off automatically.

Do not cover the ventilation slots. Otherwise, the appliance may overheat.

4.6 Drying the oven cavity

After operation with a steam function, the oven cavity is damp. The cooling fan and the fan wheel on the back wall of the oven cavity continue to run for a while after the appliance is switched off and then they switch off automatically.

The process of drying the oven cavity may take up to 95 minutes. Keep the appliance door closed while the oven cavity is being dried.

4.7 Automatic switch-off

For your protection, the appliance is equipped with an automatic switch-off function. The appliance switches off any heating process after 12 hours if the appliance controls are not used during this time. The display shows a message.



When programming with the long-term timer, the appliance does not activate the automatic switch-off function.

5 Accessories

Only use original accessories. These are designed especially for your appliance.

Note: Accessories may become deformed if they get hot. Deformation has no effect on function. As the accessory cools down, it will regain its original shape.

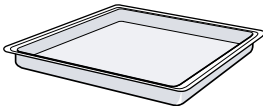
The accessories supplied may differ depending on the appliance model.

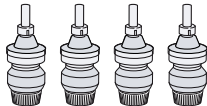
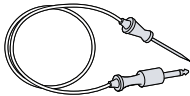
Accessories		Use
Wire rack		<ul style="list-style-type: none"> ■ Cookware ■ Cake tins ■ Ovenproof dishes ■ Roaster
Stainless steel cooking container, unperforated		<ul style="list-style-type: none"> ■ Cooking rice ■ Cooking pulses ■ Cooking cereals ■ Baking tray bakes ■ For catching dripping liquid during steaming
Stainless steel cooking container, perforated		<ul style="list-style-type: none"> ■ Steaming vegetables ■ Steaming fish ■ Extracting juice from berries ■ Defrosting
Set with 4 cleaning cartridges		Cleaning the oven cavity with the cleaning program → <i>Page 32</i>
Core temperature probe		Core temperature probe → <i>Page 23</i> for the highly precise cooking of: <ul style="list-style-type: none"> ■ Meat ■ Fish ■ Poultry ■ Bread

5.1 Other accessories

You can purchase other accessories from our Customer Service, specialist retailers or online.

You will find a comprehensive range of products for your appliance in our brochures and online:

www.gaggenau.com

Accessories are appliance-specific. When purchasing, always check for compatibility with your appliance model number (E-Nr).

You can find out which accessories are available for your appliance in our online shop or from our Customer Service.

Other accessories	Order number
Three-level fully extendable telescopic pull-out rack	BA010301
Stainless steel cooking container, unperforated	BA02036.
Stainless steel cooking container, perforated	BA020370
Cooking container, non-stick, unperforated	BA02038.

Other accessories	Order number
Cooking container, non-stick, perforated	BA020390
Wire rack, with feet	BA030300
Set with 4 cleaning cartridges	CLS10040
Set with 4 descaling tablets	17002490
GN adapter, for use with GN cooking inserts and roasters	GN010330
Stainless steel cooking container, GN 1/3, unperforated 1½" (40 mm) deep, 0.4 gal (1.5 l)	GN114130
Stainless steel cooking container, GN 2/3, unperforated 1½" (40 mm) deep, 0.8 gal (3 l)	GN114230
Stainless steel cooking container, GN 1/3, perforated 1½" (40 mm) deep, 0.4 gal (1.5 l)	GN124130

Other accessories	Order number
Stainless steel cooking container, GN 2/3, perforated 1 1/2" (40 mm) deep, 0.8 gal (3 l)	GN124230
Cast aluminum roaster	GN340230

5.2 Locking function

The locking function prevents the accessories from tilting when they are pulled out.

You can pull out the accessories approximately halfway without them tipping. The accessories must be inserted into the oven cavity correctly for the tilt protection to work correctly.

5.3 Sliding accessories into the oven cavity

The wire rack and the perforated cooking container are equipped with a locking function. For the tilt protection to work correctly, always insert the wire rack and the perforated cooking container into the oven cavity the right way round.

NOTICE:

The accessories may tip.

- ▶ Do not push the accessories between the shelf positions.

1. When inserting the wire rack, ensure that the lug  is facing upwards.

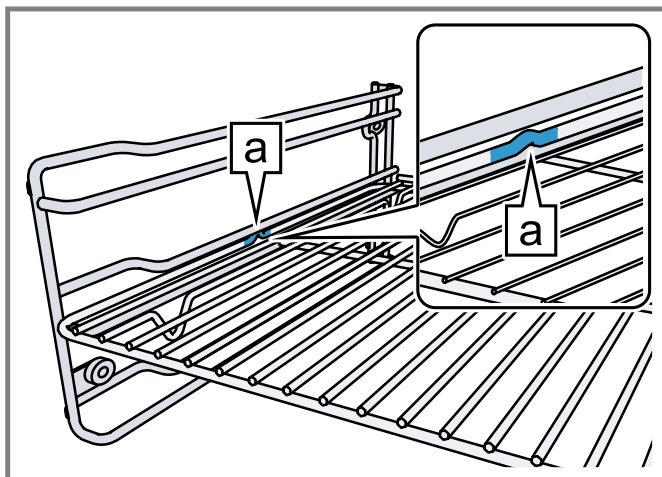

2. Ensure that the safety bracket on the wire rack is located at the rear and is facing upwards.

3. When inserting the cooking container, ensure that the lug  is facing upwards.

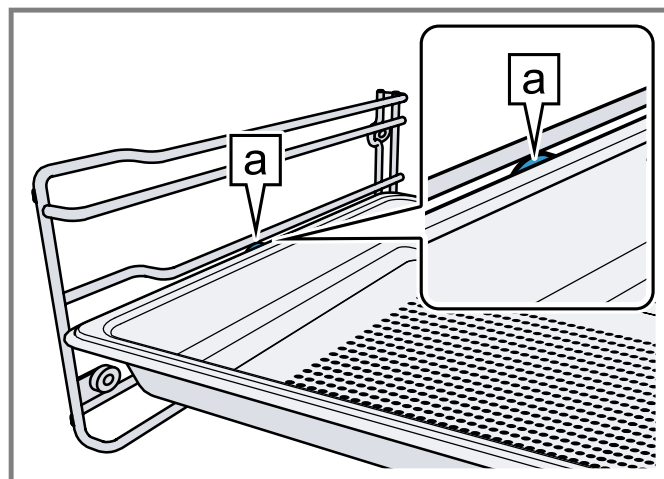

Note: To completely pull out the accessories, lift them slightly.

Remove any accessories that you do not require from the oven cavity.

6 Before using for the first time

Clean the appliance and the accessories.

6.1 Initial use

Implement the settings for initial use before using your appliance.

First read the information under Safety.

The appliance must be installed and connected.

After connecting the appliance to the power supply, the GAGGENAU logo appears for approximately 30 seconds and then the appliance displays the "Initial settings" menu. You can configure your new appliance for initial use.

The "Initial settings" menu appears only after the appliance has been connected to a power supply and switched on for the first time, or if the appliance has not been connected to a power supply for a number of days. You can change all of the settings in the basic settings → Page 28.

Setting the language

Requirement: The display shows the preset language.

1. Use the rotary selector to select the required display language.
2. Press  to confirm.

Setting the time format

Requirement: The display shows the possible formats 24h and AM/PM. 24h is preset.

1. Use the rotary selector to set the required format.
2. Press  to confirm.

Setting the time

Requirement: The display shows the time.

1. Use the rotary selector to set the required time.
2. Press ✓ to confirm.

Set the date format

Requirement: The display shows the possible formats D.M.Y, D/M/Y and M/D/Y. D.M.Y is preset.

1. Use the rotary selector to set the required format.
2. Press ✓ to confirm.

Setting the date

Requirement: The display shows the preset date. The day setting is already active.

1. Use the rotary selector to set the required day.
2. Press > to switch to the month setting.
3. Use the rotary selector to set the month.
4. Press > to switch to the year setting.
5. Turn the rotary selector to set the year.
6. Press ✓ to confirm.

Setting the temperature unit

Requirement: The display shows the possible units °C and °F. The unit °C is preset.

1. Turn the rotary selector to set the required unit.
2. Press ✓ to confirm.

Ending initial use

Requirement: The display shows "Initial use complete".

- ▶ Press ✓.
- ✓ The appliance switches to standby mode.
- ✓ The display shows the standby screen.
- ✓ The appliance is ready to use.

Cleaning the door pane

Note: To ensure tightness, the door seal is lubricated at the factory. Residue may remain on the door pane.

- ▶ Before using for the first time, clean the door pane with glass cleaner and a window cloth or a microfiber cloth. Do not use a glass scraper.

Cleaning the accessories

- ▶ Before first use, clean the accessories thoroughly using hot soapy water and a soft cloth.

Heating up the appliance

1. Ensure that there is no leftover packaging in the oven cavity.
2. Remove any accessories from the oven cavity.
3. To eliminate the new-appliance smell, heat up the empty appliance with the door closed.
The ideal setting for heating is  and 390 °C (200 °C) for one hour.

7 Basic Operation



7.1 Activating the appliance

1. To exit standby mode, open the door and turn the function selector or touch a control panel.
2. Set the required function.



Note: The appliance rinses automatically before each cooking process if it has not been operated for more than 100 hours.

The appliance rinses automatically after every cooking process.

7.2 Opening the appliance door

1. Press .
 - ✓ The appliance opens the appliance door.
2. Use the recessed grip on the side of the oven to open the appliance door fully.
If the childproof lock is activated, press and hold  for a few seconds until the appliance opens the door.

7.3 Switching on the appliance

1. Use the function selector to set the required type of heating.
 - ✓ The display shows the selected type of heating and the suggested temperature.
2. If required, use the rotary selector to set the desired temperature.
 - ✓ The display shows the heating symbol .
 - ✓ The bar shows the current pre-heat status.
 - ✓ Once the appliance reaches the set temperature, a signal tone sounds and the heating symbol goes out .



Note: If you select a different type of heating, the temperature that has been set is retained. The display only shows the suggested temperature once the appliance has been switched on.

7.4 Switching off the appliance

- ▶ Turn the function selector to 0.
Depending on the type of heating, you may hear an automatic rinse cycle running.

7.5 Steam injection

During steam injection, the appliance injects steam into the oven cavity. This enables you to bake food such as bread and bread rolls with sufficient moisture. It also gives yeast-risen baked goods a smooth, shiny crust. Steam injection only works with the following types of heating:

- Hot air + 30% humidity 
- Hot air + 0% humidity 
- Full surface grill + air recirculation 

Starting steam injection

- ▶ Press .
- ✓ After a short time, the appliance injects steam into the oven cavity.
- ✓ Steam is injected for approximately 5 minutes.

Canceling steam injection

- ▶ Press .

7.6 Steam removal

During the steam removal process, the appliance introduces cold water into the oven cavity. The steam condenses on the oven cavity wall and the oven cavity cools down.







If you open the appliance door after steam removal, only a little steam escapes.

WARNING

Hot water may drip down from the appliance door.

- ▶ Wait until the water on the appliance door has cooled down.

Steam removal only works with the following types of heating and if the temperature in the oven cavity is below 270 °C (130 °C):

- Hot air + 100% humidity 
- Hot air + 80% humidity 
- Hot air + 60% humidity 
- Full surface grill setting 1 + humidity 
- Full surface grill setting 2 + humidity 
- Sous-vide cooking 

The steam removal function is also available for a short time after switching off the appliance.

The appliance carries out steam removal automatically at the end of an automatic program → *Page 21* or a timed program (cooking time → *Page 19*).

Starting steam removal

- ▶ Press .
- Steam removal takes approximately 25 seconds.
During steam removal, the heater is switched off.

Stopping steam removal early

- ▶ Open the appliance door or press .

7.7 After each use

After using the steam type of heating, dry the oven cavity to ensure that no moisture remains in the appliance and to prevent odor from building up.

WARNING

Hot steam may escape when you open the appliance door. Steam may not be visible, depending on the temperature.

- ▶ Open the appliance door carefully.
- ▶ Keep children away from the appliance.

Drying the oven cavity

Note: In order to dry the oven cavity, the cooling fan and the fan wheel on the back wall of the oven cavity continue to run for a while after the appliance is switched off. They then switch off automatically. The process of drying the oven cavity may take up to 95 minutes.

1. Keep the appliance door closed while the oven cavity is being dried.
2. Remove food residues and/or dirt from the oven cavity as soon as the appliance has cooled down.
Burnt-on food residue and/or dirt will be much harder to remove later.
3. If required, you can use the drying program to dry the oven cavity quickly. Drying program → *Page 34*
4. Once the oven cavity has cooled down, polish it with a soft cloth.
5. If necessary, wipe dry any condensation on units or handles.

7.8 Switching on the appliance after automatic switch-off

Requirement: After prolonged operation, the → "Automatic switch-off", *Page 14* switches off the appliance.





1. Turn the function selector to 0.
2. Switch the appliance back on again.

8 Timer functions

Your appliance has different timer functions, with which you can control its operation.

8.1 Overview of the timer functions

Use  to select the different timer functions.

Timer function	Use
	Short-term timer
	Cooking time ¹
	Cooking time end ¹
	Stopwatch

¹ Not available in standby mode.

8.2 Calling up the timer menu

Note: You can call up the timer menu from any operating mode. The timer menu is not available if you turn the function selector to S in the basic settings.

- ▶ Press .
- ✓ The display shows the timer menu.

8.3 Exiting the timer menu

- ▶ Press **X**.
- ✓ The timer menu is closed.

- ✓ Any settings that are not saved are lost.

Note: You can exit the timer menu at any time.

8.4 Short-term timer

The short-term timer runs independently of the other appliance settings. You can enter a maximum of 90 minutes.

Setting the short-term timer

1. Press **⏸**.
- ✓ The display shows the "Short-term timer" **⌘** function.
2. Use the rotary selector to set the required time.
3. Press **▶** to start.
 - ✓ The appliance closes the timer menu.
 - ✓ The time counts down.
 - ✓ The display shows **⌘** and the time that has elapsed.
 - ✓ A signal sounds once the time has elapsed.
4. Press **✓**.
 - ✓ The signal tone stops.

Stopping the short-term timer

1. Press **⏸**.
- ✓ The display shows the "Short-term timer" **⌘** function.
2. Press **||**.
 - ✓ The short-term timer stops.
 - ✓ The display shows **▶**.
3. To allow the timer to continue counting down, touch **▶**.

Switching off the short-term timer early

1. Press **⏸**.
- ✓ The display shows the "Short-term timer" **⌘** function.
2. Press **C**.

8.5 Stopwatch

The stopwatch runs independently of the other appliance settings. The stopwatch counts from 0 seconds up to 90 minutes.

The stopwatch has a pause function. This allows you to stop the stopwatch from time to time.

Starting the stopwatch

1. Press **⏸**.
2. Use **➤** to select the "Stopwatch" **⌚** function.
3. Press **▶** to start.
 - ✓ The appliance closes the timer menu.
 - ✓ The time counts down.
 - ✓ The display shows **⌚** and the time that has elapsed.

Stopping the stopwatch

1. Press **⏸**.
2. Use **➤** to select the "Stopwatch" **⌚** function.
3. Press **||**.
 - ✓ The time stops.
 - ✓ The display shows **▶**.

4. To continue to run the stopwatch, press **▶**.
 - ✓ The time continues to run.
 - ✓ Once it has reached 90 minutes, the display flashes and a signal tone sounds.
5. Press **✓**.
 - ✓ The signal tone stops.

Switching off the stopwatch

1. Press **⏸**.
2. Use **➤** to select the "Stopwatch" **⌚** function.
3. Press **C**.

8.6 Cooking time

When you set the cooking time for your food, the appliance automatically switches off after this time. You can set a cooking time of between 1 minute and 23:59 hours.

You can change the type of heating and temperature while the cooking time counts down.

Setting the cooking time

Requirements

- The food is in the oven cavity.
 - You have set the type of heating and the temperature.
1. Press **⏸**.
 2. Use **➤** to select the "Cooking time" **⌚** function.
 3. Set the required cooking time using the rotary selector.
 4. Press **▶** to start.
 - ✓ The appliance starts the cooking time.
 - ✓ The appliance closes the timer menu.
 - ✓ The display shows the temperature, the operating mode, the remaining cooking time, and the cooking time end.
 - ✓ One minute before the end of the cooking time, the display zooms in on the cooking time.
 - ✓ Once the cooking time has elapsed, the appliance switches off.
 - ✓ **⌚** flashes and a signal tone sounds.
 5. Press **✓**, open the appliance door or set the function selector to **0**.
 - ✓ The signal tone stops.

Changing the cooking time

1. Press **⏸**.
2. Use **➤** to select the "Cooking time" **⌚** function.
3. Use the rotary selector to change the cooking time.
4. Press **▶** to start.

Deleting the cooking time

1. Press **⏸**.
2. Use **➤** to select the "Cooking time" **⌚** function.
3. Use **C** to cancel the cooking time.
4. Use **X** to return to normal operation.

Canceling the entire procedure

- ▶ Turn the function selector to 0.







8.7 Cooking time end

You can move the cooking time end to a later time. For example: It is 2:00 PM. The dish requires a cooking time of 40 minutes. You want the meal to be ready at 3:30 PM.





Enter the cooking time of 40 minutes and delay the cooking time end until 3:30 PM. The electronics system calculates the start time. The appliance starts automatically at 2:50 PM and switches off at 3:30 PM. Bear in mind that food which spoils easily should not be left in the appliance for too long.

Delaying the cooking time end

Requirements

- The food is in the oven cavity.
 - You have set the type of heating, temperature, and cooking time.
1. Press .
 2. Use  to select the "Cooking time end"  function.
 3. Use the rotary selector to set the required cooking time end.
 - If  flashes, set the cooking time first.
 4. Press  to start.
 - ✓ The appliance switches to standby.
 - ✓ The display shows the operating mode, temperature, cooking time, and cooking time end.
 - ✓ The appliance starts at the calculated time and automatically switches off once the cooking time has elapsed.
 - ✓ After the cooking time has elapsed,  flashes and a signal tone sounds.
 5. Press , open the appliance door or set the function selector to 0.
 - ✓ The signal tone stops.

Changing the cooking time end

1. Press .
2. Use  to select the "Cooking time end"  function.
3. Set the required cooking time end using the rotary selector.
4. Press  to start.

Canceling the entire procedure

- ▶ Turn the function selector to 0.









9 Long-term timer

With this function, the appliance uses Hot air + 0% humidity  type of heating to keep the temperature between 120 °F (50 °C) and 445 °F (230 °C). You can keep food warm for up to 74 hours without having to switch the appliance on or off.

Bear in mind that food which spoils easily should not be left in the appliance for too long.

9.1 Starting the long-term timer

Requirement: Sabbath mode is set to "Available" in the basic settings → *Page 28*.

1. Turn the function selector to .
2. Press .
 - ✓ The display shows the default value 24h at 185 °F (85 °C).
3. Press  and use the rotary selector to set the required cooking time.
4. Press  and use the rotary selector to set the required end of cooking time.
5. Press , use the rotary selector to set the required switch-off date, and press  to confirm.
6. Turn the rotary selector to set the desired temperature.
7. Press  to start.
 - ✓ The appliance starts Sabbath mode.
 - ✓ The display shows  and the temperature.
 - ✓ The interior lighting and the display light are switched off.
 - ✓ The control panel is locked.
 - ✓ If you touch the control panel, no touch-key tone sounds.
 - ✓ Once the time has elapsed, the appliance no longer heats up and the display goes out.
8. Turn the function selector to 0.

9.2 Switching off the long-term timer



- ▶ Turn the function selector to 0.

10 Child lock

Activate the child lock so that children cannot accidentally switch the appliance on or change the settings. If the child lock is switched on and the power fails, the child lock can be deactivated when the power comes back on.

10.1 Activating the childproof lock

Requirements

- You can set the childproof lock to "Available" in the basic settings → *Page 28*.
 - The function selector is set to 0.
- ▶ Press and hold  for approximately 6 seconds.
 - ✓ The display shows the standby screen and .
 - ✓ The childproof lock is now activated.

10.2 Deactivating the childproof lock

Requirement: The function selector is set to 0.

1. Press and hold  for approximately 6 seconds.
 - ✓ This deactivates the childproof lock.

2. Set the appliance as normal.

11 Automatic programs

You can prepare a wide range of food using the automatic programs. The appliance will choose the optimal setting for you.



11.1 Information about the settings for the automatic programs

Observe the instructions for the settings of the automatic programs.

- The cooking result depends on the quality of the food and the size and type of cookware. For an optimal cooking result, only use food that is in good condition and meat that is chilled to refrigerator temperature. For frozen food, use food straight out of the freezer only.
- The food is divided into categories. One or more dishes are listed for each category. The first position on the display shows the last selected category.
- The automatic program suggests a temperature, type of heating and cooking time.
- For some food, the appliance prompts you to enter the weight. It is not possible to set weights outside of the intended weight range.
- For some dishes, you are asked to enter the desired level of browning, the thickness of the food and the cooking level of the meat or vegetables.
- For some food, preheat the empty cooking compartment. Place the food in the cooking compartment once the preheating is complete and a message appears in the display.
- Your preferred settings are shown next time as a suggestion.
- For some recipes, you will need the core temperature probe. Use the core temperature probe → *Page 23* for these recipes.
- To achieve good results, the cooking compartment must not be too hot for the type of food you have selected. If the cooking compartment is too hot, the display shows a corresponding notification. Allow the appliance to cool and then try again.

11.2 Setting the food



Note: The appliance guides you through the entire setting process. Follow the instructions in the display.

1. Turn the function selector to .
2. Press .
3. Press  to confirm.
4. Use the rotary selector to select the required category.
5. Use the rotary selector to select the food that you require.

For many dishes, you can change the settings to suit your needs.

For some dishes, you must set the weight.

- ✓ The display shows the possible settings.



7. Press .
- ✓ The display shows information about the accessories and preparation.
8. Press  to confirm the required settings.
9. Follow the information on the display.
- ✓ Once the cooking time has elapsed, a signal tone sounds.
- ✓ The appliance stops heating.
- ✓ The appliance carries out steam removal.

Note: If you open the appliance door during an automatic program, this affects the cooking result. Open the appliance door only briefly. The appliance interrupts the automatic program and continues to run when you close the appliance door.

Extending the cooking time

After the cooking time has ended, you can leave some dishes to continue cooking if you are not satisfied with the cooking result.

Requirement: A query appears on the display asking if you want to continue cooking.

1. Press  to confirm.
2. Select a single or double cooking time as required.
3. Press  to start.
4. If the "Continue cooking" function has ended, turn the function selector to 0.

Note: If you press , during the "Continue cooking" time, the appliance carries out the steam removal and ends the extended cooking time.

Changing and canceling the program

Note: Once you have started the program, you can no longer change the settings.





- ▶ Turn the function selector to 0.
- ✓ The appliance ends the program.

11.3 Calling up the last automatic programs used

The appliance saves the last 5 dishes with the settings that you selected. You have the option of saving these dishes with the selected settings as individual recipes.

Note: If you save the settings for the individual recipe using the "Last automatic programs" function, you can no longer retroactively change the settings for individual recipes.

→ *"Individual recipes"*, *Page 22*

1. Turn the function selector to .
- ✓ The display shows .
2. Press .
3. Use the rotary selector to select "Last automatic programs".
4. Press  to confirm.
5. Use the rotary selector to select the food that you require.





6. Enter and save a name for the dish. → *Page 22*

12 Individual recipes



You have the option to save up to 50 individual recipes with a name so that, if required, you can access the recipe quickly and easily. You can record a recipe.

12.1 Recording a recipe





It is possible to set and record up to 5 phases consecutively.







1. Turn the function selector to .
 2. Press .
 3. Use the rotary selector to select "Individual recipes".
 4. Press  to confirm.
 5. Use the rotary selector to select a free memory location.
 6. Press .
 7. Use the function selector to set the required type of heating and the rotary selector to set the required temperature.
- ✓ The appliance records the cooking time.
8. Insert the core temperature probe into the socket in the oven cavity and enter the core temperature for a phase → *Page 22*.
 9. To record another phase, set the function selector to the required type of heating and use the rotary selector to set the required temperature.
- ✓ A new phase starts.
10. When the dish has reached the required cooking result, press .
 11. Enter the name under "ABC".
→ *"Entering a name", Page 22*
The appliance only starts recording a phase once it has reached the set temperature.
Each phase must last at least one minute.
During the first minute of a phase, you can change the type of heating or the temperature.

Entering the core temperature for a phase

1. Insert the core temperature probe → *Page 23* into the socket in the oven cavity.
2. Set the type of heating and the temperature.
3. Press .
4. Use the rotary selector to set the desired core temperature and press  to confirm.



12.2 Programming a recipe

1. Turn the function selector to .
2. Press .
3. Use the rotary selector to select "Individual recipes" and press  to confirm.
4. Use the rotary selector to select a free memory location.
5. Press .















6. Enter the name under "ABC".
→ *"Entering a name", Page 22*
 7. Use  to select the first phase.
- ✓ The display shows the type of heating and temperature that are selected at the start.
8. If required, use the rotary selector to change the type of heating and the temperature.
 9. Insert the core temperature probe into the socket in the oven cavity and enter the core temperature for a phase → *Page 22* or select the time setting using .
- You cannot enter the cooking time for phases with a programmed core temperature.
10. Set the required cooking time using the rotary selector.
 11. If the preparation is complete, use  to finish making entries or use  to select the next phase.
 12. Save with  or cancel and exit the menu with .

Entering the core temperature for a phase





Note: You cannot enter the cooking time for phases with a programmed core temperature.

1. Press  to select the next phase.
2. Set the type of heating and the temperature.
3. Press .
4. Use the rotary selector to set the desired core temperature and press  to confirm.

12.3 Entering a name

1. Enter a name for the recipe under "ABC".
2. Use the rotary selector to select the letters.
A new word always begins with a capital letter.
Latin characters, certain special characters and numbers are available.
3. Briefly press   to position the cursor to the right.
4. Press and hold   to switch to umlauts and special characters.
5. Press   twice to insert a break.
6. Briefly press   to position the cursor to the right.
7. Press and hold   to switch to normal characters.
8. Press   twice to insert a break.
9. Press  to delete a letter.
10. Save with  or cancel and exit the menu with .

12.4 Starting a recipe

1. Turn the function selector to .
2. Press .
3. Use the rotary selector to select "Individual recipes" and press  to confirm.
4. Use the rotary selector to select the desired recipe.
5. If the recipe contains a saved core temperature, insert the core temperature probe → *Page 23*.
6. Press  to start.
The cooking time does not start counting down until the appliance has reached the set temperature.

You can use the rotary selector to change the temperature while the recipe is in progress. Changing the temperature does not change the saved recipe.

- ✓ The operation begins.
- ✓ The cooking time starts counting down.
- ✓ The display shows the settings for the phases on the display bar.

12.5 Changing a recipe

You can change the settings of a recorded or programmed recipe.

1. Turn the function selector to ☼.
2. Press **▼**.
3. Use the rotary selector to select "Individual recipes" and press **✓** to confirm.
4. Use the rotary selector to select the desired recipe.
5. Press **↵**.
6. Use **➤** to select the required phase.
 - ✓ The display shows the programmed type of heating, temperature and cooking time.
7. If required, you can use the rotary selector or function selector to change the settings.
8. Save with **✓** or cancel and exit the menu with **X**.

12.6 Deleting a recipe

1. Turn the function selector to ☼.
2. Press **▼**.
3. Use the rotary selector to select "Individual recipes" and press **✓** to confirm.
4. Use the rotary selector to select the desired recipe.
5. Use **C** to delete the recipe.
6. Press **✓** to confirm.

13 Core temperature sensor

The core temperature probe makes it possible to cook with exact precision. The core temperature probe measures the temperature at 3 measuring points inside the food. When the required core temperature is reached, the appliance automatically switches off, ensuring that all food is cooked perfectly.

⚠ WARNING

The oven cavity and the core temperature probe become very hot.

- ▶ Use oven gloves when inserting and removing the core temperature probe.

NOTICE:

Temperatures above 480°F (250°C) damage the core temperature probe.

- ▶ Only use the core temperature probe in your appliance at a maximum temperature of 445°F (230°C).

⚠ WARNING

An incorrect core temperature probe may damage the insulation.

- ▶ Only use the core temperature probe that is suitable for this appliance.

NOTICE:

Moisture may damage the core temperature probe.

- ▶ Do not clean the core temperature probe in the dishwasher.

⚠ WARNING

The core temperature probe is sharp.

- ▶ Handle the core temperature probe with care.

Only use the core temperature probe supplied. The core temperature probe is available as a spare part from customer service or the online shop.

If you use the core temperature probe, never place the food on the top shelf level.

After use, always remove the core temperature probe from the cooking compartment. Never store the core temperature probe in the cooking compartment.

After each use, clean the core temperature probe with a damp cloth.

13.1 Estimated cooking time

After preheating, if the appliance has a temperature setting above 210 °F (100 °C) and the core temperature probe is inserted, the display shows an estimated cooking time approximately 5 to 20 minutes into the cooking time. The appliance continuously updates the estimated cooking time.

The longer the cooking process lasts, the more precise the estimated cooking time becomes. Do not open the appliance door; this distorts the estimated cooking time. The display shows the estimated cooking time in normal operation and in the automatic program.

Press **i** to display the current core temperature.

To display the current core temperature instead of the estimated cooking time, change the settings in the basic settings → *Page 28*.

The display shows "<60°F (<15°C)" for the current core temperature at the beginning of the cooking time for approximately 3 to 4 minutes.

The measurable range is 60-210 °F (15-99 °C). Outside of the measurable range, the display shows "<60°F (15°C)" or "--°F (--°C)" for the current core temperature.

If you leave food in the cooking compartment for some time after cooking, the core temperature will continue to rise somewhat due to the residual heat in the cooking compartment.

If you set programs with the core temperature probe and the cooking timer at the same time, the appliance switches off whichever program reaches the entered value first.

13.2 Core temperature guideline values

The following overview provides you with guideline values for the core temperature. The guideline values depend on the quality and composition of the food.

Only use fresh food that has not been frozen. For hygiene reasons, ensure that critical foods such as fish and game reach a core temperature of at least 140-160 °F (62-70 °C) and poultry and minced meat 180-185 °F (80-85 °C).

Food	Core temperature guideline value in °F (°C)
Beef	
Sirloin, fillet of beef, entrecôte, very rare	113-116 (45-47)
Sirloin, fillet of beef, entrecôte, rare	122-125 (50-52)
Sirloin, fillet of beef, entrecôte, medium rare	136-140 (58-60)
Sirloin, fillet of beef, entrecôte, well done	158-167 (70-75)
Roast beef	176-185 (80-85)
Pork	
Joint of pork	162-176 (72-80)
Loin of pork, medium rare	149-158 (65-70)
Pork loin, well done	167 (75)
Meatloaf	185 (85)
Fillet of pork	149-158 (65-70)
Veal	
Joint of veal, well done	167-176 (75-80)
Breast of veal, stuffed	167-176 (75-80)
Saddle of veal, medium rare	136-140
Saddle of veal, well done	149-158 (65-70)
Fillet of veal, rare	122-125 (50-52)
Fillet of veal, medium rare	136-140
Fillet of veal, well done	158-167 (70-75)
Game	
Saddle of venison	140-158 (60-70)
Leg of venison	158-167 (70-75)
Venison loin steaks	149-158 (65-70)
Saddle of hare, saddle of rabbit	149-158 (65-70)
Poultry	
Chicken	194 (90)
Guinea fowl	176-185 (80-85)
Goose, turkey, duck	185-194 (85-90)
Duck breast, medium rare	131-140 (55-60)
Duck breast, well done	158-176 (70-80)
Ostrich steak	140-149 (60-65)
Lamb	

Food	Core temperature guideline value in °F (°C)
Leg of lamb, medium rare	140-149 (60-65)
Leg of lamb, well done	158-176 (70-80)
Saddle of lamb, medium rare	131-140 (55-60)
Saddle of lamb, well done	149-167 (65-75)
Mutton	
Leg of mutton, medium rare	158-167 (70-75)
Leg of mutton, well done	176-185 (80-85)
Saddle of mutton, medium rare	158-167 (70-75)
Saddle of mutton, well done	176 (80)
Fish	
Fillet	144-149 (62-65)
Whole	149 (65)
Terrine	144-149 (62-65)
Other	
Bread	205 (96)
Pâté	162-167 (72-75)
Terrine	140-158 (60-70)
Foie gras	113 (45)
Reheating food	167 (75)

13.3 Inserting the core temperature probe into the food

1. Insert the core temperature probe fully into the food.
2. Do not insert the core temperature probe into the fat.
3. Ensure that the core temperature probe is not touching any cookware or any bones.
4. Place the food in the oven cavity.

Inserting the core temperature probe into meat

1. Insert the core temperature probe at the thickest point on the side as far as it will go into the meat.

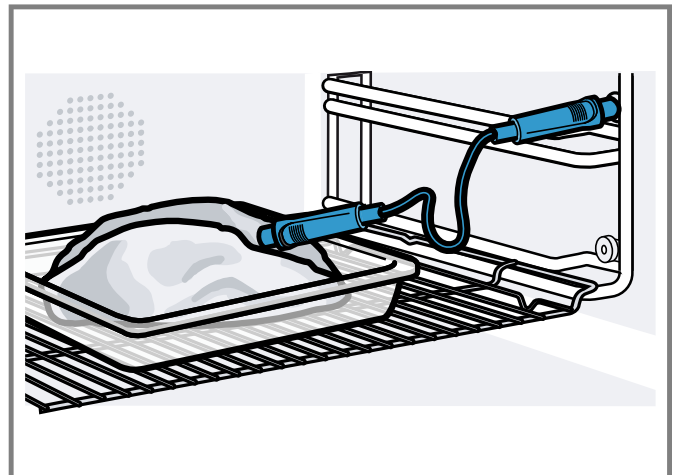

2. If there is more than one piece of meat, insert the core temperature probe into the middle of the thickest piece.

Inserting the core temperature probe into poultry

1. Insert the core temperature probe as far as it will go into the thickest point in the breast.

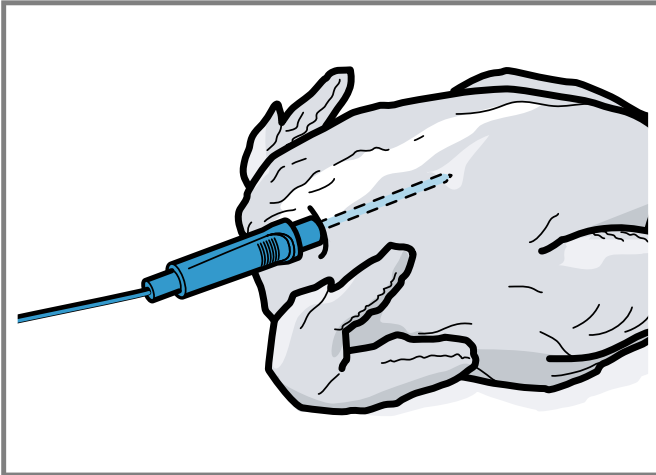

2. Depending on its composition, insert the core temperature probe into the poultry crossways or lengthways.

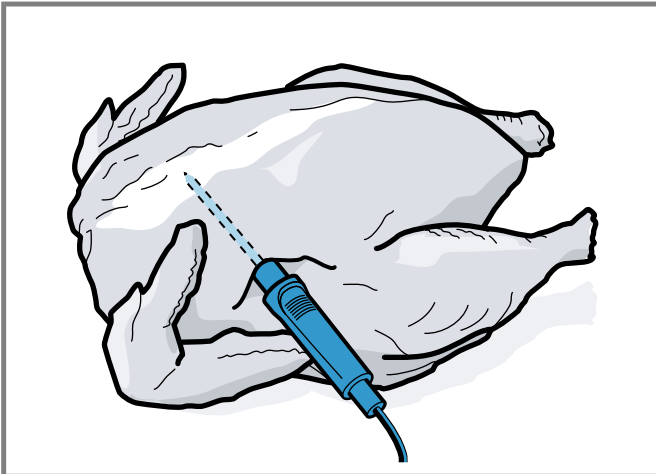

3. With poultry, ensure that the tip of the core temperature probe does not protrude into the cavity in the middle of the bird.

Inserting the core temperature probe into fish

1. Insert the core temperature probe behind the head as far as it will go towards the spine.

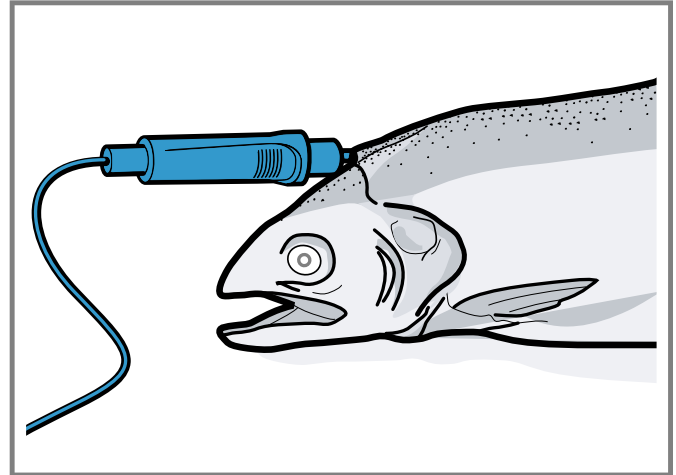

2. Place the whole fish onto the wire rack and prop it up in the swimming position using half a potato.

13.4 Turning the food

1. Do not pull out the core temperature probe when turning the food.

If you pull out the core temperature probe during operation, the appliance resets all settings. You must then reset the settings.

2. Turn the food.
3. Once you have turned the food, check that the core temperature probe is correctly positioned in the food.

13.5 Setting the core temperature probe

NOTICE:



The heat of the grill heating element may damage the core temperature probe.

- ▶ Ensure that the distance between the grill heating element and the core temperature probe and the cable of the core temperature probe is a few centimeters. In doing so, ensure that the meat can expand during the cooking process.



You may damage the cable of the core temperature probe with the appliance door.

- ▶ Do not trap the cable of the core temperature probe in the appliance door.

1. Slide the food into the oven cavity with the core temperature probe inserted.
2. Insert the core temperature probe into the socket in the oven cavity.
3. Close the appliance door.
4. Turn the function selector to the required type of heating.
5. Use the rotary selector to set the oven cavity temperature.
6. Press .

7. Use the rotary selector to set the desired core temperature and press  to confirm.
 - Ensure that the set core temperature is higher than the current core temperature.
 You can change the set core temperature at any time.
 - ✓ The appliance heats up using the set type of heating.
 - ✓ The display shows the current core temperature and, beneath it, the set core temperature.
 - ✓ Once the set core temperature is reached, a signal sounds.
 - ✓ The appliance ends the cooking process automatically.
8. Press  to confirm.
9. Turn the function selector to 0.

Changing the set core temperature

1. Press .
2. Use the rotary selector to change the set core temperature for the food and press  to confirm.

Deleting the set core temperature

1. Press .
2. Use **C** to delete the set core temperature.
 - ✓ The appliance continues heating in normal cooking mode.

14 Home Connect®

This appliance is network-capable. Connecting your appliance to a mobile device lets you control its functions via the Home Connect® app, adjust its basic settings and monitor its operating status.

The Home Connect® services are not available in every country. The availability of the Home Connect® function depends on the availability of Home Connect® services in your country. You can find information on this at: www.home-connect.com.

The Home Connect® app guides you through the entire registration process. Follow the instructions in the Home Connect® app to implement the settings.

Tip: Follow the instructions in the Home Connect® app as well.

14.3 Home Connect® settings

You can adjust the settings and network settings for Home Connect® in the basic settings for your appliance. Which settings the display shows will depend on whether Home Connect® has been set up and whether the appliance is connected to your home network.

Symbol	Basic setting	Possible settings	Explanation
	Connection type	LAN Wi-Fi	You can switch between connection types (LAN cable and Wi-Fi). Follow the instructions for setting up the relevant connection type.

Notes

- Also note the safety information in this instruction manual and ensure that it is also observed when operating the appliance using the Home Connect® app.
- Operating the appliance on the appliance itself always takes priority. It is not possible to operate the appliance using the Home Connect® app during this time.
- In networked standby mode, the appliance requires a maximum of 2 watts.
- If you want to operate the appliance via the Home Connect® app, you must activate the remote control function in the Home Connect® settings first. This function is for your own safety. Turn the function selector on the appliance to the light position  to enable the remote control function.

14.1 Setting up the Home Connect® app

1. Install the Home Connect® app on your mobile device.
2. Start the Home Connect® app and set up access for Home Connect®.

The Home Connect® app guides you through the entire registration process.











14.2 Setting up Home Connect®

Requirements

- The appliance is connected to the power supply and is switched on.
 - You have a mobile device with a current version of the iOS or Android operating system, e.g. a smartphone.
 - The Home Connect® app is installed on your mobile device.
 - The appliance receives signals from the WLAN home network (Wi-Fi) at its installation location.
 - The mobile device and the appliance are within range of your home network's Wi-Fi signal.
1. Open the Home Connect® app and scan the following QR code.



2. Follow the instructions in the Home Connect® app.

Symbol	Basic setting	Possible settings	Explanation
	Connection	Connect Disconnect	You can switch the network connection on or off as required. The network information is retained after the appliance is switched off. After switching on the appliance, wait for a few seconds until it reconnects to the network. Note: In networked standby mode, the appliance requires a maximum of 2 W.
	Connect to app		Start the connection process between the app and the appliance.
	Software update		As soon as a new software version is available, a message appears on the display. In the Home Connect® menu, you can install the new software using  .
	Remote control	Activate Deactivate	You can use the Home Connect® app to access the appliance's functions. If the remote control has been deactivated, only the appliance's operating statuses are displayed in the app. The remote control is only available if you set the rotary selector to light position  The light goes out after a few minutes.
	Permanent remote start	Activate Deactivate	When permanent remote start is activated, you can start and operate your appliance at any time without prior approval on the appliance. Permanent remote start is only available if you set the rotary selector to light position  The light goes out after a few minutes.
	Delete network settings		You can delete all network settings from the appliance at any time.
	Appliance information		The display shows: <ul style="list-style-type: none"> ■ MAC address COM module ■ Serial number of the appliance ■ Software version Depending on the connection type, you can view more information, such as the SSID network name, by touching the arrow button.

14.4 Data Protection

See the information on data protection.

The first time your appliance is registered on a home network connected to the Internet, your appliance transmits the following types of data to the Home Connect® server (initial registration):

- Unique appliance identification (consisting of appliance codes as well as the MAC address of the installed Wi-Fi communication module).
- Security certificate of the Wi-Fi communication module (to ensure a secure data connection).
- The current software and hardware version of your home appliance.
- Status of any previous reset to factory settings.

This initial registration prepares the Home Connect® functions for use and is only required when you want to use the Home Connect® functions for the first time.













Note: Please note that the Home Connect® functions can only be used in conjunction with the Home Connect® app. Information on data protection can be retrieved in the Home Connect® app.

15 Basic settings









You can configure the basic settings for your appliance to meet your needs.

15.1 Overview of the basic settings





Here you can find an overview of the basic settings and factory settings. The basic settings depend on the features of your appliance.

Display	Basic setting	Selection	Description
	Brightness	Levels 1, 2, 3, 4, 5 ¹ , 6, 7, 8	Set the display brightness.
	Standby screen	On ¹ Off <ul style="list-style-type: none"> ▪ Clock ▪ Clock + GAGGENAU logo¹ ▪ Date ▪ Date + GAGGENAU logo ▪ Clock + date ▪ Clock + date + GAGGENAU logo 	Appearance of the standby screen Off: No display. You can use this setting to reduce the standby energy consumption of your appliance. On: Multiple screens can be adjusted. Press ✓ to confirm "On" and use the rotary selector to select the required screen.
	Display screen	Reduced ¹ Standard	"Reduced": After a short time, the display shows only the most important information.
	Touch field color	Gray ¹ White	Select the color of the symbols on the touch fields.
	Touch field tone type	Tone 1 ¹ Tone 2 Off	Press a touch field to select a signal tone.
	Touch field tone volume	Levels 1, 2, 3, 4, 5 ¹ , 6, 7, 8	Set the volume of the touch field tone.
	Heating up signal	On ¹ Off	The signal tone sounds when the appliance reaches the required temperature when heating up.
	Signal volume	Levels 1, 2, 3, 4, 5 ¹ , 6, 7, 8	Set the volume of the signal tone.
	Time format	AM/PM 24h ¹	Set the 24-hour format set or 12-hour format.
	Time	Current time	Set the time.
	Clock change	Manual ¹ Automatic	Automatic conversion of the time when changing from summer time to winter time.
	Date format	D.M.Y ¹ D/M/Y M/D/Y	Set the date format.
	Date	Current date	Set the date. Press > to switch between the year, month and day.

¹ Factory setting (may vary according to model)

Display	Basic setting	Selection	Description
	Temperature unit	°C ¹ °F	Set the temperature unit.
	Weight unit	kg ¹ oz.	Set the weight unit.
	Language	German ¹ French [...] English	Set the language for the text display. The system restarts when you change the language. The restart takes a few seconds. After restarting, the appliance closes the basic settings menu.
	Factory settings	Restore the appliance to the factory settings	The question "Delete all individual settings and restore appliance to factory settings?" must be confirmed with ✓ or canceled with ✗. When restoring factory settings, the appliance will delete individual recipes. After restoring the factory settings, you will see the "Initial settings" menu.
	Demo mode	On ¹ Off	The demo mode is used for demonstration purposes only. The appliance does not heat up in demo mode. All other functions are available. The setting "Off" must be activated for normal operation. The setting is only possible in the first 3 minutes after connecting the appliance.
	Demo cleaning program	Start demo cleaning program	The demo cleaning program is provided for demonstration purposes only. The program has no cleaning function or heating function. The demo cleaning program takes 10 minutes. You can end the program at any time. You need a new or previously used standard cleaning cartridge. Manually dry the oven cavity after the end of the program.
	Long-term timer	Not available ¹ Available	Available: You can set the long-term timer → <i>Page 20</i> .
	Display estimated cooking time with core temperature probe	On ¹ Off	On: If you are using the core temperature probe, the display shows the estimated cooking time.

¹ Factory setting (may vary according to model)

Display	Basic setting	Selection	Description
	Door lock	Off ¹ On	The door lock prevents the appliance door from opening accidentally. With the "On" setting, press and hold  for several seconds until the door opens.
	Childproof lock	Not available ¹ Available	Available: You can activate the childproof lock → <i>Page 20.</i>
	Home network	LAN / WLAN Connection type Connection Connect to app Software update Remote control Permanent remote start Delete network settings Appliance info	Select settings for the connection to the home network and mobile devices. The display shows different setting options depending on the connection status.

¹ Factory setting (may vary according to model)

15.2 Changing the basic settings

1. Turn the function selector to S.
 2. Use the rotary selector to select "Basic settings".
 3. Press ✓.
 4. Use the rotary selector to select the required basic setting.
 5. Press _.
 6. Use the rotary selector to set the basic setting.
 7. Press ✓ to save, or press X to cancel and exit the current basic setting.
 8. Turn the function selector to 0 to exit the basic settings menu.
- ✓ The changes are saved.

WARNING

The appliance and its parts that can be touched become hot during use.

- ▶ Caution should be exercised here in order to avoid touching heating elements.
- ▶ Young children under 8 years of age must be kept away from the appliance.

WARNING

Scratched glass in the appliance door may develop into a crack.

- ▶ Do not use any harsh or abrasive cleaners or sharp metal scrapers to clean the glass on the appliance door, as they may scratch the surface.

NOTICE:

Unsuitable cleaning agents damage the surfaces of the appliance.

- ▶ Do not use harsh or abrasive cleaning agents.
- ▶ Do not use cleaning agents with a high alcohol content.
- ▶ Do not use hard scouring pads or cleaning sponges.
- ▶ Do not use any special cleaners for cleaning the appliance while it is hot.

Salt contained in new sponge cloths may damage surfaces.

- ▶ Wash new sponge cloths thoroughly before use.
- Using oven cleaner in a hot oven cavity damages the stainless steel surfaces.
- ▶ Never use oven cleaner in the oven cavity when it is still warm.
 - ▶ Remove all food remnants from the oven cavity and the appliance door before you next heat up the appliance.

16 Cleaning and maintenance

To keep your appliance working efficiently for a long time, it is important to clean and maintain it carefully.

16.1 Cleaning agents

To avoid damaging the various surfaces on the appliance, do not use any unsuitable cleaning agents.

WARNING

Moisture intrusion may cause an electric shock.

- ▶ Do not use any steam cleaners or high-pressure cleaners to clean the appliance.

Suitable cleaning agents

Only use cleaning agents that are suitable for the different surfaces on your appliance.

Appliance door

Area	Suitable cleaning agents	Notes
Door pane	<ul style="list-style-type: none"> ▪ Glass cleaner 	Do not use a glass scraper. Clean with a window cloth or a microfiber cloth.
Door seal	<ul style="list-style-type: none"> ▪ Hot soapy water 	Clean with a dish cloth. Do not remove or scrub. Do not use metal scrapers or glass scrapers for cleaning.
Display	<ul style="list-style-type: none"> ▪ Soapy water 	Wipe down using a microfiber cloth or a slightly damp cloth. Do not wipe with a wet cloth.

Cooking compartment

Area	Suitable cleaning agents	Notes
Oven cavity inner walls	<ul style="list-style-type: none"> ▪ Hot soapy water 	Clean with a dishcloth and then dry with a soft cloth. Stainless steel cleaner that is suitable for the appliance can be obtained from customer service or online. To prevent corrosion, remove any patches of limescale, grease, starch or albumin (e.g. egg white) from stainless steel surfaces immediately. Corrosion may form under such stains. Do not use oven spray or other aggressive oven cleaners or abrasive materials. Scouring pads, rough sponges and pan cleaners are unsuitable. These items scratch the surface. Always dry the oven cavity after cleaning. → <i>"Drying program", Page 34</i> Note: Undissolved detergent causes patches to appear when heating up and these patches cannot be removed. Thoroughly remove residues from detergents or care products using clean water before drying the oven cavity.
Lightly soiled cooking compartment	<ul style="list-style-type: none"> ▪ Cleaning aid 	The cleaning aid loosens stubborn dirt in the cooking compartment and makes cleaning easier.
Very dirty oven cavity	<ul style="list-style-type: none"> ▪ Cleaning program 	The cleaning program → <i>Page 32</i> removes stubborn dirt.
Glass ceramic grilling surface	<ul style="list-style-type: none"> ▪ Glass ceramic cleaner 	Regularly clean with glass ceramic cleaner. Do not use a glass scraper.
Glass cover for the oven cavity light	<ul style="list-style-type: none"> ▪ Hot soapy water 	Clean with a dish cloth.
Water tank	<ul style="list-style-type: none"> ▪ Hot soapy water ▪ Dishwasher 	To remove residual detergent after cleaning, rinse thoroughly with clean water. Clean in the dishwasher as necessary. Remove the lid and place the water tank upside down in the dishwasher. Note: Before fitting the lid, ensure that the suction hose is free of residues. → <i>"Check the water tank", Page 39</i> After cleaning, leave the water tank to dry with the lid open.
Shelf supports	<ul style="list-style-type: none"> ▪ Dishwasher ▪ Hot soapy water 	Note: If required, remove the shelf supports for cleaning. → <i>"Removing the shelf supports", Page 36</i> In the event of heavy soiling, leave to soak and use a brush.
Cooking container, wire rack	<ul style="list-style-type: none"> ▪ Dishwasher ▪ Hot soapy water 	Soak burned-on residues and clean with a brush. Light-colored patches on stainless steel are caused by protein residues. Remove these stains with lemon juice. Rinse thoroughly with clean water.
Core temperature probe	<ul style="list-style-type: none"> ▪ Hot soapy water 	Wipe with a damp cloth Do not clean in the dishwasher.

16.2 Microfiber cloth

The honeycomb microfiber cloth is especially suitable for cleaning easily damaged surfaces, such as glass, glass ceramic, stainless steel or aluminum. The microfiber cloth removes liquid and greasy deposits in one go.

The microfiber cloth can be obtained from customer service or from the online shop.

16.3 Cleaning the drain filter

1. If necessary, clean the drain filter.

When cooking fish or meat, we recommend cleaning the appliance after each use.

2. Turn the drain filter counterclockwise ① and remove it ②.

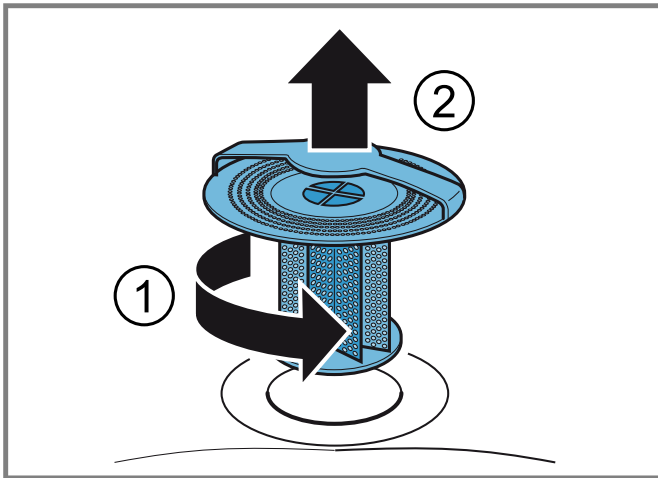

3. Remove any food remnants from the drain filter.

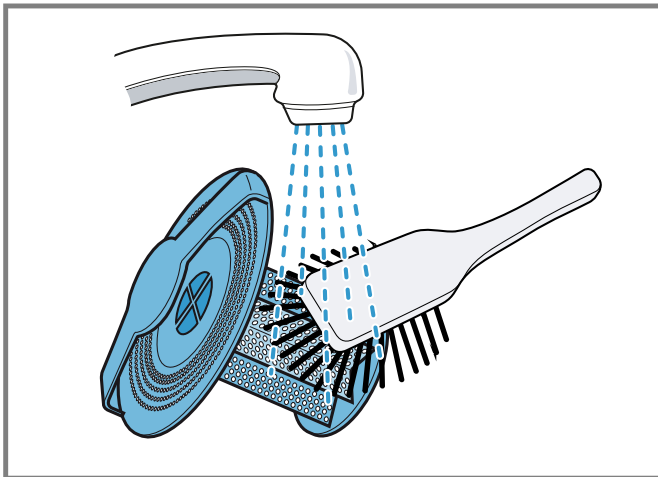

4. If it is very dirty, rinse out the drain filter under running water or clean it in the dishwasher.
5. Insert the drain filter and turn it clockwise as far as it will go.

Note: Never operate the combi-steam oven without the drain filter in place.



16.4 Cleaning program

The cleaning program removes stubborn dirt using a cleaning cartridge, and cleans, rinses and dries the oven cavity fully automatically. You need special cleaning cartridges for the cleaning program.

NOTICE:

Heat may melt the cleaning cartridge and damage the oven cavity.

- ▶ Use cleaning cartridges for the cleaning program only.
- ▶ Never place cleaning cartridges in the oven cavity when it is hot or heat them up in the oven cavity.

Screw a cleaning cartridge  in at the top of the appliance. Ensure that the drain filter remains inserted in the oven cavity floor while the cleaning program is in progress. If you remove the drain filter  before the cleaning program is started, the oven cavity will not be clean.

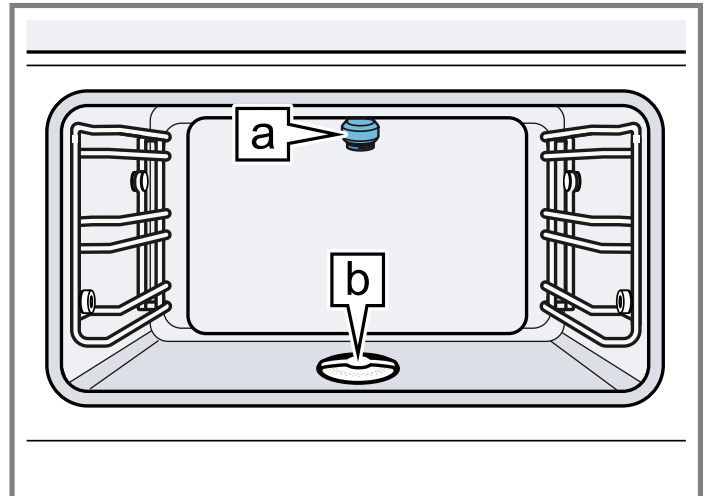

The cleaning cartridges can be obtained from customer service or from the online shop. You can only use the cleaning cartridges once and cannot refill them. Do not use any other cleaner.

Depending on which version of the appliance you have, the complete cleaning program takes either 3 hours 20 minutes or 3 hours 45 minutes.

With normal use, we recommend cleaning the appliance with the cleaning program four times a year. Depending on the use, more frequent cleaning can be necessary.

If there are a lot of food remnants, do not allow them to burn on. Start the cleaning program as soon as the appliance has cooled to 105 °F (40 °C).



You can only restart the cleaning program once the appliance has cooled down to below 40 °C.

Remove all accessories from the oven cavity before you start the cleaning program. Remove the wire rack, the cooking container and the core temperature probe. The appliance door is locked during the cleaning program. Do not try and open the appliance door during the cleaning program. The water may escape from the oven cavity.

The noise from the appliance fan is louder when the cleaning program is in progress. This is normal.

Always allow the cleaning program to run to the end. You cannot cancel the cleaning program.

Selecting the switch-off time

1. Set the function selector to S.
 - ✓ The display shows .
2. Press  to confirm.
 - ✓ The display shows the switch-off time at which the cleaning program will end.
3. If required, you can use the rotary selector to delay the switch-off time.
 - ✓ The appliance moves the start time and switch-off time. The cleaning time remains the same.

Preparing the appliance for the cleaning program

WARNING

The cleaning agent solution may cause chemical burns in the mouth, throat and eyes or on the skin.

- ▶ Follow the safety instructions on the packaging of the cleaning cartridges.
- ▶ Do not drink the cleaning agent solution.
- ▶ The cleaning agent solution must not come into contact with food.
- ▶ Dispose of the empty cleaning cartridge in accordance with regional regulations for household garbage.

NOTICE:

Heat may damage the inserted cartridge.

- ▶ Never heat up the appliance if you have inserted the cartridge.
1. Remove all accessories from the oven cavity.
 2. Remove coarse dirt.
 3. Press  to confirm.
 4. Ensure that the drain filter remains inserted in the oven cavity floor while the cleaning program is in progress.

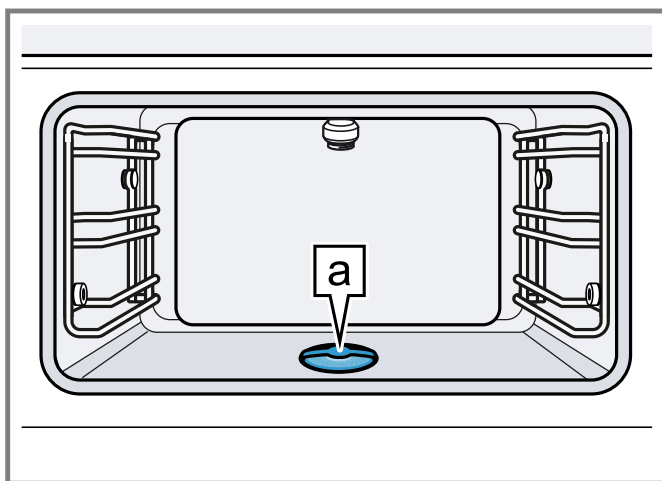

If you remove the drain filter  before the cleaning program is started, the oven cavity will not be clean.

5. Press  to confirm.
6. In order to loosen the cleaning powder, gently tap the cartridge against the countertop.

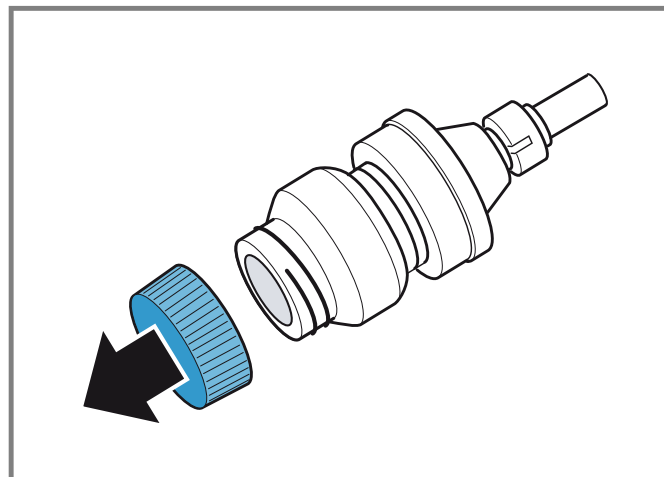

7. Remove the locking cap from the cleaning cartridge.
 - Do not remove the wax plugs from the opening of the cleaning cartridge.
 - Do not use any other cleaning agents.
 - Do not use damaged cartridges.

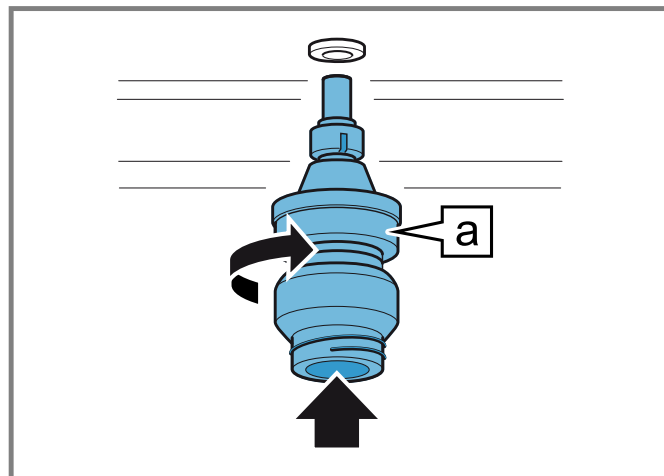

8. Screw the cleaning cartridge  fully into the socket in the top of the oven cavity.



Starting the cleaning program

1. Close the appliance door.
2. Press  to confirm.
 - ✓ The display shows the cleaning time of 3:45.
3. Press  to start.
 - ✓ The cleaning time counts down on the display.
 - ✓ The light in the oven cavity remains switched off.
 - ✓ The appliance door is locked.
 - ✓ Once the cleaning program has finished, a signal sounds.
 - ✓ The appliance unlocks the appliance door.
 - ✓ The display shows a message.

Ending the cleaning program

1. Remove the cleaning cartridge.

- Turn the drain filter in the oven cavity floor counterclockwise ① and remove it ②.

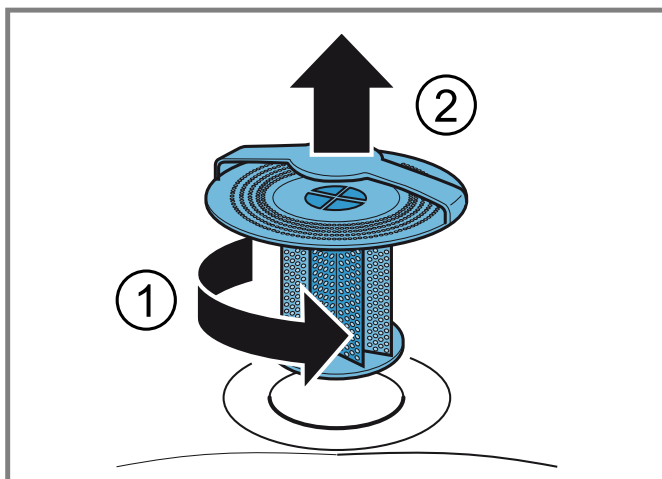

- Remove any food remnants from the drain filter.
- Rinse out the drain filter under running water.

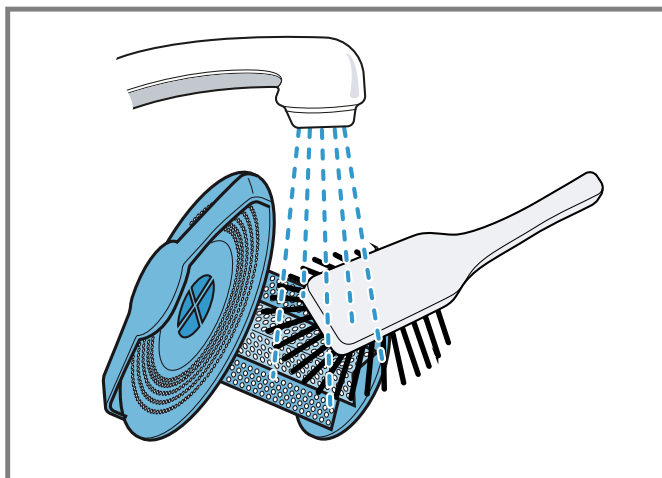

- Press ✓ to confirm.
 - ✓ The cleaning program is complete.
- Allow the appliance to cool down.
- Polish the oven cavity and door pane with a soft cloth.
 - If required, remove the white streaks in the oven cavity and on the door pane with a damp cloth. Depending on the water hardness, the final rinse may leave white streaks in the oven cavity and on the door pane after drying.
- Dispose of the empty cleaning cartridge in accordance with regional regulations for household garbage.

Causes of an unsatisfactory cleaning result

⚠ WARNING

The cleaning agent solution may cause chemical burns in the mouth, throat and eyes or on the skin.

- ▶ To prevent the detergent from coming into contact with your skin or eyes, do not remove the locking cap from a spent cartridge.

Possible cause	Solution
The locking cap is still on the cleaning cartridge.	After the end of the cleaning program, remove the cleaning cartridge from the appliance. Do not reuse the cleaning cartridge. Dispose of the cleaning cartridge in accordance with the regional regulations.
The drain filter is missing.	Ensure that the drain filter remains inserted in the oven cavity floor while the cleaning program is in progress.
The power has failed.	Following a power failure that lasts longer than 3 minutes, the cleaning program is ended with a short program.
Dirt is heavily baked on.	Run the cleaning program again to remove stubborn dirt.

16.5 Drying program

You can use the drying program to dry the cooking compartment quickly after cleaning or steaming. The drying program runs for 20 minutes.

NOTICE:

Heat damages the water tank.

- ▶ Do not dry the water tank in the hot oven cavity.

Starting the drying program

- Set the function selector to S.
- Use the rotary selector to select the drying program.
 - ✓ The display shows .
- Press ✓ to confirm.
 - ✓ The display shows the drying time as 20 minutes.
- Press ▶ to start.
 - ✓ The display shows the drying time that has elapsed.
 - ✓ The light in the oven cavity remains switched off.
 - ✓ A signal sounds after 20 minutes.
 - ✓ The display shows a message.
- Press ✓ to confirm.
 - ✓ The drying program has ended.
- Allow the appliance to cool down.
- Polish the oven cavity and door pane with a soft cloth.

16.6 Descaling program

You can use the descaling program to descale and rinse the appliance fully automatically using special descaling tablets.

NOTICE:

Limescale may damage the appliance.

- ▶ Descal the appliance regularly.

Using the wrong descaler may damage the appliance.

- ▶ Only use the specified descaling tablets.

The descaling tablet may damage the oven cavity.

- ▶ Use the descaling tablet for the descaling program only.
- ▶ Place the descaling tablet into the water tank.
- ▶ Never place the descaling tablet in the oven cavity or heat it up in the oven cavity.

The descaling tablets can be obtained from customer service, our website or the online shop.

If you descale the appliance regularly, your appliance will be in a good condition.

Depending on the water hardness and the use of the appliance, a message on the display reminds you to run the descaling program.

To prevent damage to the appliance, the appliance locks the operating modes that use steam after this message has been repeated. You can still use the appliance to run operating modes that do not require steam. You can only use the appliance without any restrictions after you have run the descaling program.

The descaling program takes 1 hour 45 minutes from beginning to end. After 1 hour 30 minutes, empty, clean and refill the water tank.

Even if you use a water-descaling system, descaling may be necessary, depending on the water type and your use of the appliance.

Preparing the descaling program

⚠ WARNING

The descaling tablets may cause chemical burns in the mouth, throat, eyes and on the skin.

- ▶ Follow the safety instructions on the packaging of the descaling tablets.
- ▶ Avoid the skin coming into contact with the descaling tablets.
- ▶ Keep children away from the descaling tablets.

The descaling solution may cause chemical burns in the mouth, throat and eyes or on the skin.

- ▶ Avoid the skin coming into contact with the descaling solution.
- ▶ Keep children away from the descaling solution.
- ▶ Do not drink the descaling solution.
- ▶ The descaling solution must not come into contact with food.
- ▶ Clean the water tank in the dishwasher or thoroughly by hand before you next use the appliance.

NOTICE:

Using the wrong descaler may damage the appliance.

- ▶ Only use the specified descaling tablets.

1. Set the function selector to S.
2. Use the rotary selector to select the descaling program.
You cannot cancel the descaling program. Always allow the descaling program to run to the end.
 - ✓ The display shows .
3. Press ✓ to confirm.
4. Remove all accessories from the oven cavity.
5. Remove the water tank from the appliance and take off the lid.
6. Remove the descaling tablet from the plastic packaging.
7. Place the descaling tablet in the compartment at the back of the water tank.

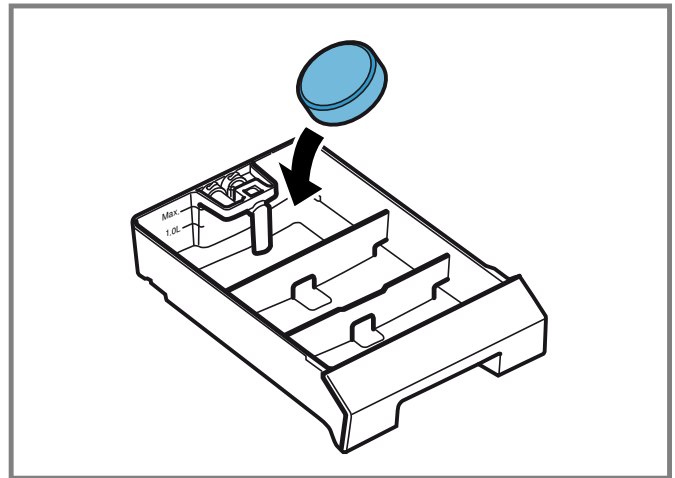

8. Position the lid on the tank and click it into place.
9. Fill the water tank up to the "Max." mark with 1.7 l cold water.

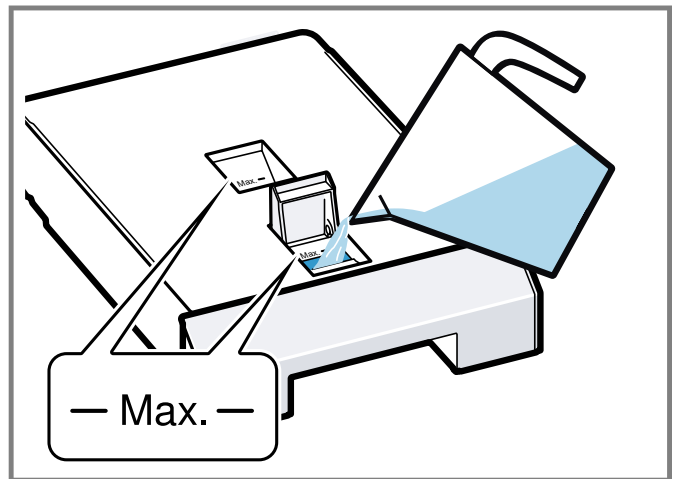

10. Slide the water tank back in as far as it will go.

Starting the descaling program

1. Close the appliance door.
2. Press ✓ to confirm.
 - ✓ The display shows the descaling time.
3. Press ▶ to start.
 - ✓ The descaling time counts down on the display.
 - ✓ The light in the oven cavity remains switched off.
 - ✓ After approximately 1 hour 30 minutes, the display shows a message.

Continuing the descaling program

⚠ WARNING

The descaling solution may cause chemical burns in the mouth, throat and eyes or on the skin.

- ▶ Avoid the skin coming into contact with the descaling solution.
- ▶ Keep children away from the descaling solution.
- ▶ Do not drink the descaling solution.
- ▶ The descaling solution must not come into contact with food.
- ▶ Clean the water tank in the dishwasher or thoroughly by hand before you next use the appliance.

1. Remove and empty the water tank.
2. Clean the water tank thoroughly.
3. Fill the water tank with 1.7 l water and insert it into the appliance.
4. Press **✓** to confirm.
5. Press **▶** to start the rinsing process.

Drying the oven cavity

1. After descaling the oven cavity, use the drying program → *Page 34* to dry it.
2. Remove the tank.
3. Dry the tank with a soft cloth.

16.7 Removing the shelf supports

The shelf supports can be removed for cleaning.

1. Place a dishcloth in the oven cavity to protect the stainless steel from scratches.
2. Undo the knurled nuts.

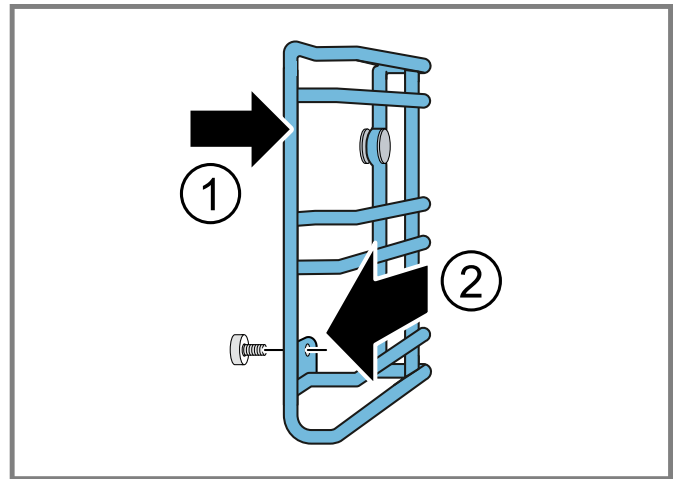
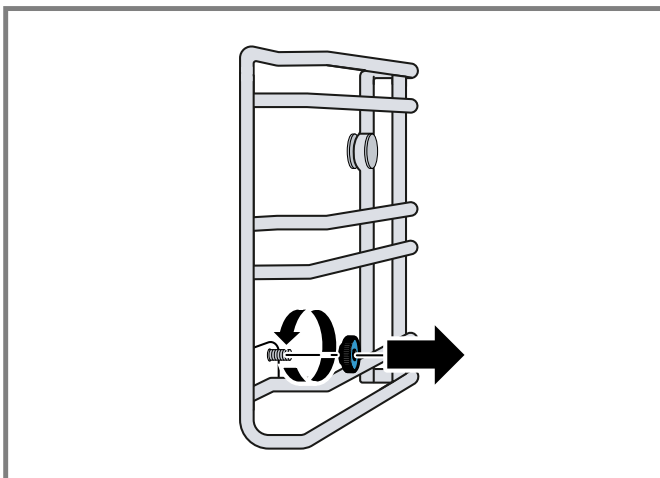

4. Clean the shelf supports in hot soapy water or in the dishwasher.

16.8 Fitting the shelf supports

NOTICE:

Incorrect spare parts may lead to corrosion in the oven cavity.

- ▶ Only use the original knurled nuts.

1. Fit the shelf supports the right way round.
 - Position the stop in the rear of the cooking compartment.
2. Slide the back of the shelf supports onto the bolts and attach them at the front.
3. Tighten the knurled nuts.

Note: If you lose a knurled nut, you can order this as a spare part from our customer service.

17 Troubleshooting



You can eliminate minor issues on your appliance yourself. Please read the information on eliminating issues before contacting Customer Service. This may avoid unnecessary repair visits.

WARNING

Improper repairs are dangerous.

- ▶ Repairs to the appliance should only be performed by authorized service providers.

- ▶ If the power cord of this appliance becomes damaged, it must be replaced by the manufacturer, the manufacturer's Customer Service, or an authorized service provider in order to prevent injury.
- ▶ Only original spare parts may be used to repair the appliance.
- ▶ If the appliance has an issue, call Customer Service.

Issue	Cause and troubleshooting
The appliance is not working.	<p>The plug for the power cord is not plugged in.</p> <ul style="list-style-type: none"> ▶ Connect the appliance to the power supply. <hr/> <p>The circuit breaker in the circuit breaker panel has tripped.</p> <ul style="list-style-type: none"> ▶ Check the breaker panel. <hr/> <p>There has been a power failure.</p> <ul style="list-style-type: none"> ▶ Check whether the lighting in your kitchen or other appliances in the room are working. <hr/> <p>Operating error.</p> <ul style="list-style-type: none"> ▶ Switch off the circuit breaker for the appliance in the fuse box and switch it back on after approximately 60 seconds.
The appliance is not working. Display shows "Appliance locked. Descaling required."	<p>Build-up of limescale in the appliance.</p> <ul style="list-style-type: none"> ▶ Start the descaling program → <i>Page 35</i>.
Despite descaling, "Please descale" appears on the display.	<p>Build-up of limescale in the appliance, incorrect descaler used.</p> <ol style="list-style-type: none"> 1. Use the specified descaling tablets. 2. Start the descaling program → <i>Page 35</i>.
The appliance does not start.	<p>The appliance door is not fully closed.</p> <ul style="list-style-type: none"> ▶ Close the appliance door.
The appliance cannot be started via the Home Connect® app.	<p>The appliance is not connected to the Home Connect® app.</p> <ul style="list-style-type: none"> ▶ Start the connection between the appliance and the Home Connect® app. → <i>"Setting up Home Connect®", Page 26</i> <hr/> <p>The appliance is connected to the Home Connect® app but the remote control function is not activated.</p> <ul style="list-style-type: none"> ▶ Activate the remote control function in the Home Connect settings. <hr/> <p>The function selector is not located at the light position.</p> <ul style="list-style-type: none"> ▶ Turn the function selector to the light position.
The appliance is not working. The display shows E182.	<p>The appliance does not receive water.</p> <ol style="list-style-type: none"> 1. Check the water tank. → <i>Page 39</i> 2. If the display shows the error message again, contact customer service → <i>Page 40</i>.
The appliance is not working. The display does not respond. The display shows the symbol for the childproof lock  .	<p>Childproof lock is activated.</p> <ul style="list-style-type: none"> ▶ Deactivate the childproof lock. → <i>Page 20</i>
The appliance automatically switches off.	<p>Safety switch-off function: No operation for more than 12 hours.</p> <ol style="list-style-type: none"> 1. Press  to confirm the message. 2. Switch off the appliance.
The appliance does not heat up; the display shows the symbol for the demo mode  .	<p>The appliance is in demo mode.</p> <ul style="list-style-type: none"> ▶ Deactivate the demo mode in the basic settings → <i>Page 28</i>.

Issue	Cause and troubleshooting
The appliance cannot be started; the display shows a message.	No water at the appliance. ▶ Check the water connection.
The core temperature probe is inserted; the display shows 210 °F (99 °C).	Moisture on the core temperature probe plug or on the socket in the oven cavity. ▶ Insert and remove the plug for the core temperature probe in the socket in the oven cavity several times.
The core temperature probe is inserted, but the display does not show the core temperature probe symbol  .	Moisture on the socket in the oven cavity. ▶ Insert and remove the plug for the core temperature probe in the socket in the oven cavity several times.
No steam is visible.	Water vapor above 212 °F (100 °C) is not visible. ▶ This is normal. No action required.
"Steam removal" function does not work.	Steam removal is only possible if the temperature in the oven cavity is below 265 °F (130 °C). ▶ This is normal.
Powerful steam release at the top of the door.	You have changed the operating mode. ▶ This is normal. No action required.
Powerful steam release at the side of the door.	The door seal is dirty or loose. 1. Clean the door seal. 2. Insert the door seal into the groove.
Humming noise when switching on.	The drain pump starts running. ▶ Normal operating noise No action required. The appliance has been switched off for a few days. Automatic rinsing during initial use. ▶ Normal: Automatic rinsing during initial use. No action required.
A whistling noise occurs during heating.	Noises may occur during steam generation. ▶ This is normal. No action required.
A "plop" sound can be heard during cooking.	Tension expansion when the temperature difference is large. ▶ This is normal. No action required.
Steaming is not possible.	Build-up of limescale in the appliance. The appliance must be descaled to avoid damage to the appliance. ▶ Start the descaling program → <i>Page 35</i> .
The appliance is no longer producing steam correctly.	Build-up of limescale in the appliance. ▶ Start the descaling program → <i>Page 35</i> .
The lighting does not work.	The lighting is defective. ▶ Call → " <i>Customer Service</i> ", <i>Page 40</i> .
The display shows the error message "Exx".	An error occurred. 1. If the display shows an error message, turn the function selector to 0. ✓ If the display no longer shows the error message, it was a one-off problem. 2. If the display continues to show or repeatedly shows the error message, contact customer service → <i>Page 40</i> and provide them with the error code.
Water drips out when you open the appliance door.	The collecting channel on the underside of the door pane is full. ▶ Dry the collecting channel with a sponge.

Issue	Cause and troubleshooting
An unpleasant smell occurs during heating.	<p>The appliance is new.</p> <ul style="list-style-type: none"> ▶ Before using it for the first time, heat the appliance at 60% humidity  and 395 °F (200 °C) for one hour. <p>→ "Heating up the appliance", Page 17</p>

17.1 Power failure





Your appliance can bridge a power failure of a few seconds. The operation continues.

If the power failure lasts longer and the appliance was operating, the display shows a message. The operation is interrupted.

Switch the appliance back on again after a power failure

1. Turn the function selector to 0.
2. Switch the appliance back on again as usual.

17.2 Check the water tank

1. Turn the function selector to 0.
2. Remove the water tank.
3. Remove the tank lid.
4. Remove the suction hose  and clean it under running water.
5. Check whether the suction hose is free of residues.
6. Check whether the filter  is free of residues at the discharge valve .
7. Fully fit the suction hose .
 - Ensure that the suction hose is not kinked.

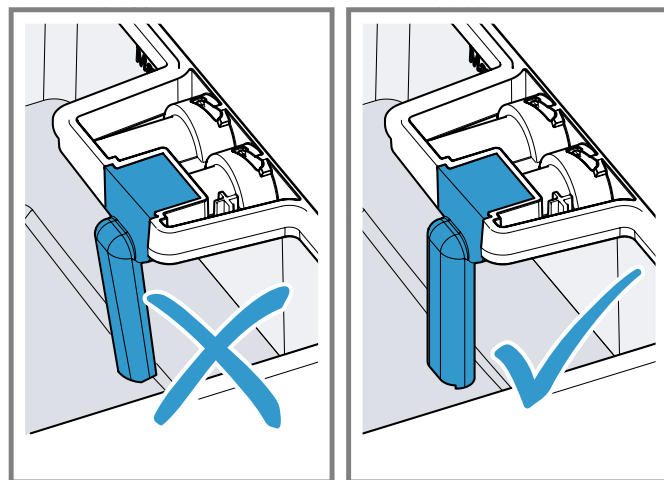
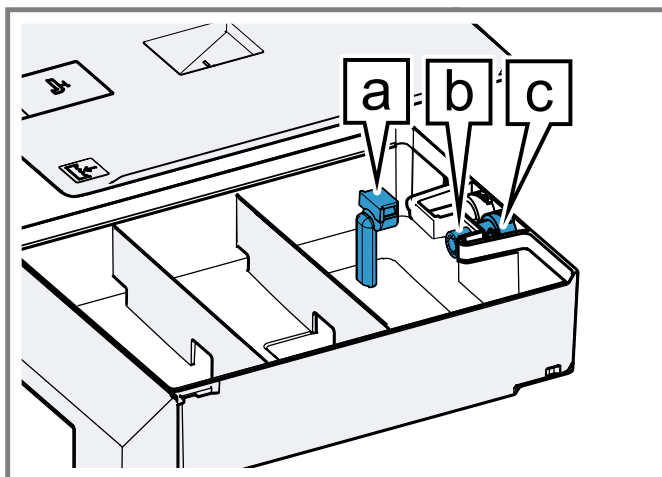

8. Fit the tank lid.

17.3 Demo mode

If the display shows , demo mode is activated. The appliance does not heat up.

Deactivating demo mode

1. To briefly disconnect the appliance from the mains, switch off the household fuse or the circuit breaker in the fuse box.
2. Deactivate demo mode within 3 minutes in the basic settings → Page 28.

18 Disposal

18.1 Disposal of your old appliance

Environmentally compatible disposal allows valuable raw materials to be recycled.

1. Unplug the appliance from the power supply.
2. Cut through the power cord.

3. Dispose of the appliance in an environmentally responsible manner.

Information about current disposal methods can be obtained from your specialist dealer or local authority.

19 Customer Service

With any warranty repair, we will make sure your appliance is repaired by an authorized service provider using genuine replacement parts. We use only genuine replacement parts for all repairs.

Detailed information on the warranty period and terms of warranty can be found in the Statement of Limited Product Warranty, from your retailer, or on our website.

If you contact Customer Service, you will need the model number (E-Nr.) and the production number (FD) of your appliance.

The LED light sources are available as a spare part and should only be replaced by an authorized service provider.
USA:

1-877-442-4436

www.gaggenau.com

www.gaggenau.com/us/appliances/eshop

CA:

1-877-442-4436

www.gaggenau.com

www.gaggenau.ca

For assistance with connecting to Home Connect®, you can also view instructions here:

www.home-connect.com/us/en/help-support/set-up

19.1 Model number (E-Nr.) and production number (FD)

You can find the model number (E-Nr.) and the production number (FD) on the appliance's rating plate.

You can see the rating plate with these numbers when you open the appliance door.

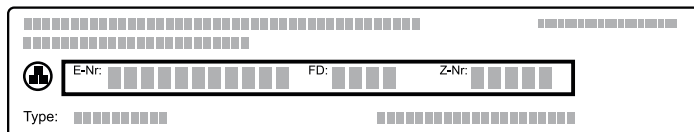

Making a note of your appliance's details and the Customer Service telephone number will enable you to find them again quickly.

19.2 Rating plate location

You can find the rating plate of your appliance:

- inside of the appliance door.

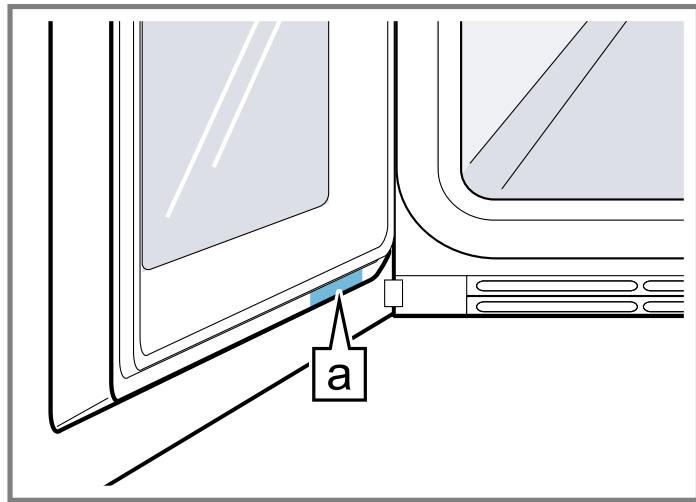

a Rating plate

20 STATEMENT OF LIMITED PRODUCT WARRANTY

20.1 What this warranty covers & Who it applies to

The limited warranty provided by BSH Home Appliances ("Gaggenau") in this Statement of Limited Product Warranty applies only to the Gaggenau appliance sold to you ("Product"), provided that the Product was purchased:

- For your normal, household (non-commercial) use, and has in fact at all times only been used for normal household purposes.
- New at retail from a BSH authorized dealer or directly from BSH (not a display, "as is", or previously returned model), and not for resale, or commercial use.
- Within the United States or Canada, and has at all times remained within the country of original purchase.

The warranties stated herein apply to the original purchaser of the product warranted herein and to each succeeding owner of the product purchased for ordinary home use during the term of the warranty.

Please make sure to register your Product; while not necessary to effectuate warranty coverage, it is the best way for Gaggenau to notify you in the unlikely event of a safety notice or product recall.

20.2 How long the warranty lasts

Gaggenau warrants that the Product is free from defects in materials and workmanship for a period of seven hundred and thirty (730) days from the date of the original delivery. The foregoing timeline begins to run upon the date of original delivery, and shall not be stalled, tolled, extended, or suspended, for any reason whatsoever. This Product is also warranted to be free from **cosmetic** defects in material and workmanship (such as scratches of stainless steel, paint/porcelain blemishes, chips, dents, or other damage to the finish) of the Product, for a period of sixty (60) days from the date of delivery or closing date for new

construction. This **cosmetic** warranty excludes slight color variations due to inherent differences in painted and porcelain parts, as well as differences caused by kitchen lighting, product location, or other similar factors. This **cosmetic** warranty specifically excludes any display, floor, "As Is", or "B" stock appliances.

20.3 Repair/replace as your exclusive remedy

During this warranty period, Gaggenau or one of its authorized service providers will repair your Product without charge to you (subject to certain limitations stated herein) if your Product proves to have been manufactured with a defect in materials or workmanship. If reasonable attempts to repair the Product have been made without success, then Gaggenau will replace your Product (upgraded models may be available to you, in Gaggenau's sole discretion, for an additional charge). Nothing in this warranty requires damaged or defective parts to be replaced with parts of a different type or design than the original parts. All removed parts and components shall become the property of Gaggenau at its sole option. All replaced and/or repaired parts shall assume the identity of the original part for purposes of this warranty and this warranty shall not be extended with respect to such parts. Gaggenau's sole liability and responsibility hereunder is to repair manufacturer-defective Product only, using a Gaggenau authorized service provider during normal business hours. For safety and property damage concerns, Gaggenau highly recommends that you do not attempt to repair the Product yourself, or use a non-authorized service provider; Gaggenau will have no responsibility or liability for damage resulting from repairs or work performed by a non-authorized service provider. Authorized service providers are those persons or companies that have been specially trained on Gaggenau products, and who possess, in Gaggenau's opinion, a superior reputation for customer service and technical ability (note that they are independent entities and are not agents, partners, affiliates or representatives of Gaggenau). Nevertheless, taking your product to be serviced by a repair shop that is not affiliated with or an authorized dealer of Gaggenau will not void this warranty. Also, using third-party parts will not void this warranty. Notwithstanding the foregoing, Gaggenau will not incur any liability, or have responsibility, for the Product if it is located in a remote area (more than 100 miles from an authorized service provider) or is reasonably inaccessible, hazardous, threatening, or treacherous locale, surroundings, or environment; in any such event, if you request, Gaggenau would still pay for labor and parts and ship the parts to the nearest authorized service provider, but you would still be fully liable and responsible for any travel time or other special charges by the service company, assuming they agree to make the service call. Further, to the extent you have installed the Product in a difficult-to-access location or have otherwise installed temporary or permanent fixtures that create barriers to accessing or removing the Product, Gaggenau will not

incur any liability for, or have responsibility, for work or costs associated with moving the Product or otherwise creating access to the Product in order to repair or replace it. All such costs shall be your sole responsibility.

20.4 Out of warranty product

Gaggenau is under no obligation, at law or otherwise, to provide you with any concessions, including repairs, prorates, or Product replacement, once this warranty has expired.

20.5 Warranty exclusions

The warranty coverage described herein excludes all defects or damage that are not the direct fault of Gaggenau, including without limitation, one or more of the following:

- Use of the Product in anything other than its normal, customary and intended manner (including without limitation, any form of commercial use, use or storage of an indoor product outdoors, use of the Product in conjunction with air or water-going vessels).
- Any party's willful misconduct, negligence, misuse, abuse, accidents, neglect, improper operation, failure to maintain, improper or negligent installation, tampering, failure to follow operating instructions, mishandling, unauthorized service (including selfperformed "fixing" or exploration of the appliance's internal workings).
- Adjustment, alteration or modification of any kind.
- A failure to comply with any applicable state, local, city, or county electrical, plumbing and/or building codes, regulations, or laws, including failure to install the product in strict conformity with local fire and building codes and regulations.
- Ordinary wear and tear, spills of food, liquid, grease accumulations, or other substances that accumulate on, in, or around the Product.
- Any external, elemental and/or environmental forces and factors, including without limitation, rain, wind, sand, floods, fires, mud slides, freezing temperatures, excessive moisture or extended exposure to humidity, lightning, power surges, structural failures surrounding the appliance, and acts of God.
- Service calls to correct the installation of your Product, to instruct you how to use your Product, to replace house fuses or correct house wiring or plumbing.
- Removal and replacement of trim or decorative panels that interfere with servicing the Product.
- Damage or defects caused by labor or parts installed by any non-authorized service provider, unless approved by Gaggenau before service is performed.

In no event shall Gaggenau have any liability or responsibility whatsoever for damage to surrounding property, including cabinetry, floors, ceilings, and other structures or objects around the Product. Also excluded from this warranty are Products, on which the serial numbers have been altered, defaced, or removed; service visits to teach you how to use the Product, or visits where there is nothing wrong with the Product; correction of

installation problems (you are solely responsible for any structure and setting for the Product, including all electrical, plumbing or other connecting facilities, for proper foundation/flooring, and for any alterations including without limitation cabinetry, walls, floors, shelving, etc.); and resetting of breakers or fuses. TO THE EXTENT ALLOWED BY LAW, THIS WARRANTY SETS OUT YOUR EXCLUSIVE REMEDIES WITH RESPECT TO PRODUCT, WHETHER THE CLAIM ARISES IN CONTRACT OR TORT (INCLUDING STRICT LIABILITY, OR NEGLIGENCE) OR OTHERWISE. THIS WARRANTY IS IN LIEU OF ALL OTHER WARRANTIES, WHETHER EXPRESS OR IMPLIED. ANY WARRANTY IMPLIED BY LAW, WHETHER FOR MERCHANTABILITY OR FITNESS FOR A PARTICULAR PURPOSE, OR OTHERWISE, SHALL BE EFFECTIVE ONLY FOR THE PERIOD THAT THIS EXPRESS LIMITED WARRANTY IS EFFECTIVE. IN NO EVENT WILL THE MANUFACTURER BE LIABLE FOR CONSEQUENTIAL, SPECIAL, INCIDENTAL, INDIRECT, "BUSINESS LOSS", AND/OR PUNITIVE DAMAGES, LOSSES, OR EXPENSES, INCLUDING WITHOUT LIMITATION TIME AWAY FROM WORK, HOTELS AND/OR RESTAURANT MEALS, REMODELLING EXPENSES IN EXCESS OF DIRECT DAMAGES WHICH ARE DEFINITELY CAUSED EXCLUSIVELY BY GAGGENAU, OR OTHERWISE. SOME STATES DO NOT ALLOW THE EXCLUSION OR LIMITATION OF INCIDENTAL OR CONSEQUENTIAL DAMAGES, AND SOME STATES DO NOT ALLOW LIMITATIONS ON HOW LONG AN IMPLIED WARRANTY LASTS, SO THE ABOVE EXCLUSIONS OR LIMITATIONS MAY NOT APPLY TO YOU. THIS WARRANTY GIVES YOU SPECIFIC LEGAL RIGHTS, AND YOU MAY ALSO HAVE OTHER RIGHTS WHICH VARY FROM STATE TO STATE.

No attempt to alter, modify or amend this warranty shall be effective unless authorized in writing by an officer of BSH.

20.6 Obtaining warranty service

To obtain warranty service for your product, you should contact Gaggenau Customer Support at 1-877-442-4436 to schedule a repair.

20.7 Product information

For handy reference, copy the information below from the rating plate. Keep your invoice and/or delivery documents for warranty validation.

Model number (E-Nr.)

Production number
(FD)

Date of delivery



A series of horizontal lines spanning the width of the page, providing a template for writing.

BSH Home Appliances Corporation
1901 Main Street, Suite 600
Irvine, CA 92614
USA
www.gaggenau.com
1-877-442-4436
© 2024 BSH Home Appliances Corporation

GAGGENAU



9001699198 en-us (040529)