

**SIEMENS**

## Tumble dryer

WT47URH2ES

en Installation and operating instructions



Register your product on My Siemens and discover exclusive services and offers.

[siemens-home.bsh-group.com/welcome](https://siemens-home.bsh-group.com/welcome)

The future moving in.

Siemens Home Appliances

## Your new tumble dryer

You have opted for a tumble dryer manufactured by Siemens.

Please take a few minutes to read and become familiar with the advantages of your tumble dryer.

To meet the high quality demands required by Siemens, every tumble dryer that leaves our factory is carefully checked to ensure that it functions correctly and is in perfect condition.

For more information on our products, accessories, replacement parts and services, see our website [www.siemens-home.bsh-group.com](http://www.siemens-home.bsh-group.com) or contact our Customer Service centres.

If the operating and installation instructions describe different models, any differences will be pointed out at the relevant points in the text.



Read these operating and installation instructions before operating the tumble dryer.

## Display rules

### **Warning!**

This combination of symbol and signal word indicates a possibly dangerous situation. Not heeding the warning can cause death or injuries.

### **Caution!**

This signal word indicates a possibly dangerous situation. Not heeding the caution can cause property and/or environmental damage.

### **Note/tip**

Information about the optimum use of the appliance/any other useful information.

### **1. 2. 3. / a) b) c)**









The steps are represented by numbers or letters.

■ / -

Lists are represented by a small box or a dash.

# Table of contents

 <b>Intended use</b> . . . . .	4	 <b>Operating the appliance</b> . . . . .	29
 <b>Safety instructions</b> . . . . .	5	Loading laundry and switching on the appliance . . . . .	29
Children/people/pets . . . . .	5	Setting a programme . . . . .	30
Installation . . . . .	6	Starting the programme . . . . .	30
Operation . . . . .	8	Programme progress . . . . .	30
Cleaning/Maintenance . . . . .	11	Changing the programme or adding more laundry . . . . .	30
 <b>Energy-saving tips</b> . . . . .	12	Cancelling the programme . . . . .	31
 <b>Installing and connecting the appliance</b> . . . . .	13	End of programme . . . . .	31
Scope of delivery . . . . .	13	Removing laundry and switching off the appliance . . . . .	31
Installing the appliance . . . . .	13	Emptying the condensation container . . . . .	31
Connecting the appliance . . . . .	15	Removing the fluff . . . . .	32
Before using the appliance for the first time . . . . .	16	 <b>Appliance settings</b> . . . . .	34
Optional accessories . . . . .	16	Childproof lock . . . . .	34
 <b>Quick reference guide</b> . . . . .	17	Quiet drying . . . . .	34
 <b>Familiarising yourself with your appliance</b> . . . . .	18	Altering the appliance settings . . . . .	34
Appliance overview . . . . .	18	 <b>Home Connect</b> . . . . .	36
Fascia . . . . .	19	Calling up the Home Connect menu . . . . .	37
 <b>Display</b> . . . . .	20	Connecting to the home network and the Home Connect app . . . . .	37
 <b>Overview of programmes</b> . . . . .	23	Activating/deactivating Wi-Fi . . . . .	39
 <b>Programme settings</b> . . . . .	25	Resetting your network settings . . . . .	40
 <b>Laundry</b> . . . . .	28	Updating the software . . . . .	40
Preparing laundry . . . . .	28	Energy management . . . . .	41
Sorting laundry . . . . .	28	Information on data protection . . . . .	42
		Declaration of Conformity . . . . .	42
		 <b>Drying with the basket for woollens</b> . . . . .	43
		The basket for woollens . . . . .	43
		Securing the basket for woollens . . . . .	43
		Application examples . . . . .	43
		Putting the insert in place and starting a programme . . . . .	44

	<b>Draining the condensation water</b> .....	<b>45</b>
	<b>Cleaning and maintenance</b> ...	<b>48</b>
	Cleaning the appliance .....	48
	Cleaning the moisture sensor .....	48
	Cleaning the filter in the condensation container .....	49
	Cleaning the base unit. ....	50
	<b>Appliance care</b> .....	<b>52</b>
	Preparing the appliance for appliance care. ....	52
	Running the basic appliance care programme .....	54
	Running the intensive appliance care programme .....	55
	<b>Help with the appliance</b> .....	<b>58</b>
	<b>Transporting the appliance</b> ...	<b>61</b>
	<b>Consumption values</b> .....	<b>62</b>
	Consumption values table .....	62
	Most efficient programme for cotton laundry .....	62
	<b>Technical data</b> .....	<b>63</b>
	<b>Disposal</b> .....	<b>63</b>
	<b>Customer Service</b> .....	<b>64</b>

---

## Intended use

- This appliance is intended for private domestic use only.
- Do not install or operate this appliance anywhere that is liable to experience frost and/or outdoor conditions. There is a risk that the appliance will be damaged if residual water in it freezes. If hoses freeze up, they may crack/burst.
- This appliance must only be used for drying and freshening up domestic laundry, consisting of items that have been washed with water and are suitable for tumble drying (see label on item). Using the appliance for any other purpose is outside of the scope of its intended application and is forbidden.
- This appliance is intended for use up to a maximum height of 2000 metres above sea level.

### **Before you switch on the appliance:**

Check that there is no visible damage to the appliance. Do not operate the appliance if it is damaged. Should you have any problems, please contact your specialist dealer or our customer service.

Read and follow the operating and installation instructions and all other information provided with this appliance.

Retain the documents for subsequent use or for subsequent owners.

## Safety instructions

The following safety information and warnings are provided to protect you from injury and to prevent material damage to your surroundings.

It is nevertheless important to take the necessary precautions and to proceed with care when installing, maintaining, cleaning and operating the appliance.

### Children/people/pets

#### **Warning** **Risk of death!**

Children and other people who are unable to assess the risks involved when using the appliance may injure themselves or may find themselves in life-threatening situations. Therefore please note:

- The appliance may be used by children over the age of 8 years and by persons with reduced physical, sensory or mental capacity or by persons with a lack of experience or knowledge as long as they are supervised or have received instruction on how to use the appliance safely and they have understood the potential risks of using the appliance.
- Children must not play with this appliance.

- Do not allow children to clean or maintain this appliance unsupervised.
- Keep children under 3 years and pets away from this appliance.
- Do not leave the appliance unattended when children or other people who are unable to assess the risks are in the vicinity.

#### **Warning** **Risk of death!**

Children may lock themselves inside appliances and find themselves in a life-threatening situation.

- Do not position the appliance behind a door, as this may obstruct the appliance door or prevent it from opening completely.
- Once an appliance has reached the end of its life, pull the mains plug from the socket **before** severing the mains cable, and then destroy the lock on the appliance door.

#### **Warning** **Risk of suffocation!**

If allowed to play with the packaging/plastic film or packing components, children may become caught in these or pull them over their heads and suffocate.

Keep packaging, plastic film and packing components away from children.

 **Warning**

**Risk of poisoning!**

Detergents and care products may result in poisoning if consumed.

If accidentally swallowed, seek medical advice. Keep detergents and care products out of the reach of children.

 **Warning**

**Eye/skin irritation!**

Contact with detergents or care products may cause eye/skin irritation.

Rinse eyes/skin thoroughly if they/it come(s) into contact with detergents or care products. Keep detergents and care products out of the reach of children.

## Installation

 **Warning**

**Risk of electric shock/fire/  
material damage/damage to  
the appliance!**

If the appliance is not installed properly, this may lead to a dangerous situation. Ensure the following:

- The mains voltage on your power socket must match the rated voltage specified on the appliance (identification plate). The connected loads and the required fuse protection are specified on the identification plate.
- The appliance must not be supplied through an external switching device, such as a timer, or connected to a circuit that is regularly switched on and off by a utility.
- The mains plug and the protective contact socket must match and the earthing system must be correctly installed.
- The installation must have an adequate cross section.
- The mains plug must be freely accessible at all times. If this is not possible, in order to comply with the relevant safety regulations, a switch (all pole disconnection) must be built into the permanent installation in accordance with electrical installation regulations.

- If using a residual current circuit breaker, only use one that bears the following mark: . The presence of this mark is the only way to be sure that it fulfils all the applicable regulations.

### **Warning**

#### **Risk of electric shock/fire/material damage/damage to the appliance!**

If the appliance's mains cable is altered or damaged, this may result in electric shock, short circuiting or fire due to overheating.

The mains cable must not be kinked, crushed or altered, and must not come into contact with any heat sources.

### **Warning**

#### **Risk of fire/material damage/damage to the appliance!**

The use of extension cords or power strips may result in fire due to overheating or short circuiting.

Connect the appliance directly to an earthed socket that has been correctly installed. Do not use extension cords, power strips or multi-way couplers.

### **Warning**

#### **Risk of injury/material damage/damage to the appliance!**

- The appliance may vibrate or move when in operation, potentially resulting in injury or material damage. Place the appliance on a clean, even, solid surface and, using a spirit level to guide you, level it with the screw-in feet.
- Incorrectly placing (stacking) this appliance on top of a washing machine may result in injury, material damage and/or damage to the appliance. If this appliance is to be placed on top of a washing machine, the washing machine must be of at least the same depth and width as the appliance, and it must be secured in place with the appropriate connection set if available. → *Page 16* The appliance **MUST** be secured with this connection set. Stacking the appliance in any other way is forbidden.
- If you take hold of any of the appliance's protruding parts (e.g. the appliance door) in order to lift or move it, these parts may break off and cause injury. Do not take hold of any of the appliance's protruding parts in order to move the appliance.



## **Warning**

### **Risk of injury!**

- The appliance is very heavy. Lifting it may result in injury. Do not lift the appliance on your own.
- The appliance has sharp edges on which you could cut your hands. Do not take hold of the appliance by its sharp edges. Wear protective gloves to lift it.
- If the hoses and mains cables are not correctly routed, they may constitute a tripping hazard, which may result in injury. Route hoses and cables such that they do not constitute a tripping hazard.

## **Operation**

### **Warning**

#### **Risk of explosions/fire!**

Laundry that has come into contact with solvents, oil, wax, wax remover, paint, grease or stain remover may ignite when dried in the machine, or even cause the appliance to explode. Therefore please note:

- Rinse the laundry thoroughly with warm water and detergent before drying it in the machine.
- Do not place laundry in this appliance to be dried if the laundry has not been washed first.
- Do not use the appliance if industrial chemicals have been used to clean the laundry.

### **Warning**

#### **Risk of explosions/fire!**

- If there is any residual material left in the fluff filter, this may ignite when drying is in progress, or even cause the appliance to catch fire or explode. Clean the fluff filter regularly.
- Certain objects may ignite when drying is in progress, or even cause the appliance to catch fire or explode. Remove any lighters or matches from pockets on items of clothing.



- If there is coal dust or flour in the air around the appliance, this may cause an explosion. Make sure that the area around the appliance is kept clean when it is in operation.

**⚠ Warning**

**Risk of fire/material damage/damage to the appliance!**

The appliance contains R290, a refrigerant that is environmentally friendly but flammable. Keep open fire and ignition sources away from the appliance.



**⚠ Warning**

**Risk of fire/material damage/damage to the appliance!**

If a program is terminated before the drying cycle has finished, this prevents the laundry from cooling down sufficiently and may cause the laundry to ignite, or may result in material damage or damage to the appliance.

- During the last part of the drying cycle, the laundry in the drum is not heated (cooling cycle). This is to ensure that it remains at a temperature at which it will not be damaged.

- Do not switch off the appliance before the drying cycle has finished unless you remove all items of laundry from the drum immediately and spread them out (to dissipate the heat).

**⚠ Warning**

**Risk of poisoning/material damage!**

Condensation water is not suitable for drinking and may be contaminated with lint. Contaminated condensation water may be hazardous to health and may cause material damage. Do not drink or reuse.

**⚠ Warning**

**Risk of poisoning!**

Poisonous fumes may be given off by cleaning agents that contain solvents, e.g. cleaning solvent. Do not use cleaning agents that contain solvents.

## **Warning**

### **Risk of injury!**

- If you support your weight/sit on the appliance door when it is open, the appliance may tip over, which may result in injury.

Do not support your weight on the appliance door when it is open.

- If you climb onto the appliance, the worktop may break, which may result in injury.

Do not climb onto the appliance.

- If you reach into the drum while it is still rotating, you risk injuring your hands. Wait until the drum has stopped rotating.

### **Caution!**

#### **Material damage/damage to the appliance**

- If the amount of laundry in the appliance exceeds its maximum load capacity, it may not be able to operate properly, or this may result in material damage or damage to the appliance.

Do not exceed the maximum load capacity of dry laundry. Make sure you comply with the maximum load capacities specified for each of the programs. → *Page 23*

- If you operate the appliance without a fluff catcher (e.g. fluff filter, fluff depot, depending on appliance specifications), or if the fluff catcher is incomplete or defective, this may result in damage to the appliance. Do not operate the appliance without a fluff catcher, or with a fluff catcher that is incomplete or defective.
- Light objects such as hair and lint may be sucked into the air inlet when the appliance is in operation. Keep these away from the appliance.
- Foam and foam rubber may deform or melt if dried in the appliance. Do not dry laundry items that contain foam or foam rubber in the appliance.
- If you pour the wrong quantity of detergent or cleaning agent into the appliance, this may result in material damage or damage to the appliance. Use detergents/care products/cleaning agents and softeners in accordance with the manufacturers' instructions.

- If the appliance overheats, it may not be able to operate properly, or this may result in material damage or damage to the appliance. Make sure that the appliance's air inlet is never obstructed when the appliance is in operation, and that the area around the appliance is adequately ventilated.

## Cleaning/Maintenance

### **Warning** **Risk of death!**

The appliance is powered by electricity. There is a risk of electric shock if you come into contact with live components. Therefore please note:

- Switch off the appliance. Disconnect the appliance from the power supply (pull out the plug).
- Never take hold of the mains plug with wet hands.
- When removing the mains plug from the socket, always take hold of the plug itself and never the mains cable, otherwise this may damage the mains cable.
- Do not make any technical modifications to the appliance or its features.

- Repairs and any other work on the appliance must only be conducted by our customer service or by an electrician. The same applies for replacing the mains cable (when necessary).
- Spare mains cables can be ordered from our customer service.

### **Warning** **Risk of poisoning!**

Poisonous fumes may be given off by cleaning agents that contain solvents, e.g. cleaning solvent.

Do not use cleaning agents that contain solvents.

### **Warning** **Risk of electric shock/material damage/damage to the appliance!**

If moisture penetrates the appliance, this may cause it to short circuit.

Do not use a pressure washer, steam cleaner, hose or spray gun to clean your appliance.

## Warning

### **Risk of injury/material damage/damage to the appliance!**

The use of spare parts and accessories supplied by other brands is dangerous and may result in injury, material damage or damage to the appliance.

For safety reasons, use genuine spare parts and accessories only.

## **Caution!**

### **Material damage/damage to the appliance**

Cleaning agents and agents for pretreating laundry (e.g. stain removers, prewash sprays, etc.) may cause damage if they come into contact with the surfaces of the appliance. Therefore please note:

- Do not allow these agents to come into contact with the surfaces of the appliance.
- Clean the appliance with nothing but water and a soft, damp cloth.
- Remove any detergent, spray or other residues immediately.



## **Energy-saving tips**

- Spin the laundry before drying. The drier the laundry, the shorter the programme will be, in turn reducing energy consumption.
- Load the appliance with the maximum loads permitted for the programmes.

**Note:** If the maximum load is exceeded, this extends the programme duration and increases energy consumption.

- Operate the appliance in a ventilated room and make sure that the air inlet on the appliance is unobstructed so that air exchange can take place unhindered.
- Regularly remove the fluff from the appliance. If there is fluff in the appliance, this extends the programme duration and increases energy consumption.
- If you do not perform any actions on the appliance for an extended period before the programme starts or once the programme has ended, the appliance will automatically switch to energy-saving mode. The display and indicator lights go out after a few minutes and ▷||| (Start/Pause) flashes. To end energy-saving mode, all you need to do is perform an action on the appliance, such as opening and closing the door.
- If you do not perform any actions on the appliance for an extended period when it is in energy-saving mode, the appliance automatically switches itself off.

**Note:** If Wi-Fi is activated, the appliance will not switch itself off automatically.



## Installing and connecting the appliance

### Scope of delivery

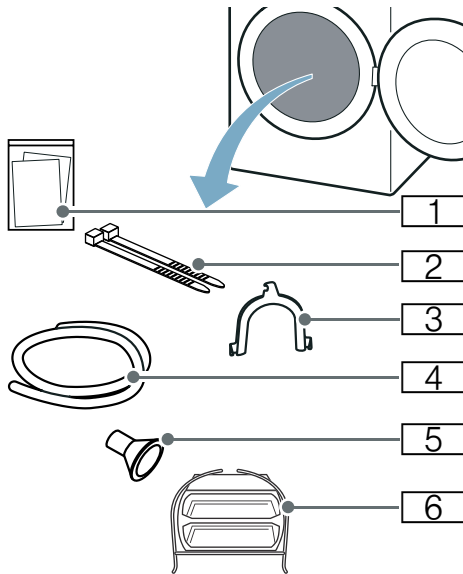

- 1 Accompanying documents (e.g. installation and operating instructions)
- 2 Fastening parts
- 3 U-piece for fixing the drain hose in place
- 4 Drain hose
- 5 Connection adapter
- 6 Basket for woollens

1. Remove any packaging and protective covers completely from the appliance.
2. Open the door.
3. Remove all the accessories from the drum.

You can now install and connect the appliance.

### Caution!

#### Risk of material damage and damage to the appliance

Objects remaining in the drum that are not designed for operation with the appliance may result in material damage and damage to the appliance. Remove these objects, along with all accessories, from the drum.

### Installing the appliance

#### **Warning** Risk of death!

Children may lock themselves inside appliances and find themselves in a life-threatening situation.

- Do not position the appliance behind a door, as this may obstruct the appliance door or prevent it from opening completely.
- Once an appliance has reached the end of its life, pull the mains plug from the socket **before** severing the mains cable, and then destroy the lock on the appliance door.

#### **Warning** Risk of explosions/fire!

If there is coal dust or flour in the air around the appliance, this may cause an explosion. Make sure that the area around the appliance is kept clean when it is in operation.

#### **Warning** Risk of fire/material damage/damage to the appliance!

The appliance contains R290, a refrigerant that is environmentally friendly but flammable. Keep open fire and ignition sources away from the appliance.



**⚠ Warning**

**Risk of injury/material damage/damage to the appliance!**

- The appliance may vibrate or move when in operation, potentially resulting in injury or material damage.

Place the appliance on a clean, even, solid surface and, using a spirit level to guide you, level it with the screw-in feet.

- Incorrectly placing (stacking) this appliance on top of a washing machine may result in injury, material damage and/or damage to the appliance.

If this appliance is to be placed on top of a washing machine, the washing machine must be of at least the same depth and width as the appliance, and it must be secured in place with the appropriate connection set if available.

→ Page 16

The appliance **MUST** be secured with this connection set. Stacking the appliance in any other way is forbidden.

- If you take hold of any of the appliance's protruding parts (e.g. the appliance door) in order to lift or move it, these parts may break off and cause injury. Do not take hold of any of the appliance's protruding parts in order to move the appliance.

**⚠ Warning**

**Risk of injury!**

- The appliance is very heavy. Lifting it may result in injury. Do not lift the appliance on your own.
- The appliance has sharp edges on which you could cut your hands. Do not take hold of the appliance by its sharp edges. Wear protective gloves to lift it.

**Caution!**

**Material damage/damage to the appliance**

If the appliance overheats, it may not be able to operate properly, or this may result in material damage or damage to the appliance.

Make sure that the appliance's air inlet is never obstructed when the appliance is in operation, and that the area around the appliance is adequately ventilated.

**Caution!**

**Risk of material damage and damage to the appliance**

The appliance underwent a function test before leaving the factory and therefore may contain residual water. This residual water may leak out if the appliance is tilted at an angle greater than 40°.

**Install the appliance as follows:**

1. Place the appliance on a clean, even, solid surface.
2. Check that the appliance is level using a spirit level.

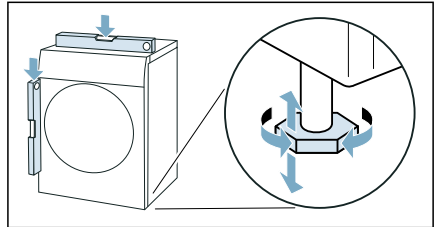

3. If necessary, turn the appliance feet to make sure it is level. You can now connect the appliance.

**Notes**

- All appliance feet must stand firmly on the ground.
- If the appliance is not aligned correctly, this may result in noises, vibrations, uneven drum operation and/or residual water leaking out of the appliance.

## Connecting the appliance

### **Warning**

#### **Risk of electric shock/fire/material damage/damage to the appliance!**

If the appliance is not installed properly, this may lead to a dangerous situation. Ensure the following:

- The mains voltage on your power socket must match the rated voltage specified on the appliance (identification plate). The connected loads and the required fuse protection are specified on the identification plate.
- The appliance must not be supplied through an external switching device, such as a timer, or connected to a circuit that is regularly switched on and off by a utility.
- The mains plug and the protective contact socket must match and the earthing system must be correctly installed.
- The installation must have an adequate cross section.
- The mains plug must be freely accessible at all times. If this is not possible, in order to comply with the relevant safety regulations, a switch (all pole disconnection) must be built into the permanent installation in accordance with electrical installation regulations.
- If using a residual current circuit breaker, only use one that bears the following mark: . The presence of this mark is the only way to be sure that it fulfils all the applicable regulations.

### **Warning**

#### **Risk of electric shock/fire/material damage/damage to the appliance!**

If the appliance's mains cable is altered or damaged, this may result in electric shock, short circuiting or fire due to overheating.

The mains cable must not be kinked, crushed or altered, and must not come into contact with any heat sources.

### **Warning**

#### **Risk of fire/material damage/damage to the appliance!**

The use of extension cords or power strips may result in fire due to overheating or short circuiting. Connect the appliance directly to an earthed socket that has been correctly installed. Do not use extension cords, power strips or multi-way couplers.

### **Warning**

#### **Risk of injury!**

If the hoses and mains cables are not correctly routed, they may constitute a tripping hazard, which may result in injury.

Route hoses and cables such that they do not constitute a tripping hazard.



en Installing and connecting the appliance

## Connect the appliance as follows:

1. Connecting the drain hose.  
→ Page 45

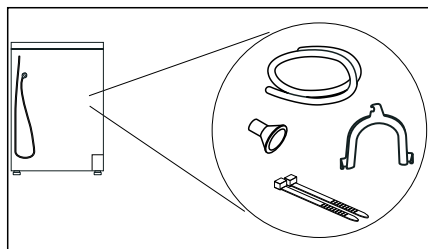

2. Plug the appliance's mains plug into the designated socket.
  3. Check that the mains plug is in securely.
- Your appliance is now ready to use.

### Caution!

#### Risk of material damage/damage to the appliance

The appliance contains refrigerant and may be damaged if it is operated immediately after transportation. Allow the appliance to rest for two hours before initial use.

**Note:** If in doubt, have your appliance connected by a qualified professional.

## Before using the appliance for the first time

### Before you switch on the appliance:

Check that there is no visible damage to the appliance. Do not operate the appliance if it is damaged. Should you have any problems, please contact your specialist dealer or our customer service.

**Note:** Once the appliance has been properly installed and connected, it is ready to use. No further steps are necessary.

## Optional accessories

Order optional accessories\* from the after-sales service:

- **Basket for woollens:**  
Dry or air individual woollen items, sports shoes and soft toys in the basket for woollens.  
– Order number: **WZ20600**.
- **Platform:**  
For easier loading and unloading, raise your dryer with a platform. You can transport laundry with the laundry basket integrated into the platform drawer.  
– Order number: **WZDP20D**.
- **Washer-dryer stack connection kit:**  
To save space, the dryer can be placed on top of a suitable washing machine of the same width and depth.  
Only this connection kit may be used to secure the dryer to the washing machine.  
– Order number with pull-out worktop: **WZ27400**  
– Order number without pull-out worktop: **WZ27410**.

\* Depending on the appliance features



## Quick reference guide

**Note:** The appliance must be correctly installed and connected. → *Page 13*

**1**

**Before starting the programme:**

The first row contains three icons. The first icon shows three boxes of laundry with arrows indicating sorting. The second icon shows a power button on a circular control panel with an arrow pointing to it. The third icon shows a dial on a circular control panel with an arrow pointing to it.

Sort the laundry.

Switch on the appliance.

Select a programme.

**2**

The second row contains four icons. The first icon shows a hand opening the appliance door. The second icon shows a hand closing the appliance door. The third icon shows a digital display showing '00:00' with an arrow pointing to it. The fourth icon shows a play button with a vertical bar, indicating starting the programme.

Open the door and place the laundry in the drum.

Close the door.

If necessary: Adjust the programme settings.

Start the programme.

**3**

**Once the programme has ended:**

The third row contains three icons. The first icon shows a power button on a circular control panel with an arrow pointing to it. The second icon shows a hand opening the appliance door. The third icon shows a hand pouring water from a condensation container.

Switch off the appliance.

Open the door and remove the laundry.

Empty the condensation container.

**4**

The fourth row contains one icon showing a hand pulling out a lint filter with water droplets, indicating the removal of fluff.

Remove the fluff.

## Familiarising yourself with your appliance

### Appliance overview

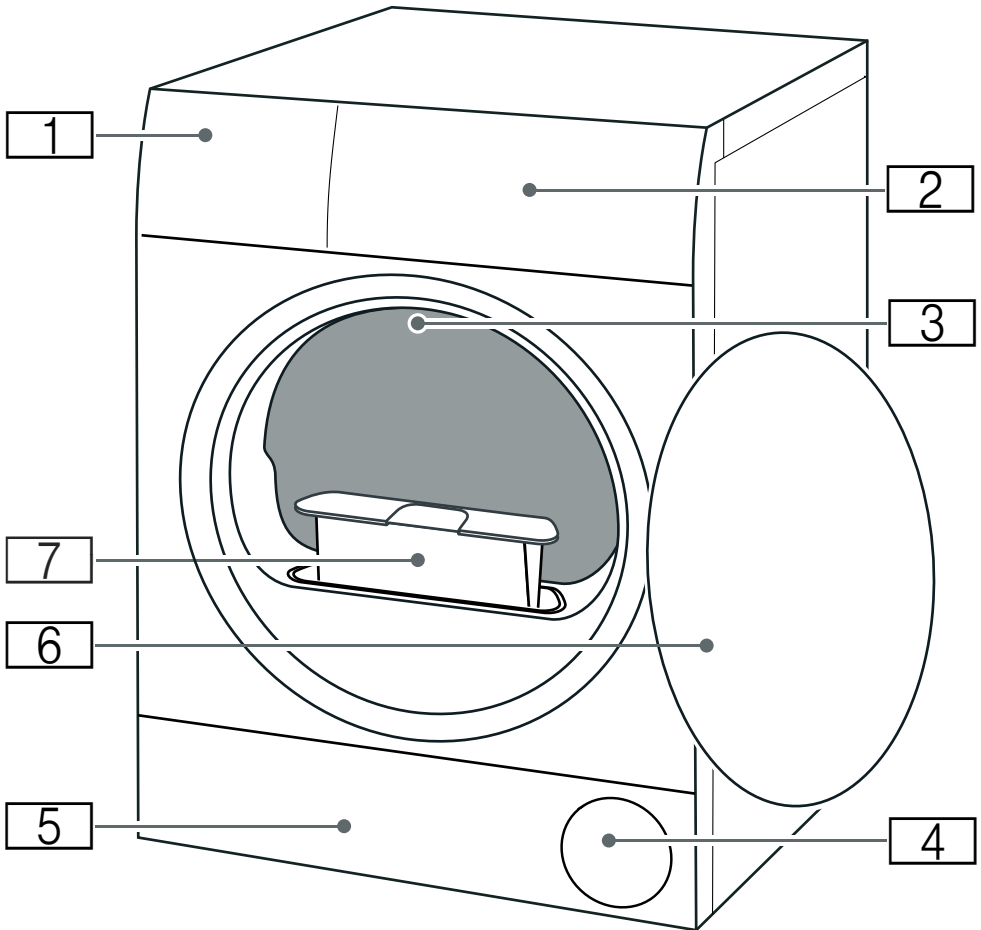

- 1** Condensation container
- 2** Control panel
- 3** Drum interior lighting (depending on the model)
- 4** Air inlet
- 5** Maintenance flap on the base unit
- 6** Door
- 7** Fluff filter

## Fascia

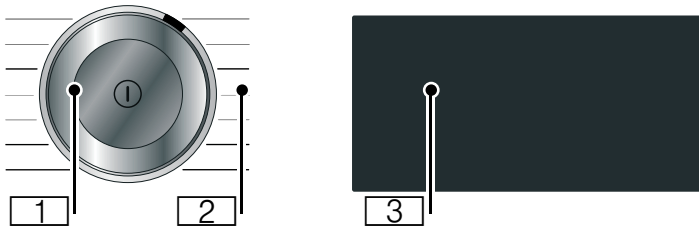

**1 Programme selector**

- Press to switch the appliance on/off
- Turn to set a programme

**2 Programmes:** → *Page 23*

**3 Display:**

The display on this appliance responds to touch (touch display).

- Operate the appliance by pressing buttons in boxes
- View settings and information

## Display

The display on this appliance responds to touch (touch display). You can activate settings by pressing lightly on the touch-sensitive buttons in boxes. The activated settings are illuminated particularly brightly to highlight them on the display. You can change or deactivate the activated settings by repeatedly pressing on the relevant buttons on the display.







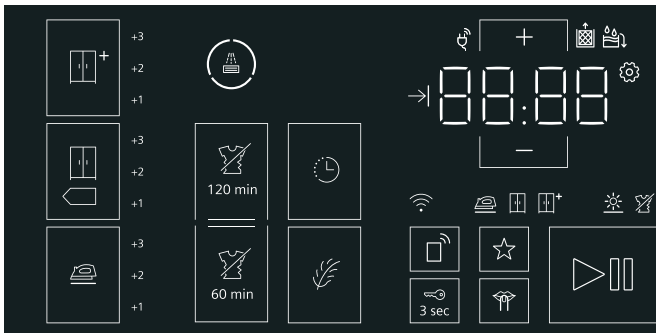











### Caution!



#### Material damage/damage to the appliance.

Exerting excessive pressure on the display may damage it. Do not use a sharp object on the display or exert excessive pressure on it.





Buttons	Explanation
+1; +2; +3	Dryness level: Cupboard Dry Plus Degree of dryness can be finely adjusted
+1; +2; +3	Dryness level: Cupboard Dry Degree of dryness can be finely adjusted
+1; +2; +3	Dryness level: Iron Dry Degree of dryness can be finely adjusted
120 min	Anti-Crease 120 min
60 min	Anti-Crease 60 min
	"Ready in" time
	Low-Heat Drying
	Favourite programme
3 sec	Childproof lock (press for 3 seconds) → Page 34
	Dry quietly without audible operating and notification signals → Page 34
	Remote start and Home Connect settings → Page 36

	Selection buttons	
		
	Start and Pause	
Detailed description of the programme settings from → Page 25		
Indicator/ symbol	Description	Information
	<b>Programme status:</b>	<b>Continuously lit:</b> Status indicator
	Drying	
	Dryness level: Iron Dry	
	Dryness level: Cupboard Dry	
	Dryness level: Cupboard Dry Plus	
	Anti-Crease	
	Pause	
	Program end	
	Programme duration	Expected programme duration in hours and minutes.
e.g. → 	Programme delay	Appears when altering and activating the "Ready in" time
	Empty the condensation container → Page 31	<ul style="list-style-type: none"> <li>■ Empty the condensation container and then reinsert it. → Page 31 Then press  (Start/Pause).</li> <li>■ Clean the filter in the condensation container.</li> <li>■ If the optional drain hose* is installed, make sure that the drain hose: <ul style="list-style-type: none"> <li>- Is correctly connected. → Page 45</li> <li>- Is not kinked or bent.</li> <li>- Is not blocked or clogged, e.g. by deposits.</li> </ul> </li> <li>■ Run the intensive appliance care programme.</li> <li>■ Check that no debris has found its way into the base unit. Open the maintenance flap and remove any debris.</li> </ul>
	Fluff filter	Remove the fluff → Page 32
	Automatic heat exchanger rinse	The heat exchanger is cleaned automatically. Do not pull out the condensation container or cancel the programme while this is displayed.
	Rinsing progress indicator	
	Wi-Fi	<ul style="list-style-type: none"> <li>■ <b>Off:</b> Wi-Fi is switched off and your appliance is not connected to your home network.</li> <li>■ <b>Flashing:</b> The appliance is trying to connect to your home network.</li> <li>■ <b>Lit:</b> Wi-Fi is switched on and your appliance is connected to your home network.</li> </ul>

	Energy manager	<b>Lit:</b> appliance is connected to the smart energy system (Energy manager) (not available in every country)
<b>CARE</b>	Basic appliance care programme	Not a fault. After a certain period, the appliance will automatically recommend that you run the basic appliance care programme. Run the basic appliance care programme. → <i>Page 54</i>
	Appliance settings	Alter the appliance settings → <i>Page 34</i>
<b>Hot</b>	CoolDown	<p>The appliance can reach high temperatures when drying. The CoolDown process reduces the temperature to prevent damage to the laundry when you:</p> <ul style="list-style-type: none"> <li>■ Pause the programme</li> <li>■ Cancel the programme</li> <li>■ Switch off the appliance via the app</li> </ul> <p>The CoolDown process does not start until 30 seconds after pausing/cancelling the programme or switching off the appliance via the app. You can continue to operate the appliance during the CoolDown process.</p> <p><b>Notes</b></p> <ul style="list-style-type: none"> <li>■ The drum continues to rotate during the CoolDown process, even if you have paused the programme.</li> <li>■ Do not change the programme during the CoolDown process.</li> <li>■ Temperature regulation can take up to 10 minutes.</li> </ul>

























## Overview of programmes

Programme	Maximum load
<b>Programme name</b> Brief explanation of the programme and the items for which it is suitable.	<b>Maximum load based on the dry weight of the items</b>
<b>algodón/algodão (Cottons)</b>  Hard-wearing items and heat-resistant items made of cotton or linen.	<b>9 kg</b>
<b>sinéticos (Synthetic)</b> Items made of synthetic or blended fabrics.	<b>3.5 kg</b>
<b>mix (Mixture)</b> Mixed load consisting of items made from cotton and synthetic fabrics.	<b>3 kg</b>
<b>lencería/lingerie (Lingerie)</b> Delicate, washable underwear, e.g. made from lace, Lycra, satin or blended fabrics.	<b>1 kg</b>
<b>secar c/cesto (Wool in Basket)</b> Items of laundry made of wool or that contain wool; shoes/sports shoes and trainers; washable soft toys made of polymer fibres. <b>Notes</b> <ul style="list-style-type: none"> <li>■ Dry the laundry only using the basket for woollens → <i>Page 43.</i></li> <li>■ Do not dry leather shoes or shoes with leather parts.</li> <li>■ The stuffing in the soft toys must also be suitable for tumble-drying.</li> </ul>	<b>Max. load for woollens/soft toys in the basket: 1 basket load</b>  <b>Max. load for shoes in the basket: 1 pair</b>
<b>frio (Cold)</b>  Timed programme for all types of fabric except for wool and silk. For loosening up or airing clothing that has hardly been worn. For drying individual items of laundry. <b>Note:</b> You can adjust the programme duration. → <i>"Programme settings" on page 25</i>	<b>3 kg</b>
<b>caliente/quente (Warm)</b>  Timed programme for all types of fabric except for wool and silk. Suitable for pre-dried or slightly damp laundry and for drying off multi-layered, thick laundry. For drying individual items of laundry. <b>Note:</b> In the timed programme, the laundry's remaining moisture is not automatically detected. If the laundry is still too damp when the drying programme has ended, repeat the programme and, if required, extend the programme duration. → <i>"Programme settings" on page 25</i>	<b>3 kg</b>

<p><b>camisas/business (Shirts/Business)</b></p> <p>Shirts/blouses made of cotton, linen, or synthetic or blended fabrics.</p> <p><b>Note:</b> Once the laundry is dry, iron it or hang it up. This will allow the residual moisture to be distributed evenly.</p>	<b>1.5 kg</b>
<p><b>edredones/edredões (Duvet)</b></p> <p>Clothing, pillows, quilts or bedspreads filled with synthetic fibres.</p> <p><b>Note:</b> Dry large items individually. Follow the instructions on the care label.</p>	<b>2.5 kg</b>
<p><b>almohadas/almofadas (Pillow)</b></p> <p>Pillows stuffed with down or synthetic fibres.</p> <p><b>Note:</b> Once the programme has ended, shake down-stuffed pillows to distribute the stuffing and eliminate any pockets of moisture. Restart the programme if necessary.</p>	<b>1 pillow</b>
<p><b>outdoor</b></p> <p>Weatherproof and outdoor clothing with a membrane coating and water-repellent fabrics.</p>	<b>1 item</b>
<p><b>toallas/toalhas (Towels)</b></p> <p>Hard-wearing towels and dressing gowns made of cotton.</p>	<b>6 kg</b>
<p><b>express 40'(Super 40)</b></p> <p>Mixed load of synthetic fabrics and light cottons.</p>	<b>2 kg</b>
<p><b>higiene (Hygiene)</b></p> <p>Hard-wearing items.</p> <p><b>Note:</b> The programme reaches high temperatures. Particularly suitable for strict hygiene requirements.</p>	<b>4 kg</b>

## **P+** Programme settings

Buttons	Indicators/ symbols	Explanations and notifications
<p><b>Note:</b> Not all buttons and their functions can be activated in every programme. The activated settings are illuminated particularly brightly to highlight them on the display. You can change or deactivate the activated settings by repeatedly pressing on the relevant buttons on the display.</p>		
<p> (Remote Start)</p>		<p>Pressing  (Remote Start) allows you to start the appliance remotely via the Home Connect app or to call up the Home Connect settings.</p> <p><b>Enabling the appliance to be started remotely via the Home Connect app:</b></p> <p><b>Note:</b> Remote start can only be activated if the appliance door is closed and the appliance is connected to your home network.</p> <ul style="list-style-type: none"> <li>■ Briefly press .                     <p><b>Note:</b> Remote start will be deactivated for safety reasons in the following circumstances:                      You open the door.                      There is a power failure.                      Once the programme has ended.                      If you press  (Start/Pause) on the appliance.                      If you briefly press  again.                      If you press  to switch off the appliance.</p> </li> </ul> <p><b>Calling up Home Connect settings:</b></p> <ul style="list-style-type: none"> <li>■ Press and hold  for at least 3 seconds.</li> </ul>
<p><b>Drying result :</b></p>		
<p> (Cupboard-dry plus)</p>	<p></p>	<p>Multi-layered, thick laundry that does not dry readily.</p>
<p>  (Cupboard-dry)</p>		<p>Normal, single-layered laundry.</p>
<p> (Iron Dry)</p>	<p></p>	<p>Normal, single-layered laundry that still needs to be damp after drying and is suitable for ironing or hanging up.</p>

<b>Adjust drying level</b>	+1 +2 +3	<p>If you think the laundry is still too damp when the drying programme has ended, you can adjust the degree of dryness to achieve a particular dryness level. To increase the dryness level, set the degree of dryness to between +1 and +3. This will extend the programme duration but the temperature will remain the same.</p> <p>Press a dryness level, e.g.  (Iron Dry), repeatedly until the required degree of dryness +1, +2, +3 is shown.</p> <p>Once you have adjusted the degree of dryness for a dryness level, this setting will be retained even after the appliance has been switched off.</p>
 (Ready in)	→0:5 - 24	<p><b>Before the programme starts</b>, you can use the "Ready in" time to set the time at which you want the programme to finish. This allows you to delay the end of the programme by up to 24 hours:</p> <ol style="list-style-type: none"> <li>1. Set the programme. The programme duration will be displayed for the selected programme, e.g. 00:45 (hours:minutes).</li> <li>2. Press  (Ready in). <b>Note:</b> You can use the + and - selection buttons to alter the setting values.</li> <li>3. Press  (Start/Pause). This will activate the "Ready in" time. Before the programme starts, the selected "Ready in" time (e.g. →00:45) is shown on the display and counts down until the drying programme starts. The duration of the programme will then be displayed.</li> </ol> <p><b>Note:</b> The programme duration is included in the "Ready in" time.</p>
	E.g. →0 : 40	<p>The drying time for <b>timed programmes</b> can be extended to up to 3 hours 30 minutes in 10-minute increments.</p> <p><b>Note:</b> You can use the + and - selection buttons to alter the setting values.</p>
 <b>60 min</b> (Anticrease 60 min)  <b>120 min</b> (Anticrease 120 min)		<p>The drum moves the laundry at regular intervals after drying to prevent creasing. You can activate the Anti-Crease function for 60 minutes (press  <b>60 min</b> (Anticrease 60 min)) or 120 minutes (press  <b>120 min</b> (Anticrease 120)), or you can deactivate this function.</p>
 (Low heat)		<p>Reduced temperature for delicate fabrics, e.g. polyacrylic or elastane; may increase the drying time.</p>

☆ (Favourite programme)

Press ☆ (Favourite programme) to save the settings and activate a programme with customised programme settings.

**Saving or overwriting a favourite programme:**

1. Set the programme you require.  
The programme settings will appear on the display.
2. Adjust the programme settings if required.
3. Press and hold ☆ (Favourite programme) for 3 seconds.

This programme with your customised programme settings has now been saved to your list of favourites.

**Note:** The selected settings will be retained even after the appliance has been switched off.

**Activating a favourite programme:**

1. Press ① to switch on the appliance.
2. Press ☆ (Favourite programme).

This favourite programme with your customised programme settings has now been activated.



## Laundry

### Preparing laundry



#### Warning

##### Risk of explosions/fire!

Certain objects may ignite when drying is in progress, or even cause the appliance to catch fire or explode. Remove any lighters or matches from pockets on items of clothing.

#### Caution!

##### Risk of damage to the drum and laundry

Leaving objects in the pockets of your clothing can cause damage to the drum and laundry when the appliance is in operation. Remove all objects (e.g. metal items) from clothing pockets.

Prepare the laundry as follows:

- Tie cloth belts, apron strings, etc. together or use a laundry bag.
- Close zips, hooks, eyelets and buttons. Button up large items of laundry, such as covers.
- Always dry very small items of laundry, e.g. babies' socks, together with large items such as towels.
- Use timed programmes for single items.
- Knitted items, such as T-shirts and jerseys, often shrink slightly the first time they are tumble-dried. Use a gentle programme.
- Do not overdry easy-care laundry. This leads to increased creasing of your laundry.

- Some detergents and care products, e.g. starch or softeners, contain particles that may accumulate on the moisture sensor. This may impair the sensor's performance and, in turn, the drying result.

#### Notes

- When washing laundry to be tumble-dried, use the correct amount of detergent and care products as specified in the manufacturer's instructions.
- Clean the moisture sensor regularly → *Page 48*.

### Sorting laundry

**Note:** Load the laundry item by item into the appliance. For more effective drying, do not stuff an entire bundle of laundry into the dryer at once.

#### Caution!

##### Risk of material damage to the dryer or laundry

Laundry that is unsuitable for tumble-drying may damage the appliance and the laundry when it is dried. Before you dry it, sort the laundry according to the information given on the care label:

- Suitable for tumble drying
- Dry at normal temperature
- Dry at low temperature
- Do not tumble-dry

When sorting the laundry to be dried, take the following points into account:

- To achieve an even drying result, only dry laundry of the same type of fabric and texture together. If you dry thin, thick and multi-layered fabrics together, they will dry to differing degrees.
- Use the fabric descriptions given for the individual drying programmes to help you choose the most appropriate programme.  
→ "Overview of programmes" on page 23  
→ "Drying with the basket for woollens" on page 43

**Note:** . You can select a timed programme to add extra drying time for laundry that is still damp.

**Caution!**  
**Risk of material damage to the appliance and laundry**

Do **not** tumble-dry the following items or fabrics in the appliance:

- Laundry contaminated with solvents, wax or grease.
- Unwashed items.
- Items made from non-breathable fabrics (e.g. rubber-coated).
- Items made from delicate fabrics, such as silk and curtains made of synthetic material.

 **Operating the appliance**

**Loading laundry and switching on the appliance**

**Note:** The appliance must be correctly installed and connected. → Page 13

1. Prepare and sort the laundry.
2. Press  to switch on the appliance.

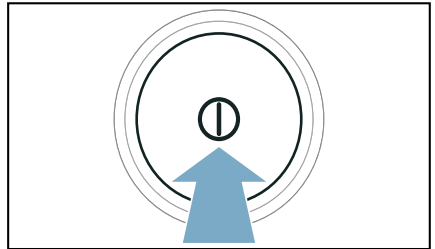

3. Open the door. Check that the drum has been completely emptied. Empty it if necessary.

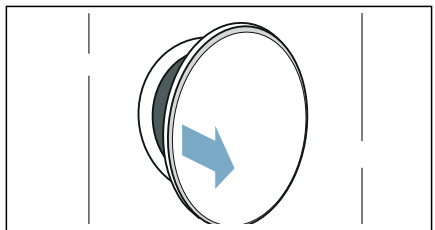

4. Load the laundry unfolded into the drum.

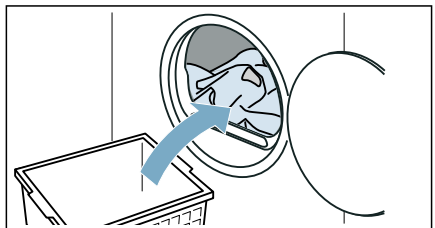



5. Close the appliance door.

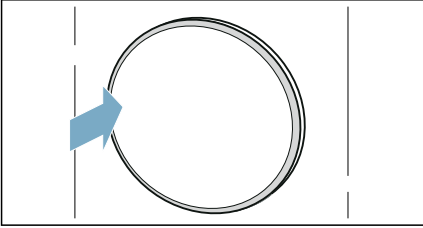

**Caution!**

**Risk of material damage to the appliance or laundry.**

Make sure that laundry is not trapped in the door.



**Note:** The appliance's drum is lit up after the door is opened and closed and once the programme has started. The drum's interior light goes out on its own (depending on model).

**Setting a programme**

**Note:** If you have activated the childproof lock, you must deactivate it before you can set a programme.  
→ Page 34

1. Set the programme you require.

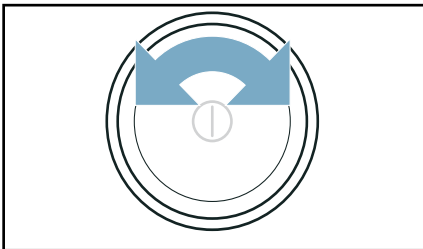

The programme settings will appear on the display.

2. Adjust the programme settings, if required.  
→ "Programme settings" on page 25

**Starting the programme**

Press ▷⏸ (Start/Pause).

**Note:** If you want to prevent the programme from being adjusted inadvertently, activate the childproof lock. → Page 34

**Programme progress**

The programme status will be indicated on the display.

**Note:** When a programme is selected, the expected drying time for the maximum permitted load is displayed. The moisture sensor measures the residual moisture in the laundry as it is being dried. The programme duration and the remaining time indicated on the display are automatically adjusted as the programme progresses, depending on how damp the laundry is (exception: Timed programmes).

**Changing the programme or adding more laundry**

You can remove or add laundry and change or adjust the programme at any time during drying.

1. Open the door or press ▷⏸ (Start/Pause) to pause the programme.  
**Note:** The drum will continue to rotate when the CoolDown process is in progress, even if you have paused the programme. You can stop the CoolDown process at any time by opening the door.
2. Add or remove laundry.

- If required, select a different programme or a different programme setting. → "Overview of programmes" on page 23 → "Programme settings" on page 25  
**Note:** Do not change the programme during the CoolDown process.
- Close the appliance door.
- Press ▷||| (Start/Pause).

**Note:** The programme duration is updated on the display, depending on the load and on the residual moisture in the laundry. The values displayed may change when the programme or load is changed.

## Cancelling the programme

The programme can be cancelled at any time by opening the door or pressing ▷||| (Start/Pause).

### Caution!

#### Risk of fire. Laundry may catch fire.

If you cancel the programme, remove all items of laundry from the dryer and spread them out to allow the heat to dissipate.

## End of programme

End appears in the display.

## Removing laundry and switching off the appliance

- Remove the laundry.

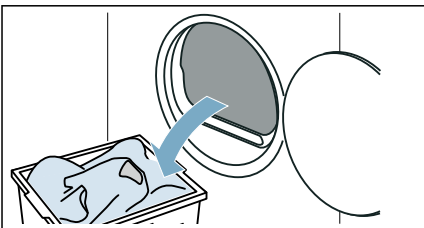

- Press ① to switch off the appliance.

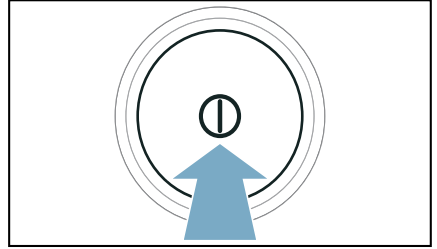

## Emptying the condensation container

Condensation will form in the appliance as it dries the laundry.

If there is no drain hose connected to the appliance, the condensation water from the appliance will run into the condensation container. In this case, you will need to empty the condensation container each time the dryer finishes drying the laundry, and also if it becomes full before drying is complete.

- Pull out the condensation container horizontally.

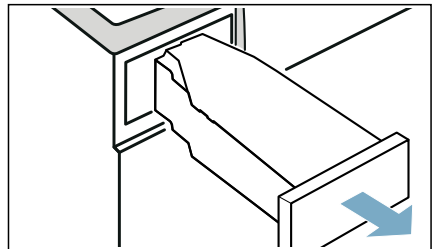

2. Pour out the condensation water.

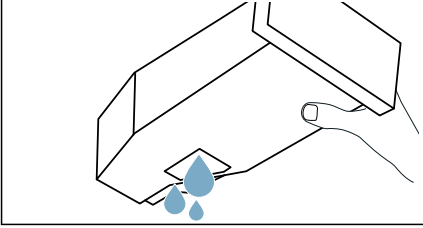

**Caution!**

**Risk of harm to health and material damage**

Condensation water is not suitable for drinking and may be contaminated with fluff. Contaminated condensation water may be harmful to your health and cause material damage. Do not drink the condensation water or reuse it.

3. Push the condensation container back into the appliance until you feel it lock into place.

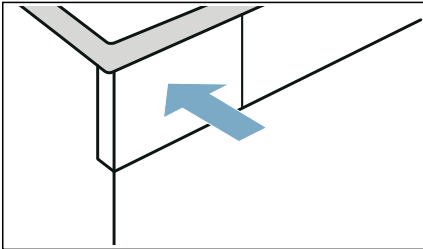

**Note:** The filter in the condensation container filters the condensation water, which is used during the appliance's automatic cleaning cycle. The filter is cleaned by emptying out the condensation water. You should still check the filter regularly for any build-up, and remove this if necessary.

→ "Cleaning the filter in the condensation container" on page 49

## Removing the fluff

**Note:** During drying, fluff and hair from the laundry is trapped by the fluff filter. If the fluff filter is clogged or dirty, this reduces the flow of air, preventing the appliance from achieving optimal drying results. Dirty fluff filters increase the power consumption and increase the required drying time.

**Clean the fluff filter after each drying cycle:**

1. Open the door and remove all fluff from it.
2. Pull out the two-part fluff filter.

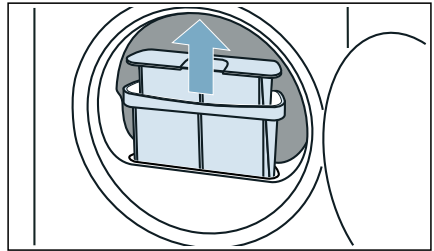

3. Remove the fluff from the fluff filter recess. Ensure that no fluff falls into the open shaft.

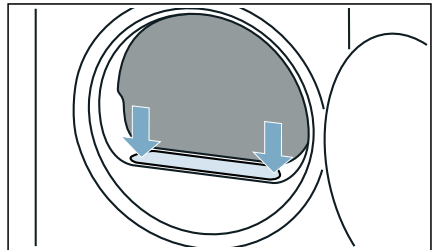

4. Pull the two-part fluff filter apart.

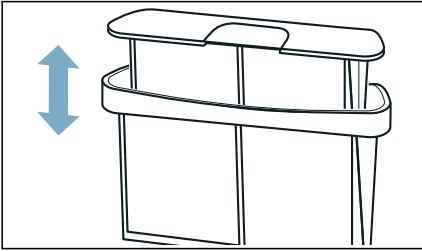

5. Open the two parts of the filter.

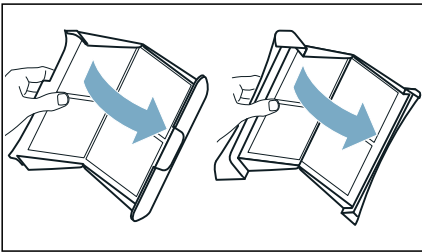

6. Remove all fluff from both parts of the filter.

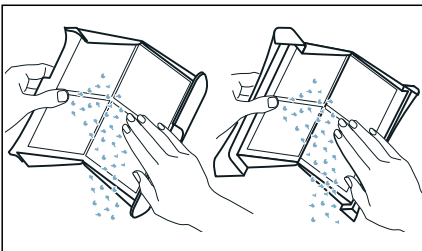

7. Rinse off fluff under warm, running water.

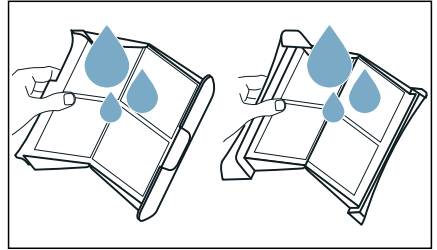

8. Dry the two parts of the fluff filter, snap them shut and reinsert the filter.

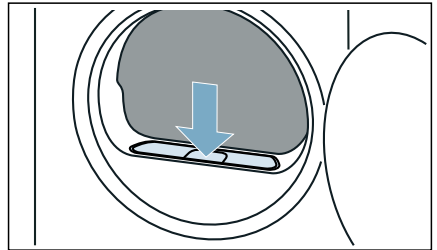

**Caution!**  
**Material damage/damage to the appliance**

If you operate the appliance without a fluff catcher (e.g. fluff filter, fluff depot, depending on appliance specifications), or if the fluff catcher is incomplete or defective, this may result in damage to the appliance.

Do not operate the appliance without a fluff catcher, or with a fluff catcher that is incomplete or defective.



## Appliance settings

You can activate/deactivate appliance settings directly or alter them under ⚙️.

### Childproof lock

Activating the childproof lock prevents the settings from being accidentally changed on the control panel.

#### Activating/deactivating the childproof lock:

- Press and hold 🔒 **3 sec (Child lock)** for 3 seconds.

**Note:** The childproof lock will remain active, even once the appliance has been switched off. If you wish to change settings on the control panel when you turn on the appliance, you will need to deactivate the childproof lock.

### Quiet drying

If you activate 🤫 (Quiet drying), the appliance will operate without any audible operating or notification signals.

#### Activating/deactivating "Quiet drying":

- Press 🤫 (Quiet drying).

The appliance's audible operating and notification signals are now activated/deactivated.

## Altering the appliance settings

You can change the following appliance settings under ⚙️:

- Volume of the audible operating signals
- Display brightness
- Volume of the audible notification signals (e.g. at the end of a programme)

#### Call up ⚙️ as follows:

1. Press ⏻ to switch on the appliance.

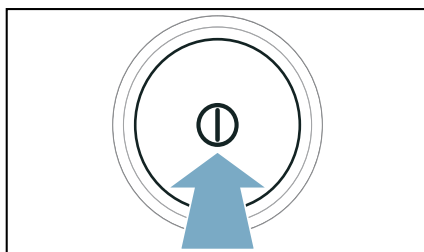

2. Press and hold 🤫 (Quiet drying) for 3 seconds. ⚙️ will be shown on the display.

You can now alter the appliance settings.

## Adjusting the volume of the audible operating signals

1. Set the programme to position 2.

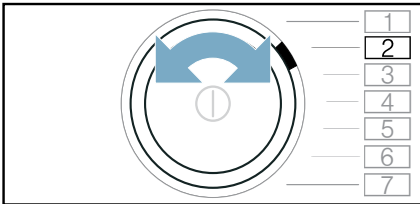

⏪ and the current setting value will appear on the display.

2. Press and hold + until the setting value you require appears on the display.



### Setting values:

- 0 Off
- 1 Low
- 2 Medium
- 3 High
- 4 Very high

3. Alter any additional appliance settings you require or save and exit the appliance settings.

## Adjusting the display brightness

1. Set the programme to position 3.

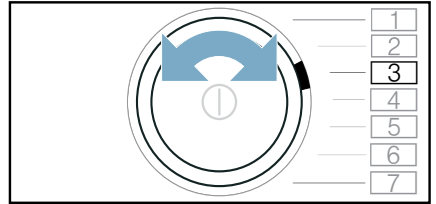

⏪ and the current setting value will appear on the display.

2. Press and hold + until the setting value you require appears on the display.

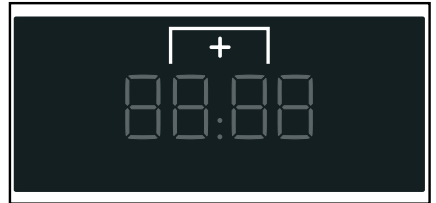

### Setting values:

- 1 Low
- 2 Medium
- 3 High
- 4 Very high

3. Alter any additional appliance settings you require or save and exit the appliance settings.

## Adjusting the volume of the audible notification signals

1. Set the programme to position 1.

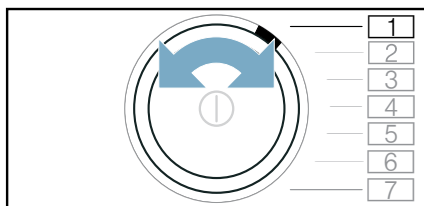

*R* and the current setting value will appear on the display.

2. Press and hold **+** until the setting value you require appears on the display.



### Setting values:

- 0 Off
- 1 Low
- 2 Medium
- 3 High
- 4 Very high

3. Alter any additional appliance settings you require or save and exit the appliance settings.

## Saving and exiting the appliance settings

### Save and exit the appliance settings as follows:

- Press (Quiet drying) or:
- Wait 10 seconds or:
- Press to switch off the appliance.

**Note:** The selected settings will be retained even after the appliance has been switched off.

## Home Connect

This appliance is Wi-Fi-capable and can be remotely controlled using a mobile device.

You can use the Home Connect app to do the following on your appliance from your mobile device:

- Set up programs and launch them.
- Adjust, activate and deactivate program settings.
- Query the status of programs.
- Adjust, activate and deactivate appliance settings.
- Switch off the appliance.

Before you can use the Home Connect functions, you will need to carry out the following steps:

1. Install the Home Connect app on your mobile device.
2. Register in the Home Connect app.
3. Connect your appliance to your home network automatically **or** manually (you only need to do this the first time).
4. Connect your appliance to the Home Connect app.

You can find information about the app on our Home Connect website [www.home-connect.com](http://www.home-connect.com)

Home Connect services are not available in every country. The availability of the Home Connect function depends on the availability of Home Connect services in your country. You can find information on this at: [www.home-connect.com](http://www.home-connect.com)

### Notes

- Please observe the safety precautions in this instruction manual and make sure that these are complied with even when operating the appliance via the Home Connect app while you are away from home. You must also follow the instructions in the Home Connect app.



- You cannot use the Home Connect app to make changes while the controls on the appliance are being operated. However, you can use the Home Connect app to see any adjustments made directly on the appliance itself.

## Calling up the Home Connect menu

In the Home Connect menu, you can create and view network connections, reset network settings, activate/deactivate Wi-Fi and find other Home Connect functions.

1. Switch on the appliance.
2. Press and hold  (Remote Start) for at least 3 seconds.

**FLU** appears in the display. You are now in the Home Connect menu.

**Note:** Briefly press  (Remote Start) to exit the Home Connect menu.

## Connecting to the home network and the Home Connect app

Connect your appliance to the home network **automatically** or **manually** (you only need to do this the first time).

### Notes

- If your home network router has a WPS function, you can connect the appliance to your home network automatically.
- If your home network router does not have a WPS function, you need to connect the appliance to your home network manually.



You must then connect to the Home Connect app.

**Note:** To connect your appliance to the home network, **Wi-Fi** must be activated on the appliance. **Wi-Fi** is deactivated on the appliance by default and is activated automatically when you connect your appliance to your home network.

## Connecting to your home network automatically

### Step 2.1

Ensure that you are in the Home Connect menu. → *Page 37*

1. Press . The appliance now attempts to connect to your home network.  flashes in the display.

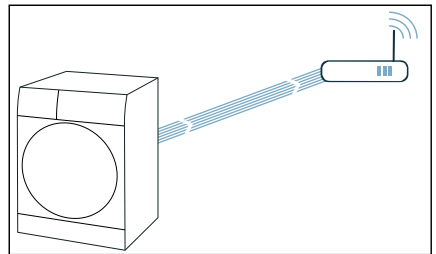

2. Activate the WPS function on your home network router within the next 2 minutes.

If the appliance has connected to your home network successfully, **con** ✓ and  appear in the display and light up continuously.

**Note:** If you are not able to establish a connection, check whether your appliance is within range of your home network. Try connecting automatically again or connect your appliance manually.

## Connecting to your home network manually

### Step 2.2

Ensure that you are in the Home Connect menu. → Page 37

Make sure that you have opened the Home Connect app and are logged in.

1. Set the programme to position 2.

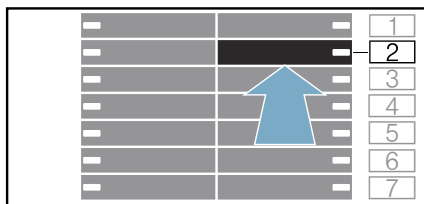

**SFP** (connect manually) appears in the display.

2. Press  $\triangleright$ .

The appliance now sets up its own Wi-Fi network with the name (SSID)

### HomeConnect.

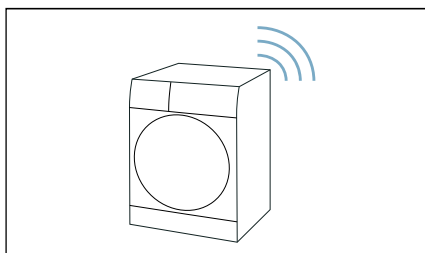

3. Call up the Wi-Fi setting on the mobile device.

4. Connect the mobile device to the **Home Connect** Wi-Fi network and enter the password (key) **HomeConnect**.

Your mobile device now connects to the appliance. The connection process may take up to 60 seconds.

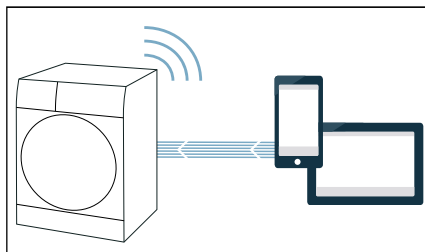

5. Once you have connected successfully, open the Home Connect app on your mobile device and carry out the steps in the app.
6. In the Home Connect app, enter the network name (SSID) and password (key) for **your home network**.
7. Carry out the last steps in the Home Connect app to connect your appliance.

If the appliance has connected to your home network successfully, **CON** ✓ and  $\text{Wi-Fi}$  appear in the display and light up continuously.

**Note:** If you are not able to establish a connection, check whether your appliance is within range of your home network. Try connecting manually again.

## Connecting to the Home Connect app

### Step 3

If your appliance is connected to your home network, you can connect it to the Home Connect app.

Ensure that you are in the Home Connect menu. → *Page 37*

Make sure that you have opened the Home Connect app and are logged in.

1. Set the programme to position 3.

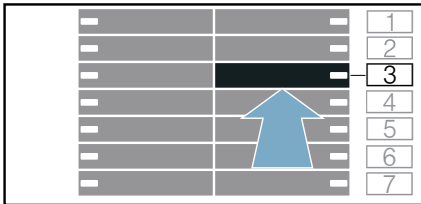

**APP** (connect to app) appears in the display.

2. Press .

The appliance now attempts to connect to the Home Connect app.

3. Once your appliance is displayed in the app, carry out the last steps in the Home Connect app.

**Note:** If you were not able to establish a connection, check whether your mobile end device is within range of your home network or is connected to this. Try connecting to the Home Connect app again.

## Activating/deactivating Wi-Fi

If your appliance is already connected to your home network, you can activate or deactivate **Wi-Fi** on your appliance.

Ensure that you are in the Home Connect menu. → *Page 37*

1. Set the programme to position 4.

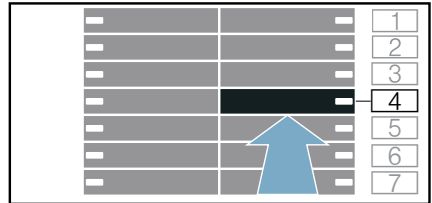

**Wi-Fi** appears in the display.

2. Press **Wi-Fi**.

If **on** appears in the display, Wi-Fi is activated on the appliance. If **off** appears in the display, Wi-Fi is deactivated on the appliance.

### Notes

- If you connect to your home network, Wi-Fi is activated automatically.
- If Wi-Fi is activated, the appliance will not switch itself off automatically.
- If Wi-Fi is switched off on the appliance, it is not possible to use the Home Connect app to start or control the appliance remotely.
- If Wi-Fi is switched off and your appliance was previously connected to your home network, this connection will be re-established automatically when Wi-Fi is switched back on.
- If you activate this function, the energy consumption increases in comparison to the values specified in the consumption value table.  
→ *Page 62*

## Resetting your network settings

You can reset all of the network settings.

Ensure that you are in the Home Connect menu. → Page 37

1. Set the programme to position 5.

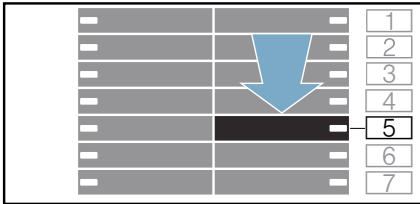

**rES** (reset network settings) appears in the display.

2. Press **▷|||**.
- yES** appears in the display.
3. Press **▷|||**.

**Note:** If you want to operate your appliance via the Home Connect app again, you will need to reconnect it to your home network and to the Home Connect app.

## Updating the software

You can update the Home Connect software on your appliance. As soon as a new software update is available, a note appears in the display: **UPd**

Install the update directly via the **message in the display** or **manually** as follows:

Ensure that you are in the Home Connect menu. → Page 37

1. Set the programme to position 6.

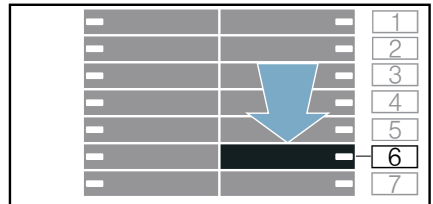

**UPd** (software update) appears in the display. **▷|||** (Start/Pause) flashes if a software update is available.

2. Press **▷|||**.
- yES** appears in the display.
3. Press **▷|||**.

**Note:** The software update may take several minutes. Do not switch the appliance off while updates are being installed.

## Energy management

You can connect your appliance to your smart energy system (Energy manager).

Once you have connected your appliance to the smart energy system (Energy manager) and activated the **FlexStart** function, you will be able to optimise your energy consumption because your appliance will not start up until your home photovoltaic system can provide sufficient energy or the energy tariff is good.

Further information and system requirements for using the Energy manager can be found at: **[www.home-connect.com/energymanagement](http://www.home-connect.com/energymanagement)**

### Notes

- The smart energy system (Energy manager) must use the EEBus initiative communications standard.
- Before you start, read the smart energy system instruction manual to find out how to connect your appliance to the smart energy system (Energy manager).

1. Set the programme to position 7.

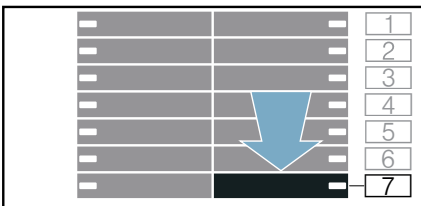

**En** (Energy manager) appears in the display.

2. Press **▶**.  
Your appliance now attempts to connect to the smart energy system (energy manager). If the appliance has connected successfully, **com** appears in the display.
3. Activate Flexstart if you want the smart energy system (Energy manager) to start up your appliance.

## FlexStart

Activate the **FlexStart** function to allow your smart energy system (Energy manager) to start your appliance once your home photovoltaic system is able to provide sufficient energy or the energy tariff is good.

**Note:** Your smart energy system (Energy manager) cannot start your appliance until it is connected to the appliance.

Activate **FlexStart** as follows:

1. Select the programme you require.
2. Use the **+** and **-** selection buttons for the "Finished in" time to set the required time.
3. Press **▶** (Start/Pause).
4. Press **□** (Remote Start).  
**En** appears in the display.

The **FlexStart** function has now been activated and the appliance will wait to be remotely started by the smart energy system (Energy manager).

If the time changes on the display to **→ 3.0h**, for example, the smart energy system (Energy manager) has established a time at which your appliance can start. The programme will end after the specified time.



### Notes

- If the smart energy system (Energy manager) does not start your appliance, the programme will still be started before the set time period ends.  
The programme will end when the time period ends.
- For safety reasons, **□** and in turn the **FlexStart** function will be deactivated in the following circumstances:
  - Press **▶**.
  - Open the door.
  - Programme end.
  - Press **⓪** to switch off the appliance.

- Power failure.  
If the **FlexStart** function is deactivated, the  (Ready in) will remain active.

### Adding more laundry or removing laundry:

**Note:** If the **FlexStart** function has already been activated but the programme has not yet started, you will still be able to load more laundry or remove some from the drum.

1. Press  (Start/Pause).
2. Open the door.
3. Add or remove laundry.
4. Close the appliance door.
5. Press  (Start/Pause).
6. Press  (Remote Start).

The **FlexStart** function has now been activated and the appliance will wait to be remotely started by the smart energy system (Energy manager).

### Information on data protection

When your appliance is connected for the first time to a Wi-Fi network, which is connected to the Internet, your appliance transmits the following categories of data to the Home Connect server (initial registration):

- Unique appliance identification (consisting of appliance codes as well as the MAC address of the installed Wi-Fi communication module).
- Security certificate of the Wi-Fi communication module (to ensure a secure data connection).
- The current software and hardware version of your household appliance.

- Status of any previous resetting to factory settings.

This initial registration prepares the Home Connect functions for use and is only required when you want to use these Home Connect functions for the first time.

**Note:** Ensure that the Home Connect functions can be used only in conjunction with the Home Connect app. Information on data protection can be accessed in the Home Connect app.

### Declaration of Conformity

BSH Hausgeräte GmbH hereby declares that the appliance with Home Connect functionality meets the basic requirements and other relevant provisions of the Directive 2014/53/EU.

A detailed RED Declaration of Conformity can be found online at [www.siemens-home.bsh-group.com](http://www.siemens-home.bsh-group.com) among the additional documents on the product page for your appliance.



2.4 GHz band: max. 100 mW

## Drying with the basket for woollens

### The basket for woollens

**Note:** The basket for woollens is supplied with your appliance\* or it can be purchased as an accessory from our after-sales service.

#### Caution!

#### Risk of material damage to the appliance and laundry

Operating the dryer when the basket for woollens is damaged may damage the appliance and the laundry.

Never operate the appliance if the basket for woollens is damaged.

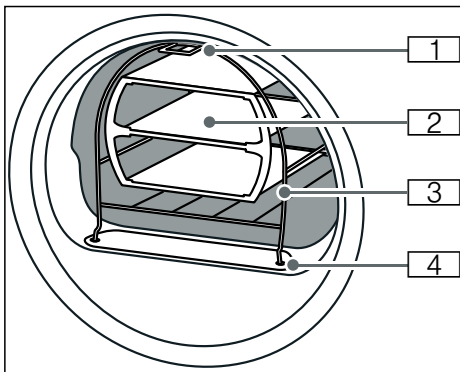

- 1 Foot for securing to the hook in the upper section of the front panel on the appliance
- 2 Insert for the basket for woollens
- 3 Basket for woollens
- 4 Feet for securing in the fluff filter

### Securing the basket for woollens

1. Insert the feet of the basket for woollens into the holes in the fluff filter.

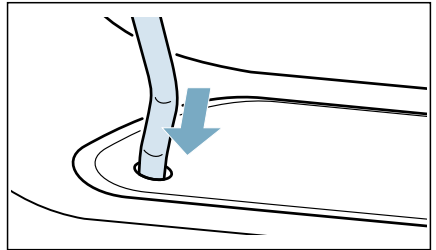

2. Rest the basket for woollens on the upper hooks starting at the front.

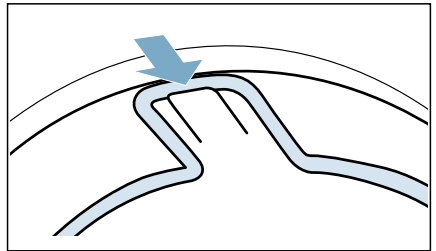

The basket for woollens should now be securely fixed to the front panel.

### Application examples

- **Laundry**  
Laundry must be spun.  
Place laundry loosely in the insert; do not squash.  
– Trousers or skirt

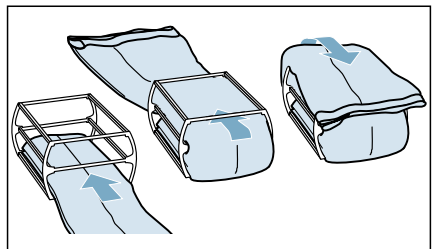

\* Depending on the model

en Drying with the basket for woollens

– Pullover

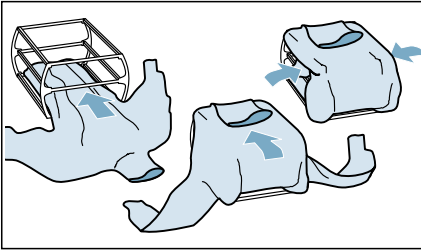

■ Sports shoes

Place sports shoes in the basket for woollens **without** the insert. Pull the tongue quite far out of the shoes. Remove insoles and heel cushions. Roll up a towel and place it under the sports shoes to create an inclined surface. Place the shoes so that the heels are on the towel.

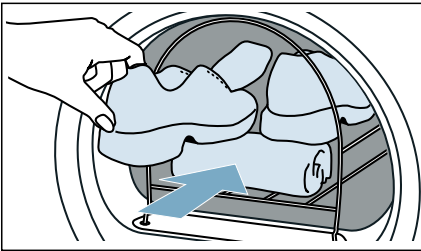

■ Soft toys

Dry soft toys in the basket for woollens without the insert. Only place as many soft toys in the basket for woollens as is possible without any falling out.

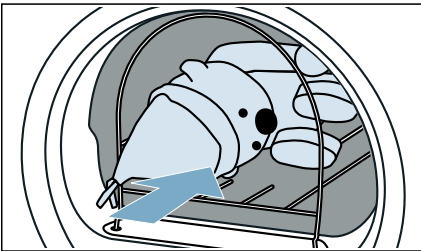

## Putting the insert in place and starting a programme

1. Place the insert with laundry, sports shoes or soft toys in the basket for woollens.

**Caution!**

**Risk of material damage to the laundry**

Place the laundry in the insert of the basket for woollens so that they do not come into contact with the drum.

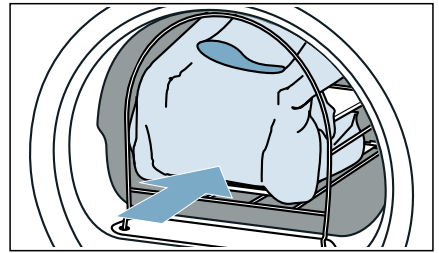

2. Select the programme for the basket for woollens or a timed programme.  
→ "Overview of programmes" on page 23
3. Set the drying time.  
The table below lists examples for the loads with a suggested drying time.

Thin woollen pullover	Approx. 1 h 20
Thick woollen pullover	Approx. 1 h 30 - 3 h 00
Skirt	Approx. 1 h 00 - 1 h 30
Trousers	Approx. 1 h 00 - 1 h 30
Gloves	Approx. 30 min
Sports shoes	Approx. 1 h 30/ max. 2 h 00 with airing

**Note:** For items made from thicker or multi-layered fabrics, you may need to extend the drying time to achieve the required dryness level.

4. Start the programme.
5. Once the programme has ended, remove the load and switch off the appliance.





## Draining the condensation water

Condensation will form in the appliance as it dries the laundry.

You must ensure that the drain hose is connected when you operate the appliance.

If there is no drain hose connected to the appliance, the condensation water from the appliance will run into the condensation container. In this case, you will need to empty the condensation container each time the dryer finishes drying the laundry, and also if it becomes full before drying is complete.

### Connect the drain hose as follows:

1. Remove any accessories from the drum.

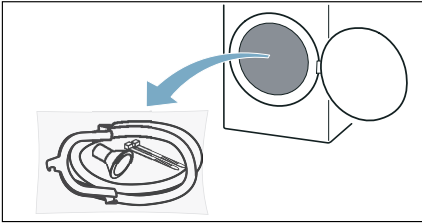

2. Remove all items from the bag.

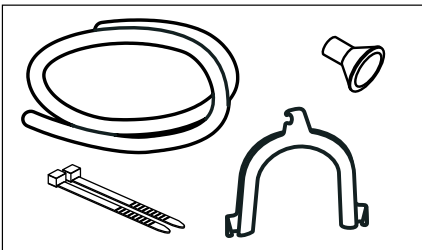

3. Detach the condensation hose from the socket.

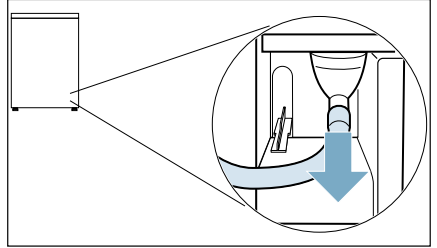

**Note:** The appliance comes delivered with the condensation hose already fitted to the socket.

4. Place the condensation hose in the "parked" position.

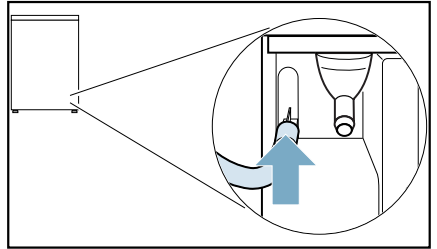

5. Take the drain hose from the accessories and attach it to the free socket, pushing it up to the stop.

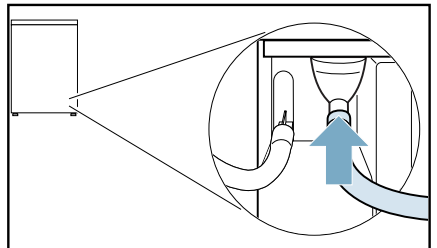

**en** Draining the condensation water

6. Secure the other side of the drain hose using the remaining accessories, depending on the connection situation.

**Washbasin:**

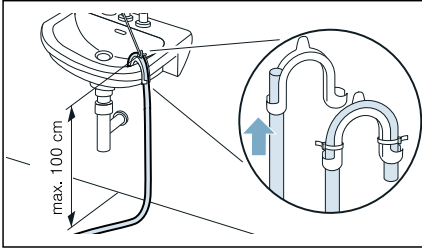

**Siphon:**

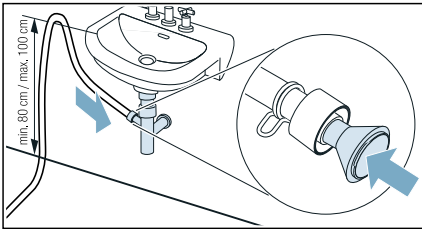

The connection point must be secured using a hose clamp (12-22 mm clamping range, available from specialist retailers). When connecting to a siphon, make sure that the drain hose is routed at a height of at least 80 cm, but no more than 100 cm.

**Tip: Y-connection adapter for the water outlet**

If you have a washing machine connected to the same outlet, you can secure the water outlet hose and the drain hose (from the connection kit) to the adapter on the drain. Order number: **15000490**

**Floor drain:**

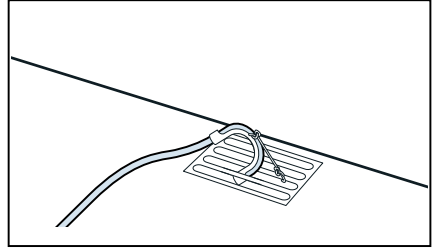

**Caution!**

**Risk of material damage due to leaks or draining water.**

Secure the drain hose to prevent it from slipping out. Do not kink or bend the drain hose. The height difference between the surface on which the appliance is installed and the drain hose must be no more than 100 cm.

**Caution!**

**Risk of accumulated water being drawn back into the appliance and causing material damage.**

Check that the water drains away quickly. The drain must not be sealed or blocked.

7. Pull out the condensation container horizontally and empty it.

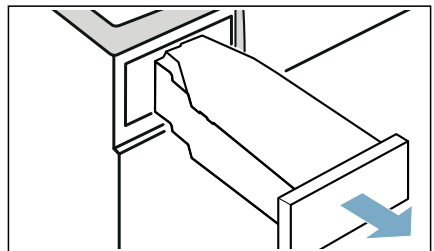

8. Turn the condensation container 180° onto its underside and remove the stopper that is fitted.

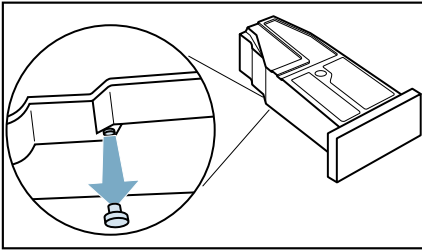

9. Turn the condensation container 180° again and insert the stopper into the recess in the top of the condensation container.

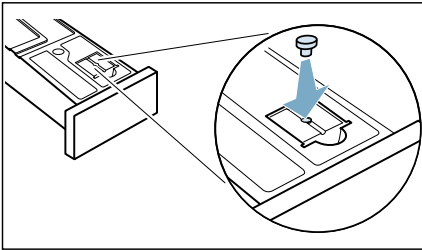

10. Slide in the condensation container until it clicks into place.

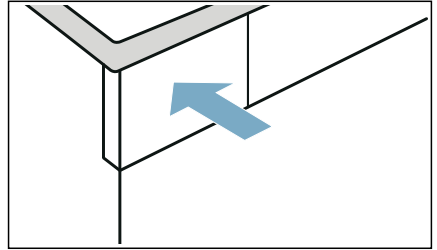

The condensation water is now discharged via the drain hose into the waste-water system or into a washbasin.

**Note:** If you want to drain the condensation water back into the condensation container, reverse these steps.

**Caution!**  
**Risk of material damage/damage to the appliance**

If you are draining condensation water into the condensation container, liquid may leak out of the socket and cause material damage. Before operating the appliance, make sure that the condensation hose is secured to the socket.



## Cleaning and maintenance

### Cleaning the appliance



#### Warning

##### Risk of death!

The appliance is powered by electricity. There is a risk of electric shock if you come into contact with live components. Therefore please note:

- Switch off the appliance. Disconnect the appliance from the power supply (pull out the plug).
- Never take hold of the mains plug with wet hands.
- When removing the mains plug from the socket, always take hold of the plug itself and never the mains cable, otherwise this may damage the mains cable.
- Do not make any technical modifications to the appliance or its features.
- Repairs and any other work on the appliance must only be conducted by our customer service or by an electrician. The same applies for replacing the mains cable (when necessary).
- Spare mains cables can be ordered from our customer service.



#### Warning

##### Risk of poisoning!

Poisonous fumes may be given off by cleaning agents that contain solvents, e.g. cleaning solvent. Do not use cleaning agents that contain solvents.



#### Warning

##### Risk of electric shock/material damage/damage to the appliance!

If moisture penetrates the appliance, this may cause it to short circuit. Do not use a pressure washer, steam cleaner, hose or spray gun to clean your appliance.

#### Caution!

##### Material damage/damage to the appliance

Cleaning agents and agents for pretreating laundry (e.g. stain removers, prewash sprays, etc.) may cause damage if they come into contact with the surfaces of the appliance. Therefore please note:

- Do not allow these agents to come into contact with the surfaces of the appliance.
- Clean the appliance with nothing but water and a soft, damp cloth.
- Remove any detergent, spray or other residues immediately.

### Cleaning the moisture sensor

**Note:** The moisture sensor measures the amount of moisture in the laundry. After long periods of usage, the moisture sensor may become covered by a fine layer of limescale or detergent and care product residue. These deposits must be removed regularly, otherwise the drying results may not be optimal.

1. Open the door.

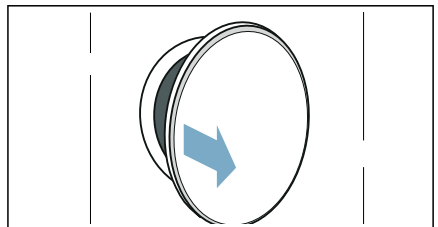

2. Clean the moisture sensor with a rough sponge.

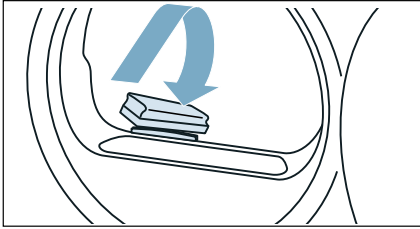

**Caution!**

**Risk of damaging the moisture sensor.**

The moisture sensor is made from stainless steel. Do not clean the sensor with abrasive cleaning products or wire wool.

**Cleaning the filter in the condensation container**

**Note:** The filter in the condensation container cleans the condensation water, which is used during the appliance's automatic cleaning cycle.

1. Pull out the condensation container horizontally.

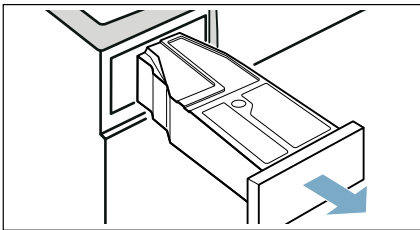

2. Pour out the condensation water.

3. Remove the filter.

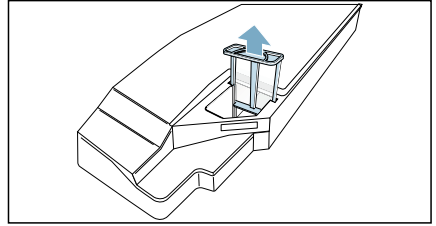

4. Clean the filter under warm, running water or in the dishwasher.

**Note:** You can use a soft brush to clean off more stubborn dirt.

5. Push the filter in until you feel it lock into place.

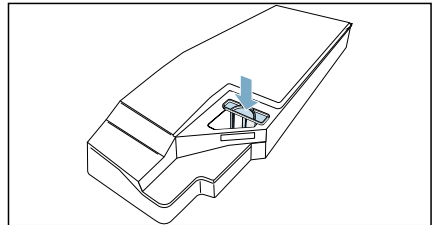

**Caution!**

**If the filter is not inserted, fluff can find its way inside the appliance and damage it.**

Only operate the appliance with the filter inserted.

6. Push the condensation container in until you feel it lock into place.

## Cleaning the base unit

You can clean the appliance's base unit if it has fluff in it, for example.

**Note:** Allow the appliance to cool down for approximately 30 minutes after use before commencing cleaning.

### Clean the base unit as follows:

1. To open the maintenance flap, take hold of it at the top at both sides and pull it down.

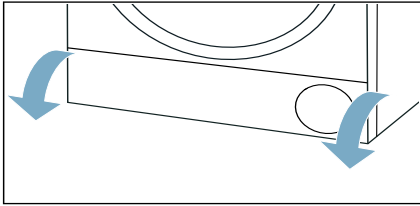

2. Clean the maintenance flap with a soft, damp cloth.

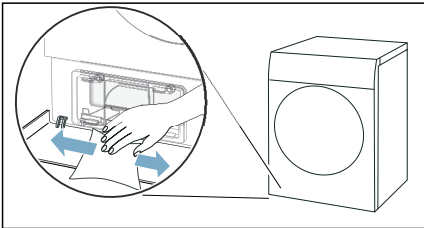

3. Unlock the levers on the heat exchanger cover.

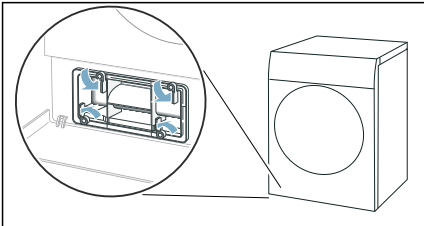

4. Pull the heat exchanger cover out by its grip.

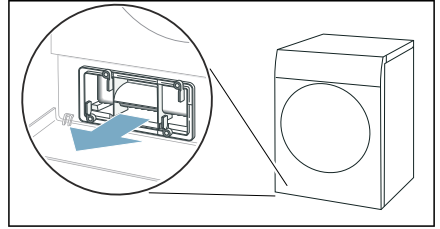

5. Use a soft brush to clean the heat exchanger cover.

**Note:** Make sure that no dirt or debris is left on the seal.

6. Pull the insert out horizontally.

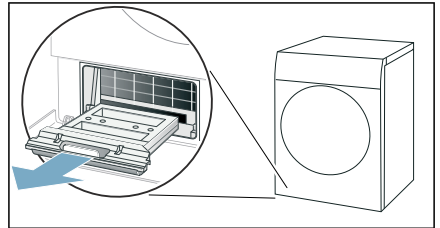

7. Rinse the insert under running water and dry it off.

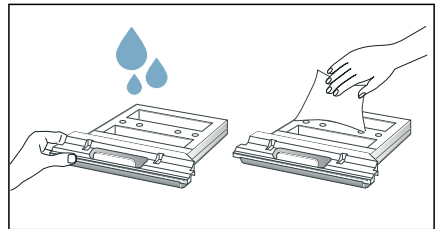

8. Clean the opening in the appliance with a soft, damp cloth.

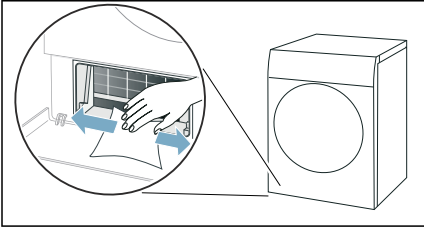

**Notes**

- Be careful not to damage the heat exchanger, as it is exposed.
- Thanks to the appliance's self-cleaning function, you do not need to clean the heat exchanger.

9. Slide the insert in horizontally as far as it will go.

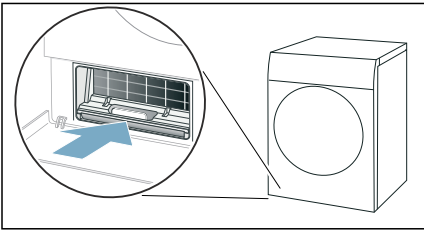

10. Slide the heat exchanger cover in by its grip.

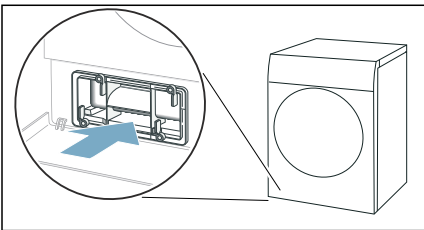

**Note:** You can only slide the heat exchanger cover in if the insert is in the appliance.

11. Lock the levers on the heat exchanger cover.

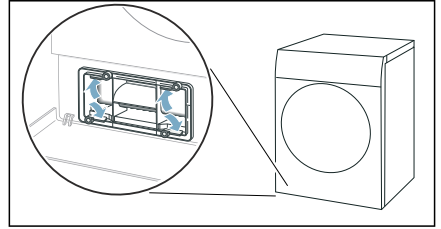

12. Close the maintenance flap.

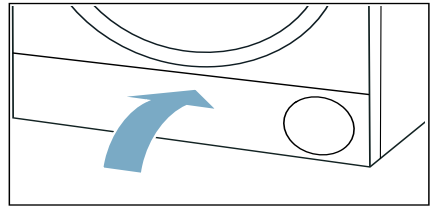

You have now finished cleaning the appliance's base unit.



## Appliance care

The appliance offers additional cleaning programmes that you can run for the maintenance of the appliance:

- You can use the basic appliance care to remove any light dirt deposits in the appliance.
- You can use the intensive appliance care to remove any stubborn dirt deposits in the appliance and any odours after an extended period.

Before running the appliance care programme, the appliance must be suitably prepared.



### Warning

#### Risk of scalding/material damage/ damage to the appliance!

Boiling or hot water can cause severe scalding as well as material damage and damage to the appliance if it is spilled or leaks out.

Do not use boiling water for this appliance or its components or accessories. Do not allow hot water or steam to come into contact with your skin.



### Warning

#### Risk of poisoning/material damage!

Condensation water is not suitable for drinking and may be contaminated with lint. Contaminated condensation water may be hazardous to health and may cause material damage. Do not drink or reuse.

## Preparing the appliance for appliance care

### Preparing the appliance for appliance care

The appliance must be prepared **before** you can run a basic or intensive appliance care programme.

#### Prepare the appliance for appliance care as follows:

1. Remove the laundry.

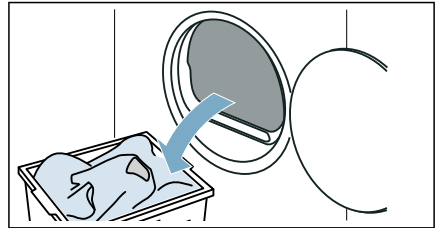

2. Clean the fluff filter. → [Page 32](#)
3. Close the appliance door.
4. Pull out the condensation container horizontally and empty it.

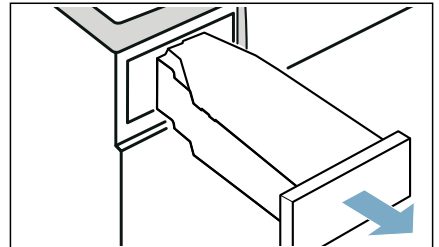



5. Press ① to switch on the appliance.

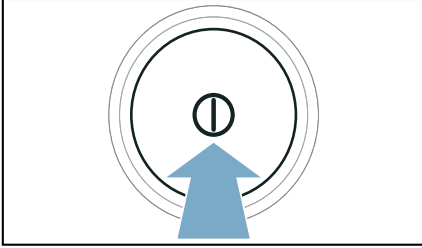

The appliance is now ready to run the appliance care programme.

### Preparing the condensation container for appliance care

If you are draining the condensation water from the appliance using the drain hose, the condensation container must be prepared **before** the basic or intensive appliance care programme can be run.

#### Prepare the condensation container for appliance care as follows:

1. Remove the filter from the recess on the condensation container.

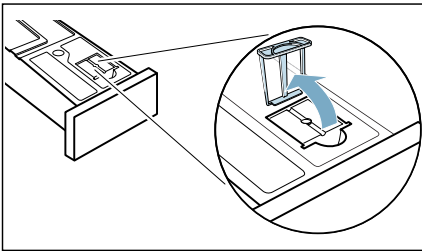

2. Remove the stopper inserted in the recess on the condensation container.

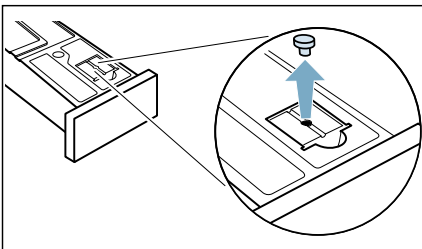

3. Turn the condensation container 180° onto its underside and insert the stopper.

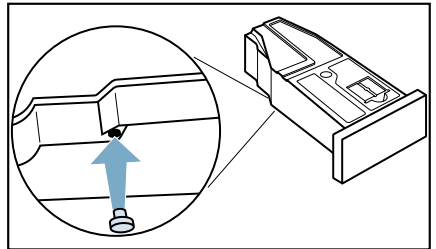

4. Push the filter in until you feel it lock in place.

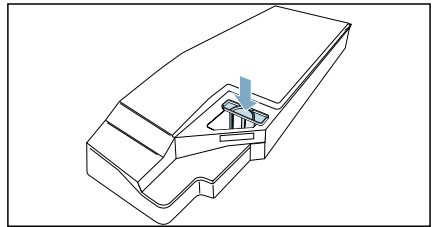

#### Caution!

**If the filter is not inserted, fluff can find its way inside the appliance and damage it.**

Only operate the appliance with the filter inserted.

The condensation container is now ready for the appliance care programme.

**Note:** If you are draining the condensation water from the appliance using the drain hose, reverse these steps **after** running the basic or intensive appliance care programme.

## Running the basic appliance care programme

To remove any dirt deposits in the appliance, you can run the basic appliance care programme.

**Note:** After a certain period, your appliance will automatically recommend that you run the basic appliance care programme. **CPi** will then appear on the display for 5 seconds before the programme starts, and again once the programme ends. This message will appear repeatedly until you have run the basic appliance care programme through to the end.

### Run the appliance care programme as follows:

1. Prepare the appliance for appliance care. → Page 52
2. Set the programme to position 1.

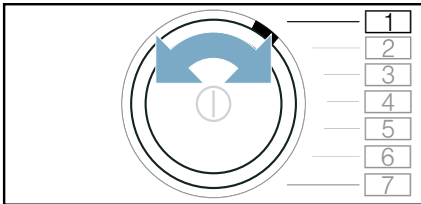

3. Press and hold **☰** (Iron Dry). At the same time:
4. Set the programme to position 4.

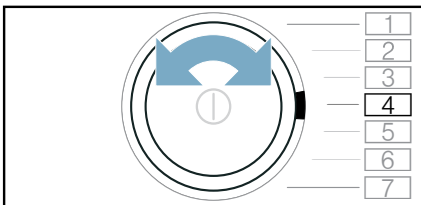

**CPi** and the programme duration will now alternate on the display.

5. Pour approx. 1 ½ litre of warm tap water into the condensation container.

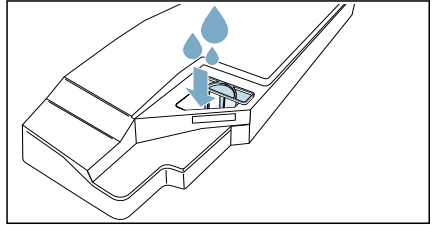

**Note:** Hold the full condensation container horizontally at all times so that no liquid spills out.

6. Slide in the condensation container until it clicks into place.

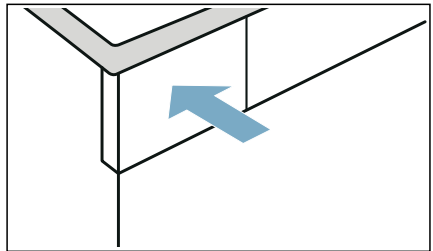

7. Press **▶||** (Start/Pause). The appliance care programme will start and an audible signal will sound.

**End** will appear on the display once the appliance care programme has ended and an audible signal will sound.

8. Pull out the condensation container horizontally and empty it.

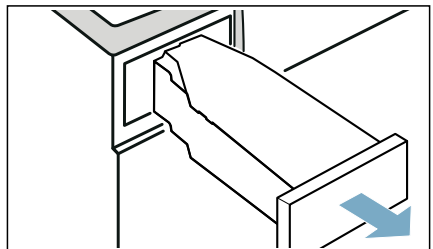

9. Slide in the condensation container until it clicks into place.

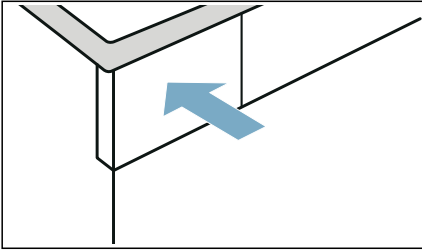

10. Press  to switch off the appliance.

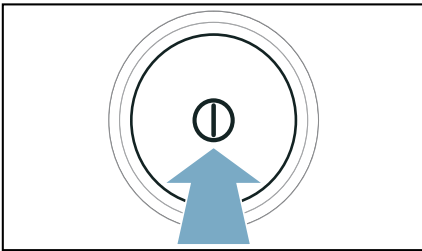

You have now completed the appliance care programme.

## Running the intensive appliance care programme

You can run the intensive appliance care programme to remove any stubborn dirt deposits in the appliance and odours after a downtime of more than one month.

### Notes

- The intensive appliance care programme runs for approximately 4 hours. The programme may take longer if you do not carry out the necessary steps in good time while the programme is running.
- Once it has started, the intensive appliance care programme should not be cancelled.

- When you run the intensive appliance care programme, you will need to use the original appliance care product. This can be ordered from our after-sales service using spare part number **00311829**. Contact information for all countries can be found in the enclosed after-sales service directory.

### Warning

#### Risk of injury/material damage/damage to the appliance!

The use of spare parts and accessories supplied by other brands is dangerous and may result in injury, material damage or damage to the appliance. For safety reasons, use genuine spare parts and accessories only.

### Caution!

#### Material damage/damage to the appliance

If you pour the wrong quantity of detergent or cleaning agent into the appliance, this may result in material damage or damage to the appliance. Use detergents/care products/cleaning agents and softeners in accordance with the manufacturers' instructions.

### Run the appliance care programme as follows:

1. Prepare the appliance for appliance care. → *Page 52*
2. Set the programme to position 1.

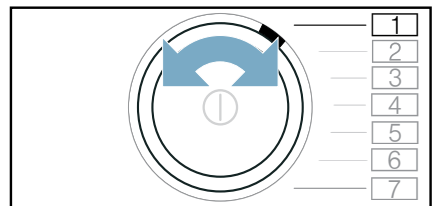

3. Press and hold  (Iron Dry). At the same time:

4. Set the programme to position 4.

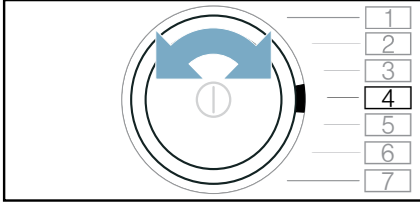

**CP1** and the programme duration will now alternate on the display.

5. Press **+**.



**CP2** and the programme duration will now alternate on the display.

6. Pull out the condensation container horizontally and empty it.

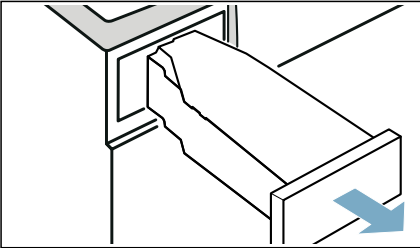

7. Pour a bottle of the original appliance care product and approx. 1 ½ litre of warm tap water into the condensation container.

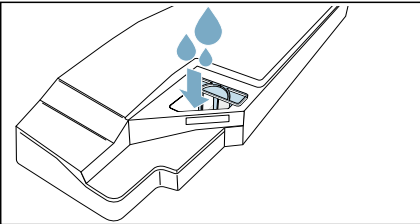

**Note:** . Hold the full condensation container horizontally at all times so that no liquid spills out.

8. Slide in the condensation container until it clicks into place.

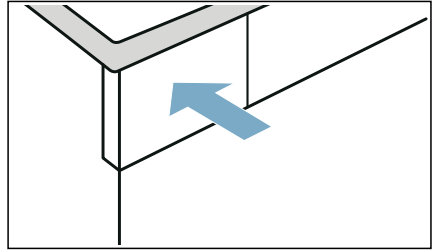

9. Press **▷|||** (Start/Pause). The appliance care programme will start and an audible signal will sound. After approx. three hours, the appliance pauses the appliance care programme and the remaining programme duration flashes in the display.

10. Pull out the condensation container horizontally and empty it.

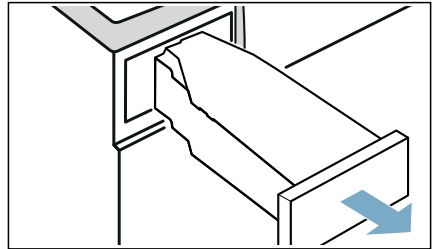

11. Pour approx. 1 ½ litre of warm tap water into the condensation container.

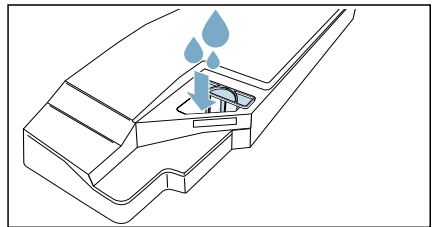

**Note:** Hold the full condensation container horizontally at all times so that no liquid spills out.

- 12.** Carefully swing the condensation container round horizontally and empty it to dispose of any remaining original appliance care product.

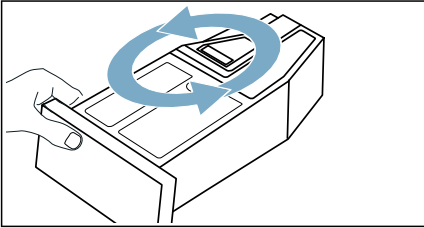

- 13.** Pour approx. another 1 ½ litre of warm tap water into the condensation container.  
**14.** Slide in the condensation container until it clicks into place.

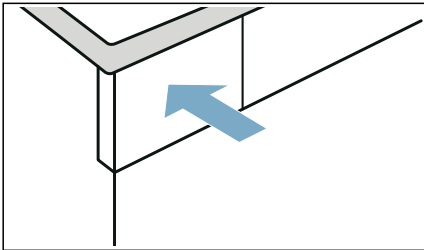

- 15.** Press ▷||| (Start/Pause).  
 The appliance care programme will then be resumed.

*End* will appear on the display once the appliance care programme has ended and an audible signal will sound.

- 16.** Empty the condensation container again.  
**17.** Slide in the condensation container until it clicks into place.

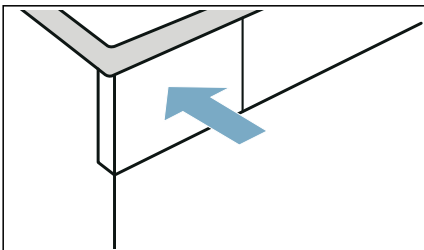



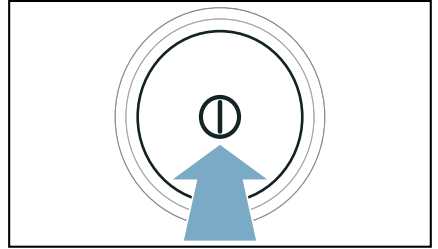

- 18.** Press ① to switch off the appliance.



You have now completed the appliance care programme.

## Help with the appliance

Faults	Cause/Remedy
Appliance does not start	Check the mains plug and the fuses.
Creasing.	<ul style="list-style-type: none"> <li>■ Load exceeded or incorrect programme selected for a type of fabric. All the required information can be found in the programme table. → Page 23</li> <li>■ Remove laundry from the drum as soon as the drying programme has finished. Creasing occurs when clothing is left in the drum.</li> </ul>
Water is leaking out.	<ul style="list-style-type: none"> <li>■ The appliance may be positioned at an angle. Level the appliance.</li> <li>■ In the base unit, make sure that:                             <ul style="list-style-type: none"> <li>- The heat exchanger cover is properly locked.</li> <li>- There is no dirt or debris on the heat exchanger cover's seal.</li> </ul>                             → Page 50                         </li> <li>■ If the optional drain hose* is installed, make sure that the drain hose is correctly connected. → Page 45</li> </ul>
The programme does not start	<p>Make sure that:</p> <ul style="list-style-type: none"> <li>■ The door is closed</li> <li>■ The  3 sec (Child lock) has been deactivated</li> <li>■ You have pressed  (Start/Pause)</li> </ul> <p><b>Note:</b> If the programme has been delayed by setting  (Ready in), the programme starts at a later point.</p> <p>If <b>SHOP</b> is shown in the display for five seconds after you switch the appliance on or off, this means that the appliance is in shop mode. Switch shop mode off as follows:</p> <ol style="list-style-type: none"> <li>1. Switch the appliance off and on again.</li> <li>2. Wait until the <b>SHOP</b> message goes out on the display.</li> <li>3. Press and hold  (Start/Pause) for at least five seconds. <b>OFF</b> appears in the display and the appliance switches itself off automatically. Shop mode is now deactivated and you can use the appliance as normal.</li> </ol>
Programme duration displayed changes as drying progresses.	Not a fault. The moisture sensor measures the residual moisture in the laundry and adjusts the programme duration (with the exception of timed programmes).

<p>Laundry is not dried properly or is still too damp.</p>	<ul style="list-style-type: none"> <li>■ After the programme has ended, warm laundry feels damper than it actually is. Spread out the laundry and let it cool down.</li> <li>■ Adjust the drying time or increase the degree of dryness. This will extend the drying time but the temperature will remain the same.</li> <li>■ Select a timed programme to add extra drying time for laundry that is still damp.</li> <li>■ Select timed program for a small load and individual items of laundry.</li> <li>■ Do not exceed the maximum load for a programme. → <i>Page 23</i></li> <li>■ Clean the moisture sensor in the drum. The sensor may become covered in a fine layer of limescale or detergent and care product residue, which then impairs its performance. → <i>Page 48</i></li> <li>■ Drying has been interrupted as a result of a power cut, because the condensation container is full or because the maximum drying time has been exceeded.</li> </ul> <p><b>Note:</b> See also the laundry tips. → <i>Page 28</i></p>
<p>Drying is taking too long.</p>	<ul style="list-style-type: none"> <li>■ The appliance may have fluff in it. This will increase the required drying time. Remove the fluff. → <i>Page 32</i></li> <li>■ The heat exchanger may have fluff in it. Run the basic appliance care programme. → <i>Page 54</i></li> <li>■ If the air inlet on the appliance is blocked or not fully open, this may increase the drying time. Make sure that the air inlet remains unobstructed.</li> <li>■ If the ambient temperature is lower than 15 °C or higher than 30 °C, this may increase the drying time.</li> <li>■ Inadequate air circulation in the room may increase the drying time. Make sure the room is adequately ventilated.</li> </ul>
<p>Unpleasant odour in the appliance</p>	<p>Run the intensive appliance care programme. → <i>Page 55</i></p>
<p>I am unable to connect to my home network.</p>	<ul style="list-style-type: none"> <li>■ Wi-Fi is switched off. To connect to your home network, switch on Wi-Fi.  must appear on the display.</li> <li>■ Wi-Fi is switched on but a connection to your home network cannot be established. Check whether your home network is available or try to connect to your home network again.</li> </ul>
<p>Home Connect is not working.</p>	<ul style="list-style-type: none"> <li>■ You can find solutions to problems with Home Connect at <a href="http://www.home-connect.com">www.home-connect.com</a>.</li> <li>■ The availability of the Home Connect functionality depends on the availability of the Home Connect Services (e.g. provision of the app) in your country. Home Connect Services are not available in every country – for further information please check: <a href="http://www.home-connect.com">www.home-connect.com</a>.</li> </ul>
<p>Humidity in the room is increasing.</p>	<p>Make sure the room is sufficiently ventilated.</p>
<p>Unusual noises when drying.</p>	<p>When drying is in progress, the pump and compressor generate noise when operating normally. This does not indicate that the appliance is malfunctioning.</p>

## en Help with the appliance

The appliance feels cold despite drying.	Not a fault. The appliance can dry effectively at low temperatures using a heat pump.
Drying programme is stopped.	If the drying programme is stopped due to a power failure, restart the programme or remove the laundry and spread it out.
Residual water in the condensation container despite the appliance being connected to the drain hose*.	If the optional drain hose is installed, residual water remains in the condensation container due to the appliance's self-cleaning function.
* Depending on how the appliance is equipped or the available accessory	

**Note:** If you cannot rectify the fault yourself by turning the appliance off and then on again, please contact our after-sales service.—→ *Page 64*





## Transporting the appliance

### **Warning**

#### **Risk of injury/material damage/ damage to the appliance!**

If you take hold of any of the appliance's protruding parts (e.g. the appliance door) in order to lift or move it, these parts may break off and cause injury. Do not take hold of any of the appliance's protruding parts in order to move the appliance.

### **Warning**

#### **Risk of injury!**

- The appliance is very heavy. Lifting it may result in injury. Do not lift the appliance on your own.
- The appliance has sharp edges on which you could cut your hands. Do not take hold of the appliance by its sharp edges. Wear protective gloves to lift it.

#### **Prepare the appliance for transportation as follows:**

1. Pull out the condensation container horizontally and empty it.

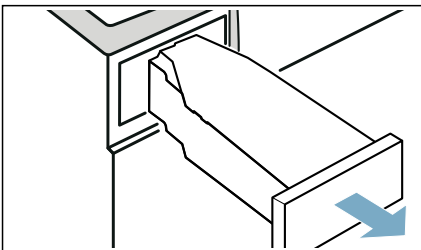

2. Push the condensation container back into the appliance until you feel it lock into place.

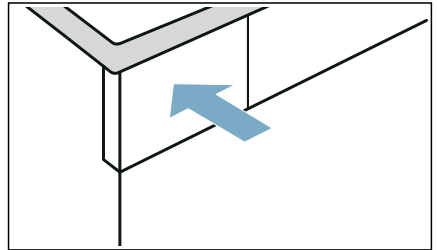

3. Switch on the appliance.
4. Set any programme.
5. Press **▷||** (Start/Pause).
6. Wait for 5 minutes. The condensation water will be drained.
7. Empty the condensation container again.
8. If installed, remove the drain hose from the washbasin, siphon or floor drain. → *Page 45*

#### **Caution!**

Secure the drain hose to the appliance to prevent it from slipping out. Do not kink the drain hose.

9. Switch off the appliance.
10. Disconnect the appliance's mains plug from the power supply.

The appliance is now ready to be transported.

#### **Caution!**





#### **Risk of material damage/damage to the appliance**

Despite draining, there will always be some residual water in the appliance. Any residual water may leak out and cause material damage.

The appliance should therefore be transported upright.

## Consumption values

### Consumption values table



Programme	Spin speed used for spinning the laundry (in rpm)	Duration** (in min)		Energy consumption** (in kWh)	
		9 kg	4.5 kg	9 kg	4.5 kg
<b>algodón/algodão (Cottons)</b> 		<b>9 kg</b>	<b>4.5 kg</b>	<b>9 kg</b>	<b>4.5 kg</b>
Cupboard Dry  *	1400	143	94	1.68	1.00
	1000	162	104	1.97	1.16
	800	181	115	2.26	1.32
Iron Dry  *	1400	105	67	1.18	0.70
	1000	124	77	1.47	0.86
	800	143	88	1.76	1.02
<b>sintéticos (Synthetic)</b>		<b>3.5 kg</b>		<b>3.5 kg</b>	
Cupboard Dry  *	800	55		0.51	
	600	65		0.64	

\* Programme setting in accordance with the applicable EN61121 standard when using the external drain hose.

\*\* The values may differ from those specified, depending on the type of fabric, composition of laundry to be dried, residual moisture in the laundry, the degree of dryness that has been set, the amount of laundry being loaded, the environmental conditions, and any additional functions that have been activated.

### Most efficient programme for cotton laundry

The "standard cottons programme" below (denoted by the  symbol) is suitable for drying cotton laundry with a normal dampness level, and is the most efficient programme for drying damp cotton laundry in terms of combined energy consumption.

Standard programmes for cottons in accordance with current EU regulation 932/2012			
Programme + dryness level	Load (in kg)	Energy consumption (in kWh)	Programme duration (in min)
 Cottons + Cupboard dry 	9/4.5	1.97/1.16	162/104

Programme setting for testing and energy labelling in accordance with Directive 2010/30/EU.



## Technical data

### Dimensions:

850 x 600 x 640 mm  
(height x width x depth)

### Weight:

56 kg (depending on the model)

### Mains connection:

Mains voltage 220 - 240 V, 50 Hz

Nominal current 10 A

Nominal power 800 W

### Maximum load:

9 kg

### Power consumption when switched off:

0.10 W

### Power consumption when left on:

0.10 W

### Drum interior light\*

### Ambient temperature:

5 - 35 °C

### Power consumption when networked (Wi-Fi) in standby mode/duration:

1.5 W / 20 mins

This product contains light sources from energy efficiency class F. These light sources are available as a spare part and must only be replaced by trained specialist staff.



## Disposal



Dispose of packaging and the appliance in an environmentally responsible manner.

This appliance is labelled in accordance with the European Directive 2012/19/EU, which governs waste electrical and electronic equipment (WEEE). The directive provides a framework for the collection and recycling of old appliances, which is valid across the EU.

### Caution!

### Risk of fire/risk of poisoning/risk of material damage and damage to the appliance

The appliance contains R290, a refrigerant that is environmentally friendly but flammable. If it is not disposed of correctly, this may result in fire or poisoning.

Dispose of the appliance correctly and do not damage the pipes in the refrigerant circuit.

\* Depending on the appliance features



## Customer Service

If you cannot rectify the error yourself by turning the appliance off and then on again, please contact our after-sales service. → Enclosed after-sales service directory or cover page

We will always find an appropriate solution and, where possible, prevent the need for an engineer to visit.

Please provide the after-sales service with the product number (E no.) and the production number (FD) of the appliance.

E-Nr. _____	FD _____
-------------	----------

E no.      Product number  
FD        Production number

You can find this information,  
\*depending on the model:

On the inside of the door\*/open service flap\* and at the rear of the appliance.

**You can trust in the manufacturer's expertise.**

Contact us. This ensures that the repair is carried out by trained service engineers with genuine spare parts.







---

---

---

---

---

---

---

---

---

---

---

---

---

---

---

---

---

---

---

---

---

**BSH Hausgeräte GmbH**

Carl-Wery-Straße 34

81739 München

GERMANY

[www.siemens-home.bsh-group.com](http://www.siemens-home.bsh-group.com)

Valid within Great Britain:

Imported to Great Britain by

BSH Home Appliances Ltd.

Grand Union House

Old Wolverton Road

Wolverton, Milton Keynes

MK12 5PT

United Kingdom

Manufactured by BSH Hausgeräte GmbH under the trademark licence of Siemens AG



**9001610435**

(0103)

en