

SIEMENS

Tumble dryer

WT47W461ES

en Installation and operating instructions



Register your product on My Siemens and discover exclusive services and offers.

siemens-home.bsh-group.com/welcome

The future moving in.

Siemens Home Appliances

Your new tumble dryer

You have opted for a tumble dryer manufactured by Siemens.

Please take a few minutes to read and become familiar with the advantages of your tumble dryer.

To meet the high quality demands required by Siemens, every tumble dryer that leaves our factory is carefully checked to ensure that it functions correctly and is in perfect condition.

For more information on our products, accessories, replacement parts and services, see our website www.siemens-home.bsh-group.com or contact our Customer Service centres.

If the operating and installation instructions describe different models, any differences will be pointed out at the relevant points in the text.



Read these operating and installation instructions before operating the tumble dryer.

Display rules

Warning!

This combination of symbol and signal word indicates a possibly dangerous situation. Not heeding the warning can cause death or injuries.

Caution!

This signal word indicates a possibly dangerous situation. Not heeding the caution can cause property and/or environmental damage.

Note/tip

Information about the optimum use of the appliance/any other useful information.

1. 2. 3. / a) b) c)

The steps are represented by numbers or letters.

■ / -

Lists are represented by a small box or a dash.

Contents

 Intended use	4	 Operating the appliance	27
 Safety instructions	4	Loading laundry and switching on the dryer	27
Children/people/pets	4	Setting a programme	27
Installation	6	Starting the programme	27
Operation	8	Programme sequence	28
Cleaning/Maintenance	11	Changing the programme or adding laundry	28
 Environmental protection	12	Cancelling the programme	28
Packaging/old appliance	12	Programme end	28
Coolant	12	Removing laundry and switching off the dryer	28
Energy-saving tips	13	Clean the fluff filter	29
 Installation and connection	13	Emptying the condensate container	30
Scope of delivery	13	 Signal setting	31
Installing and connecting the dryer	13	 Noises	32
Optional accessories	15	 Cleaning	33
Transport and frost protection	15	Cleaning the dryer and the control panel	33
 Draining the condensation water	16	Cleaning the moisture sensor	33
 The main points in brief	19	Cleaning the filter in the condensate container	34
 Getting to know your appliance	20	 Faults and what to do about them	35
Dryer	20	 After-sales service	37
Control panel	21	 Consumption values	38
Display panel	22	Consumption values table	38
 Laundry	23	Most efficient programme for cotton fabrics	38
Preparing the laundry	23	 Technical data	39
Sorting washing according to:	23		
 Programmes and buttons	24		
Programmes	24		
Buttons	26		



Intended use

- This appliance is intended for private domestic use only.
- Do not install or operate this appliance anywhere that is liable to experience frost and/or outdoor conditions. There is a risk that the appliance will be damaged if residual water in it freezes. If hoses freeze up, they may crack/burst.
- This appliance must only be used for drying and freshening up domestic laundry, consisting of items that have been washed with water and are suitable for tumble drying (see label on item). Using the appliance for any other purpose is outside of the scope of its intended application and is forbidden.
- This appliance is intended for use up to a maximum height of 4000 metres above sea level.

Before you switch on the appliance:

Check that there is no visible damage to the appliance. Do not operate the appliance if it is damaged. Should you have any problems, please contact your specialist dealer or our customer service.

Read and follow the operating and installation instructions and all other information provided with this appliance.

Retain the documents for subsequent use or for subsequent owners.



Safety instructions

The following safety information and warnings are provided to protect you from injury and to prevent material damage to your surroundings.

It is nevertheless important to take the necessary precautions and to proceed with care when installing, maintaining, cleaning and operating the appliance.

Children/people/pets



Warning Risk of death!

Children and other people who are unable to assess the risks involved when using the appliance may injure themselves or may find themselves in life-threatening situations. Therefore please note:

- The appliance may be used by children over the age of 8 years and by persons with reduced physical, sensory or mental capacity or by persons with a lack of experience or knowledge as long as they are supervised or have received instruction on how to use the appliance safely and they have understood the potential risks of using the appliance.
- Children must not play with this appliance.

- Do not allow children to clean or maintain this appliance unsupervised.
- Keep children under 3 years and pets away from this appliance.
- Do not leave the appliance unattended when children or other people who are unable to assess the risks are in the vicinity.

⚠ Warning
Risk of death!

Children may lock themselves inside appliances and find themselves in a life-threatening situation.

- Do not position the appliance behind a door, as this may obstruct the appliance door or prevent it from opening completely.
- Once an appliance has reached the end of its life, pull the mains plug from the socket **before** severing the mains cable, and then destroy the lock on the appliance door.

⚠ Warning
Risk of suffocation!

If allowed to play with the packaging/plastic film or packing components, children may become caught in these or pull them over their heads and suffocate.

Keep packaging, plastic film and packing components away from children.

⚠ Warning
Risk of poisoning!

Detergents and care products may result in poisoning if consumed.

If accidentally swallowed, seek medical advice. Keep detergents and care products out of the reach of children.

⚠ Warning
Eye/skin irritation!

Contact with detergents or care products may cause eye/skin irritation.

Rinse eyes/skin thoroughly if they/it come(s) into contact with detergents or care products. Keep detergents and care products out of the reach of children.

Installation

Warning

Risk of electric shock/fire/ material damage/damage to the appliance!

If the appliance is not installed properly, this may lead to a dangerous situation. Ensure the following:

- The mains voltage on your power socket must match the rated voltage specified on the appliance (identification plate). The connected loads and the required fuse protection are specified on the identification plate.
- The appliance must not be supplied through an external switching device, such as a timer, or connected to a circuit that is regularly switched on and off by a utility.
- The mains plug and the protective contact socket must match and the earthing system must be correctly installed.
- The installation must have an adequate cross section.

- The mains plug must be freely accessible at all times. If this is not possible, in order to comply with the relevant safety regulations, a switch (all pole disconnection) must be built into the permanent installation in accordance with electrical installation regulations.
- If using a residual current circuit breaker, only use one that bears the following mark: . The presence of this mark is the only way to be sure that it fulfils all the applicable regulations.

Warning

Risk of electric shock/fire/ material damage/damage to the appliance!

If the appliance's mains cable is altered or damaged, this may result in electric shock, short circuiting or fire due to overheating.

The mains cable must not be kinked, crushed or altered, and must not come into contact with any heat sources.

⚠ Warning**Risk of fire/material damage/
damage to the appliance!**

The use of extension cords or power strips may result in fire due to overheating or short circuiting.

Connect the appliance directly to an earthed socket that has been correctly installed. Do not use extension cords, power strips or multi-way couplers.

⚠ Warning**Risk of injury/material
damage/damage to the
appliance!**

- The appliance may vibrate or move when in operation, potentially resulting in injury or material damage.
Place the appliance on a clean, even, solid surface and, using a spirit level to guide you, level it with the screw-in feet.

- Incorrectly placing (stacking) this appliance on top of a washing machine may result in injury, material damage and/or damage to the appliance.
If this appliance is to be placed on top of a washing machine, the washing machine must be of at least the same depth and width as the appliance, and it must be secured in place with the appropriate connection set if available. → *Page 15*
The appliance **MUST** be secured with this connection set. Stacking the appliance in any other way is forbidden.
- If you take hold of any of the appliance's protruding parts (e.g. the appliance door) in order to lift or move it, these parts may break off and cause injury.
Do not take hold of any of the appliance's protruding parts in order to move the appliance.

Warning

Risk of injury!

- The appliance is very heavy. Lifting it may result in injury. Do not lift the appliance on your own.
- The appliance has sharp edges on which you could cut your hands. Do not take hold of the appliance by its sharp edges. Wear protective gloves to lift it.
- If the hoses and mains cables are not correctly routed, they may constitute a tripping hazard, which may result in injury. Route hoses and cables such that they do not constitute a tripping hazard.

Operation

Warning

Risk of explosions/fire!

Laundry that has come into contact with solvents, oil, wax, wax remover, paint, grease or stain remover may ignite when dried in the machine, or even cause the appliance to explode. Therefore please note:

- Rinse the laundry thoroughly with warm water and detergent before drying it in the machine.
- Do not place laundry in this appliance to be dried if the laundry has not been washed first.
- Do not use the appliance if industrial chemicals have been used to clean the laundry.

⚠ Warning**Risk of explosions/fire!**

- If there is any residual material left in the fluff filter, this may ignite when drying is in progress, or even cause the appliance to catch fire or explode. Clean the fluff filter regularly.
- Certain objects may ignite when drying is in progress, or even cause the appliance to catch fire or explode. Remove any lighters or matches from pockets on items of clothing.
- If there is coal dust or flour in the air around the appliance, this may cause an explosion. Make sure that the area around the appliance is kept clean when it is in operation.

⚠ Warning**Risk of fire/material damage/ damage to the appliance!**

The appliance contains R290, a refrigerant that is environmentally friendly but flammable.

Keep open fire and ignition sources away from the appliance.

**⚠ Warning****Risk of fire/material damage/ damage to the appliance!**

If a program is terminated before the drying cycle has finished, this prevents the laundry from cooling down sufficiently and may cause the laundry to ignite, or may result in material damage or damage to the appliance.

- During the last part of the drying cycle, the laundry in the drum is not heated (cooling cycle). This is to ensure that it remains at a temperature at which it will not be damaged.
- Do not switch off the appliance before the drying cycle has finished unless you remove all items of laundry from the drum immediately and spread them out (to dissipate the heat).

⚠ Warning**Risk of poisoning/material damage!**

Condensation water is not suitable for drinking and may be contaminated with lint. Contaminated condensation water may be hazardous to health and may cause material damage.

Do not drink or reuse.

⚠ Warning

Risk of poisoning!

Poisonous fumes may be given off by cleaning agents that contain solvents, e.g. cleaning solvent.

Do not use cleaning agents that contain solvents.

⚠ Warning

Risk of injury!

- If you support your weight/sit on the appliance door when it is open, the appliance may tip over, which may result in injury.

Do not support your weight on the appliance door when it is open.

- If you climb onto the appliance, the worktop may break, which may result in injury.

Do not climb onto the appliance.

- If you reach into the drum while it is still rotating, you risk injuring your hands. Wait until the drum has stopped rotating.

Caution!

Material damage/damage to the appliance

- If the amount of laundry in the appliance exceeds its maximum load capacity, it may not be able to operate properly, or this may result in material damage or damage to the appliance.

Do not exceed the maximum load capacity of dry laundry.

Make sure you comply with the maximum load capacities specified for each of the programs. → *Page 24*

- If you operate the appliance without a fluff catcher (e.g. fluff filter, fluff depot, depending on appliance specifications), or if the fluff catcher is incomplete or defective, this may result in damage to the appliance. Do not operate the appliance without a fluff catcher, or with a fluff catcher that is incomplete or defective.
- Light objects such as hair and lint may be sucked into the air inlet when the appliance is in operation. Keep these away from the appliance.
- Foam and foam rubber may deform or melt if dried in the appliance. Do not dry laundry items that contain foam or foam rubber in the appliance.

- If you pour the wrong quantity of detergent or cleaning agent into the appliance, this may result in material damage or damage to the appliance. Use detergents/care products/cleaning agents and softeners in accordance with the manufacturers' instructions.
- If the appliance overheats, it may not be able to operate properly, or this may result in material damage or damage to the appliance. Make sure that the appliance's air inlet is never obstructed when the appliance is in operation, and that the area around the appliance is adequately ventilated.
- When removing the mains plug from the socket, always take hold of the plug itself and never the mains cable, otherwise this may damage the mains cable.
- Do not make any technical modifications to the appliance or its features.
- Repairs and any other work on the appliance must only be conducted by our customer service or by an electrician. The same applies for replacing the mains cable (when necessary).
- Spare mains cables can be ordered from our customer service.

 Warning
Risk of poisoning!

Poisonous fumes may be given off by cleaning agents that contain solvents, e.g. cleaning solvent.
 Do not use cleaning agents that contain solvents.

 Warning
Risk of electric shock/material damage/damage to the appliance!

If moisture penetrates the appliance, this may cause it to short circuit.
 Do not use a pressure washer, steam cleaner, hose or spray gun to clean your appliance.

Cleaning/Maintenance

 Warning
Risk of death!

The appliance is powered by electricity. There is a risk of electric shock if you come into contact with live components. Therefore please note:

- Switch off the appliance. Disconnect the appliance from the power supply (pull out the plug).
- Never take hold of the mains plug with wet hands.

Warning

Risk of injury/material damage/damage to the appliance!

The use of spare parts and accessories supplied by other brands is dangerous and may result in injury, material damage or damage to the appliance.

For safety reasons, use genuine spare parts and accessories only.

Caution!

Material damage/damage to the appliance

Cleaning agents and agents for pretreating laundry (e.g. stain removers, prewash sprays, etc.) may cause damage if they come into contact with the surfaces of the appliance. Therefore please note:

- Do not allow these agents to come into contact with the surfaces of the appliance.
- Clean the appliance with nothing but water and a soft, damp cloth.
- Remove any detergent, spray or other residues immediately.



Environmental protection

Packaging/old appliance



Dispose of packaging in an environmentally-responsible manner.

This appliance is labelled in accordance with European Directive 2012/19/EU concerning used electrical and electronic appliances (waste electrical and electronic equipment - WEEE).

The guideline determines the framework for the return and recycling of used appliances as applicable throughout the EU.

Coolant

Caution!

Risk of fire/risk of poisoning/risk of material damage and damage to the appliance

The appliance contains refrigerant which, although it is environmentally friendly, is flammable R290. Failure to dispose of it properly may result in a fire or poisoning.

Dispose of the appliance properly and do not damage the pipes in the refrigerant circuit.

Energy-saving tips

- Spin the laundry before drying. The drier the laundry, the shorter the drying time will be, thus consuming less energy.
- Load the dryer with the maximum load.

Note: Do not exceed the maximum load for the programs, as this prolongs the drying time and increases energy consumption.
- Ventilate the room and keep the air inlet on the dryer free to ensure air exchange.
- Clean the fluff filter after each drying cycle. If the fluff filter is dirty, the drying time is prolonged and energy consumption is increased.
- **Energy saving mode:** If the dryer is not operated for a prolonged period, it automatically switches off before the program starts and when the program has ended to save energy. The display panel and indicator lamps go off after a few minutes and the Start button flashes. To activate the lighting, press any button, open or close the dryer door or turn the program selector.



Installation and connection

Scope of delivery

- Dryer
- Installation and operating instructions
- Basket for woollens*
- Condensation drain*

Installing and connecting the dryer



Warning

Risk of death!

There is a risk of electric shock as the dryer is operated with electricity.

- Check the dryer for visible damage. You must not operate the dryer if it is damaged.
- Before connecting the dryer to the power supply, ensure that the electric voltage specified on the rating plate matches the voltage of your socket.
- Only use residual current circuit breakers with the following symbol: .
- Ensure that the mains cable is not kinked or trapped, and that it does not come into contact with heat sources or sharp edges.



Warning

Children could lock themselves in the dryer, putting their lives at risk!

Do not set up the dryer behind a door or sliding door, as this may obstruct the dryer door or prevent it from opening.

* Depending on the model



Warning

Risk of fire/risk of poisoning/risk of material damage and damage to the appliance!

The dryer contains refrigerant which, although it is environmentally friendly, is flammable R290.

- Make sure that the air inlet on the dryer is always kept clear and that the room has sufficient ventilation.
- Do not place the dryer near open fires and ignition sources.

Caution!

Risk of injury

- As the dryer is heavy, you could injure yourself by trying to lift it. Do not lift the dryer on your own.
- You could cut your hands on the sharp edges of the dryer. Do not hold the dryer by the sharp edges.
- Protruding parts on the dryer may break off when it is lifted or pushed. Do not move the dryer by holding onto protruding parts.

Caution!

Risk of material damage to the dryer or fabrics

- Check the dryer for damage caused during transportation. Never operate a dryer if it is damaged.
- Any residual water in the dryer may freeze and damage the dryer. Do not install the dryer in rooms that are at risk of frost.

During installation, ensure that:

- The dryer is placed on a clean, level and firm surface,
- The mains plug can be accessed at all times,
- The area around the dryer is kept clean and
- The dryer is levelled using the threaded feet.

Note: Check the alignment of the appliance with a spirit level and correct if necessary. Change the height by turning the appliance feet. All appliance feet must stand firmly on the ground.

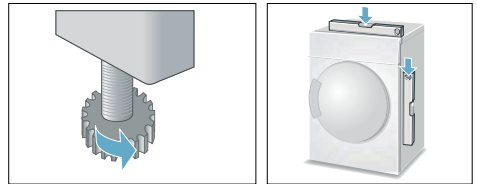

Incorrect alignment may cause high noise levels, vibrations and improper movement of the drum.

Note: If in doubt, have the appliance connected by a specialist.

Optional accessories

Order optional accessories* from the after-sales service:

- **Washer-dryer stack connection set:**
To save space, the dryer can be placed on top of a suitable washing machine of the same width and depth.
The dryer must be secured to the washing machine using this connection set.
Order number with pull-out worktop: **WZ20400**;
Order number without pull-out worktop: **WZ11410**.
- **Platform:**
For easier loading and unloading, raise your dryer with a platform.
Transport laundry with the clothes basket integrated into the platform drawer.
Order number: **WZDP20D**.
- **Basket for woollens:**
Dry individual woollen items, sports shoes and soft toys in the basket for woollens.
Order number: **WZ20600**.

Transport and frost protection

1. Empty the condensate container.
2. Select any programme using the programme selector.
3. Press the Start button.
4. Wait for 5 minutes.
Note: The condensation is drained.
5. Empty the condensate container again.
6. Switch off the dryer.

Note: Despite draining, there will always be some residual water in the dryer.

Caution!

Any residual water may leak out and cause material damage.

Transport the dryer in an upright position.

Caution!

The dryer contains coolant and may be damaged.

Allow the dryer to rest for two hours before initial use.

* Depending on the model



Draining the condensation water

Condensation will form in the appliance as it dries the laundry.

You must ensure that the drain hose is connected when you operate the appliance.

If there is no drain hose connected to the appliance, the condensation water from the appliance will run into the condensation container. In this case, you will need to empty the condensation container each time the dryer finishes drying the laundry, and also if it becomes full before drying is complete.

Connect the drain hose as follows:

1. Remove the accessories from the dryer drum.

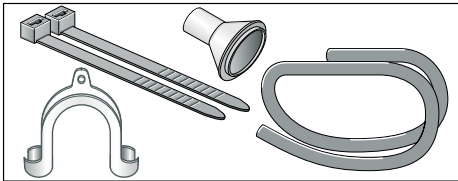

2. When the dryer is delivered from the factory, the hose for discharging the condensation into the condensation container is fastened to the connecting piece.

3. Disconnect the hose from the connecting piece and put it in the "parked" position.

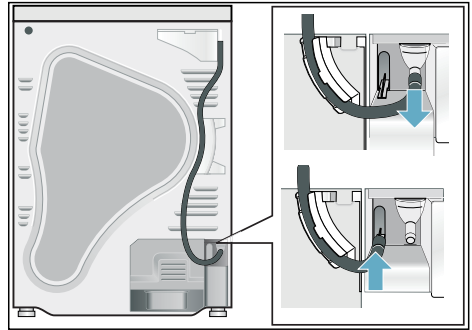

4. Take the drain hose from the accessories and secure it to the free connecting piece.

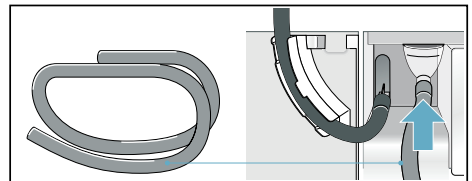

5. Fasten the other end of the drain hose with the remaining accessories, depending on the connection situation (A, B or C).

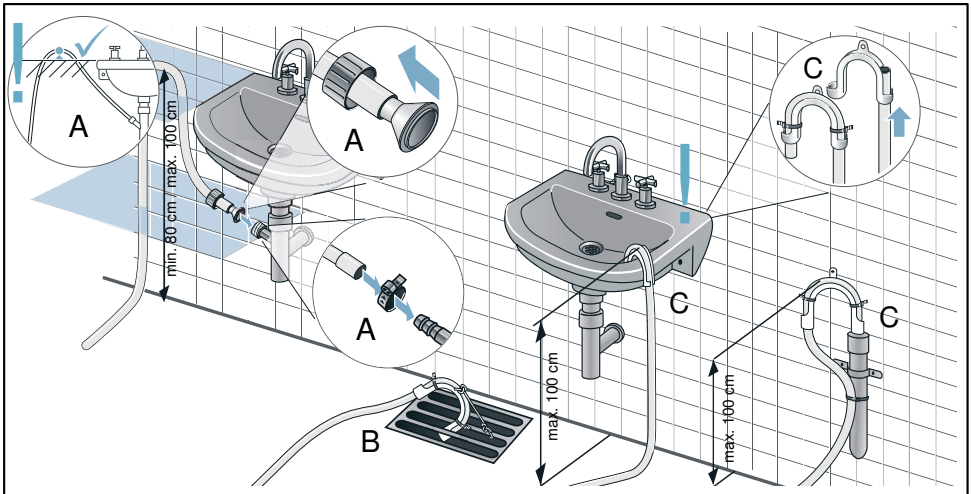

Caution!

Accumulated water can be drawn back into the dryer and may cause material damage.

Check that the water drains away from the wash basin quickly. The drain must not be sealed or blocked.

Caution!

Material damage due to leaks or draining water.

Secure the drain hose so that it cannot slip out. Do not kink the drain hose.

Ensure that a height difference of max. 100 cm and min. 80 cm between the installation surface and the drain is maintained for drainage into a siphon.

en Draining the condensation water

6. Pull out the condensation container fully.

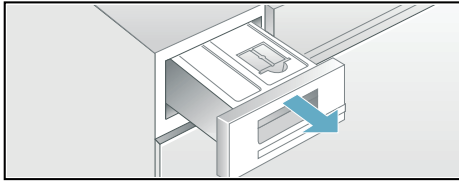

7. Turn the condensation container 180° onto its underside and remove the stopper that is fitted. Turn the condensation container back over and insert the stopper into the recess in the top of the condensation container.

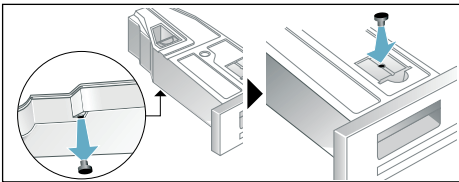

8. Pull the filter out of the lock-in slot and place it into the recess in the top of the condensation container.

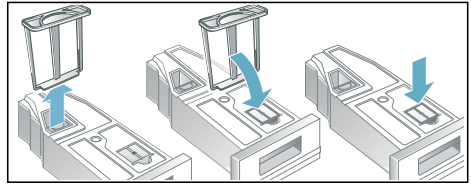

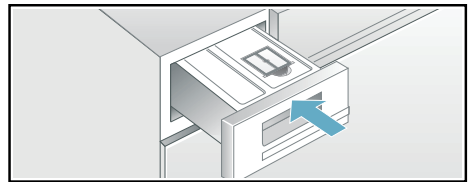

9. Slide in the condensation container until it clicks into place.



The condensation is now discharged via the drain hose into the waste-water system or into a wash basin

Note: If you want to drain the condensation water back into the condensation container, reverse these steps.

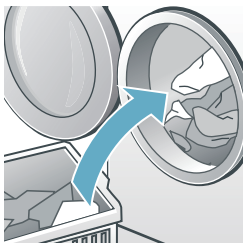
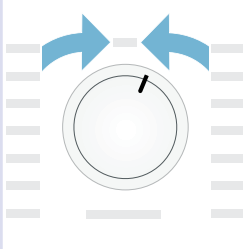
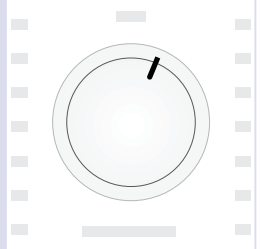
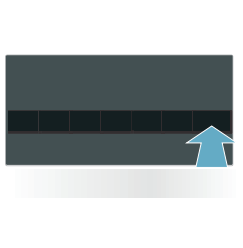
 **The main points in brief**

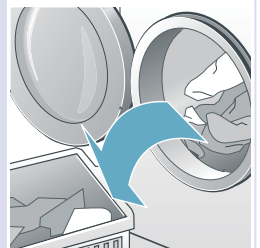
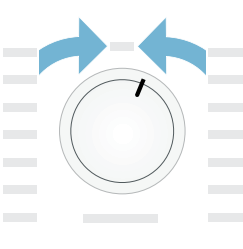
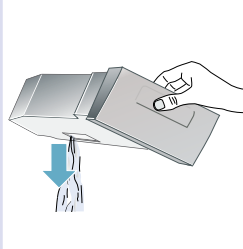
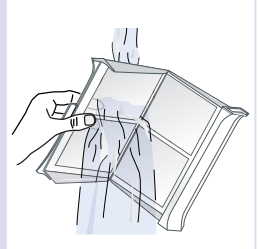
<p>1</p>		<p>➔</p>		<p>➔</p>	
	<p>Load the laundry and close the door.</p>		<p>Switch on the dryer.</p>		<p>Select a programme and, if necessary, adjust the programme default settings.</p>
<p>2</p>		<p>➔</p>		<p>➔</p>	
	<p>Select the start button ▶ .</p>		<p>Dry.</p>		<p>Unload the laundry.</p>
<p>3</p>		<p>➔</p>		<p>➔</p>	
	<p>Switch off the dryer.</p>		<p>Empty the condensate container.</p>		<p>Clean the fluff filter.</p>

Getting to know your appliance

Dryer

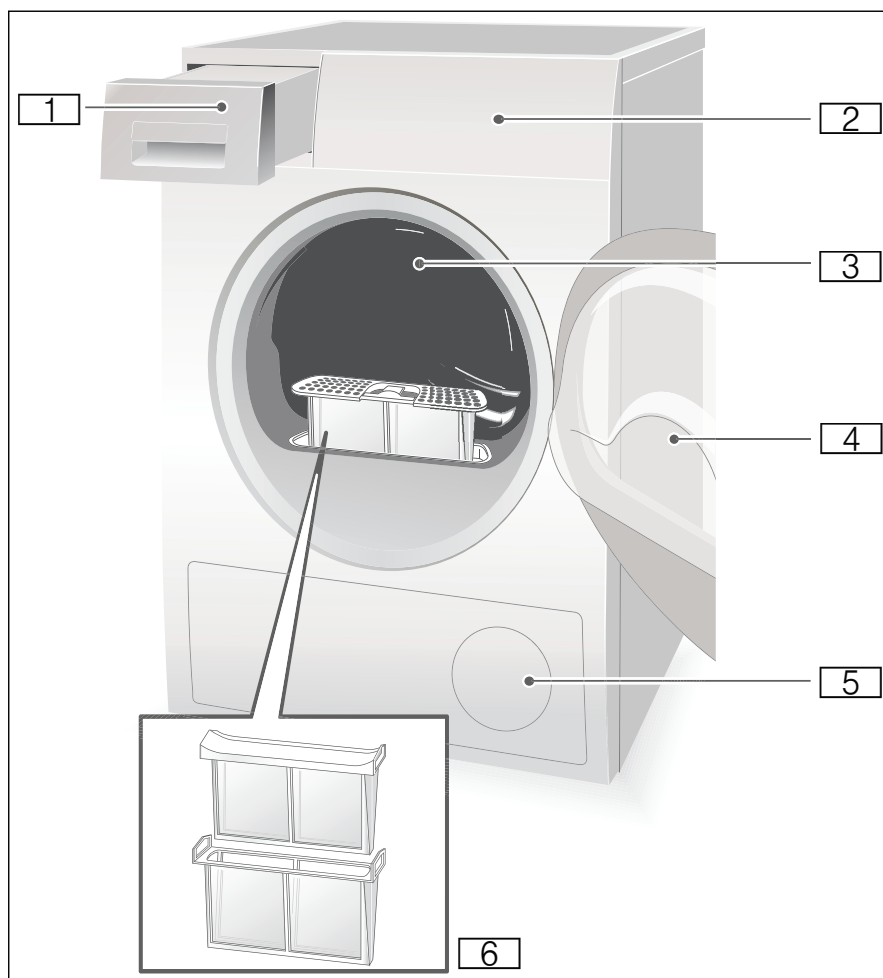

- 1** Condensate container
- 2** Control and display panel
- 3** Drum interior light (depending on the model)
- 4** Dryer door
- 5** Air inlet
- 6** Fluff filter

Control panel

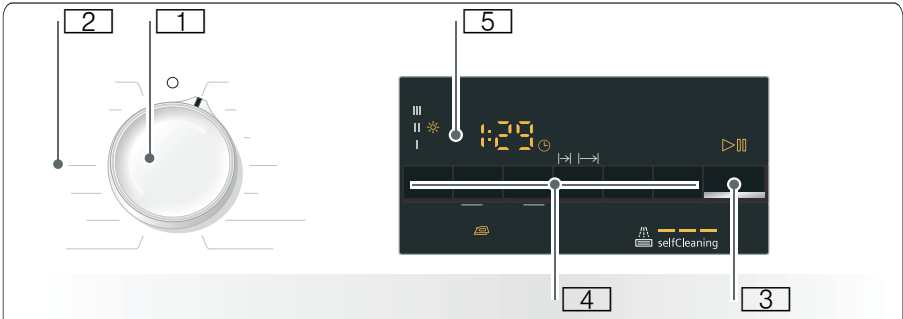

- 1 Use the **programme selector** to switch the dryer on and off and to select the programme.
- 2 **Programmes** → *Page 24.*
- 3 **Start button** for starting or interrupting the programme → *Page 26.*
- 4 **Buttons** → *Page 26.*
- 5 **Display panel with buttons** → *Page 22.*

Display panel

Buttons in the display panel

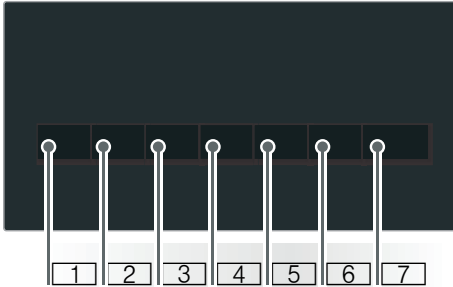







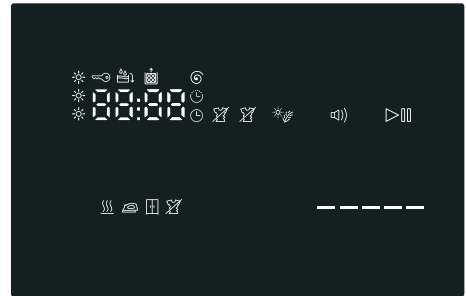







- 1 Select the **degree of dryness**.
- 2 Select the **drying time**.
- 3 Select the **Ready in time**.
- 4 Select **Anti-Crease**.
- 5 Select **Low-Heat Drying**.
- 6 Switch the **signal** on or off.
- 7 Select **Start/Pause**.

For a detailed description of all buttons, see → Page 26 onwards.

Display panel



-  Anti-Crease selected.
-  Fine adjustment of the dryness level.
-  Timed programme selected.
-  "Ready in" time selected.
-  Childproof lock selected.
-  Spin speed selected.
-  Low-Heat Drying selected.
-  Audible signal active.
-  Start or Pause selected.
- 3 h** Programme delay in hours when "Ready in" time is selected.
- 1:27** Expected programme duration in hours and minutes.
-    **End -P -**
Programme progress: Dry; Iron Dry; Cupboard Dry; Anti-Crease; End and Pause.
-  Heat exchanger is automatically cleaned.
-  Empties the condensate container; → Page 30.
-  Cleans the fluff filters; → Page 29.



Laundry

Preparing the laundry

Warning

Risk of explosion/fire!

Remove any cigarette lighters and matches from pockets.

Caution!

The dryer drum and fabrics could be damaged.

Remove all objects from pockets and observe the following information:

- Tie cloth belts, apron strings, etc. together or use a laundry bag.
- Close zips, hooks and eyelets and buttons. Button up large items of laundry, such as covers.
- Remove any metal objects, such as paper clips, from pockets.
- To ensure a consistent drying result, sort laundry by fabric type and drying programme.
- Always dry very small items of laundry, e.g. babies' socks, together with large items such as towels.
- Knitted fabrics such as T-shirts and jerseys often shrink the first time they are tumble-dried. Use a gentle programme.
- Do not overdry easy-care laundry. This increases creasing of the laundry.
- Use timed programmes for single garments.
- Some detergents and care products, e.g. starch or softeners, contain particles which may be deposited on the moisture sensor. This may impair the sensor function and in consequence the drying result.

Notes

- When washing laundry to be tumble-dried, use the correct amount of detergent and care products as specified in the manufacturer's instructions.
- Clean the moisture sensor regularly → *Page 33*.

Sorting washing according to:

- Suitable for tumble drying
- Dry at normal temperature
- Dry at low temperature
- Do not tumble-dry

Note: Do not load laundry from the washing machine directly into the tumble dryer. Sort the spun laundry before placing it in the dryer drum.

If you dry thin, thick and multi-layer fabrics together, they will dry to differing degrees. To achieve an even drying result, you should therefore only dry together laundry of the same type of fabric and structure. If you feel that the laundry is still too damp, you can select a timed programme for subsequent drying → *Page 24*.

Caution!



Possibility of material damage to the dryer or laundry.

Do not tumble-dry the following fabrics:

- Laundry contaminated with oil.
- Unwashed fabrics.
- Non-breathable fabrics (e.g. rubber-coated).
- Easily damaged fabrics such as silk, synthetic curtains.

Programmes and buttons

Programmes

Programme and fabrics	Maximum load and programme settings/info
Name of the programme Which fabrics is the programme suitable for?	The maximum load is based on the dry weight of the fabrics Possible programme settings
algodón (Cottons) extra seco p/guardar (Cupboard Dry Plus) Hard-wearing, heat-resistant fabrics that are made of more than one layer of cotton or linen and do not dry readily.	8 kg
algodón (Cottons) seco para guardar (Cupboard Dry) Normal, hard-wearing and heat-resistant fabrics made of a single layer of cotton or linen.	8 kg
algodón (Cottons) seco para (Iron Dry)  Normal, hard-wearing and heat-resistant fabrics made of a single layer of cotton or linen that need to be damp after drying and are suitable for ironing or hanging up.	8 kg
 sintéticos (Easy-Care) extra seco p/guardar (Cupboard Dry Plus) Synthetic or blended fabrics that are made of more than one layer and do not dry readily.	3.5 kg
 sintéticos (Easy-Care) seco para guardar (Cupboard Dry) Normal synthetic or blended fabrics made of a single layer.	3.5 kg
 sintéticos (Easy-Care) seco para (Iron Dry)  Normal synthetic or blended fabrics made of a single layer that need to be damp after drying and are suitable for ironing or hanging up.	3.5 kg
outdoor Weatherproof and outdoor clothing with a membrane coating and water-repellent fabrics.	1.5 kg
toallas (Towels) Hard-wearing towels made of cotton.	6 kg
mix Mixed load consisting of cotton and synthetic fabrics.	3 kg

caliente (Time programme warm) 

All types of fabric; time programme.

Suitable for pre-dried or slightly damp laundry and for drying off multi-layered, thick laundry.

Notes

- Only dry wool, sports shoes and soft toys with the basket for woollens → *Page 15*.
- In the time programme, the laundry's residual moisture is not automatically detected. If the laundry is still too damp after the drying programme, repeat the programme and, if required, extend the programme length.

3 kg

You can adjust the programme length using the button for the drying time.

frio (Timed programme cold) 

All types of fabric. For freshening up or airing items of laundry that have not been worn for long.

3 kg

You can adjust the programme length using the button for the drying time.

camisas/business (Shirts/Blouses)

Non-iron shirts or blouses made of cotton, linen, synthetic fibres or blended fabrics.

1.5 kg**express 40 min (Rapid 40)**

Synthetics and light cottons.

2 kg**acabado lana (Woollens finish)**





Fabrics made from wool or a wool blend that are suitable for tumble drying.

0.5 kg**lencería (Lingerie)**

For delicate, washable underwear, e.g. made of velvet, lace, Lycra, silk or satin.

1 kg

Buttons

Buttons	Explanations and notes
Note: Not all buttons and their functions can be selected in all programmes.	
ajuste secado (Degree of dryness)	<p>If the laundry is too damp after drying, you can finely adjust the dryness level e.g. Cupboard Dry. The dryness level can be increased with the degree of dryness in three stages, from I * to III *.</p> <p>If you have adjusted the dryness level, the setting for all programmes with a selectable dryness level is retained even after the dryer is switched off.</p> <p>Note: The higher the degree of dryness, the longer the programme duration.</p>
 (Drying time)	Adjust the programme length for the time programmes. Between 20 minutes and 3 hours, in 10-minute increments.
termin.  (Ready in)	The programme will end in 1-24 hrs. Set the "Ready in" time in increments of one hour to delay the start of the programme. The required number of hours after the programme ends is displayed in the display panel.
 (Anti-crease)	The drum moves the laundry at regular intervals for 60 or 120 minutes after drying, in any programme, to prevent creasing.
delicado (Gentle Dry)	Reduced temperature for delicate fabrics, e.g. polyacrylic or elastane. Selecting the button will extend the drying time.
 (Signal)	A signal sounds after the programme has ended.
 3 s. (Childproof lock 3 sec.)	Press and hold the "Ready in" time button and the drying time button at the same time for 3 seconds to activate or deactivate the childproof lock.
inicio/pausa + carga	Starts or pauses the programme.



Operating the appliance

Loading laundry and switching on the dryer

Note: The dryer must be correctly positioned and connected, → *Page 13*.

1. Place the laundry in the drum.
2. Turn the programme selector to any programme to switch the dryer on.
3. Close the dryer door.

Caution!

Possibility of material damage to the dryer or laundry.

Take care not to trap any laundry in the door.

Setting a programme

Note: If you have activated the childproof lock, you must deactivate it before you can set a programme, see → *Page 26*.

1. Select the required programme; detailed information on the programmes can be found from → *Page 24* onwards.
2. Use the programme selector to set the required programme. The default programme settings for the selected programme appear in the display panel.

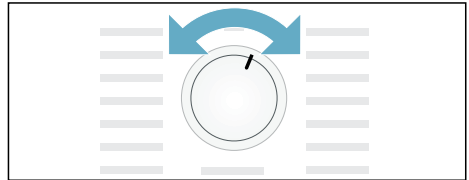

Note: Default programme settings are standard settings that are already defined when a programme is selected. After selecting a programme, you can see the default programme settings in the display panel.

3. If required, adjust the default programme settings. You can find detailed information on this from → *Page 24* onwards.

Starting the programme

Press the Start button.







Note: If you want to lock the programme to prevent it from being adjusted inadvertently, you can select the childproof lock, see → *Page 26*.

Programme sequence

The programme status is indicated in the display field.

e.g. Expected programme duration
1:27 in hours and minutes.

Note: When a programme is selected, the expected drying time for the recommended load is displayed. During drying moisture sensors detect the remaining moisture in the load and adjust the programme length (except timed programmes). This is visible via the time remaining leaping forward.

	Dry
	Iron Dry
	Cupboard Dry
	AntiCrease
	Pause
	End

Changing the programme or adding laundry

You can remove or add laundry and change or alter the programme at any time during drying.

1. To pause the programme, open the dryer door or press the Start button.
2. Add or remove laundry.
3. Select another programme or an additional function, if required.
4. Close the dryer door.
5. Press the Start button.

Note: The programme duration in the display panel is updated depending on the load and residual moisture in the laundry. The values displayed may change after the programme is changed or the load is adapted.

Cancelling the programme

The programme can be interrupted at any time; to pause, open the dryer door or press the Start button.

Caution!

Risk of fire. Laundry may catch fire.

If you cancel the programme, you must remove the laundry items and spread them out so that the heat can disperse.

Programme end

End appears in the display panel.

Removing laundry and switching off the dryer

1. Remove the laundry.
2. Turn the programme selector to the "off" position.

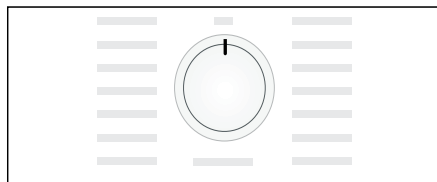

Clean the fluff filter

Note: During drying, fluff and hair from the laundry is trapped by the fluff filter. If the fluff filter is blocked or dirty, this reduces the flow of air, which prevents the dryer from achieving its maximum performance. Clean fluff filters also reduce energy consumption and the drying time.

Clean the fluff filter **after each** drying cycle:

1. Open the dryer door and remove all fluff from the door.
2. Pull out the two-part fluff filter.

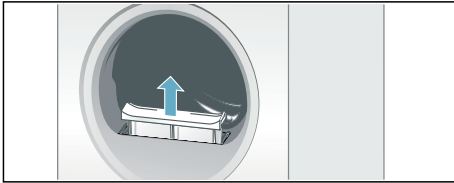

3. Remove the fluff from the recess in the fluff filter.

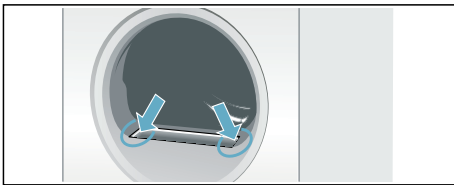

Note: Ensure that no fluff falls into the open shaft.

4. Pull apart the two-part fluff filter.

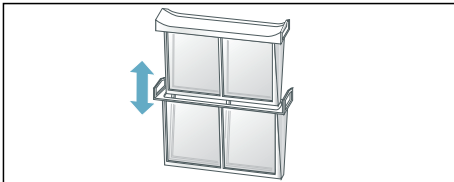

5. Open both filters and remove all the fluff.

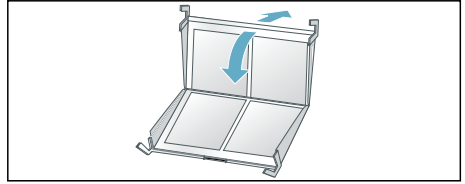

6. Rinse away the fluff under warm, running water.

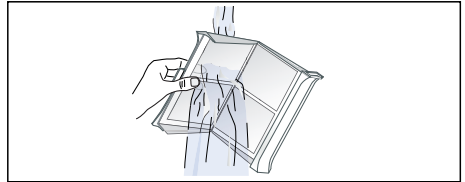

7. Dry the fluff filter, close it and reinsert the two-part fluff filter.

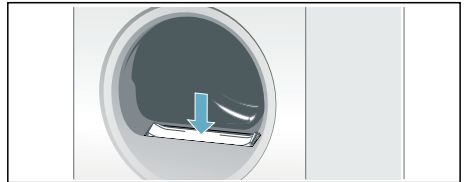

Caution!
The dryer may be damaged.

Do not operate the dryer without a fluff filter or if the fluff filter is defective.

Emptying the condensate container

By default, the condensation from the appliance runs into the condensation container.

Alternatively, you have the option of discharging the condensation water* supplied depending on the model. If you choose to discharge the condensation water into the waste-water system, you will not need to empty the condensation container during the drying programme or after each time you use the dryer.

1. Pull out the condensate container horizontally.

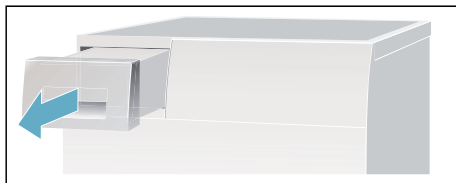

2. Pour out the condensation water.

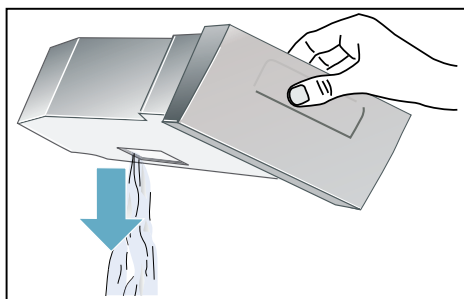

Caution!

Dirty condensation water may be harmful to your health and cause material damage.

Condensation water is not suitable for drinking and may be contaminated with fluff. Do not drink the condensation water or reuse it.

3. Push in the condensate container until you feel it lock back into place in the dryer.

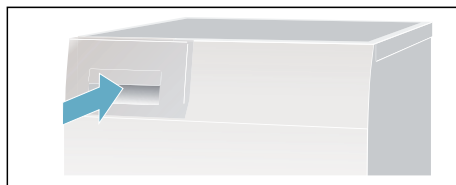

Note: The filter in the condensate container filters the condensation which is used during the dryer's automatic cleaning cycle. The filter is cleaned by emptying the condensation. Nevertheless, you should check the filter regularly for remaining deposits and remove them. See → Page 34.

* into the waste-water system via a drain hose

Signal setting

You can change the following settings:

- The speed at which the washing machine was spun; only used if the anticipated drying time needs to be displayed more accurately,
- The volume of the audible signal at the end of the programme,
- The volume of the audible button signals.

You will need to activate the setting mode in order to change these settings.

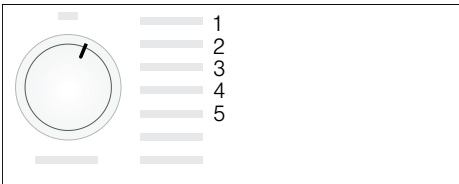

Activating setting mode

1. Switch the dryer on.
2. Select the "Cottons" programme in position 1 and wait for five seconds. Setting mode is now activated. The symbols go out in the display panel and the programme duration is displayed.

1. Press and hold the Start button and, at the same time, turn the programme selector clockwise to position 2.
2. The **spin speed** is shown in the display.
3. Press the "Ready in" time button or the drying time button to change the spin speed.
4. Turn the programme selector clockwise to position 3.

5. The volume of the **audible signal at the end of the programme** is shown in the display.



0 = off, 1 = quiet, 2 = medium, 3 = loud, 4 = very loud

6. Press the "Ready in" time button or the drying time button to change the volume.
7. Turn the programme selector clockwise to position 4.
8. The volume for the **audible button signal** is shown in the display.



0 = off, 1 = quiet, 2 = medium, 3 = loud, 4 = very loud

9. Press the "Ready in" time button or the drying time button to change the volume.

Exiting setting mode

Turn the programme selector to the "Off" position once you have set the required spin speed and the volume. The settings have now been saved.

Noises

Note: During drying, particularly in the initial phase, operation of the appliance results in noise from the compressor and pump. This is perfectly normal and does not impair proper functioning of the appliance.

From time to time, the compressor in the dryer generates a humming noise. However, the volume may vary depending on the programme and progress of the drying process.

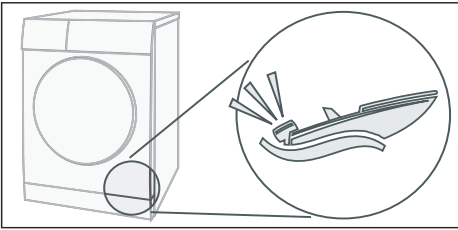

Every now and then, the compressor is ventilated. This creates a whirring noise.

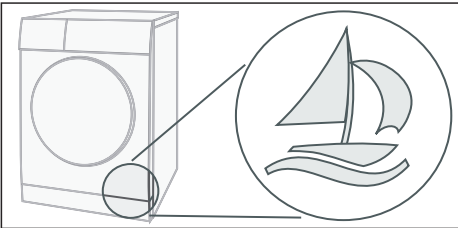

The automatic cleaning of the dryer causes a clicking sound.

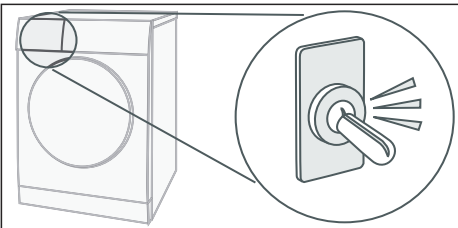

The condensation is pumped into the condensate container by a pump. This generates pumping noises.

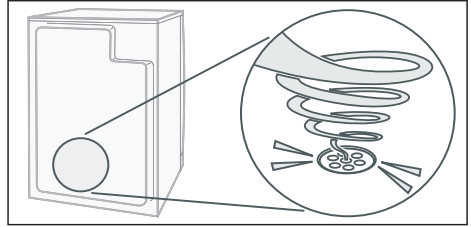



Cleaning

Cleaning the dryer and the control panel

Warning

Risk of death!

There is a risk of electric shock as the dryer is operated with electricity. Disconnect the dryer from the mains before cleaning.

Clean the dryer using only water and a soft, damp cloth.

Remove all detergent residue, spray residue or other residues immediately. Do not use cleaning agents or agents for pre-treating laundry (e.g. prewash sprays, stain removers). Do not use high-pressure cleaners or steam jet cleaners to clean your appliance.

Cleaning the moisture sensor

Note: The dryer is equipped with a stainless-steel moisture sensor. The moisture sensor measures how damp the laundry is.

After long periods of usage the moisture sensor may become covered by a fine layer of limescale or residues of detergents and care products. Such residues must be removed regularly as the sensor function and in consequence the drying result may be impaired.

Open the door and clean the moisture sensor with a coarse sponge.



Caution!

Moisture sensor may be damaged.

Do not clean moisture sensors with abrasives and steel wool.

Cleaning the filter in the condensate container

Note: The filter in the condensate container cleans the condensation water that is used during the dryer's automatic cleaning cycle.

1. Pull out the condensate container horizontally.
2. Pour out the condensation water.
3. Remove the filter.

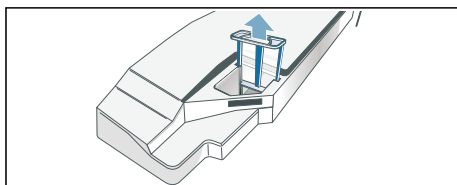

4. Clean the filter under warm, running water or in the dishwasher.

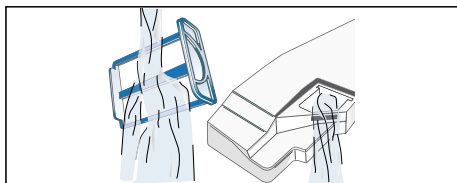

5. Push in the filter until you feel it lock into place.

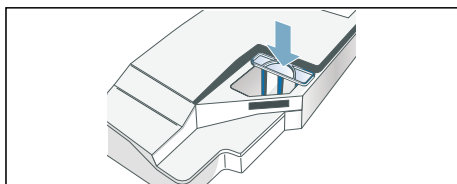



Caution!

The dryer may be contaminated with fluff and thus become damaged.

Only operate the dryer with the filter inserted.

6. Push in the condensate container until you feel it lock into place.

Faults and what to do about them

Faults	Cause/remedy
 on the display panel and drying has been interrupted.	<ul style="list-style-type: none"> ■ Empty the condensation container and press the Start button → <i>Page 30</i>. ■ If the optional condensation drain* is installed, the drain hose may be blocked or kinked. Check the hose for deposits and rinse the hose. Lay the hose without any kinks.
 on the display panel.	Clean the fluff filter and press the Start button → <i>Page 29</i> .
selfCleaning on the  display panel.	Not a fault. The heat exchanger is cleaned automatically. Do not pull out the condensation container while this is displayed.
Dryer will not start.	<ul style="list-style-type: none"> ■ Mains plug plugged in or fuse checked? ■ Programme selected? Select a programme. ■ Dryer door open? Close the door. ■ Is the childproof lock activated? Deactivate childproof lock. ■ "Ready in" time selected? Programme starts after a delay → <i>Page 26</i>.
Creasing.	<ul style="list-style-type: none"> ■ Creasing occurs when you have exceeded the maximum load or selected the wrong programme for the type of fabric. All the required information can be found in the programme table → <i>Page 24</i>. ■ Remove clothes immediately after drying; creasing will occur if they are left in the drum.
Water is leaking out.	Not a fault; the dryer may be sloping. Level the dryer.
Change in the programme duration displayed during drying.	Not a fault. The moisture sensors detect the remaining moisture in the load and adjust the programme length (except timed programmes).
Laundry is not dried correctly or is still too damp.	<ul style="list-style-type: none"> ■ After the programme has ended, warm laundry feels damper than it actually is. Spread the laundry out and allow the heat to disperse. ■ Finely adjust the dryness level – this extends the drying time but does not increase the temperature. Your laundry will become drier → <i>Page 26</i>. ■ Select a programme with a longer drying time or increase the dryness level. This does not increase the temperature. ■ Select a timed programme to add extra drying time for laundry that is still damp → <i>Page 24</i>. ■ If you have exceeded the maximum load for the programme, the laundry may not be dried properly. ■ Clean the moisture sensor in the drum. The sensor may become covered by a fine layer of limescale or residues of detergents and care products which then impair its function. Your laundry is not being dried correctly → <i>Page 33</i>. ■ Drying has been interrupted as a result of a power cut, because the condensation container is full or because the maximum drying time has been exceeded. <p>Note: See also the laundry tips → <i>Page 23</i>.</p>

* Depending on the model

Faults	Cause/remedy
Drying time too long?	<ul style="list-style-type: none"> ■ The fluff filter may be dirty and cause a longer drying time. Clean the fluff filter. ■ If the air inlet on the dryer is blocked or not freely accessible, this may increase the drying time. Make sure that the air inlet remains unobstructed. ■ The optimum ambient temperature for drying is between 15 °C and 30 °C. Outside of this range, the drying time may increase. ■ Insufficient air circulation in the room may increase the drying time. Ventilate the room.
Display panel goes off and Start button flashes.	Not a fault. Energy-saving mode is active → <i>Page 13</i> .
Residual water in the condensation container despite the dryer being connected to the condensation drain*.	Not a fault. If the condensation drain is installed, residual water remains in the condensation container due to the dryer's self-cleaning function.
Humidity in the room increases.	Not a fault. Make sure the room is sufficiently ventilated.
Power cut.	The drying programme is interrupted. Remove the laundry and spread it out or restart the programme.
Unusual noises when drying.	Not a fault. Noises are produced by the automatic cleaning of the heat exchanger → <i>Page 32</i> .
The dryer feels cold despite drying.	Not a fault. The dryer can dry efficiently at low temperatures using a heat pump.
* Depending on the model	

Note: If you cannot rectify the fault yourself by turning the dryer off and then on again, please contact our after-sales service.



After-sales service

After-sales service

If you cannot rectify the fault yourself (faults, what to do?), please contact our after-sales service. We will always find an appropriate solution to avoid unnecessary visits by engineers.

The contact information for your nearest after-sales service can be found here or in the enclosed after-sales service directory.

Please provide after-sales service with the dryer's product number (E-no.) and production number (FD).

E-Nr. _____ FD _____

You can find this information on the inside of the dryer door or on the rear of the dryer.

Trust the expertise of the manufacturer.

Contact us. You can therefore be sure that the repair is carried out by trained service technicians who carry original spare parts.



Consumption values

Consumption values table

Programme	Spin speed used for spinning the laundry	Duration**		Energy consumption**	
		8 kg	4 kg	8 kg	4 kg
Cottons					
Cupboard Dry*	1400 rpm	132 min	86 min	1.20 kWh	0.72 kWh
	1000 rpm	148 min	94 min	1.42 kWh	0.83 kWh
	800 rpm	164 min	103 min	1.64 kWh	0.94 kWh
Iron Dry*	1400 rpm	96 min	61 min	0.87 kWh	0.51 kWh
	1000 rpm	112 min	69 min	1.09 kWh	0.62 kWh
	800 rpm	128 min	78 min	1.31 kWh	0.73 kWh
Easy-Care		3.5 kg		3.5 kg	
Cupboard Dry*	800 rpm	56 min		0.43 kWh	
	600 rpm	65 min		0.53 kWh	

* Programme setting for testing in accordance with the applicable EN 61121 standard.

** The values may differ from those specified, depending on the type of fabric, composition of laundry to be dried, residual moisture in the laundry, the degree of dryness that has been set, the amount of laundry being loaded, the environmental conditions, and any additional functions that have been activated.

Most efficient programme for cotton fabrics

The following "standard cottons programme" (identified with ) is suitable for drying normal, wet cotton laundry and is most efficient in terms of its combined energy consumption for drying wet cotton laundry.

Standard programmes for cottons in accordance with current EU regulation 932/2012			
Programme	Load	Energy consumption	Programme length
 Cottons + Cupboard Dry	8 kg/4 kg	1.42 kWh/0.83 kWh	148 min./94 min.

Programme setting for testing and energy labelling in accordance with Directive 2010/30/EU.



Technical data

Dimensions:

85 x 60 x 60 cm

Height x width x depth

Weight:

Approx. 56 kg

Maximum load:

8 kg

Condensate container:

4.6 l

Connected voltage:

220 - 240 V

Connected load:

Max. 1000 W

Fuse:

10 A

Drum interior light***Ambient temperature:**

5 - 35 °C

**Power consumption when
switched off:**

0.10 W

**Power consumption when
ready for use (left-on mode):**

0.50 W

This product contains light sources from energy efficiency class F. These light sources are available as a spare part and must only be replaced by trained specialist staff.

* Depending on the model

BSH Hausgeräte GmbH

Carl-Wery-Straße 34

81739 München

GERMANY

www.siemens-home.bsh-group.com

Valid within Great Britain:

Imported to Great Britain by

BSH Home Appliances Ltd.

Grand Union House

Old Wolverton Road

Wolverton, Milton Keynes

MK12 5PT

United Kingdom

Manufactured by BSH Hausgeräte GmbH under the trademark licence of Siemens AG



9001606622

(0101)

en