



Register your
new device on
MyBosch now and
get free benefits:
**[bosch-home.com/
welcome](https://bosch-home.com/welcome)**



Steamer

CDG634A.0

[en] User manual and installation instructions

Table of contents

USER MANUAL

1	Safety	2
2	Avoiding material damage	4
3	Environmental protection and saving energy	4
4	Familiarising yourself with your appliance	5
5	Accessories	7
6	Before using for the first time	8
7	Basic operation	9
8	Time-setting options	11
9	Dishes	13
10	Childproof lock	15
11	Basic settings	15
12	Cleaning and servicing	16
13	Troubleshooting	21
14	Disposal	24
15	How it works	24
16	Customer Service	33
17	INSTALLATION INSTRUCTIONS	33
17.1	General installation instructions	33

1 Safety

Observe the following safety instructions.

1.1 General information

- Read this instruction manual carefully.
- Keep the instruction manual and the product information safe for future reference or for the next owner.
- Do not connect the appliance if it has been damaged in transit.

1.2 Intended use

This appliance is designed only to be built into kitchen units. Read the special installation instructions.

Only a licensed professional may connect appliances without plugs. Damage caused by incorrect connection is not covered under the warranty.

Only use this appliance:

- To prepare meals and drinks.
- In private households and in enclosed spaces in a domestic environment.
- Up to an altitude of max. 2000 m above sea level.

1.3 Restriction on user group

This appliance may be used by children aged 8 or over and by people who have reduced physical, sensory or mental abilities or inadequate experience and/or knowledge, provided that they are supervised or have been instructed on how to use the appliance safely and have understood the resulting dangers.

Children must not play with the appliance. Children must not perform cleaning or user maintenance unless they are at least 15 years old and are being supervised. Keep children under the age of 8 years away from the appliance and power cable.

1.4 Safe use

Follow these instructions when using a steam function. Always place accessories in the cooking compartment the right way round.
→ "Accessories", Page 7

WARNING – Risk of burns!

The appliance and its parts that can be touched become hot during use.

- ▶ Caution should be exercised here in order to avoid touching heating elements.
- ▶ Young children under 8 years of age must be kept away from the appliance.
- ▶ Never touch the ventilation openings. Accessories and cookware get very hot.
- ▶ Always use oven gloves to remove accessories or cookware from the cooking compartment.

WARNING – Risk of scalding!

The accessible parts of the appliance become hot during operation.

- ▶ Never touch these hot parts.
- ▶ Keep children at a safe distance. Hot steam may escape when you open the appliance door. Steam may not be visible, depending on the temperature.
- ▶ When opening the door, do not stand too close to the appliance.
- ▶ Open the appliance door carefully.

- ▶ Keep children at a safe distance.
- If there is water in the cooking compartment when it is hot, this may create hot steam.
- ▶ Never pour water into the cooking compartment when the cooking compartment is hot.

The water in the evaporator dish is still hot even after the appliance has been switched off.

- ▶ Never empty the evaporator dish immediately after switching off the appliance.
- ▶ Allow the appliance to cool down before cleaning.

Hot liquid may spill over the sides of the accessory when it is removed from the cooking compartment.

- ▶ Remove hot accessories with care and always wear oven gloves.

⚠ WARNING – Risk of injury!

Scratched glass in the appliance door may develop into a crack.

- ▶ Do not use any harsh or abrasive cleaners or sharp metal scrapers to clean the glass on the appliance door, as they may scratch the surface.

⚠ WARNING – Risk of fire!

Due to the hot surfaces, vapours from flammable liquids may catch fire in the cooking compartment (explosion). The appliance door may spring open. Hot steam and jets of flame may escape.

- ▶ Do not pour flammable liquids (e.g. alcoholic drinks) into the water tank.
- ▶ Only fill the water tank with water or with the descaling solution we have recommended.

⚠ WARNING – Risk of electric shock!

Incorrect repairs are dangerous.

- ▶ Repairs to the appliance should only be carried out by trained specialist staff.
- ▶ Only use genuine spare parts when repairing the appliance.
- ▶ If the power cord of this appliance is damaged, it must be replaced by trained specialist staff.

If the insulation of the power cord is damaged, this is dangerous.

- ▶ Never let the power cord come into contact with hot appliance parts or heat sources.

- ▶ Never let the power cord come into contact with sharp points or edges.
- ▶ Never kink, crush or modify the power cord.

An ingress of moisture can cause an electric shock.

- ▶ Do not use steam- or high-pressure cleaners to clean the appliance.

If the appliance or the power cord is damaged, this is dangerous.

- ▶ Never operate a damaged appliance.
- ▶ Never operate an appliance with a cracked or fractured surface.
- ▶ Never pull on the power cord to unplug the appliance. Always unplug the appliance at the mains.
- ▶ If the appliance or the power cord is damaged, immediately unplug the power cord or switch off the fuse in the fuse box.
- ▶ Call customer services. → *Page 33*

When changing the bulb, the bulb socket contacts are live.

- ▶ Before replacing the bulb, ensure that the appliance is switched off in order to prevent a potential electric shock.
- ▶ Also unplug the appliance from the mains or switch off the circuit breaker in the fuse box.

⚠ WARNING – Danger: Magnetism!

Permanent magnets are used in the control panel or in the controls. These may affect electronic implants, e.g. heart pacemakers or insulin pumps.

- ▶ Wearers of electronic implants must stay at least 10 cm away from the control panel.

⚠ WARNING – Risk of suffocation!

Children may put packaging material over their heads or wrap themselves up in it and suffocate.

- ▶ Keep packaging material away from children.
- ▶ Do not let children play with packaging material.

Children may breathe in or swallow small parts, causing them to suffocate.

- ▶ Keep small parts away from children.
- ▶ Do not let children play with small parts.

2 Avoiding material damage

ATTENTION!

Silicone bakeware is not suitable for combined operation with steam.

▶ Cookware must be heat- and steam-resistant. Using cookware with rust spots may cause corrosion in the cooking compartment. Even the smallest spots of rust can cause corrosion.

▶ Do not use cookware with rust spots. Dripping liquids make the cooking compartment floor dirty.

▶ When steaming with a perforated cooking container, always place the baking tray, the universal pan or the unperforated cooking container underneath. This will catch any liquid that drips down.

If descaling solution comes into contact with the control panel or other delicate surfaces, it will damage them.

▶ Remove descaling solution immediately with water. Cleaning the water tank in the dishwasher will damage it.

▶ Do not clean the water tank in the dishwasher.
▶ Clean the water tank with a soft cloth and standard washing-up liquid.

With certain models, accessories may scratch the door pane when closing the appliance door.

▶ Always push accessories fully into the cooking compartment.

Sitting or placing objects on the appliance door may damage it.

▶ Do not place or hang objects on the appliance door.
▶ Do not place cookware or accessories on the appliance door.

If the seal is very dirty, the appliance door will no longer close properly during operation. This may damage the front of adjacent kitchen units.

▶ Keep the seal clean at all times.

▶ Never operate the appliance if the seal is damaged or missing.

The prolonged presence of moisture in the cooking compartment leads to corrosion.

▶ Allow the cooking compartment to dry after use.
▶ Do not keep moist food in the cooking compartment for a long time with the door closed.

▶ Do not store food in the cooking compartment. If aluminium foil comes into contact with the door pane, it could cause permanent discolouration.

▶ Do not allow aluminium foil in the cooking compartment to come into contact with the door pane.

Improper care may lead to corrosion in the cooking compartment.

▶ Observe the care and cleaning instructions.
▶ Once the appliance has cooled down, remove any dirt from the cooking compartment.

Carrying the appliance by the door handle could break it. The door handle cannot support the weight of the appliance.

▶ Do not carry or hold the appliance by the door handle.

A build-up of heat damages the appliance.

▶ Never place accessories, foil, greaseproof paper or ovenware on the cooking compartment floor.
▶ Never cover the cooking compartment floor with any type of foil.

▶ Keep the cooking compartment floor and the evaporator tray clear.

▶ Always place the cookware in a perforated cooking container.

Hot water in the water tank may damage the steam system.

▶ Only fill the water tank with cold water.

3 Environmental protection and saving energy

3.1 Disposing of packaging

The packaging materials are environmentally compatible and can be recycled.

▶ Sort the individual components by type and dispose of them separately.

3.2 Saving energy

If you follow these instructions, your appliance will use less power.

Only preheat the appliance if the recipe or the recommended settings → *Page 24* tell you to do so.

■ Not preheating the appliance can reduce the energy used by up to 20%.

Open the appliance door as little as possible during operation.

■ This will maintain the temperature in the cooking compartment and eliminate the need for the appliance to reheat.

Cook food on multiple levels at the same time. Put the food with the longest cooking time in first.

■ If you are preparing the food at the same time, shorten the operating time.

4 Familiarising yourself with your appliance

4.1 Controls

You can use the control panel to configure all functions of your appliance and to obtain information about the operating status.

Note: On certain models, specific details such as colour and shape may differ from those pictured.

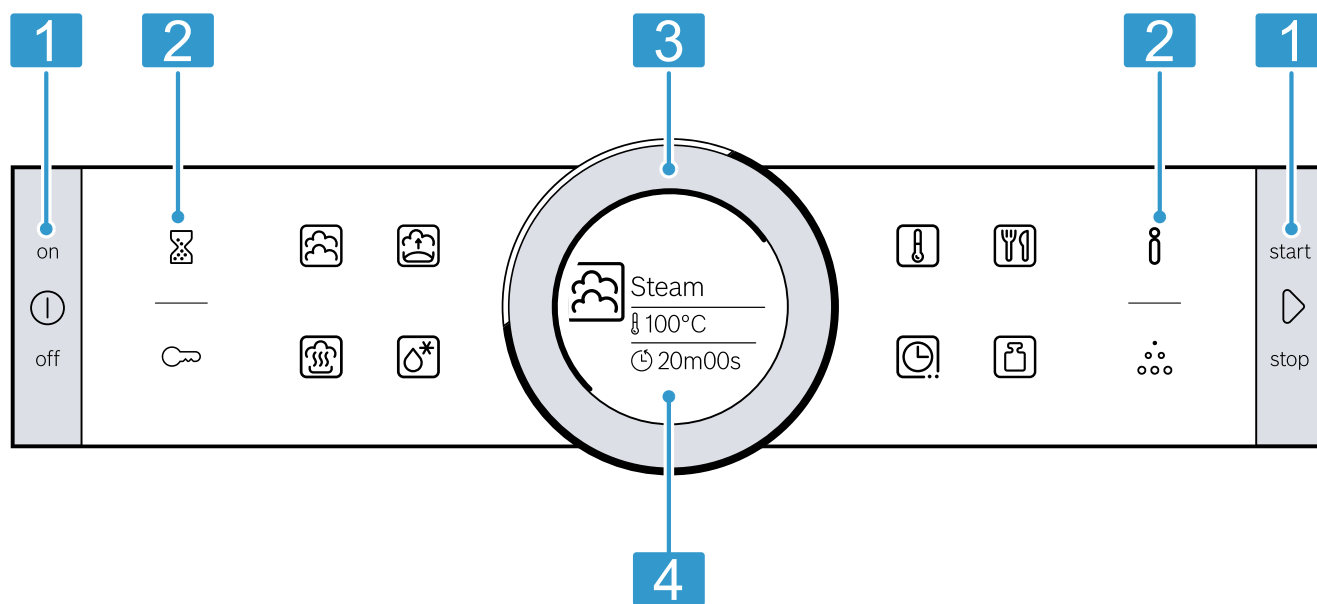





1	Buttons	The buttons have a pressure point. Press the buttons to actuate them.
2	Touch keys	There are sensors under the touch keys. To select a function, press the relevant touch key.
3	Control ring	You can turn the control ring infinitely in either direction. To use the control ring, press down lightly on it and turn it in the direction you require.
4	Display	The display shows the current setting values, options and notifications.

Buttons and touch keys

Touch fields are touch-sensitive surfaces. To select a function, touch the relevant field.

Sym-bol	Name	Description
ⓘ	On/off	Switches the appliance on and off.
ⓘ	Information	When the appliance is on: Displays additional information. When the appliance is off: Calls up the basic settings if you press and hold the button for approx. 3 seconds.
⌚	Time-setting options	Selects the time-setting options.

Sym-bol	Name	Description
🔒	Childproof lock	Activates the childproof lock. Press and hold for approx. 4 seconds to deactivate the childproof lock.
▶	Start/stop	Starts, pauses or cancels operation (press and hold for approx. 3 seconds to cancel operation).
⌚	Timer	Selects the timer.
☁	Steam	Selects the "Steam" function.
🍞	Dough proving	Selects the "Dough proving" function.
⋮	Descal	Selects "Descal".

Sym- bol	Name	Description
	Reheat	Selects the "Reheat" function.
	Defrost	Selects the "Defrost" function.
	Temperature	Selects the temperature in the cooking compartment.
	AutoPilot	Selects "Dishes" mode with cooking programs.
	Weight	Selects the weight for "Dishes" mode.

Control ring

You can use the rotary selector to change the setting values shown on the display.
For values, e.g. temperature, you have to turn the control ring back the other way when you reach the minimum or maximum value.

Display

The display shows the current setting values at different levels.

Value in the foreground	The value in the foreground is highlighted in white. You can use the control ring to change the value directly.
Value in the background	Values in the background are displayed in grey. To change the value using the control ring, first select the required function.
Magnified value	While you are using the control ring to change a value, this value will appear magnified.

Display ring

There is a display ring around the outside of the display.

- Position indicator
If you are changing a value, the display ring shows you where you are in the selection list. Depending on the settings range and the length of the selection list, the display ring may be either a continuous or a segmented line.
- Progress indicator
During operation, the display ring displays the progress and the red line increases in length every second.
If the cooking time is set to count down, one segment of the display ring disappears every second.

Temperature indicator





The heat-up line indicates the temperature in the cooking compartment.

- Heat-up line
Once operation has started, the white line below the temperature turns red as the cooking compartment heats up. When you are preheating the appliance, the optimal time to place your food in the cooking compartment is as soon as the entire line has turned red.
- Residual heat indicator
When the appliance is switched off, the display ring shows the residual heat in the cooking compartment. As the residual heat dissipates, the display ring gets darker before eventually disappearing completely.

Note: Due to thermal inertia, the temperature displayed may differ slightly from the actual temperature inside the cooking compartment.

4.2 Heating functions

Here you can find an overview of the types of heating. You can find recommendations on using the types of heating. When you select a type of heating, the appliance suggests a suitable temperature or setting. You can use these values or change them within the specified range.

Symbol	Name	Temperature	Use
	Steam	30-100 °C	For blanching and steaming: <ul style="list-style-type: none"> ■ Vegetables ■ Fish ■ Side dishes Juicing fruit.
	Reheat	80-100 °C	Suitable for plated meals. The steam type of heating gently warms cooked food. The steam ensures that the food does not dry out.
	Prove dough	30-50 °C	Suitable for yeast dough. The yeast dough proves more quickly than at room temperature. The surface of the dough does not dry out.
	Defrost	30-60 °C	Suitable for fruit and vegetables. The steam type of heating uses moisture to transfer the heat to the food, gently warming it without impairing its quality. The food does not dry out or lose its shape.

4.3 Viewing additional information

You can usually call up additional information about the function you have just started. The appliance automatically displays certain notifications, such as warnings, prompts or dialogues that require confirmation.

1. Press **i**.
 - ✓ The additional information will be displayed for a few seconds.
2. Use the control ring to scroll through longer passages of text.

4.4 Cooking compartment

The functions in the cooking compartment make your appliance easier to use.

Interior lighting

When you open the appliance door, the light in the cooking compartment switches on. If the appliance door remains open for longer than 15 minutes, the light switches off again.

In most operating modes, the interior lighting switches on as soon as operation starts. The interior lighting switches off again when operation stops.

You can specify whether you want the interior lighting to switch on during operation in the basic settings.

→ Page 15

Cooling fan

The cooling fan switches on and off as required. The hot air escapes above the door.

ATTENTION!

Covering the ventilation slots will cause the appliance to overheat.

- ▶ Do not cover the ventilation slots.

To cool the cooking compartment more quickly after operation, the cooling fan continues to run for a certain period afterwards.

You can specify how long the cooling fan should continue to run by going to the basic settings. → Page 15

Shelf positions

The shelf positions are numbered from bottom to top.

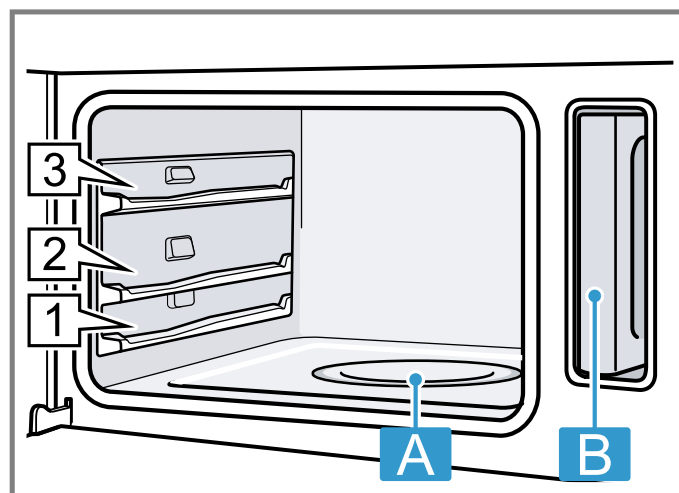

- A** Evaporator dish
- B** Water tank in the water tank recess

4.5 Appliance door

If you open the appliance door while the appliance is in operation, this pauses operation. When you close the appliance door, operation will resume automatically.

5 Accessories

Use original accessories. These have been made especially for your appliance.

Note: Accessories may become deformed if they get hot. Deformation has no effect on function. As the accessory cools down, it will regain its original shape.

The accessories supplied may differ depending on the appliance model.

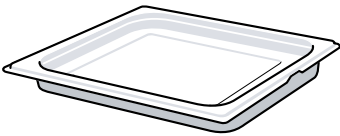
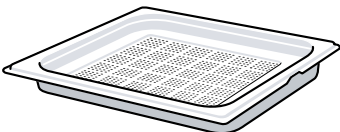
Accessories	Properties	Use
Steam container, solid, size L		<ul style="list-style-type: none"> ■ Boil rice, pulses or cereals ■ Catch dripping liquid, e.g. when steaming
Perforated steam container, size L		<ul style="list-style-type: none"> ■ Steam whole fish or larger quantities of vegetables ■ Juice large quantities of berries

en Before using for the first time

5.1 Locking function

The locking function prevents the accessories from tilting when they are pulled out. You can pull out the accessories approximately halfway without them tipping. The accessories must be inserted into the cooking compartment correctly for the tilt protection to work properly.

5.2 Inserting the steaming tray

ATTENTION!

A build-up of heat damages the appliance.

- ▶ Never place accessories, foil, greaseproof paper or ovenware on the cooking compartment floor.
- ▶ Never cover the cooking compartment floor with any type of foil.
- ▶ Keep the cooking compartment floor and the evaporator tray clear.
- ▶ Always place the cookware in a perforated cooking container.

1. Rotate the steaming tray such that the latching cutout **a** is towards the rear and its shape is pointing upwards.

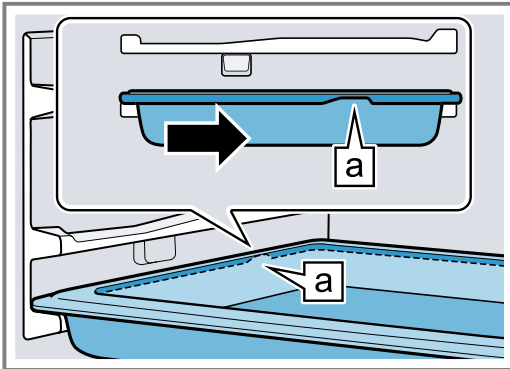

2. Do not push the steaming tray beyond the recess **b**.

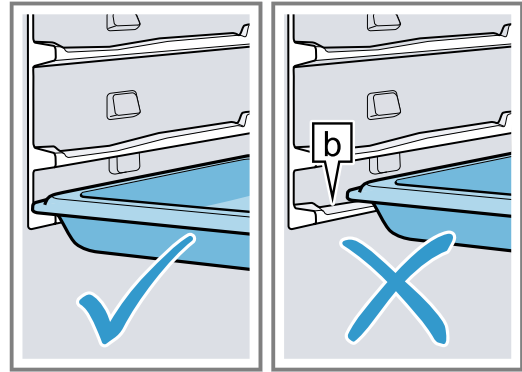

3. Take hold of the steaming tray in the middle to insert it.

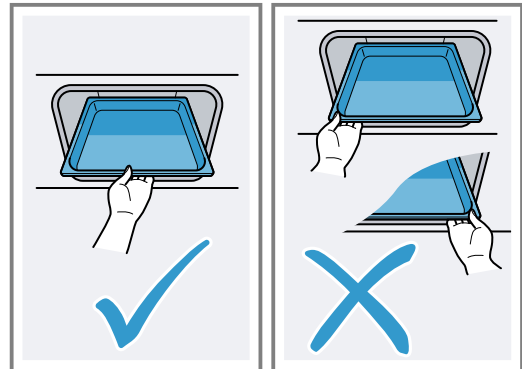

5.3 Other accessories

You can purchase other accessories from our after-sales service, specialist retailers or online. You will find a comprehensive range of products for your appliance in our brochures and online: www.bosch-home.com

Accessories vary from one appliance to another. When purchasing accessories, always quote the exact product number (E no.) of your appliance. You can find out which accessories are available for your appliance in our online shop or from our after-sales service.

6 Before using for the first time

Configure the settings for initial start-up. Clean the appliance and accessories.

6.1 Water hardness range

Before using the appliance for the first time, ask your water supplier about the hardness of your tap water. To ensure that the appliance can reliably remind you to descale it when required, you must set your water hardness range correctly.

ATTENTION!

If the wrong water hardness has been set, the appliance cannot remind you to descale it at the right time.

- ▶ Set the water hardness correctly.
- Using unsuitable liquids may damage the appliance.
- ▶ Do not use distilled water, highly chlorinated tap water (>40 mg/l) or other liquids.

- ▶ Only use cold, fresh tap water, softened water or non-carbonated mineral water.

Notes

- If you use mineral water, set the water hardness range to "very hard". If you are using mineral water, you must only use non-carbonated mineral water.
- If your tap water is very hard, we recommend that you use softened water. If you use only softened water, set the "softened" water hardness range.

Setting	Water hardness in mmol/l	German hardness °dH	French hardness °fH
00 (softened) ¹	-	-	-
01 (soft)	Up to 1.5	Up to 8.4	Up to 15
02 (medium)	1.5-2.5	8.4-14	15-25
03 (hard)	2.5-3.8	14-21.3	25-38
04 (very hard) ²	Over 3.8	Over 21.3	Over 38

¹ Only set this if you will be using solely softened water.

² Also set for mineral water. Only use non-carbonated mineral water.

6.2 Initial configuration

When the appliance is connected to the power supply for the first time or following a lengthy power failure, the settings that you will need to configure before you can use it will appear.

Note: You can change these settings at any time by going to the basic settings.

→ "Basic operation", Page 9

Setting the language

1. Use the control ring to set the required language.
 2. Press .
- ✓ The next setting will appear.

Setting the time

1. Use the control ring to set the current time.
 2. Press .
- ✓ The next setting will appear.

Setting the water hardness

1. Use the control ring to set the water hardness range.
 2. Press .
- ✓ This saves the water hardness range.
 ✓ A message will now appear on the display confirming that initial configuration is complete.
 ✓ The current time will be displayed.

6.3 Calibrating the appliance

The boiling point of water depends on the air pressure. During the calibration process, the appliance adjusts to the pressure conditions in the location where it is installed. Large amounts of steam may be generated during the calibration process.

Running the calibration process

Notes

- Do not open the appliance door while calibration is in progress as this will abort the calibration process.
- If you move house, restore the appliance's basic factory settings once it is installed so that it can adapt to its new location. Repeat the procedures for initial configuration and calibration.

- Your appliance will retain these calibration settings even in the event of a power failure or disconnection from the mains. Recalibration is not necessary.

Requirement: The cooking compartment is cold or at room temperature.

1. Remove the accessories and any leftover packaging (e.g. polystyrene pellets) from the cooking compartment.
2. Wipe the smooth surfaces in the cooking compartment with a soft, damp cloth.
3. Press  to switch on the appliance.
4. Fill the water tank.
→ "Filling the water tank", Page 10
5. Set the required heating function, temperature and cooking time.
→ "Setting the heating function and temperature", Page 11

Setting	Value
Heating function	Steam 
Temperature	100 °C
Cooking time	20 minutes

6. Press  to switch the appliance off.
7. Wait until the cooking compartment has cooled down.

6.4 Cleaning the cooking compartment

Requirement: The cooking compartment is cold or at room temperature.

1. Clean the smooth surfaces with soapy water and a dish cloth.
2. Empty and dry the water tank.
3. Dry the cooking compartment.

6.5 Cleaning the accessories

- ▶ Clean the accessories with soapy water and a dish cloth or soft brush.

7 Basic operation

7.1 Switching on the appliance

- ▶ Press  to switch the appliance on.
- ✓ The Bosch logo will appear on the display, followed by the heating function selection list.

7.2 Switching off the appliance

- ▶ Press  to switch the appliance off.
- ✓ The appliance will now shut down. Any functions currently in progress will be aborted.

- ✓ The time or the residual heat indicator will appear on the display.

7.3 Starting the appliance

- ▶ To start the appliance, press \triangleright .
- ✓ The settings, the run time, the display ring and the heat-up line will appear on the display.

7.4 Pausing or cancelling operation

You can cancel operation at any time.

1. To pause operation, open the cooking compartment door or press \triangleright .
 - ✓ The fan may continue to run after operation has been paused or stopped.
2. To resume operation, close the cooking compartment door or press \triangleright again.
3. To reset all the settings and cancel operation completely, press and hold ⓪ for 3 seconds.
 - ✓ The appliance stops any ongoing functions.

7.5 Filling the water tank

The water tank is located next to the cooking compartment. You will need to fill the water tank before starting any operation that uses steam.

⚠ WARNING – Risk of scalding!

Hot steam may escape when you open the appliance door. Steam may not be visible, depending on the temperature.

- ▶ When opening the door, do not stand too close to the appliance.
- ▶ Open the appliance door carefully.
- ▶ Keep children at a safe distance.

The water in the evaporator dish is still hot even after the appliance has been switched off.

- ▶ Never empty the evaporator dish immediately after switching off the appliance.
- ▶ Allow the appliance to cool down before cleaning.

When you open the appliance door, hot water may flow out of the appliance.

- ▶ When opening the door, do not stand too close to the appliance.
- ▶ Open the appliance door carefully.
- ▶ Keep children away from the appliance.
- ▶ If the evaporator dish overflows, do not pour more water into the water tank.

ATTENTION!

Using unsuitable liquids may damage the appliance.

- ▶ Do not use distilled water, highly chlorinated tap water (>40 mg/l) or other liquids.
- ▶ Only use cold, fresh tap water, softened water or non-carbonated mineral water.

Requirement: The water hardness range is set correctly. → Page 8

1. Open the appliance door.

2. Remove the water tank from the tank recess.

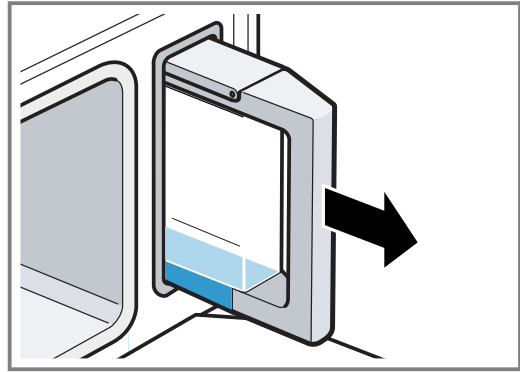

3. Fill the water tank with cold water up to the **max** mark.

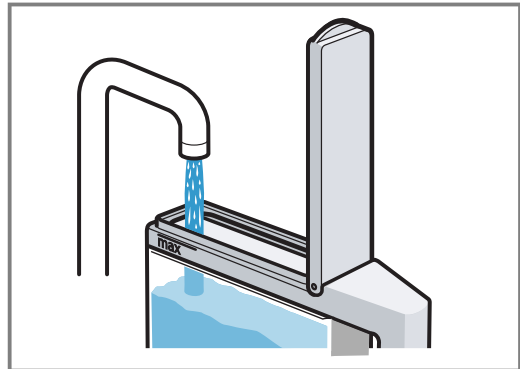

4. Close the tank lid.
5. Slot the full water tank back into the water tank recess.

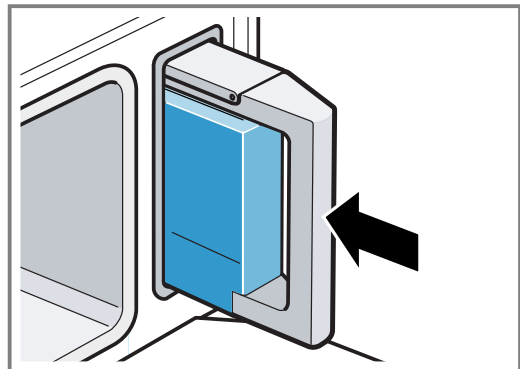

6. Check that the front end of the water tank is flush with the opening of the water tank recess.

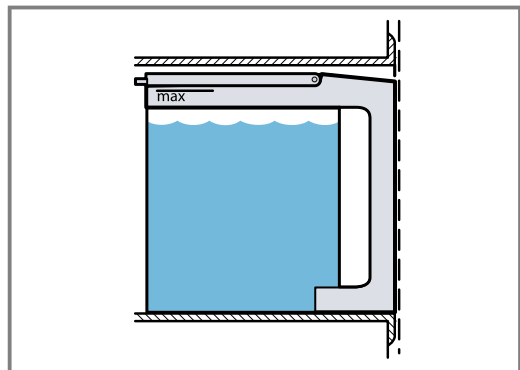

7. Close the appliance door.

7.6 Refilling the water tank

If the water tank runs dry during operation, steaming will be paused.

1. Open the appliance door carefully.
2. Remove the water tank from the tank recess.
3. Fill the water tank with water.
4. Slot the full water tank back into the water tank recess.
5. Close the appliance door.
6. Press \triangleright to resume operation.

7.7 Setting the heating function and temperature

When you switch on your appliance, the display will suggest a heating function and temperature. If you wish to use the suggested setting, you can start the appliance immediately by pressing \triangleright . If you wish to use a different setting, you will need to change the values.

Requirement: The water tank contains sufficient water.

1. Press \odot to switch the appliance on.
2. To select a heating function, press the symbol for that heating function on the control panel.
 - ✓ The temperature is highlighted on the display. [] will be lit on the control panel.
3. Use the control ring to set the required temperature.
4. Press \triangleright .
 - ✓ The appliance will now start.

7.8 "Fill water tank" message

If you select a heating function and the water tank is only half full, the appliance will display the message "Fill water tank".

If the water tank contains sufficient water for cooking, start the appliance.

If the water tank does not contain sufficient water for cooking, fill the water tank.

→ "Filling the water tank", Page 10

7.9 Changing the temperature

After the appliance is switched on, the temperature setting appears on the display.

- ▶ Turn the control ring to set a different temperature.
- ✓ The temperature is changed and applied immediately.

7.10 Changing heating functions

When you switch to a different heating function, the settings will also be reset.

1. To switch to a different heating function, press \triangleright to pause operation.
2. Select a new heating function.
3. The heating function and a temperature will appear on the display.

7.11 Cancelling operation

Note: You cannot abort the descaling process.

- ▶ Press and hold the \triangleright button until the appliance stops.
- ✓ The fan may continue to run after operation has been paused or stopped.

7.12 After using the Steam function

When you use the appliance, moisture and food remnants remain in the cooking compartment afterwards. Dry and clean the appliance after each use. Empty the water tank.

After using the Steam function

1. Dry the cooking compartment.
 - "Drying the cooking compartment", Page 17
2. Empty the water tank.
 - "Emptying the water tank", Page 17

8 Time-setting options

Your appliance has different time-setting options, with which you can control its operation.

8.1 Overview of the time-setting options

You can set a cooking time and an end time on the appliance. When you set a time on the timer, the timer will run independently of the appliance and will not intervene in its operation.

Time-setting option	Use
Timer	When you set a time on the timer, the timer will run independently of the appliance and will not intervene in its operation. It does not affect the appliance.

Time-setting option	Use
Cooking time []	If you set a cooking time, the appliance will stop heating automatically once this time has elapsed.
End time []	Along with the cooking time (duration), you can set the time at which you want cooking to end. The appliance will start up automatically so that it finishes cooking at the required time.





8.2 Setting the timer

The timer runs independently of the appliance and does not intervene in its operation. You can set the timer to times of up to 23 hours and 59 minutes, regardless of whether the appliance is on or off. The

timer has its own audible signal so that you can tell whether it is the timer or a cooking time that has elapsed.



Tip: If you want the appliance to switch itself off after a certain amount of time, use the cooking time.

Notes

- The timer duration always starts at 0 minutes.
 - As you scroll through the values to set the duration, they will increase by greater increments as they get higher.
1. Press .
 - ✓ The symbol will light up red.
 2. Use the control ring to set the timer duration.
 3. Press .
After a few seconds, the timer will start automatically.
 - ✓ The timer duration will then count down.
 - ✓ If you press  when the appliance is in operation, the timer duration will be displayed.
 - ✓ Once the set time has elapsed, an audible signal will sound.
 4. Press the  button to silence the audible signal before it is due to end.



Changing the timer

You can change the timer duration at any time.

1. Press .
2. Use the control ring to change the timer duration.
3. Press  to confirm.

Cancelling the timer



You can cancel the timer duration at any time.



1. Press .
2. Use the control ring to reset the timer duration to zero.
3. Press  to confirm.
- ✓ The red symbol will go out.

8.3 Setting the cooking time



Once the set cooking time has elapsed, the appliance switches off automatically. You can only use the cooking time in conjunction with a heating function. You can set a cooking time of up to 23 hours and 59 minutes.

Requirement: A heating function and a temperature must have been set.

1. Press .
- ✓ The symbol will light up red.
2. Use the control ring to set the cooking time.
The cooking time can be set in 1-minute increments up to 1 hour, and then in 5-minute increments. The end time is calculated automatically.
3. Press  to start.
- ✓ The appliance will now start heating. The cooking time will count down.
- ✓ Once the cooking time has elapsed, an audible signal will sound. The time shown on the display will be zero.
4. Once the cooking time has elapsed:
 - Press any touch key to silence the audible signal before it is due to end.
 - To set another cooking time, press  and use the control ring to set the cooking time.



- To continue without setting a cooking time, press .
- When the food is ready, press  to switch the appliance off.

Notes

- When you start the Steam function , the cooking time will not begin to count down until the set temperature has been reached.
- If you open the appliance door while the Steam function  is in progress, the appliance will stop. When you close the appliance door, the timer will not resume its countdown until the appliance has reached the set temperature again.



Changing the cooking time

You can change the cooking time at any time.

1. Press .
2. Use the control ring to change the cooking time.
3. Press  to confirm.

Cancelling the cooking time

You can cancel the cooking time at any time.

1. Press .
2. Use the control ring to reset the cooking time to zero.
3. Press  to confirm.
To continue without setting a cooking time, press .





8.4 Setting the end time

You can delay the time at which cooking is due to finish by up to 23 hours and 59 minutes.

Notes



- In order to achieve good cooking results, do not delay the end time once the appliance is already in operation.
- Food will spoil if you leave it in the cooking compartment for too long.

Requirement: The cooking time be set.

1. Press  again.
2. Use the control ring to delay the end time.
3. Use  to start the operation.
- ✓ The start time will appear on the display. The appliance is in standby mode.
- ✓ Once the start time has been reached, the appliance will start heating and the cooking time will start counting down.
- ✓ Once the cooking time has elapsed, an audible signal will sound. The time shown on the display will be zero.
4. Once the cooking time has elapsed:
 - To set cooking time again, press  and use the control ring to set the cooking time.
 - To continue without setting a cooking time, press .
 - When the food is ready, use  to switch the appliance off.

Changing the end time

In order to achieve good cooking results, only change the set end time before the appliance starts heating and before the cooking time starts counting down.

1. Press  to pause operation.
2. Press  twice.
3. Use the control ring to change the end time.

4. Press \triangleright to resume operation.

Cancelling the end time

You can delete the set end time at any time.

1. Press \triangleright to pause operation.

2. Press ⏏ twice.
 3. Use the control ring to change the end time.
 4. Press \triangleright to resume operation.
- ✓ The appliance will start heating again and the cooking time will count down.

9 Dishes

You can use "Dishes" mode to very easily cook food. The appliance will choose the optimal setting for you.

9.1 Setting a dish

Note: The cooking time depends on the dish. You cannot change the cooking time.

1. Press ⏏ .
 2. Use the control ring to select the appropriate dish.
 3. Press \triangleright to confirm the dish.
- ✓ The display shows which shelf position and which accessories or cookware to use.
4. Use \triangleright to start the operation.
- ✓ The appliance starts to heat and the time counts down.
 - ✓ The displayed cooking time may change during the first few minutes, as the heat-up time depends on the temperature of the ingredients and the water, amongst other things.
 - ✓ Once the set cooking time has elapsed, an audible signal sounds and the appliance stops heating.
5. Once the cooking time has elapsed:
 - Press ⏏ to end the audible signal early.
 - For some dishes, you can extend the cooking time if necessary.
→ "Extending the cooking time", Page 13
 - When the dish is ready, press ⏏ to switch the appliance off.

9.2 Setting a later end time

You can set a later end time for certain dishes.

Requirements

- A dish must have been selected.
 - Cooking must not yet be in progress.
1. Press ⏏ .
 2. Use the control ring to set the end time.
 3. Press \triangleright to start.
- ✓ The start time will appear on the display. The appliance is in standby mode.

9.5 Overview of the dishes

Follow the instructions for the dishes.

Dish	Weight/amount	Accessories/cookware	Shelf position
Steam cauliflower florets ^{1,2}	Florets of equal size	Perforated + unperforated steaming tray	2 + 1

¹ You can set an end time for this dish.

² Do not season vegetables until after cooking.

³ Do not place filets or other food items on top of each other.

- ✓ Once the start time has been reached, the appliance will start heating and the cooking time will start counting down.
- ✓ Once the cooking time has elapsed, an audible signal will sound. The time shown on the display will be zero.

Note: You cannot change the end time later on.

9.3 Extending the cooking time

For some dishes, the appliance allows you to extend the cooking time once the set cooking time has elapsed. You can do this as often as required.

1. If you do not want to extend the cooking time, press ⏏ and then use ⏏ to switch the appliance off.
 2. To extend the cooking time, press \triangleright .
- ✓ A cooking time appears on the display.
3. If necessary, use the control ring to change the cooking time.
4. Use \triangleright to start the operation.
- ✓ The appliance starts to heat and the time counts down.
 - ✓ Once the cooking time has elapsed, an audible signal sounds. The appliance stops heating. The notification for extending the cooking time appears again.
5. Once the cooking time has elapsed:
 - Press ⏏ to end the audible signal early.
 - If you want to extend the cooking time again, press \triangleright .
 - When the dish is ready, press ⏏ to switch the appliance off.

9.4 Cancelling settings

The settings cannot be changed once cooking is in progress.

- ▶ To delete all settings, press ⏏ to switch the appliance off.
- ✓ All settings are now deleted. You can configure new settings.

Dish	Weight/amount	Accessories/cookware	Shelf position
Steam broccoli florets ^{1,2}	Florets of equal size	Perforated + unperforated steaming tray	2 + 1
Steam green beans ^{1,2}	-	Perforated + unperforated steaming tray	2 + 1
Steam sliced carrots ^{1,2}	Slices approx. 3 mm thick	Perforated + unperforated steaming tray	2 + 1
Steam frozen mixed vegetables ²	-	Perforated + unperforated steaming tray	2 + 1
Unpeeled boiled potatoes ¹	Medium-sized, dia. 4 - 5 cm	Perforated + unperforated steaming tray	2 + 1
Basmati rice	Max. 0.75 kg	Unperforated steaming tray	2
Brown rice	Max. 0.75 kg	Unperforated steaming tray	2
Couscous	Max. 0.75 kg	Unperforated steaming tray	2
Lentils	Max. 0.55 kg	Unperforated steaming tray	2
Reheat cooked side dishes ¹		Unperforated steaming tray	2
Steam fresh chicken breast ³	Total weight 0.2 - 0.5 kg	Perforated + unperforated steaming tray	2 + 1
Steam fresh fish fillet ³	Max. 2.5 cm thick	Perforated + unperforated steaming tray	2 + 1
Steam whole fresh fish ³	0.3 - 2 kg	Perforated + unperforated steaming tray	2 + 1
Make yoghurt in jars	-	Jars + Unperforated steaming tray	2
Make rice pudding	-	Unperforated steaming tray	2
Make fruit compote ¹	-	Unperforated steaming tray	2
Sterilise bottles ¹		Unperforated steaming tray	2
Make soft-boiled eggs ¹	Medium eggs, max. 1 kg	Perforated + unperforated steaming tray	2 + 1
Make hard-boiled eggs ¹	Medium eggs, max. 1.8 kg	Perforated + unperforated steaming tray	2 + 1

¹ You can set an end time for this dish.

² Do not season vegetables until after cooking.

³ Do not place filets or other food items on top of each other.

9.6 Cooking instructions for dishes

Follow the instructions shown on your appliance. Proceed in accordance with this information when you are cooking dishes.

- All programs are designed for cooking on one level. Cooking times may vary depending on the quantity and quality of the ingredients.

Amount/weight

- When placing food into an accessory, ensure that it is piled no more than 4 cm high.
- Do not exceed the recommended maximum weight.

Accessories/cookware

- Use the cookware recommended in the overview.
- When cooking food in the perforated steaming tray, insert the unperforated steaming tray below it in position 1. This will catch any liquid that drips down.

Cereal products or lentils

Weigh the food and add the correct amount of water based on the ratios below:

- Basmati rice 1:1.5
- Couscous 1:1

- Brown rice 1:1.5
- Lentils 1:2
- Stir cereal products after cooking so that the remaining water is more quickly absorbed.

Fish

- Grease the perforated steaming tray.
- Do not place fish or fish fillets on top of each other.
- Select fish or fish fillets that are as similar in size as possible.
- Enter the weight of the heaviest fish.

Eggs

- Pierce eggs before cooking.
- Do not place eggs on top of each other.

Chicken breast

- Do not place chicken breasts on top of each other.

Vegetables

- Do not season vegetables until after cooking.

Making yoghurt

1. Heat the milk to 90 °C on the hob.

If you are using long-life milk, 40 °C is sufficient.

2. Allow the milk to cool to 40 °C.
3. Mix 150 g of chilled yoghurt into the milk.
4. Pour the mixture into cups or small jars and cover with cling film.
5. Place the cups or jars onto a steaming tray.
6. Observe the information in the overview and start the program. → Page 13
7. After making the yoghurt, leave it to cool in the refrigerator.

Making rice pudding

1. Weigh the rice.
 2. Add 2.5 times the amount of milk.
 3. Pour the rice and milk into the accessory until you have a mixture that is no more than 2.5 cm deep.
 4. Observe the information in the overview and start the program. → Page 13
 5. Stir the rice after cooking.
- ✓ The rice pudding will absorb the remaining milk.

Making fruit compote

The program is only suitable for fruits with stones and pips.

1. Weigh the fruit.
2. Add approx. 1/3 of the amount of water.
3. Add sugar and spices to taste.
4. Observe the information in the overview and start the program. → Page 13

Sterilising bottles

You can sterilise bottles in your appliance using the conventional sterilisation process.

1. Clean the bottles with the bottle brush immediately after use.
2. Clean the bottles in the dishwasher.
3. Place the bottles into the perforated steaming tray such that they do not touch one another.
4. Observe the information in the overview and start the program. → Page 13
5. Dry the bottles with a clean cloth.





10 Childproof lock

You can secure your appliance to prevent children from accidentally switching it on or changing the settings.

10.1 Activating and deactivating the childproof lock

You can activate and deactivate the childproof lock regardless of whether the appliance is switched on or off.

1. Press and hold  for approx. 4 seconds to activate the childproof lock.

- ✓ A confirmation notification will appear on the display.
 - ✓ The control panel is now locked. The appliance can only be switched off using the  button.
 - ✓ When the appliance is on,  will be lit. When the appliance is off,  will not be lit.
2. Press and hold  for approx. 4 seconds to deactivate the childproof lock.
- ✓ A confirmation notification will appear on the display.

11 Basic settings

You can configure the appliance to meet your needs.

11.1 Overview of the basic settings

Here you can find an overview of the basic settings and factory settings. The basic settings depend on the features of your appliance.

Notes

- Changes to the language, button tone and display brightness settings take effect immediately. All other settings do not take effect until you save them.
- Following a lengthy power failure, the settings that you will need to configure before you can use the appliance again will appear on the display. You will need to set the language, time and date again.

Setting	Selection
Language	Other languages available
Time	Time in 24-hour format
Date	Set the current date

¹ Factory setting (may vary according to model)

Setting	Selection
Water hardness	00 (softened) 01 (soft) 02 (moderately hard) 03 (hard) 04 (very hard)
Audible signal	Short (30 s) Medium (1 min) ¹ Long (5 min)
Button tone	Switched off ¹ (the button tone for the  button remains active even when the button tones are deactivated) Switched on
Display brightness	Can be adjusted to one of five different levels
Clock display	Digital ¹ Off

¹ Factory setting (may vary according to model)

Setting	Selection
Lighting	Switched on during operation ¹ Switched off during operation
Operating mode on start-up	Heating functions ¹ AutoPilot
Night-time dimming	Off ¹ On
Brand logo	Display ¹ Do not display
Fan run-on time	Recommended ¹ Minimum
Factory settings	Restore Do not restore ¹

¹ Factory setting (may vary according to model)

11.2 Changing the basic settings

Requirement: The appliance must be switched off.

1. Press and hold **i** for approx. 3 seconds.
 2. Press **☑** to confirm the notification on the display.
- ✓ The first basic setting will now be shown on the display.

3. Use the control ring to change the basic setting.
4. Press **☑**.
- ✓ The next basic setting will appear on the display.
5. Use the **☑** button to go through the basic settings, and make changes as required using the control ring.
6. Press and hold the **i** button for approx. 3 seconds to save your changes.

Discarding changes to the basic settings

- ▶ Press **⏪**.
- ✓ All your changes will be discarded and not saved.

11.3 Changing the time

You can change the time by going to the basic settings.

1. Press **⏪** to switch off the appliance.
2. Press and hold **i** for approx. 3 seconds.
3. Press **☑** to confirm the notification.
- ✓ The "Language" setting appears on the display.
4. Press **☑**.
- ✓ The "Time" setting appears on the display.
5. Use the control ring to change the time.
6. Press and hold **i** for approx. 3 seconds to confirm the time.

12 Cleaning and servicing

To keep your appliance working efficiently for a long time, it is important to clean and maintain it carefully.

12.1 Cleaning agents

Only use cleaning products that are suitable for the different surfaces on your appliance.

⚠ WARNING – Risk of electric shock!

An ingress of moisture can cause an electric shock.

- ▶ Do not use steam- or high-pressure cleaners to clean the appliance.

ATTENTION!

Unsuitable cleaning products may damage the surfaces of the appliance.

- ▶ Do not use harsh or abrasive detergents.
- ▶ Do not use oven cleaner.

- ▶ Do not use limescale remover on the door handle or control panel, as it may leave permanent staining.
- ▶ Do not use corrosive or harsh cleaning products or products containing chlorine.
- ▶ Salts are very corrosive and can cause rusting. Remove the remnants of any acidic sauces or salted food from the cooking compartment immediately once it has cooled.
- ▶ Do not use cleaning products with a high alcohol content.
- ▶ Do not use hard scouring pads or cleaning sponges.

Appliance front

Surface	Cleaning agent	Information
Aluminium	Soapy water Mild window-cleaning agent	After cleaning the surface, dry it with a soft cloth. Use a soft window cloth or a lint-free microfibre cloth to apply a mild window-cleaning agent to the appliance's aluminium front and wipe it horizontally across the surface without applying pressure.
Stainless steel	Soapy water Special stainless steel cleaner	After cleaning the surface, dry it with a soft cloth. To prevent corrosion, remove any patches of limescale, grease, starch or albumin (e.g. egg white) on stainless steel surfaces immediately.

Appliance interior

Cooking compartment with evaporator dish	Hot, soapy water Vinegar solution	Use the cleaning sponge provided or a soft washing-up brush to clean the cooking compartment and evaporator dish with hot, soapy water or a vinegar solution.
Accessories	Hot, soapy water Vinegar solution	Soak accessories in hot, soapy water and then clean with a brush or washing-up sponge. Alternatively, accessories can be cleaned in the dishwasher. If an accessory is exhibiting significant discolouration, clean it with a vinegar solution.
Water tank	Soapy water	Do not clean the water tank in the dishwasher.
Water tank recess		Wipe dry after every use.
Seal in the water tank lid		Wipe dry after every use.

Appliance door

Door panels	Glass cleaner	After cleaning the surface, dry it with a soft cloth.
Door seal	Hot, soapy water	

12.2 Microfibre cloth

The microfibre cloth removes liquids and grease. Order number 460 770 or from the online shop. This microfibre cloth has a honeycomb structure and is suitable for cleaning delicate surfaces such as the following:

- Glass
- Glass ceramics
- Stainless steel
- Aluminium

12.3 Cleaning sponge

Use the absorbent cleaning sponge only for cleaning the cooking compartment and for removing residual water from the evaporator dish.

Wash the cleaning sponge thoroughly before use.

You can wash the cleaning sponge in the washing machine using a hot wash program.

12.4 Drying the cooking compartment** WARNING – Risk of scalding!**

Hot steam may escape when you open the appliance door. Steam may not be visible, depending on the temperature.

- ▶ When opening the door, do not stand too close to the appliance.
- ▶ Open the appliance door carefully.
- ▶ Keep children at a safe distance.

The water in the evaporator dish is still hot even after the appliance has been switched off.

- ▶ Never empty the evaporator dish immediately after switching off the appliance.
- ▶ Allow the appliance to cool down before cleaning.

1. Leave the appliance door ajar until the appliance has cooled down.

2. Clean any food remnants from the cooking compartment.
3. Once it has cooled down, wipe down the cooking compartment and the evaporator dish with the cleaning sponge, and dry thoroughly with a soft cloth.
4. If condensation has formed on the front panels, dry them.

12.5 Emptying the water tank**ATTENTION!**

Drying the water tank in the hot cooking compartment leads to damage to the water tank.

- ▶ Do not dry the water tank in the hot cooking compartment.

Cleaning the water tank in the dishwasher will damage it.

- ▶ Do not clean the water tank in the dishwasher.
- ▶ Clean the water tank with a soft cloth and standard washing-up liquid.

1. Open the appliance door.
2. Remove the water tank and empty out the remaining water.
3. Dry the seal in the tank lid and the tank recess in the appliance.
4. Slot the water tank back into the water tank recess.
5. Close the appliance door.

12.6 Descaling

To ensure that your appliance continues to operate correctly, it must be descaled regularly. How often you need to descale your appliance depends on the hardness of the water used.

Notes

- Only use the liquid descaler recommended by us for descaling (order number 311 680).

- If you press  while the descaling process is in progress, the process will be stopped and the appliance will shut down. When you switch the appliance back on, you will need to rinse it twice in order to remove any remaining descaling solution. The appliance cannot be used for other applications until the second rinse cycle is complete.
- When you have five or fewer uses remaining for cooking with steam, your appliance will remind you to descale it.

Step	Duration
Descaling → <i>Page 18</i>	Approx. 30 min
First rinse cycle → <i>Page 18</i>	20 s
Second rinse cycle → <i>Page 18</i>	20 s

Starting the descaling process

It takes approx. 30 minutes to descale your appliance.



ATTENTION!

Using non-recommended descaler may damage the appliance

- ▶ Only use the liquid descaler recommended by us for the descaling programme. The time the descaler needs to be left to work depends on the product used.

If descaling solution comes into contact with the control panel or other delicate surfaces, it will damage them.

- ▶ Remove descaling solution immediately with water.

1. Mix 300 ml water with 60 ml liquid descaler to make a descaling solution.
2. Remove the water tank and pour the descaling solution into it.
3. Slide the water tank all the way into the appliance.
4. Close the appliance door.
5. Press .
6. Press .
7. Press  to start the descaling process.

Running the first rinse cycle

1. Remove the descaling solution from the evaporator dish using the cleaning sponge provided and then thoroughly rinse the cleaning sponge with water.
2. Remove the water tank and rinse thoroughly.
3. Fill the water tank with water and then slide it back into the appliance.
4. Close the appliance door.
5. Press .
- ✓ The appliance will rinse itself for approx. 20 seconds.
6. Open the appliance door.
7. Remove the remaining water from the evaporator dish using the cleaning sponge.
8. Proceed to the second rinse cycle. → *Page 18*

Running the second rinse cycle

1. Remove the water tank and rinse thoroughly.
2. Fill the water tank with water and then slide it back into the appliance.
3. Close the appliance door.
4. Press .
- ✓ The appliance will rinse itself for approx. 20 seconds.

5. Remove the remaining water from the evaporator dish using the cleaning sponge.
6. Wipe down the cooking compartment using the cleaning sponge and then dry with a soft cloth.
7. Switch off the appliance.
- ✓ The appliance is now ready for use again.

Descaling the evaporator dish

If necessary, you can descale the evaporator dish separately. To do this, you can either use your appliance's descaling function or you can descale the evaporator dish manually.

ATTENTION!

Using non-recommended descaler may damage the appliance

- ▶ Only use the liquid descaler recommended by us for the descaling programme. The time the descaler needs to be left to work depends on the product used.

If descaling solution comes into contact with the control panel or other delicate surfaces, it will damage them.

- ▶ Remove descaling solution immediately with water.

1. Mix 100 ml water with 20 ml liquid descaler to make a descaling solution.
2. Completely fill the evaporator dish with descaling solution.
3. Fill the water tank with water and then slide it all the way into the appliance.
4. Close the appliance door.
5. Start the descaling process. → *Page 18*

12.7 Appliance door

To clean or remove the door panels, you can detach the appliance door.

The appliance's door hinges each have a locking lever. When the locking levers are closed, the appliance door is secured in place. The appliance door cannot be removed when it is secured like this.

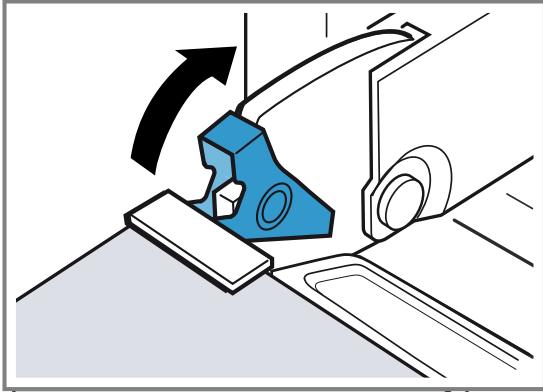

When the locking levers are open, the hinges are secured and cannot snap shut.

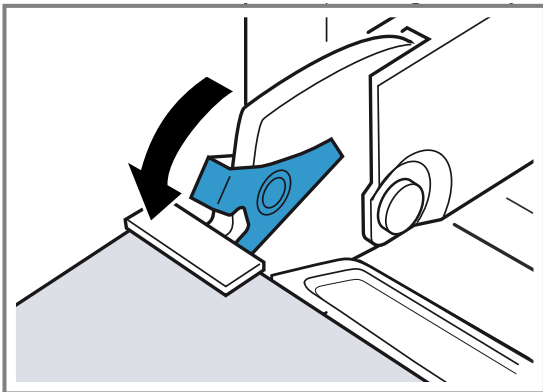

Detaching the appliance door

When the locking levers for detaching the appliance door are open, the hinges are secured and cannot snap shut.

⚠ WARNING – Risk of injury!

When the hinges are not secured, they can snap shut with great force.

- ▶ Make sure that the locking levers are always either fully closed or (when detaching the oven door) fully open.

The hinges on the appliance door move when the door is opened and closed, which could trap your fingers.

- ▶ Keep your hands away from the hinges.

1. Open the appliance door fully.

2. Open the left- and right-hand locking levers.

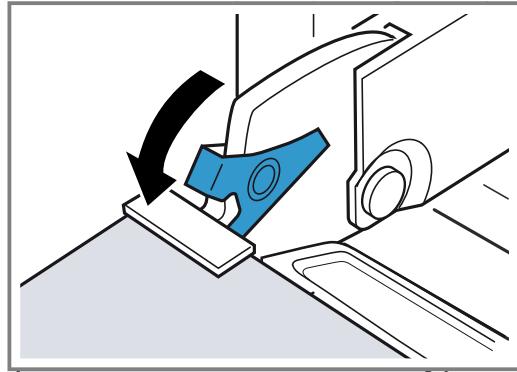

3. Partially close the appliance door such that it remains ajar at an angle of approx. 30°.
4. Take hold of the appliance door with both hands (one on each side) and pull it up and out.

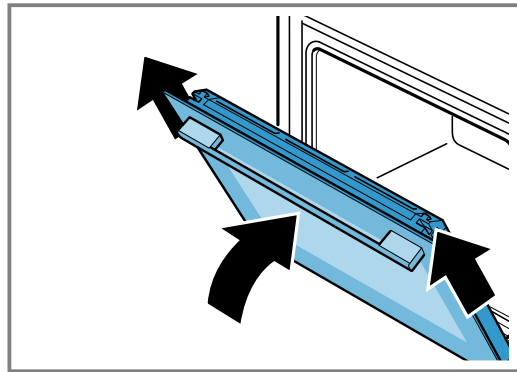

Reattaching the appliance door

When the locking levers are closed, the appliance door is secured in place and cannot be detached.

Note: Carry out the steps for detaching the appliance door in the reverse order.

→ "Detaching the appliance door", Page 19

1. Slide the appliance door down as far as it will go so that the hinges can be inserted straight into the opening.

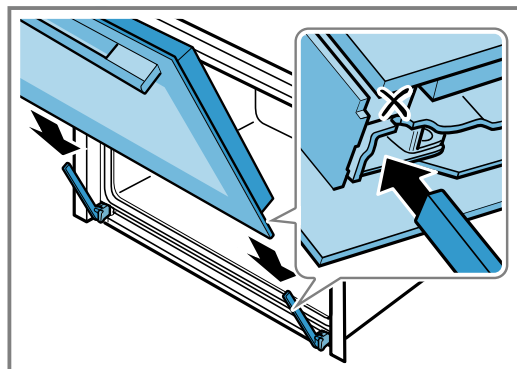

2. Open the appliance door fully.

3. Close the locking levers.

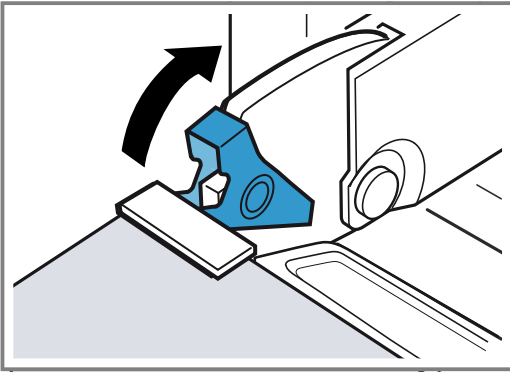

4. Close the appliance door.

12.8 Door panels

To make it easier to clean the door panels, you can remove the appliance door.

Removing the door panels

⚠ WARNING – Risk of injury!

The hinges on the appliance door move when the door is opened and closed, which could trap your fingers.

- ▶ Keep your hands away from the hinges.
- Components inside the appliance door may have sharp edges.
- ▶ Wear protective gloves.

1. Open the appliance door slightly.
2. Press on the left- and right-hand sides of the cover ①.
3. Remove the cover ②.

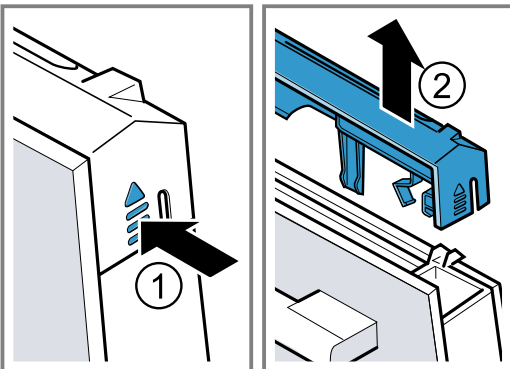

4. Lift out the inner panel upwards and set it down on a flat surface.

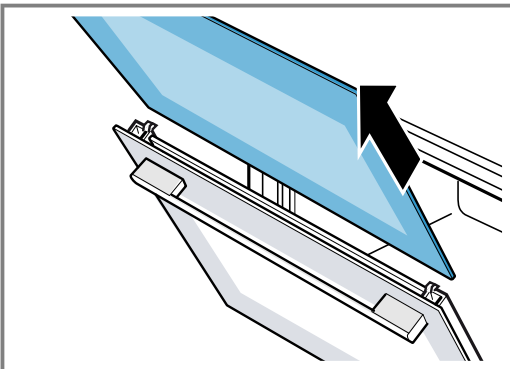

5. To remove and clean the condensate trough, if required, open the appliance door fully.

6. Tilt the condensate trough upwards and remove it.

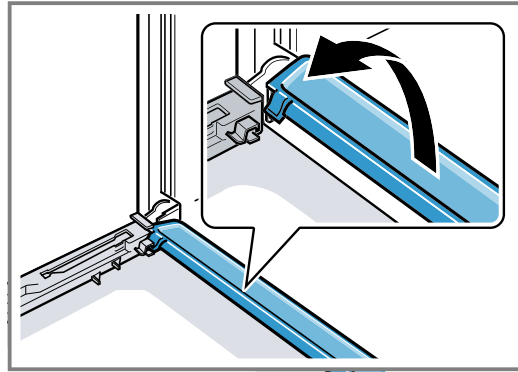

7. Clean the door panels with glass cleaner and a soft cloth. Clean the condensate trough with a cloth and hot soapy water.

Refitting the door panels

⚠ WARNING – Risk of injury!

The hinges on the appliance door move when the door is opened and closed, which could trap your fingers.

- ▶ Keep your hands away from the hinges.
- Components inside the appliance door may have sharp edges.
- ▶ Wear protective gloves.

Note: You cannot use your appliance again until the panels have been correctly fitted.

1. Open the appliance door fully.
2. Refit the condensation trough. To do this, insert the condensate trough from above and rotate it downwards **a**.

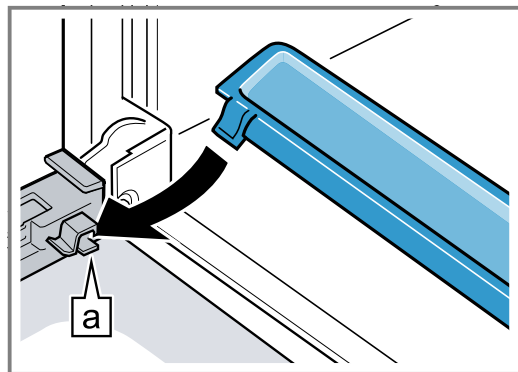

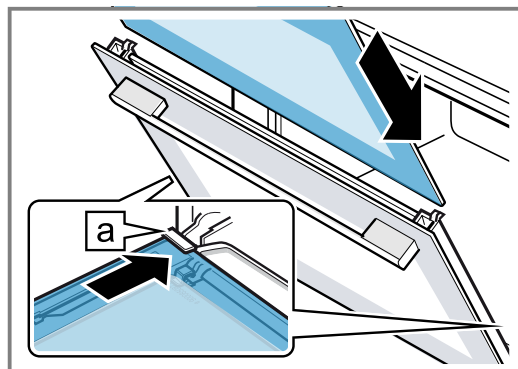

3. Slide in the inner panel **a**.

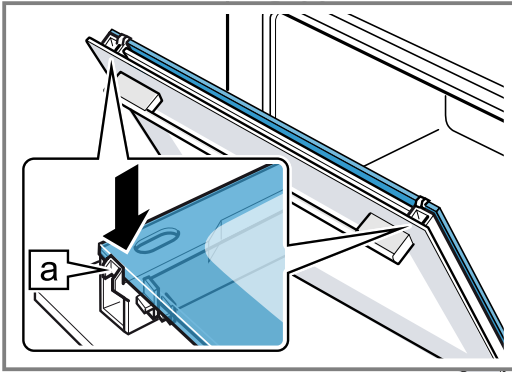

When doing this, ensure that the glossy side of the panel is on the outside and the cut-outs on the left and right are at the top. The panel must be sitting correctly at the bottom in the retainer.

4. Push the inner panel in at the top .



5. Put the cover back in place and press on it until you hear it click into place .

6. Open the appliance door fully.
7. Close the two locking levers on the left and right .

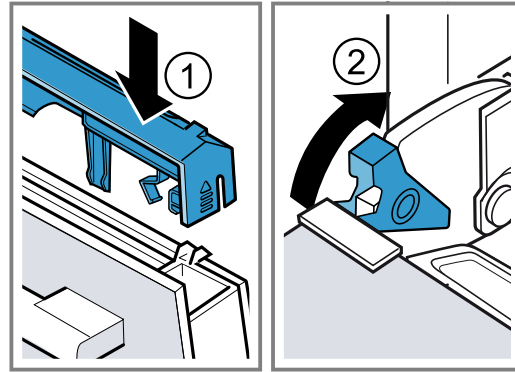

8. Close the appliance door.

13 Troubleshooting

You can rectify minor faults on your appliance yourself. Read the troubleshooting information before contacting after-sales service. This will avoid unnecessary costs.

WARNING – Risk of injury!

Improper repairs are dangerous.





- ▶ Repairs to the appliance should only be carried out by trained specialist staff.
- ▶ If the appliance is defective, call Customer Service.

WARNING – Risk of electric shock!

Incorrect repairs are dangerous.

- ▶ Repairs to the appliance should only be carried out by trained specialist staff.
- ▶ Only use genuine spare parts when repairing the appliance.
- ▶ If the power cord of this appliance is damaged, it must be replaced by trained specialist staff.

13.1 Malfunctions

Fault	Cause and troubleshooting
The appliance is not working.	<p>The circuit breaker is faulty.</p> <ul style="list-style-type: none"> ▶ Check the circuit breaker in the fuse box. <p>There has been a power cut.</p> <ul style="list-style-type: none"> ▶ Check whether the lighting in your kitchen or other appliances are working. <p>The mains plug of the power cord is not plugged in.</p> <ul style="list-style-type: none"> ▶ Connect the appliance to the power supply.
Appliance is switched on but controls not responding;  appears on the display.	<p>Childproof lock is activated.</p> <ul style="list-style-type: none"> ▶ Press and hold the  button until  goes out on the display.
Cooking compartment not heating, display showing  .	<p>Demo mode is activated.</p> <ol style="list-style-type: none"> 1. Briefly disconnect the appliance from the power supply by switching off the circuit breaker in the fuse box, waiting for approx. 10 seconds and then switching it back on again. 2. Go to the basic settings and deactivate Demo mode within the next 3 minutes. → "Basic settings", Page 15
A message with "D" or "E" appears in the display, e.g. D0111 or E0111.	<p>Malfunction</p> <ol style="list-style-type: none"> 1. Switch the appliance off and on again. ✓ If the fault was a one-off, the message disappears. 2. If the message appears again, call the after-sales service. Please specify the exact error message when calling.
Appliance will not start.	<p>Appliance door not fully closed.</p> <ul style="list-style-type: none"> ▶ Close appliance door. <p>Appliance not switched off.</p> <ul style="list-style-type: none"> ▶ Switch the appliance off and then on again.
"Language English" appears on the display.	<p>There has been a power cut.</p> <ul style="list-style-type: none"> ▶ Reset the language and the time.

Fault	Cause and troubleshooting
Cooking compartment not heating, display showing  symbol	Demo mode is activated. <ol style="list-style-type: none"> 1. Disconnect the appliance from the power supply by switching off the circuit breaker in the fuse box. 2. Go to the basic settings and deactivate Demo mode within the next 3 minutes.
Control ring has fallen out of mount on control panel.	Control ring has been disengaged. The control ring is detachable. <ol style="list-style-type: none"> 1. Place the control ring back into its mount on the control panel. 2. Push the control ring into the mount until it clicks into place and can be turned.
Control ring difficult to turn.	There is dirt under the control ring. Do not use harsh or abrasive cleaning products. Do not soak the control ring or its mount. Do not wash them in the dishwasher. <ol style="list-style-type: none"> 1. To disengage the control ring, lift it out of the mount. Alternatively, you can press on the edge of the control ring so that the control ring tilts and you can take hold of it. 2. Clean the control ring and its mount on the appliance using soapy water and a dish cloth. 3. Dry the control ring and its mount. 4. To ensure that the mount remains stable, do not remove the control ring too often.
Appliance prompting you to wipe down cooking compartment and fill water tank.	The power supply has been disconnected or the appliance has been switched off during the descaling process. <ul style="list-style-type: none"> ▶ When you switch the appliance back on, rinse it twice.
After an operating mode is switched on, a message on the display indicates that the temperature is too high.	Appliance has not cooled down sufficiently. <ol style="list-style-type: none"> 1. Allow the appliance to cool down. 2. Select an operating mode once again.
Appliance prompting you to descale it without counter appearing beforehand.	Water hardness range too low <ol style="list-style-type: none"> 1. Descale the appliance. 2. Check and adjust the set water hardness range.
Buttons are flashing.	Normal occurrence caused by condensation behind the control panel. No action required.
Liquid in evaporator dish completely evaporated even though water tank full.	Water tank not inserted correctly. <ul style="list-style-type: none"> ▶ Slide the water tank in until it clicks into place. Supply line to water tank blocked. <ol style="list-style-type: none"> 1. Descale the appliance. 2. Check and adjust the set water hardness range.
Water tank emptying for no reason and evaporator dish overflowing.	Water tank not closed properly. <ul style="list-style-type: none"> ▶ Close water tank lid and press down until it clicks into place. Tank lid seal dirty. <ul style="list-style-type: none"> ▶ Clean the seal. Tank lid seal defective. <ul style="list-style-type: none"> ▶ Buy a new water tank from our after-sales service.
Appliance prompting you to fill water tank even though water tank full.	Water tank not inserted correctly. <ul style="list-style-type: none"> ▶ Slide the water tank in until it clicks into place. Detection system not working. <ul style="list-style-type: none"> ▶ Call the after-sales service.
Appliance prompting you to fill water tank even though water tank not yet empty/appliance not prompting you to fill water tank even though water tank empty.	Water tank dirty and moving water level indicators jammed. <ol style="list-style-type: none"> 1. Shake and clean the water tank. 2. If the jammed parts cannot be freed, order a new water tank from our after-sales service.
A message that reads "Fill water tank?" appears on the display when the appliance is in operation.	Water tank half full. No action required.

Fault	Cause and troubleshooting
"Appliance heating up" appears on the display but the appliance is not reaching the selected temperature.	Automatic calibration values are not optimal. <ul style="list-style-type: none"> ▶ Restore the appliance's factory settings and repeat the procedure for initial configuration. <ul style="list-style-type: none"> → "Basic settings", Page 15 → "Before using for the first time", Page 8 ✓ The next time you use the Steam function at 100 °C, the calibration process will run automatically and more steam will be produced.
When cooking with steam, a lot of steam is produced.	The appliance is being automatically calibrated. No action required.
When cooking with steam, a lot of steam is produced and this happens repeatedly.	Appliance unable to calibrate itself automatically if cooking times too short. <ul style="list-style-type: none"> ▶ Restore the appliance's factory settings and repeat the calibration process.
Steam escaping from ventilation slots during cooking.	This is standard procedure. No action required.

13.2 Replacing the cooking compartment bulb

If the cooking compartment light has failed, replace the cooking compartment bulb.

Note: Heat-resistant, 25-watt, 230 V halogen bulbs are available from the after-sales service or specialist retailers. Only use these bulbs. Hold the new halogen bulbs only with a clean, dry towel. This increases the service life of the bulb.

⚠ WARNING – Risk of burns!

The appliance and its parts that can be touched become hot during use.

- ▶ Caution should be exercised here in order to avoid touching heating elements.
- ▶ Young children under 8 years of age must be kept away from the appliance.
- ▶ Never touch the ventilation openings.

⚠ WARNING – Risk of electric shock!

When changing the bulb, the bulb socket contacts are live.

- ▶ Before replacing the bulb, ensure that the appliance is switched off in order to prevent a potential electric shock.
- ▶ Also unplug the appliance from the mains or switch off the circuit breaker in the fuse box.

Requirements

- The appliance must be disconnected from the power supply.
- The cooking compartment must have cooled down.
- You must have a new halogen bulb to replace the old one.

1. Turn the glass cover anti-clockwise to remove it ①.

2. Pull out the halogen bulb without turning it ②.

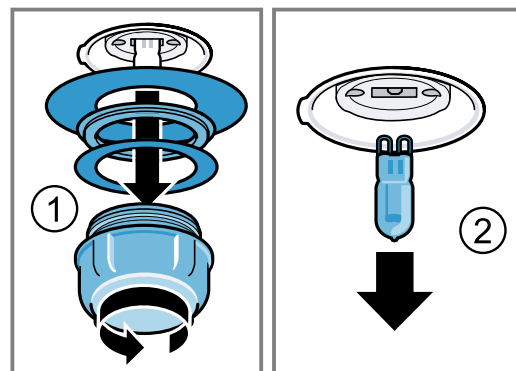

3. Insert the new halogen bulb and press it firmly into the socket. Make sure that the pins are positioned correctly.
4. Slide the new seals and the clamping ring onto the glass cover in the right order.
5. Screw the glass cover with the seals back on again. Never operate the appliance without the glass cover and seals.
6. Connect the appliance to the power supply and follow the initial configuration procedure again.

13.3 Replacing the glass cover or seals

If the halogen bulb's glass cover or seals are damaged, you must replace the damaged parts.

- ▶ Replace the glass cover or seals. You can obtain a new glass cover or new seals from our after-sales service.
 - "Customer Service", Page 33

13.4 Replacing the door seal

If the cooking compartment's outer door seal is defective, you must replace the door seal. Replacement seals for your appliance can be obtained from our after-sales service. Specify the E number and FD number of your appliance.

1. Open the appliance door.
2. Remove the old door seal.
3. Push the new door seal in on one side of the cooking compartment and then work it in all the way round. The joint must be at the side.

4. Check that the seal is correctly fitted, especially in the corners.

14 Disposal

Find out here how to dispose of old appliances correctly.

14.1 Disposing of old appliance

Valuable raw materials can be reused by recycling.

1. Unplug the appliance from the mains.
2. Cut through the power cord.
3. Dispose of the appliance in an environmentally friendly manner.
Information about current disposal methods are available from your specialist dealer or local authority.



This appliance is labelled in accordance with European Directive 2012/19/EU concerning used electrical and electronic appliances (waste electrical and electronic equipment - WEEE). The guideline determines the framework for the return and recycling of used appliances as applicable throughout the EU.

15 How it works

Here, you can find the ideal settings for various dishes as well as the best accessories and cookware. We have tailored these recommendations to your appliance.

15.1 What is the best way to proceed?

⚠ WARNING – Risk of scalding!

Hot steam may escape when you open the appliance door. Steam may not be visible, depending on the temperature.

- ▶ When opening the door, do not stand too close to the appliance.
- ▶ Open the appliance door carefully.
- ▶ Keep children at a safe distance.

Tip

If you are using the appliance for the first time, proceed in accordance with the following basic information:

- → "Safety", Page 2
- → "Saving energy", Page 4
- → "Condensation", Page 25

1. Select a suitable food type from the food overview.

Tips

- Your appliance has programmed settings for a selection of food types. If you want to be guided by the appliance, use the programmed dishes → Page 13.
 - If you do not find the exact food or application that you want to cook or use, look for a similar dish and use that as a reference.
2. Remove any accessories from the cooking compartment.
 3. Select suitable cookware and accessories.
Use the cookware and accessories listed in the recommended settings.
 4. Only preheat the appliance if the recipe or the recommended settings tell you to do so.
 5. Use the recommended settings when configuring the appliance settings.

6. When the dish is ready, press  to switch the appliance off.

15.2 Good to know

The tables below contain a selection of food that can be cooked in your appliance with excellent results. You can use these tables to find out which heating functions, accessories, temperature and cooking time to select. Unless otherwise stated, the information given assumes that the food will be placed in the appliance when the appliance is cold.

Accessories

Use the accessories provided.

When cooking food in the perforated steaming tray, always insert the unperforated steaming tray below it. The unperforated steaming tray will catch any liquid that drips down.

Cookware

When using cookware, always place it in the middle of the perforated steaming tray. Cookware must be heat- and steam-resistant. Food will take longer to cook if thick-sided cookware is used. When heating food in a bain marie (e.g. when melting chocolate), cover it with foil.

Cooking time and quantity

When steaming food, cooking times depend on the size of the individual pieces and not on the total quantity. The appliance can steam up to 2 kg of food at a time.

Use the individual piece sizes specified in the tables. Larger pieces will take longer to cook and smaller ones will cook more quickly. Cooking time is also influenced by the quality and age of the food. The values quoted can therefore only serve as a guideline.

Distributing food evenly

Always distribute the food evenly in the cookware. It will not cook evenly if the food is piled up to varying heights.

Food that is easily crushed

When placing delicate food that is easily crushed in the steaming tray, do not pile the individual pieces too high. It is better to use two steaming trays instead.

Cooking whole menus

With Steam functions, you can cook whole menus at once without the risk of flavours being transferred from one dish to another.

Place the food with the longest cooking time into the cooking compartment first. Add the rest of the food at the appropriate times. This means that all the food will be ready at the same time.

Cooking whole menus at once extends the total cooking time. This is because a little steam escapes when you open the appliance door and the cooking compartment must heat up again.











Condensation

Condensation can occur in the cooking compartment and on the appliance door when cooking. Condensation is normal and does not adversely affect appliance operation. Wipe away the condensation after cooking.













15.3 Vegetables

Place the vegetables into the perforated steaming tray and insert at position 2. Insert the unperforated steaming tray underneath at position 1. The unperforated steaming tray will catch any liquid that drips down.

Vegetables

Food	Piece size	Accessories/ cookware	Heating function	Temperature in °C	Cooking time in min
Artichokes	Whole	Perforated + unperforated steaming tray		100	20 - 35
Cauliflower	Whole	Perforated + unperforated steaming tray		100	25 - 35
Cauliflower	Florets	Perforated + unperforated steaming tray		100	10 - 15
Broccoli	Florets	Perforated + unperforated steaming tray		100	8 - 10
Peas	-	Perforated + unperforated steaming tray		100	5 - 10
Fennel	Sliced	Perforated + unperforated steaming tray		100	10 - 14
Vegetable flan	-	1.5 l bain-marie dish + perforated at shelf position 2		100	50 - 70
Green beans	-	Perforated + unperforated steaming tray		100	20 - 25
Carrots	Sliced	Perforated + unperforated steaming tray		100	10 - 20
Kohlrabi	Sliced	Perforated + unperforated steaming tray		100	20 - 25

¹ Preheat the appliance.

Food	Piece size	Accessories/ cookware	Heating function	Temperature in °C	Cooking time in min
Leek	Sliced	Perforated + unperforated steaming tray		100	6 - 9
Sweetcorn	Whole cob	Perforated + unperforated steaming tray		100	25 - 35
Chard ¹	Shredded	Perforated + unperforated steaming tray		100	8 - 10
Asparagus, green ¹	Whole	Perforated + unperforated steaming tray		100	7 - 12
Asparagus, white ¹	Whole	Perforated + unperforated steaming tray		100	10 - 15
Spinach ¹	-	Perforated + unperforated steaming tray		100	2 - 3
Romanesco	Florets	Perforated + unperforated steaming tray		100	8 - 10
Brussels sprouts	Sprouts	Perforated + unperforated steaming tray		100	20 - 30
Beetroot	Whole	Perforated + unperforated steaming tray		100	40 - 50
Red cabbage	Shredded	Perforated + unperforated steaming tray		100	30 - 35
White cabbage	Shredded	Perforated + unperforated steaming tray		100	25 - 35
Courgettes	Sliced	Perforated + unperforated steaming tray		100	3 - 4
Mangetouts	-	Perforated + unperforated steaming tray		100	8 - 12

¹ Preheat the appliance.

15.4 Side dishes and pulses

Recommended settings for cooking side dishes and pulses.













Cooking side dishes and pulses

1. Add the correct amount of water/liquid according to the specified ratio.

- For example: 1:1.5 = add 150 ml liquid for every 100 g rice.
2. Use the recommended settings when configuring the appliance settings.

Side dishes and pulses



Food	Ratio	Accessories/ cookware	Shelf position	Heating function	Temperature in °C	Cooking time in min
Unpeeled boiled potatoes (medium-sized)	-	Perforated + unperforated steaming tray	2 + 1		100	35 - 45

Food	Ratio	Accessories/ cookware	Shelf position	Heating func- tion	Temperature in °C	Cooking time in min
Peeled boiled potatoes	-	Perforated + unperforated steaming tray	2 + 1		100	20 - 25
Brown rice	1:1.5	Unperforated steaming tray	2		100	35 - 45
Long-grain rice	1:1.5	Unperforated steaming tray	2		100	20 - 30
Basmati rice	1:1.5	Unperforated steaming tray	2		100	20 - 30
Parboiled rice	1:1.5	Unperforated steaming tray	2		100	15 - 20
Risotto	1:2	Unperforated steaming tray	2		100	30 - 35
Lentils	1:2	Unperforated steaming tray	2		100	35 - 50
Cannellini beans, pre-softened	1:2	Unperforated steaming tray	2		100	65 - 75
Couscous	1:1	Unperforated steaming tray	2		100	6 - 10
Unripe spelt grain, coarsely ground	1:2.5	Unperforated steaming tray	2		100	15 - 20
Millet, whole	1:2.5	Unperforated steaming tray	2		100	25 - 35
Wheat, whole	1:1	Unperforated steaming tray	2		100	60 - 70
Dumplings	-	Perforated + unperforated steaming tray	2 + 1		100	20 - 25

15.5 Poultry and meat



Recommended settings for poultry and meat.

Poultry

Food	Amount	Accessories/ cookware	Shelf position	Heating func- tion	Temperature in °C	Cooking time in min
Chicken breast	0.15 kg each	Unperforated steaming tray	2		100	15 - 25
Duck breast ¹	0.35 kg each	Unperforated steaming tray	2		100	12 - 18



¹ Sear first and wrap in foil

Beef

Food	Amount	Accessories/ cookware	Shelf position	Heating func- tion	Temperature in °C	Cooking time in min
Thin piece of sirloin, medium ¹	1 kg	Unperforated steaming tray	2		100	25 - 35
Thick piece of sirloin, medium ¹	1 kg	Perforated + unperforated steaming tray	3 + 1		100	30 - 40



¹ Sear first and wrap in foil

Pork

Food	Amount	Accessories/ cookware	Shelf position	Heating func- tion	Temperature in °C	Cooking time in min
Fillet of pork	0.5 kg	Unperforated steaming tray	2		100	16 - 20
Pork medal- lions ¹	Approx. 3 cm thick	Unperforated steaming tray	2		100	10 - 12
Smoked pork ribs	Sliced		2		100	15 - 20

¹ Sear first and wrap in foil





Sausages





Food	Accessories/ cookware	Shelf position	Heating function	Temperature in °C	Cooking time in min
Wiener sausages	Perforated + un- perforated steam- ing tray	2 + 1		80 - 90	12 - 18
Bavarian veal sausages	Perforated + un- perforated steam- ing tray	2 + 1		80 - 90	20 - 25

15.6 Fish





Recommended settings for cooking fish and mussels.

Fish

Food	Amount	Accessories/ cookware	Shelf position	Heating func- tion	Temperature in °C	Cooking time in min
Sea bream, whole	0.3 kg each	Perforated + unperforated steaming tray	2 + 1		80 - 90	15 - 25
Sea bream fil- let	0.15 kg each	Perforated + unperforated steaming tray	2 + 1		80 - 90	10 - 20
Fish terrine	1.5 l bain- marie dish	Unperforated steaming tray	2		70 - 80	40 - 80
Trout, whole	0.2 kg each	Perforated + unperforated steaming tray	2 + 1		80 - 90	12 - 15
Cod fillet	0.15 kg each	Perforated + unperforated steaming tray	2 + 1		80 - 90	10 - 14

Food	Amount	Accessories/ cookware	Shelf position	Heating func- tion	Temperature in °C	Cooking time in min
Salmon fillet	0.15 kg each	Perforated + unperforated steaming tray	2 + 1		100	8 - 10
Mussels	1.5 kg	Unperforated steaming tray	2		100	10 - 15
Ocean perch fillet	0.15 kg each	Perforated + unperforated steaming tray	2 + 1		80 - 90	10 - 20
Sole rolls, stuffed		Perforated + unperforated steaming tray	2 + 1		80 - 90	10 - 20

15.7 Soup garnishes, miscellaneous

Food	Accessories/ cookware	Shelf position	Heating function	Temperature in °C	Cooking time in min
Royale	Unperforated steaming tray	2		90	15 - 20
Semolina dump- lings	Perforated + un- perforated steam- ing tray	2 + 1		90 - 95	7 - 10
Hard-boiled eggs (size M, max. 1.8 kg)	Perforated + un- perforated steam- ing tray	2 + 1		100	10 - 12
Soft-boiled eggs (size M, max. 1 kg)	Perforated + un- perforated steam- ing tray	2 + 1		100	6 - 8

15.8 Desserts, compote

Recommended settings for making desserts and compote.

Making compote

1. Weigh the fruit.
2. Add approx. 1/3 of the amount of water.
3. Add sugar and spices to taste.
4. Use the recommended settings when configuring the appliance settings.

Making rice pudding

1. Weigh the rice.
2. Add 2.5 times the amount of milk.
3. Pour the rice and milk into a bowl until you have a mixture that is no more than 2.5 cm deep.
4. Use the recommended settings when configuring the appliance settings.

5. Stir the rice pudding after cooking.
- ✓ The rice pudding will absorb the remaining milk.









Making yoghurt

1. Heat the milk to 90 °C on the hob. Then leave to cool to 40 °C.
If you are using long-life milk, heat the milk to 40 °C. This temperature is sufficient for long-life milk.
2. Mix 150 g of (chilled) yoghurt into the milk.
3. Pour the mixture into cups or small jars and cover with cling film.
4. Slide the perforated steaming tray into the cooking compartment.
5. Place the cups or jars into the perforated steaming tray.
6. Use the recommended settings when configuring the appliance settings.
7. After making the yoghurt, leave it to cool in the refrigerator.

Desserts, compote

Food	Accessories/cook- ware	Heating function	Temperature in °C	Cooking time in min
Yeast dumplings	Unperforated steam- ing tray		100	20 - 25

¹ You can also use the appropriate dish.
→ "Dishes", Page 13

Food	Accessories/cook-ware	Heating function	Temperature in °C	Cooking time in min
Crème caramel	Ramekins + perforated steaming tray		80	15 - 20
Rice pudding ¹	Unperforated steaming tray		100	25 - 35
Yoghurt ¹	Glass jars + perforated steaming tray		40	300 - 360
Apple compote	Unperforated steaming tray		100	10 - 15
Pear compote	Unperforated steaming tray		100	10 - 15
Cherry compote	Unperforated steaming tray		100	10 - 15
Rhubarb compote	Unperforated steaming tray		100	10 - 15
Plum compote	Unperforated steaming tray		100	15 - 20



¹ You can also use the appropriate dish.
→ "Dishes", Page 13

15.9 Reheating

Reheating cold food gently warms the food without impairing its quality. The food tastes and looks as though it has been freshly prepared.

Reheating

Reheating dishes gently rewarms the food without impairing its quality. It tastes and looks as though it has been freshly prepared.

Food	Accessories/cookware	Shelf position	Heating function	Temperature in °C	Cooking time in min
Vegetables	Unperforated steaming tray	2		100	12 - 15
Pasta, potatoes, rice	Unperforated steaming tray	2		100	5 - 25

15.10 Defrosting

The "Defrost" steam function is suitable for defrosting frozen fruit and vegetables.

It is best to defrost meat and fish in the refrigerator. If you want to retain liquid in the frozen food, e.g. frozen creamed spinach, use the unperforated steaming tray.

Notes



- The times specified in the table are given as a guide only and depend on the quality, freezing temperature (-18 °C) and consistency of the food. The table specifies time ranges. Set the shortest cooking time to begin with, and then extend the time if necessary.

- Food that is frozen in thin pieces or individual portions defrosts more quickly than food that is frozen in a block.

Defrosting frozen food

1. Remove the frozen food from its packaging.
2. Place the frozen food into the perforated steaming tray.
3. Insert the perforated steaming tray into the cooking compartment and insert the unperforated steaming tray below it.
- ✓ This way, the food does not sit in the water that accumulates as it defrosts, and any liquid that drips down remains in the unperforated steaming tray.
4. Use the recommended settings when configuring the appliance settings.

Defrosting

Food	Amount	Accessories/ cookware	Shelf position	Heating func- tion	Temperature in °C	Cooking time in min
Berries	0.5 kg	Perforated + unperforated steaming tray	2 + 1		50 - 55	15 - 20
Vegetables	0.5 kg	Perforated + unperforated steaming tray	2 + 1		40 - 50	15 - 50

15.11 Extracting juice



Recommended settings for juicing berries.

Juicing berries

1. Place the berries in a bowl and sprinkle with sugar.
2. Leave the mixture to stand for at least 1 hour to draw out the juice from the berries.

3. Pour the berries into the perforated steaming tray and insert at position 2.
4. Insert the unperforated steaming tray one level below to catch the juice.
5. Use the recommended settings when configuring the appliance settings.
6. Once the cooking time has elapsed, wrap the berries in a cloth and squeeze out the remaining juice.
7. Dry the cooking compartment.

Extracting juice

Food	Accessories/ cookware	Shelf position	Heating function	Temperature in °C	Cooking time in min
Raspberries	Perforated + un- perforated steam- ing tray	2 + 1		100	30 - 45
Currants	Perforated + un- perforated steam- ing tray	2 + 1		100	40 - 50

15.12 Preserving

Preserve fruit and vegetables by heating them and sealing them in air-tight jars.

- Preserve food when it is fresh. When foods are stored for a relatively long period, their vitamin content is reduced and they ferment and spoil more easily.
- Only use fruit and vegetables that are in perfect condition.
- You cannot preserve the following food in your appliance: The contents of tin cans, meat, fish or pie filling.
- Check preserving jars, rubber rings, clips and springs.



Preserving fruit and vegetables

Requirement: Check preserving jars, rubber rings, clips and springs.

1. Clean rubber rings and jars thoroughly with hot water.
You can use the appliance to sterilise the jars.
→ Page 15
2. Slide the perforated steaming tray into the cooking compartment.
3. Place the prepared jars into the perforated steaming tray.
The jars must not be in contact with each other.
4. After the specified cooking time, open the appliance door.
5. Do not remove the preserving jars from the appliance until they have completely cooled down.

Preserving

Recommended settings for preserving with steam.

Food	Accessories/ cookware	Shelf position	Heating function	Temperature in °C	Cooking time in min
Vegetables	1-litre preserving jars	2		100	30 - 120
Fruit with stones	1-litre preserving jars	2		100	25 - 30
Fruit with pips	1-litre preserving jars	2		100	25 - 30

15.13 Dough proving

Recommended settings for proving dough. You can prove yeast dough more quickly in your appliance than at room temperature.

Dough proving

1. Insert the perforated steaming tray into the cooking compartment.

- You may use whichever shelf position you like for the perforated steaming tray.
2. Place the mixing bowl with the dough into the perforated steaming tray. Do not cover the dough.
 3. Use the recommended settings when configuring the appliance settings.











Yeast dough

Food	Accessories/ cookware	Shelf position	Heating function	Temperature in °C	Cooking time in min
Yeast dough	1 kg	Bowl + perforated steaming tray		35	20 - 30

15.14 Frozen products

Follow the manufacturer's instructions on the packaging. The cooking times indicated assume that the food will be placed in the appliance when the cooking compartment is cold.

Defrosting and warming up frozen food



Food	Accessories/ cookware	Shelf position	Heating function	Temperature in °C	Cooking time in min
Pasta, fresh, refrigerated ¹	Unperforated steaming tray	2		100	5 - 10
Trout	Perforated + unperforated steaming tray	2 + 1		80 - 100	20 - 25
Salmon fillet	Perforated + unperforated steaming tray	2 + 1		80 - 100	20 - 25
Broccoli	Perforated + unperforated steaming tray	2 + 1		100	6 - 10
Cauliflower	Perforated + unperforated steaming tray	2 + 1		100	5 - 8
Beans	Perforated + unperforated steaming tray	2 + 1		100	6 - 10
Peas	Perforated + unperforated steaming tray	2 + 1		100	5 - 12
Carrots	Perforated + unperforated steaming tray	2 + 1		100	4 - 6
Mixed vegetables	Perforated + unperforated steaming tray	2 + 1		100	6 - 10
Brussels sprouts	Perforated + unperforated steaming tray	2 + 1		100	5 - 10

¹ Add a little water to the food.

15.15 Test dishes

These overviews have been produced for test institutes to facilitate appliance testing in accordance with EN 60350-1:2013 or IEC 60350-1:2011 and EN 60705:2012, IEC 60705:2010.

Recommended settings for test dishes

Food	Accessory	Height	Type of heating	Temperature in °C	Cooking time in min.
Broccoli (steam distribution)	Perforated + un-perforated	2 + 1		100	7-9
Broccoli (steam supply)	Perforated + un-perforated	2 + 1		100	7-9
Peas (maximum load) ¹	Perforated + un-perforated	2 + 1		100	5-12

¹ Spread out 2.0 kg peas evenly in the container.

16 Customer Service

If you have any queries on use, are unable to rectify faults on the appliance yourself or if your appliance needs to be repaired, contact Customer Service. Function-relevant genuine spare parts according to the corresponding Ecodesign Order can be obtained from Customer Service for a period of at least 10 years from the date on which your appliance was placed on the market within the European Economic Area.

Note: Under the terms of the manufacturer's warranty the use of Customer Service is free of charge.

Detailed information on the warranty period and terms of warranty in your country is available from our after-sales service, your retailer or on our website.

If you contact Customer Service, you will require the product number (E-Nr.) and the production number (FD) of your appliance.

The contact details for Customer Service can be found in the enclosed Customer Service directory or on our website.

16.1 Product number (E-Nr.) and production number (FD)

You can find the product number (E-Nr.) and the production number (FD) on the appliance's rating plate. You will see the rating plate with these numbers if you open the appliance door.

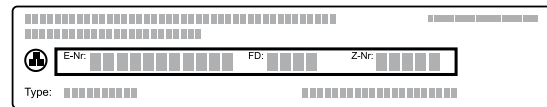

Make a note of your appliance's details and the Customer Service telephone number to find them again quickly.

17 Installation instructions

Observe this information when installing the appliance.



17.1 General installation instructions

Follow these instructions before you start with the installation of the appliance.

- The safe operation of this appliance can only be guaranteed if it has been installed to a professional standard in accordance with these installation instructions. The installer shall be liable for damages incurred as a result of incorrect installation.
- Check the appliance for damage after unpacking it. Do not connect the appliance if it has been damaged in transit.
- Before starting up the appliance, remove any packaging material and adhesive film from the cooking compartment and the door.
- Proceed in accordance with the installation sheets for installing accessories.
- Fitted units must be heat-resistant up to 95 °C, and adjacent unit fronts up to 70 °C.

- Do not install the appliance behind a decorative door or the door of a kitchen unit. There is a risk of overheating.
 - Cut-out work on the units should be carried out before installing the appliance. Remove any shavings. Otherwise, the correct operation of electrical components may be adversely affected.
 - The mains socket for the appliance must either be located in the hatched area **a** or outside of the area where the appliance is installed.
- Any unsecured units must be secured to the wall using a standard bracket **b**.

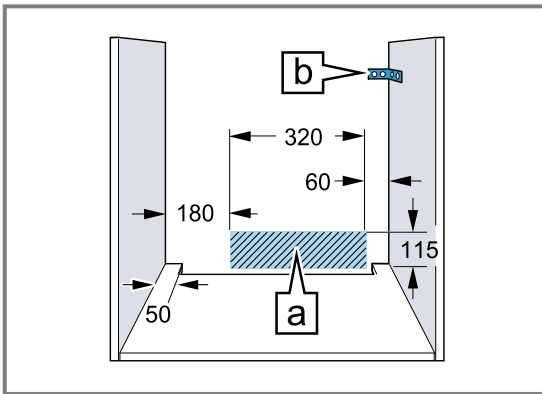

- Wear protective gloves so that you do not cut yourself. Parts that are accessible during installation may have sharp edges.
- Dimensions of the figures in mm.

⚠ WARNING – Danger: Magnetism!

Permanent magnets are used in the control panel or in the controls. They may affect electronic implants, e.g. pacemakers or insulin pumps.

- ▶ Wearers of electronic implants must stay at least 10 cm away from the control panel or controls during the installation.

⚠ WARNING – Risk of fire!

It is dangerous to use an extended power cord and non-approved adapters.

- ▶ Do not use extension cables or multiple socket strips.

- ▶ If the power cord is too short, contact Customer Service.
- ▶ Only use adapters approved by the manufacturer.

ATTENTION!

Carrying the appliance by the door handle could break it. The door handle cannot support the weight of the appliance.

- ▶ Do not carry or hold the appliance by the door handle.

17.2 Appliance dimensions

You will find the dimensions of the appliance here

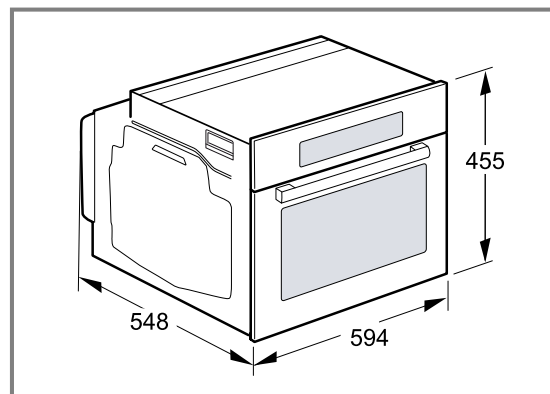

17.3 Installation below a worktop

Observe the installation dimensions and the installation instructions when installing below a worktop.

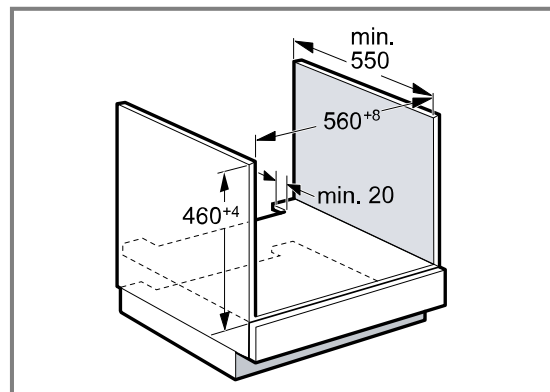

- To ventilate the appliance, the intermediate floor must have a ventilation cut-out.
- The worktop must be secured to the built-in unit.
- Observe any available installation instructions for the hob.

17.4 Installation underneath a hob

If the appliance is installed under a hob, the following minimum dimensions must be adhered to (including substructure, if applicable).

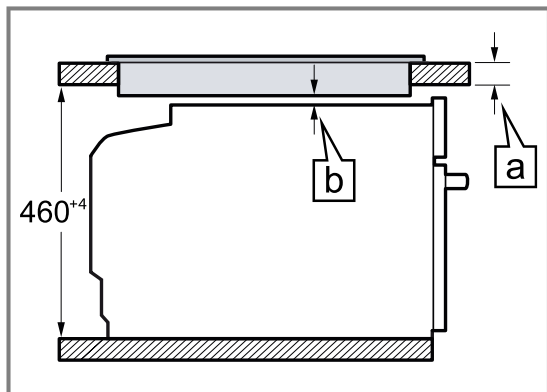

The minimum worktop thickness \boxed{a} is based on the required minimum clearance \boxed{a} .

Hob type	a raised in mm	a flush in mm	b in mm
Induction hob	42	43	5
Full-surface induction hob	52	53	5
Gas hob	32	43	5
Electric hob	32	35	2

17.5 Installation in a tall unit

Observe the installation dimensions and the installation instructions when installing in a tall unit.

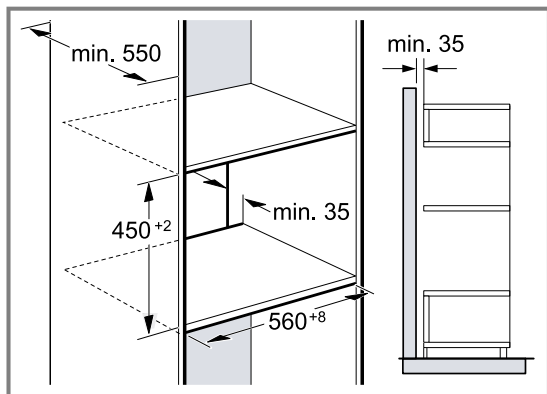

- To ventilate the appliance, the intermediate floors must have a ventilation cut-out.
- If the tall unit has another back panel in addition to the element back panels, this must be removed.
- Only fit the appliance up to a height which allows accessories to be easily removed.

17.6 Corner installation

Observe the installation dimensions and the installation instructions when installing in a corner.

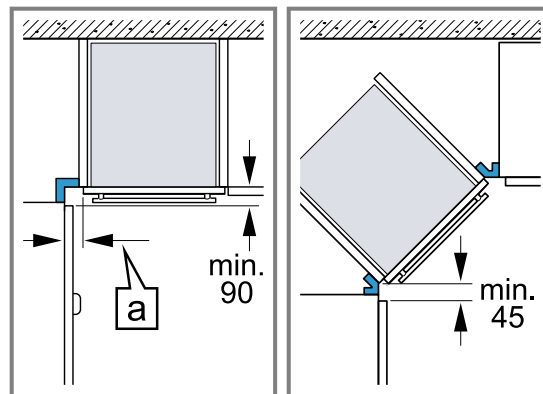

- To ensure that the appliance door can be opened, you must take the minimum dimensions into consideration when installing in a corner. The dimension \boxed{a} is dependent on the thickness of the unit front and the handle.

17.7 Electrical connection

In order to safely connect the appliance to the electrical system, follow these instructions.

- The appliance corresponds to protection class I and must only be operated with a protective earth connection.
- The fuse protection must correspond to the power rating specified on the appliance's rating plate and to local regulations.
- The appliance must be disconnected from the power supply whenever installation work is being carried out.

- The appliance must only be connected using the power cable provided.
- The power cable must be plugged in at the rear of the appliance until you hear a clicking sound. A 3 m power cable can be obtained from the after-sales service.
- The power cable must only be replaced with a cable from the original manufacturer. This is available from after-sales service.
- Contact protection must be ensured during the installation.

Electrically connect the appliance with the protective contact plug

Note: The appliance must only be connected to a protective contact socket that has been correctly installed.

- ▶ Insert the plug into the protective contact socket. When the appliance is installed, the mains plug of the power cord must be freely accessible. If free access to the mains plug is impossible, an all-pole isolating switch must be integrated into the permanent electrical installation in accordance with the installation regulations.

Electrically connecting an appliance without a protective contact plug

Note: Only a licensed professional may connect the appliance. Damage caused by incorrect connection is not covered under the warranty.

An all-pole isolating switch must be integrated into the permanent electrical installation according to the installation regulations.

1. Identify the phase and neutral conductors in the socket.
The appliance may be damaged if it is not connected correctly.
2. Connect the hob in accordance with the connection diagram.
See the rating plate for the voltage.
3. Connect the wires of the mains power cable according to the colour coding:
 - Green/yellow = Protective conductor ⊕
 - Blue = Neutral conductor
 - Brown = Phase (external conductor)

17.8 Installing the appliance

1. Slide the appliance all the way in and centre it.

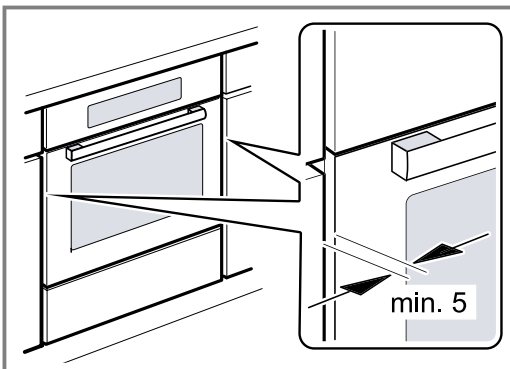

2. Screw the appliance into place.

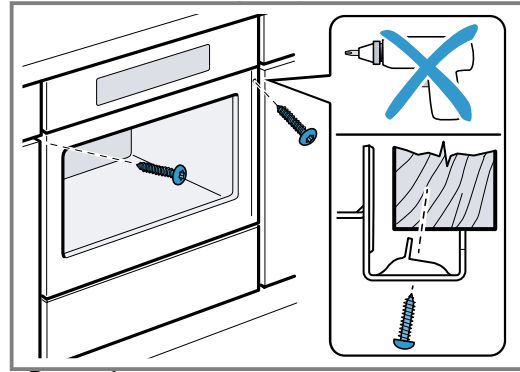

Note: The gap between the worktop and the appliance must not be closed by additional battens. Thermal insulation strips must not be fitted to the side panels of the surround unit.

17.9 Removing the appliance

1. Disconnect the appliance from the power supply.
2. Undo the fastening screws.
3. Lift the appliance slightly and pull it out completely.



A series of horizontal lines for writing, starting from the top of the page and extending downwards.



A series of horizontal lines for writing, consisting of approximately 30 evenly spaced lines.



Thank you for buying a Bosch Home Appliance!

Register your new device on MyBosch now and profit directly from:

- **Expert tips & tricks for your appliance**
- **Warranty extension options**
- **Discounts for accessories & spare-parts**
- **Digital manual and all appliance data at hand**
- **Easy access to Bosch Home Appliances Service**

Free and easy registration – also on mobile phones:

www.bosch-home.com/welcome

BOSCH
HOME APPLIANCES
SERVICE

Looking for help? You'll find it here.

Expert advice for your Bosch home appliances, help with problems or a repair from Bosch experts.

Find out everything about the many ways Bosch can support you:

www.bosch-home.com/service

Contact data of all countries are listed in the attached service directory.

Robert Bosch Hausgeräte GmbH

Carl-Wery-Straße 34
81739 München
GERMANY
www.bosch-home.com



9001589571 (010506)

en

Valid within Great Britain:
Imported to Great Britain by
BSH Home Appliances Ltd.
Grand Union House
Old Wolverton Road
Wolverton, Milton Keynes
MK12 5PT
United Kingdom