



de Montageanleitung
en Installation instructions
fr Notice de montage
nl Montagevoorschrift
it Istruzioni per il montaggio
el Οδηγίες τοποθέτησης
es Instrucciones de montaje
pt Instruções de montagem
sv Monteringsanvisning
no Monteringsanvisning
fi Asennusohje
da Monteringsvejledning
tr Montaj kılavuzu

ru Инструкция по монтажу
cs Montážní návod
pl Instrukcja montażu
hu Szerelési utasítás
hr Uputa za montažu
mk Упатство за монтажа
sl Navodilo za montažo
sr Uputstvo za montažu
et Monteerimisjuhend
lt Montavimo instrukcija
lv Montāžas pamācība
sk Návod na montáž
sq Udhëzues për montim

bs Uputa za montažu
fa راهنمایی مونتاژ
ar تعليمات التركيب
ko 설치 설명서
zh 安装说明
uk Інструкція з монтажу
ro Instrucțiunea de montaj
bg Упътване за монтаж
ja インストールに関する指示
he הוראות התקנה
id Instruksi Pemasangan
kk Іске қосу туралы нұсқаулар

de *) über Kundendienst erhältlich
en *) Available from customer service
fr *) Disponible par le biais du service après-vente
nl *) Tegen meerprijs bij de Servicedienst verkrijgbaar
it *) Disponibili presso il servizio assistenza clienti
el *) Διατίθενται από την υπηρεσία τεχνικής εξυπηρέτησης πελατών
es *) Se puede adquirir a través del Servicio de Asistencia Técnica Oficial de la marca
pt *) Pode ser adquirido nos nossos Serviços Técnicos
sv *) kan fås via Service
no *) fåes hos kundeservice
fi *) Saatavissa huoltopalvelusta
da *) Kan købes hos serviceafdelingen
tr *) Yetkili servis üzerinden alınabilir
ru *) Можно получить в сервисном центре
cs *) K dispozici přes servisní službu
pl *) Do uzyskania w punkcie serwisowym
hu *) A vevőszolgálaton keresztül kapható
hr *) može dobiti kod službe održavanja
mk *) се добива преку службата за купувачи

sl *) Lahko nabavite v servisni službi
sr *) Može se nabaviti preko servisne službe
et *) küsige klienditeeninduselt
lt *) Ją galima gauti klientų aptarnavimo servise
lv *) Var saņemt servisa dienestā
sk *) Dostanete v službe zákazníkovi
sq *) Sigurohet nëpërmjet servisit
bs *) Može se dobiti preko servisne službe
fa *) از مرکز خدمات پس از فروش تهیه فرمائید
ar *) يمكن طلبها من مراكز خدمة العملاء
ko *) 고객센터 서비스 센터에서 구입 가능
zh *) 可通过售后服务部门购得
uk *) Можна отримати через сервісну службу
ro *) Se obține de la serviciul pentru clienți
bg *) може да се намери в специализираните сервиси
ja *) 顧客サービスから利用可能
he *) להשיג בתחנת שירות הלקוחות
id *) bisa didapatkan melalui Customer Service
kk *) Сервис қызмет көрсету орталығында алуына жатады



Ø4X36

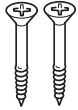

Ø4X15

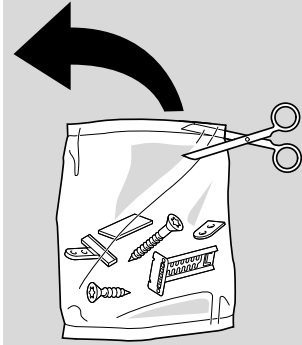
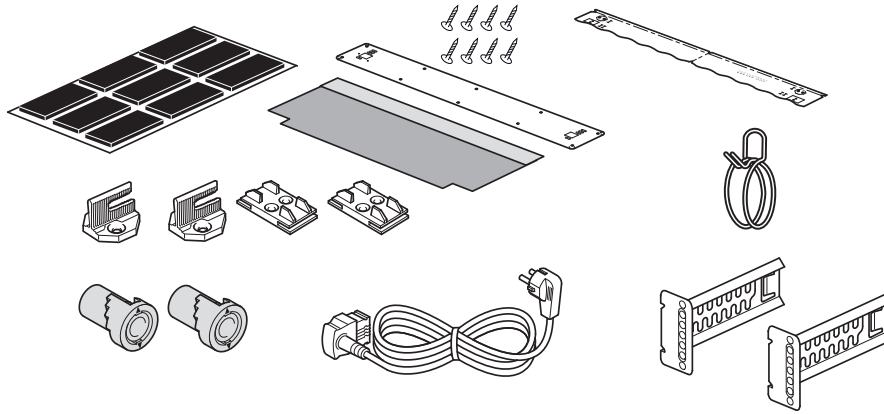
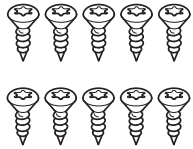

Torx
T 20 Torx
T 15

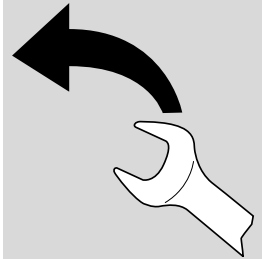
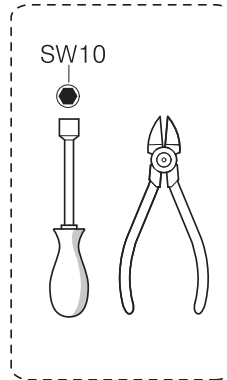
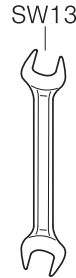
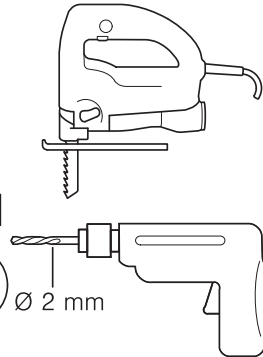
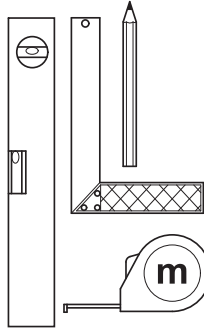
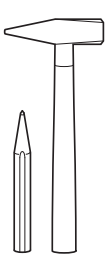
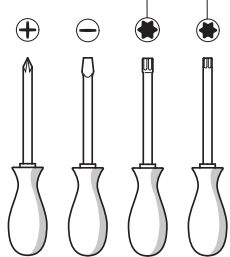

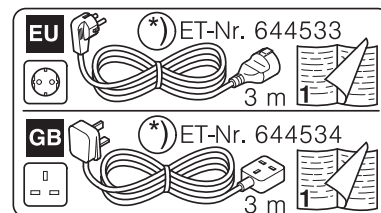
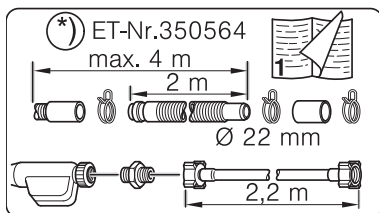
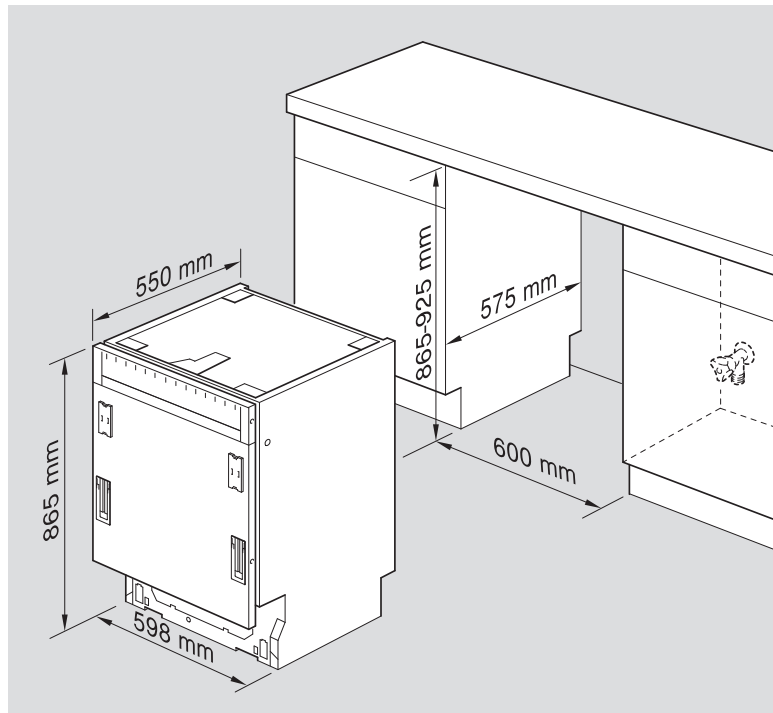
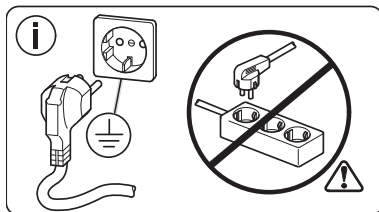
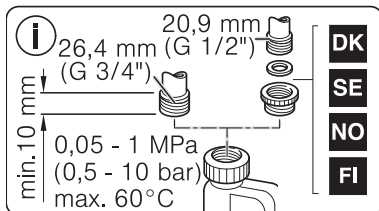
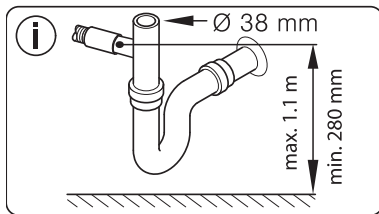

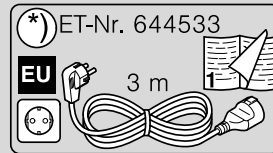
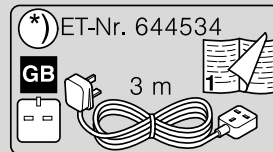
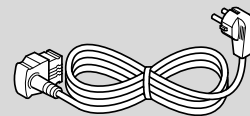
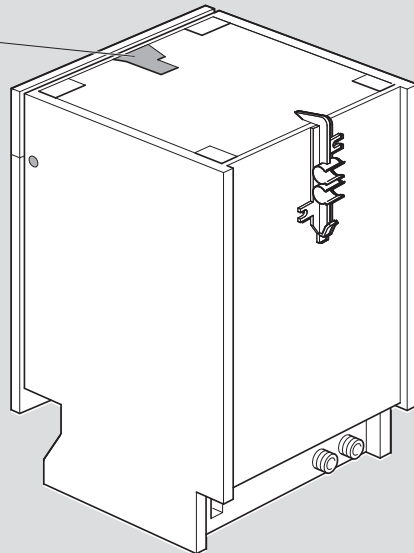
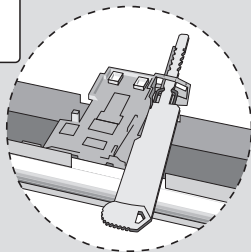
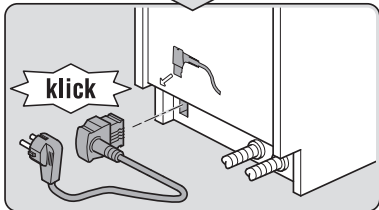
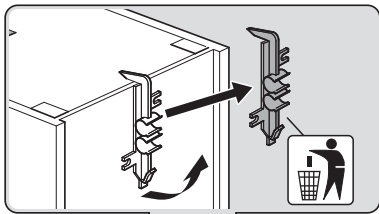

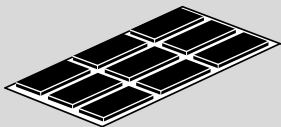
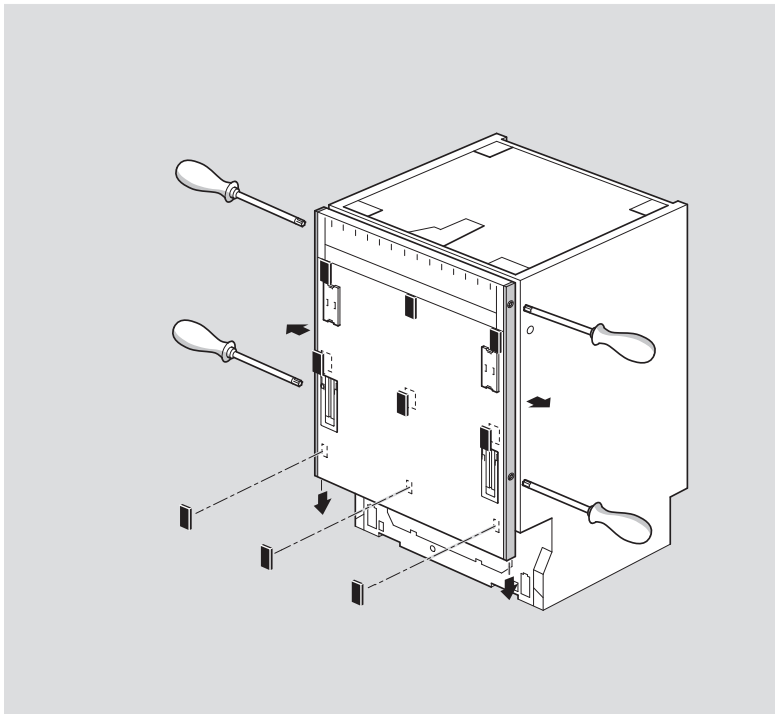
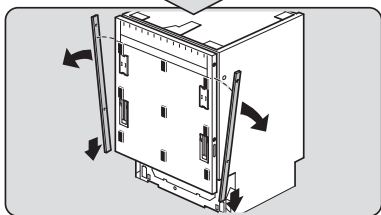
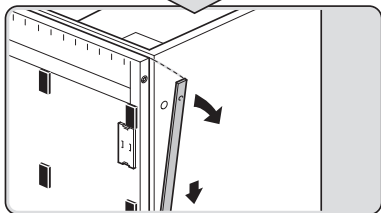
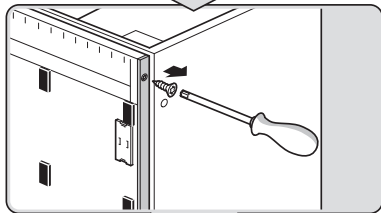
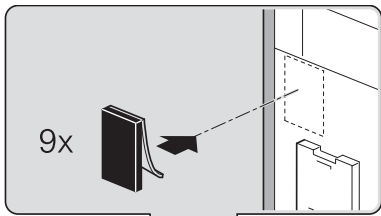

Torx
T 15



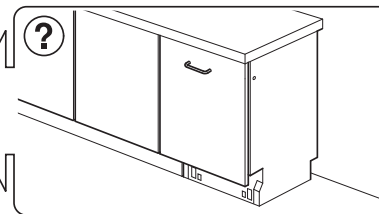
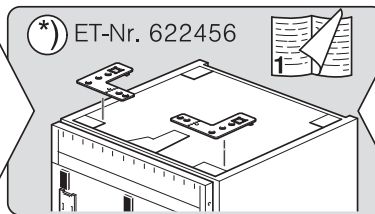
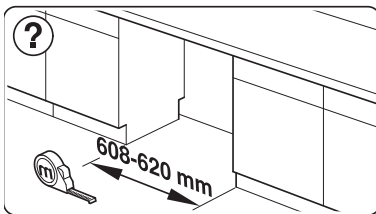
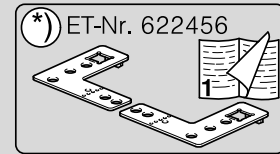
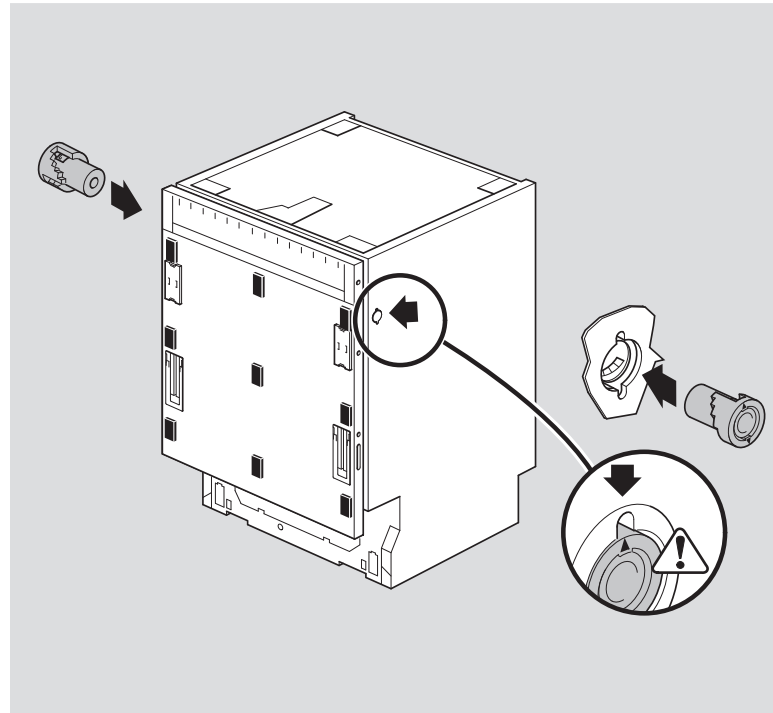
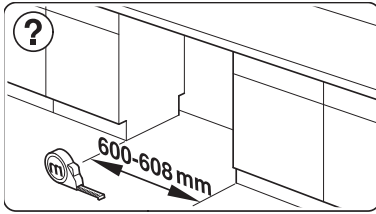

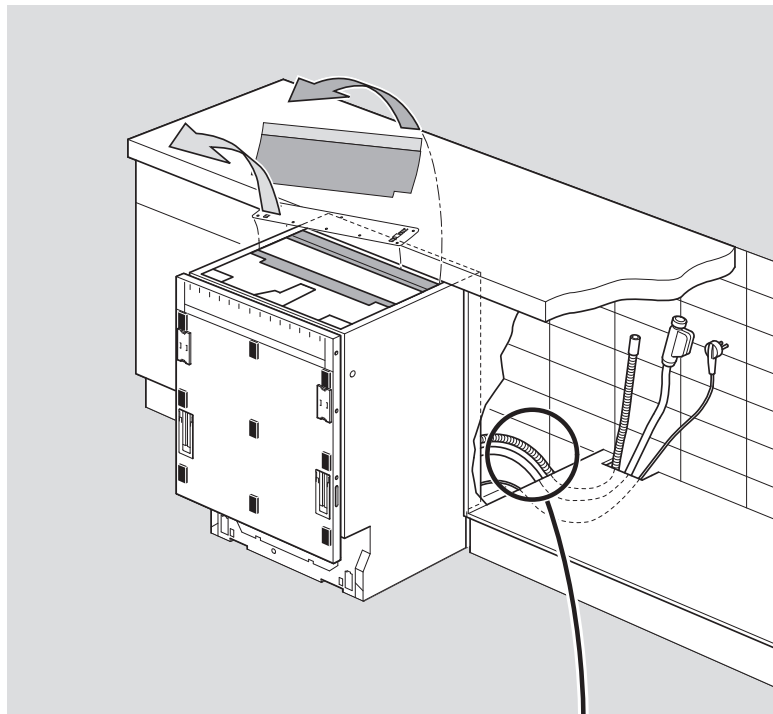
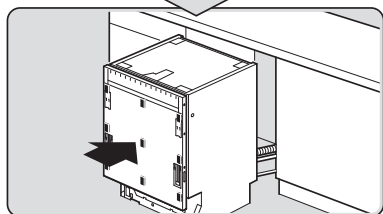
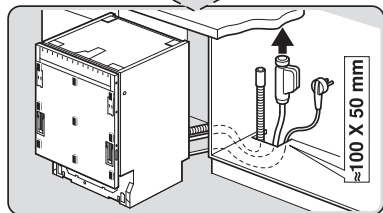
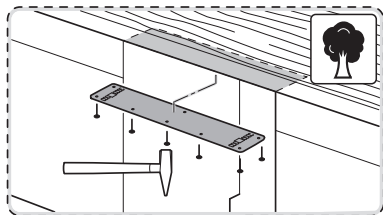
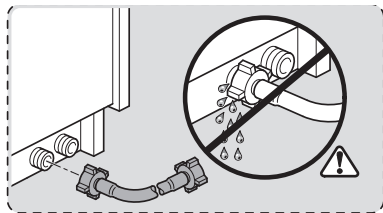

nicht einklemmen
do not pinch
ne pas coincer
No doblar

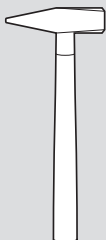
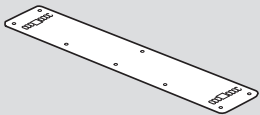
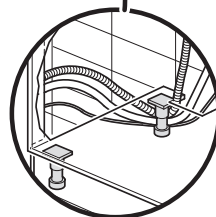

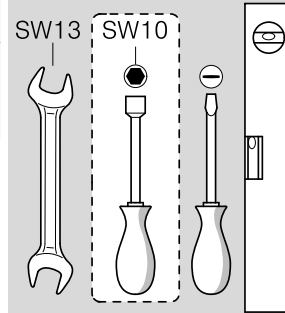
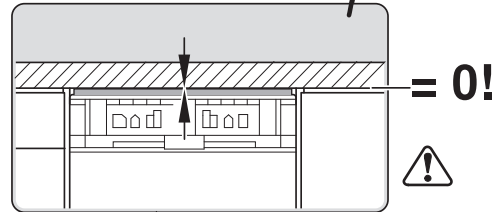
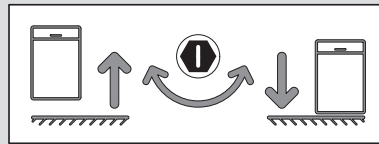
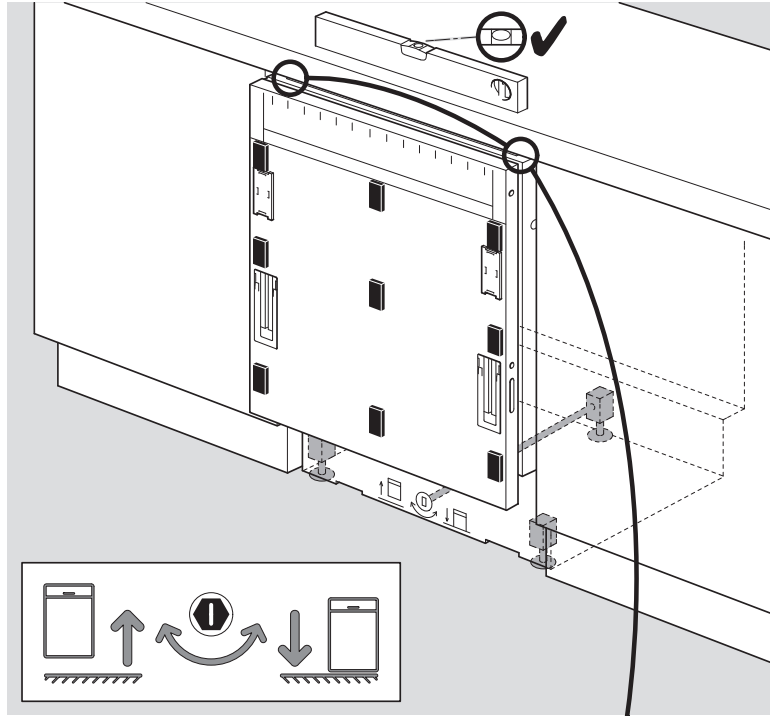
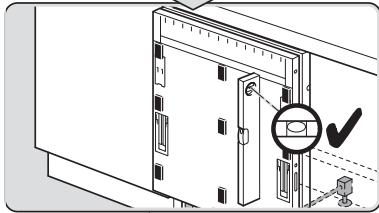
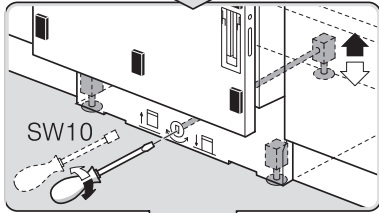
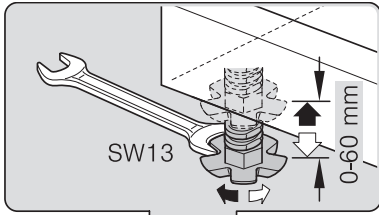

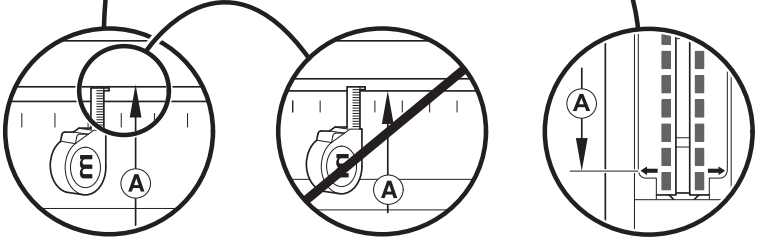
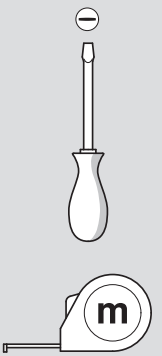
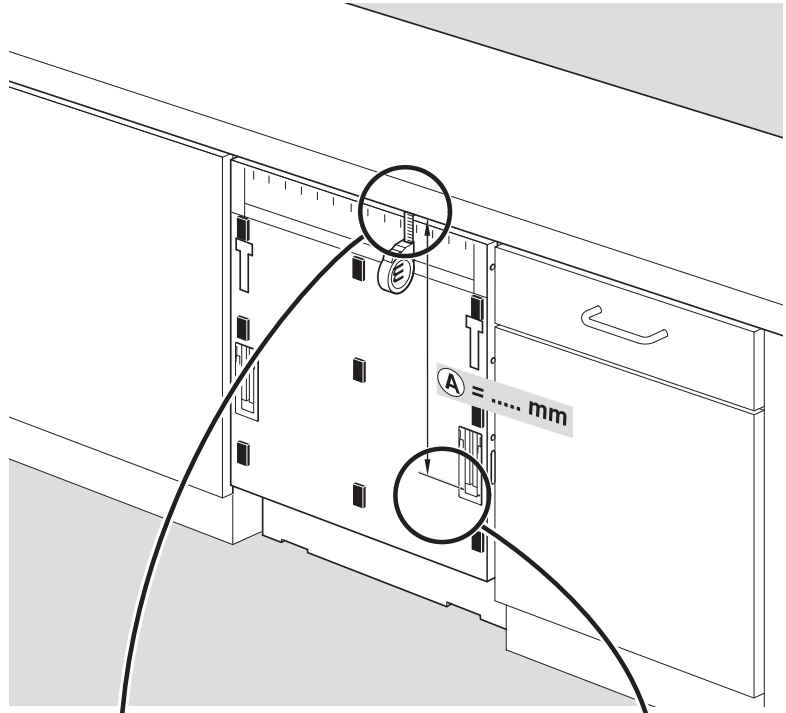
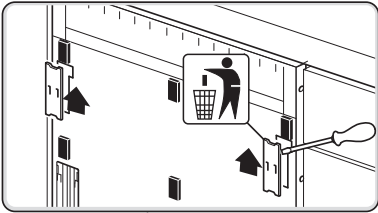

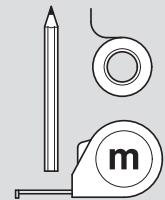
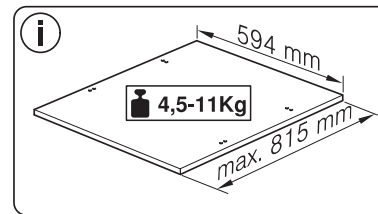
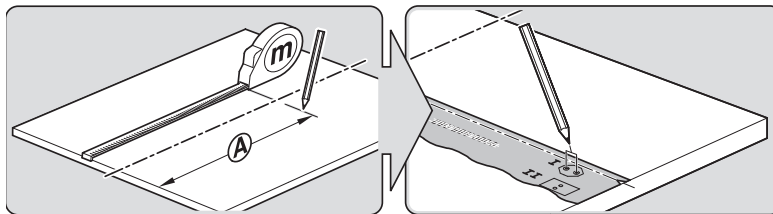
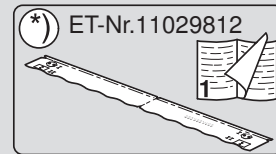
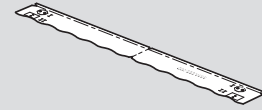
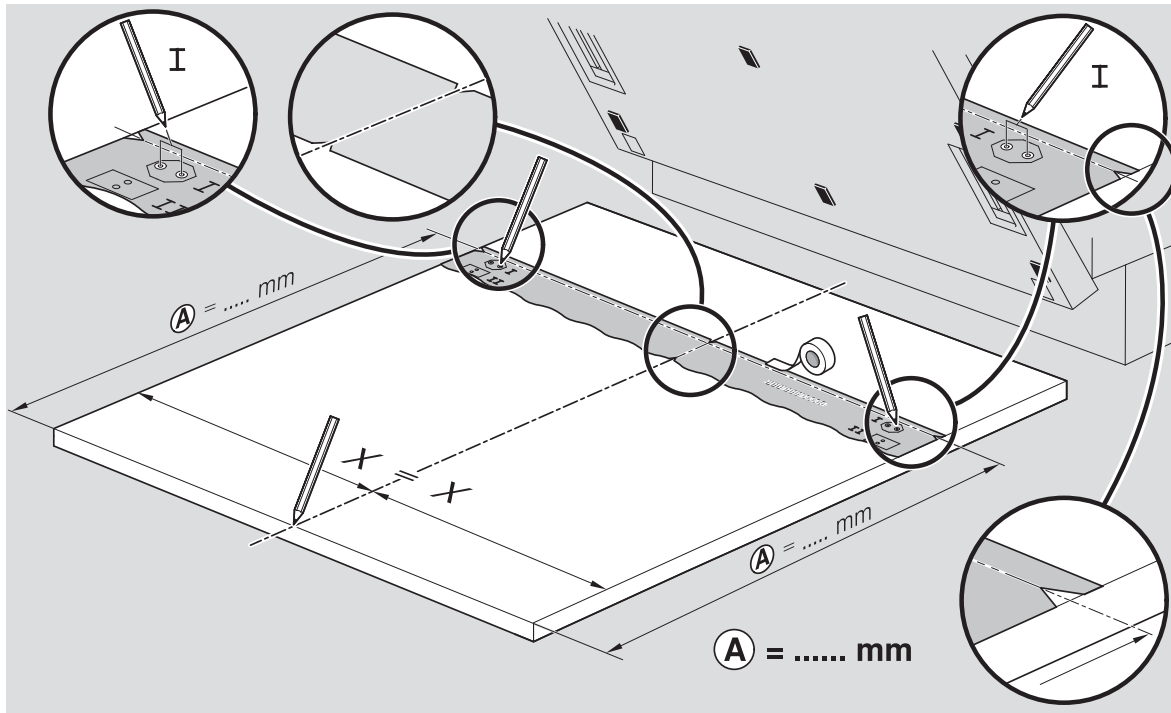

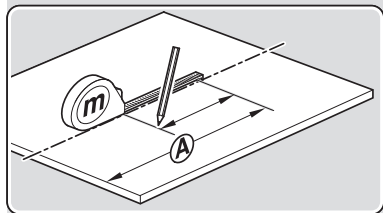
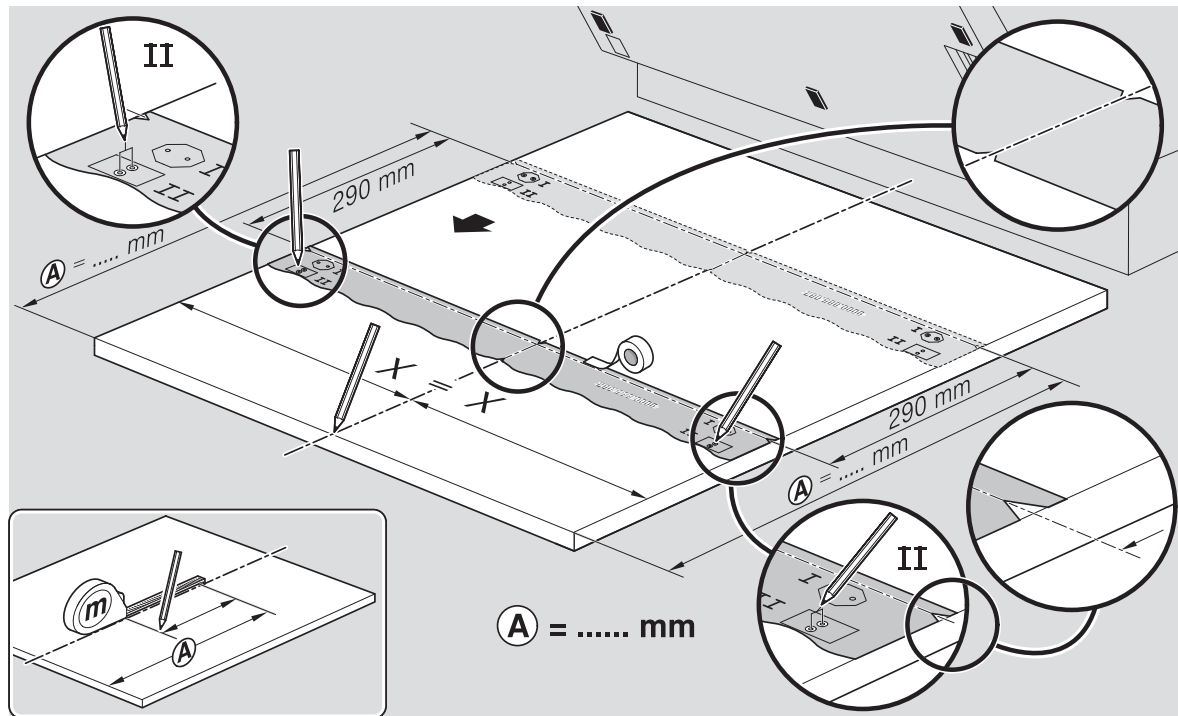

$A = \dots \text{ mm}$

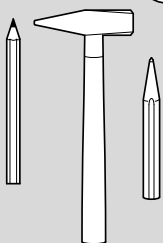
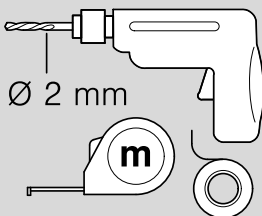
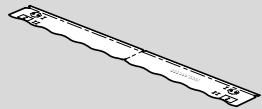
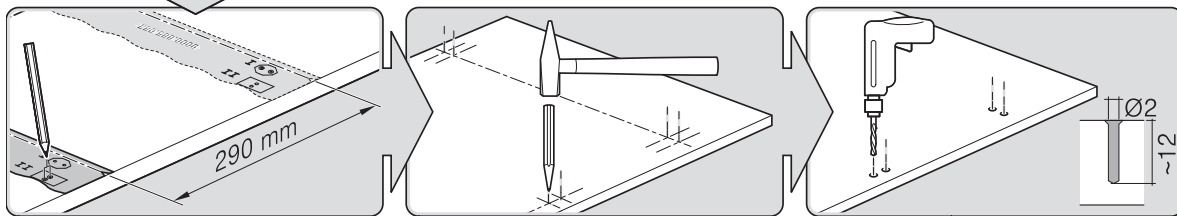

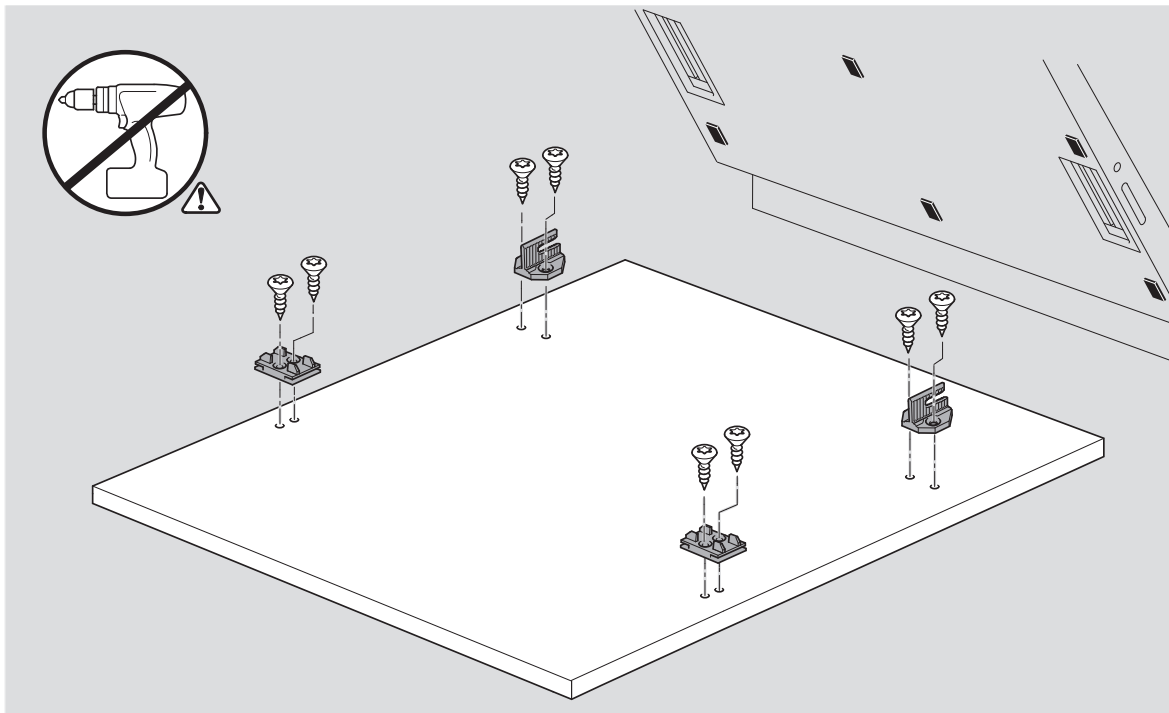

Ø4X15

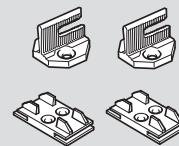
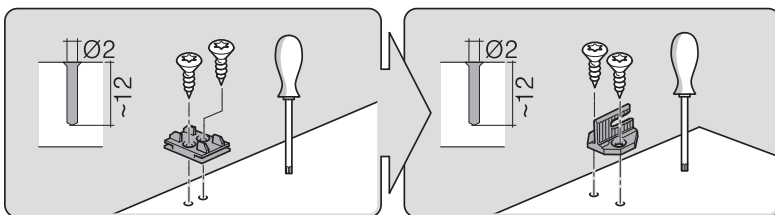
Torx
T 20

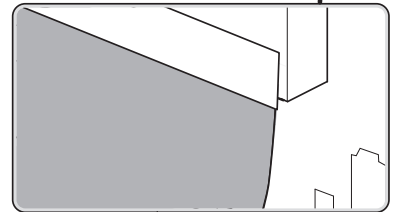
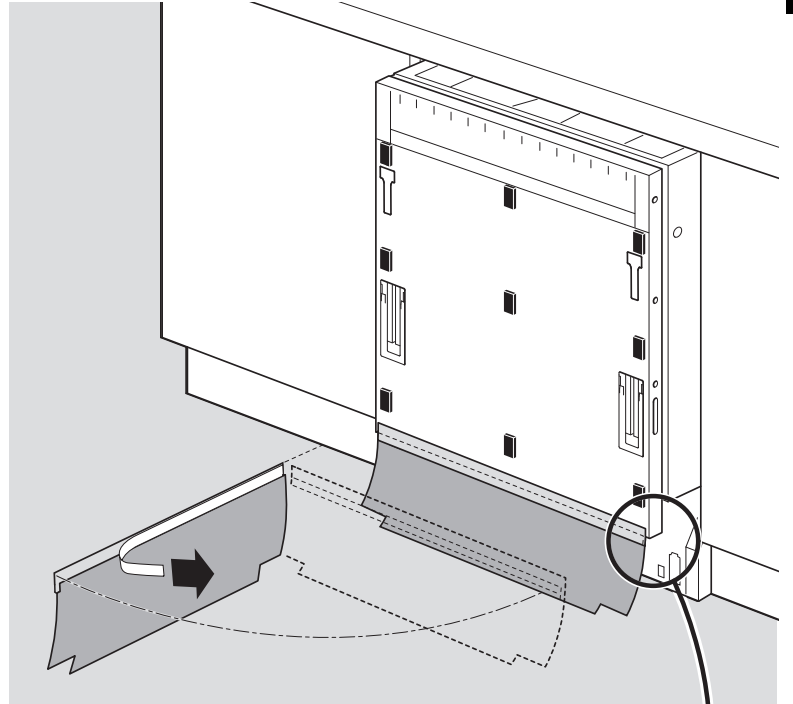
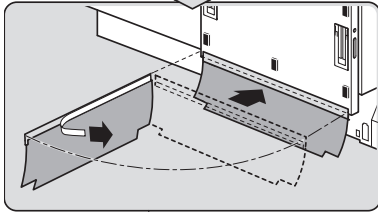
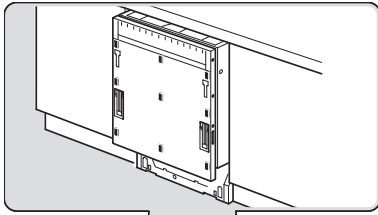
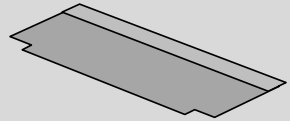

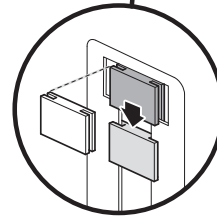
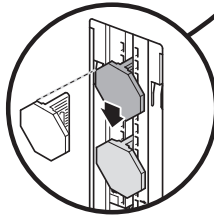
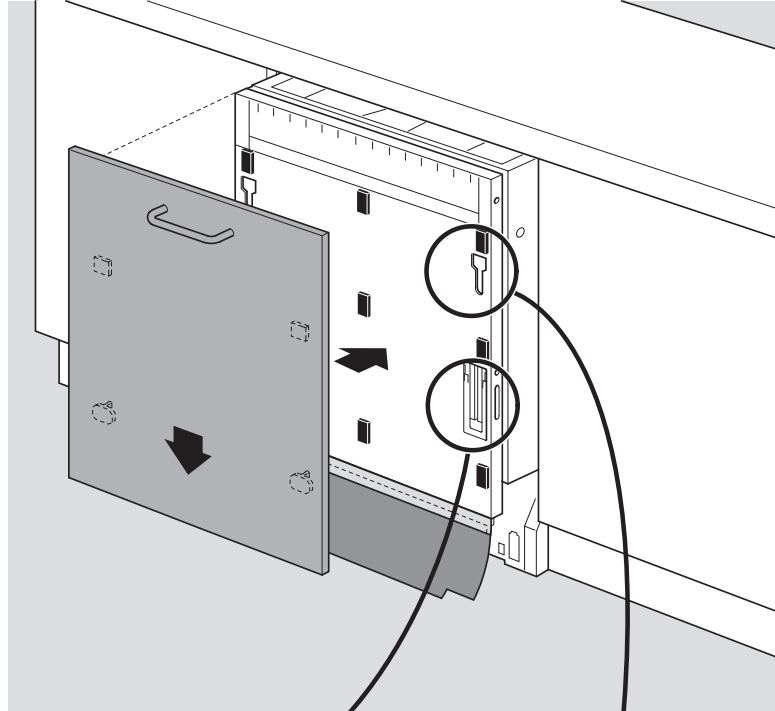
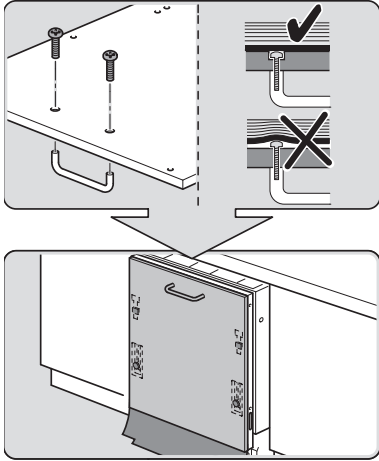

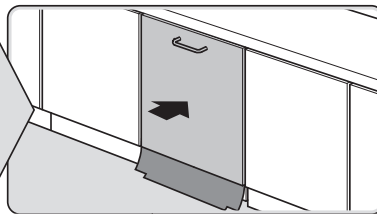
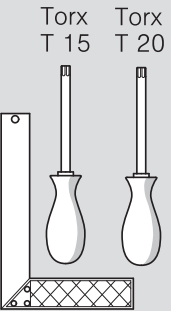
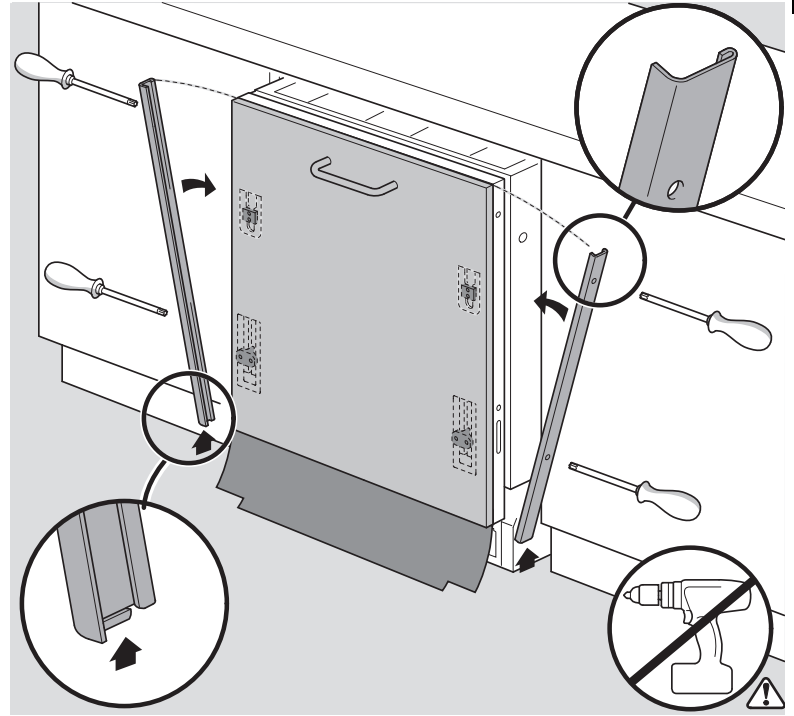
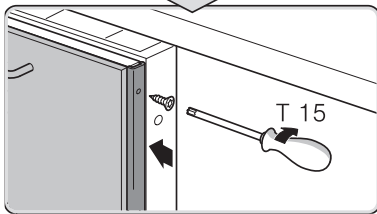
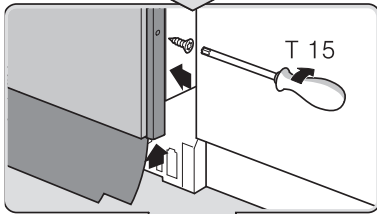
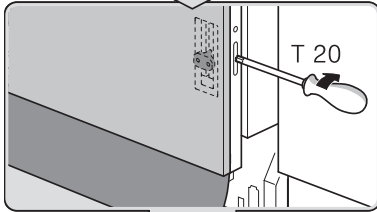
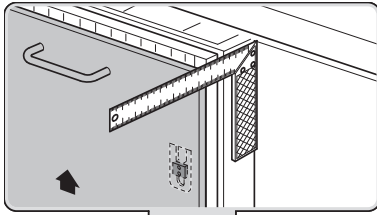

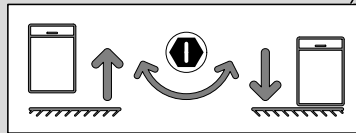
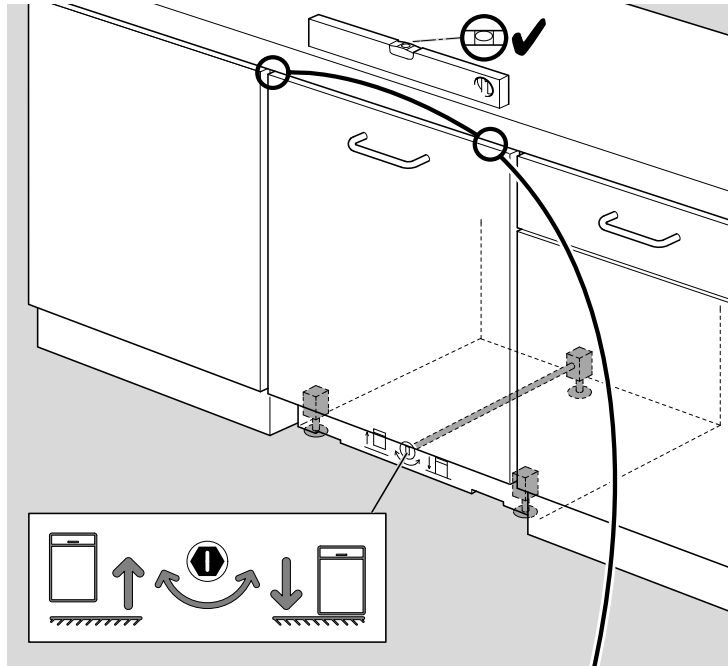
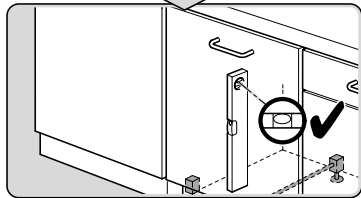
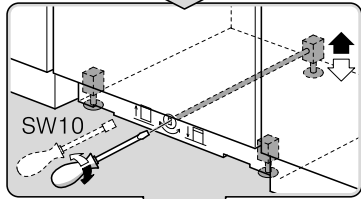
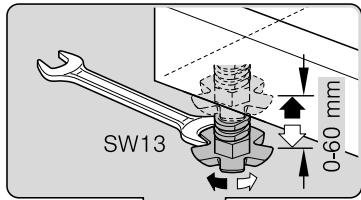

verspannen
brace
calar verticalment
Enrasar

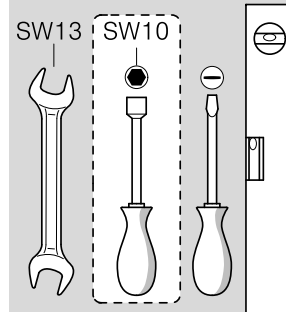
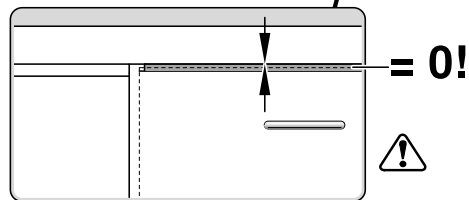



Ø4X36

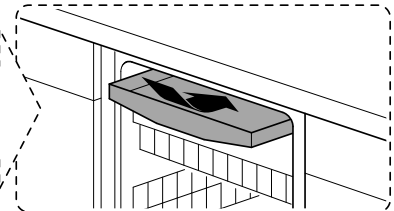
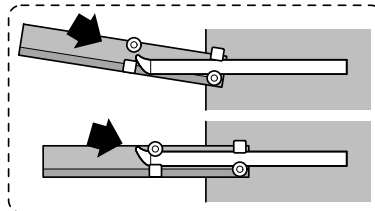
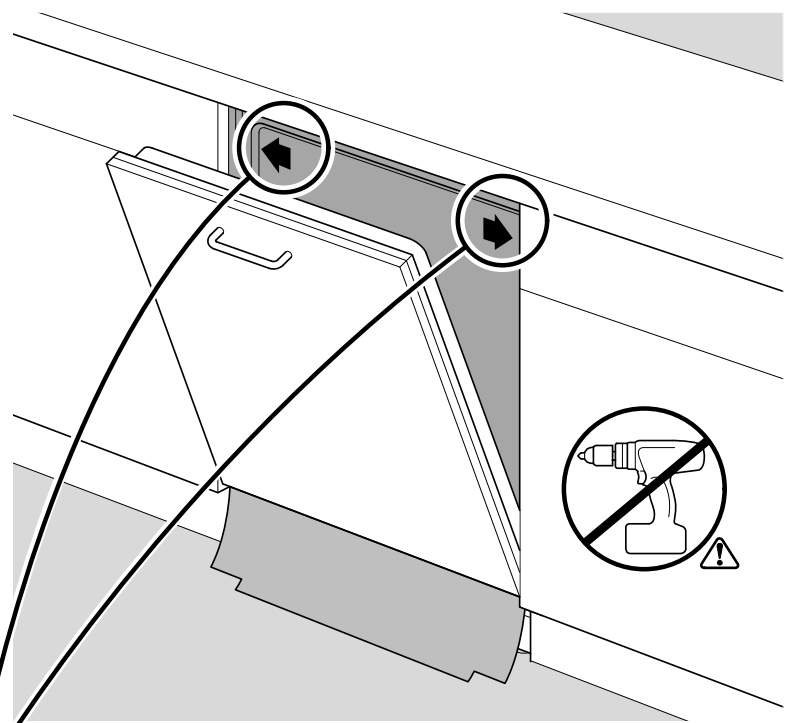
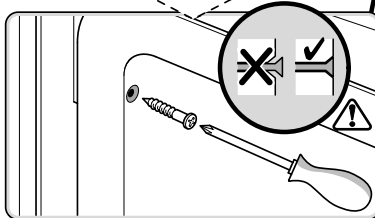
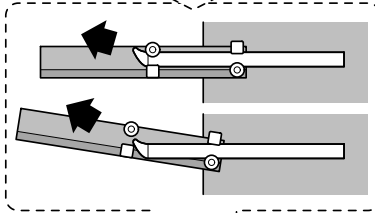
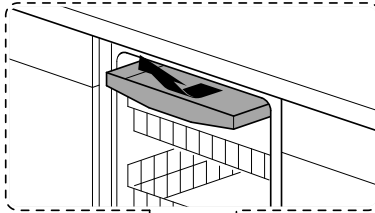
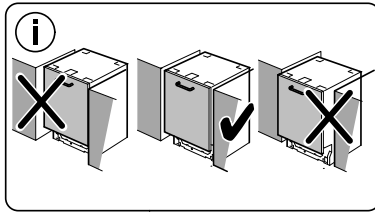

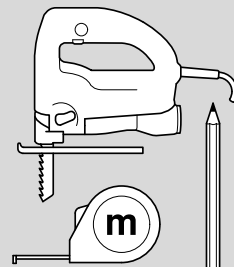
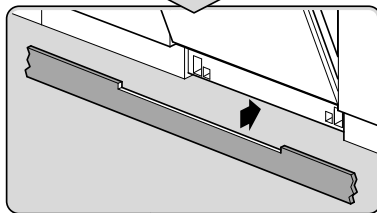
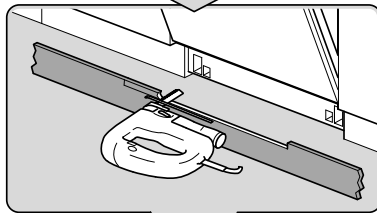
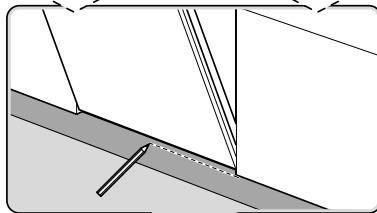
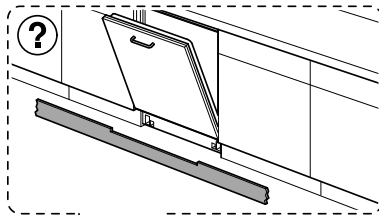
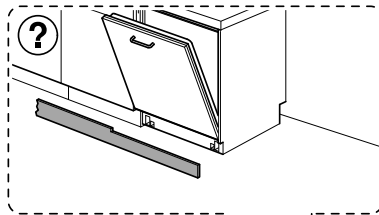
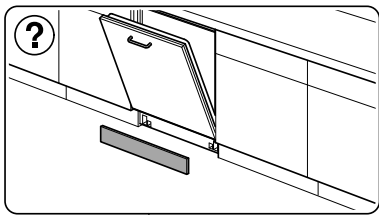

Ø4X15

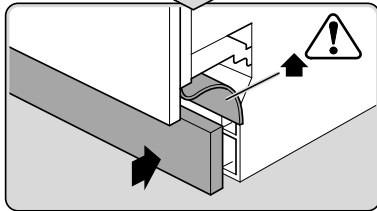
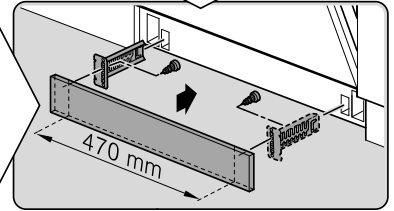
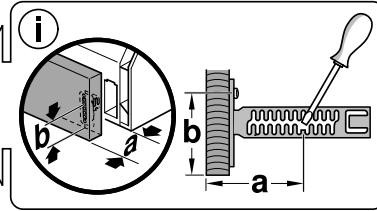
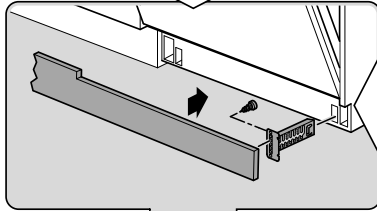
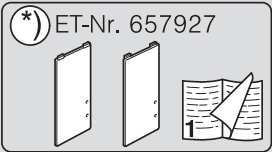
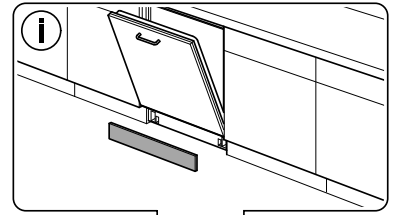
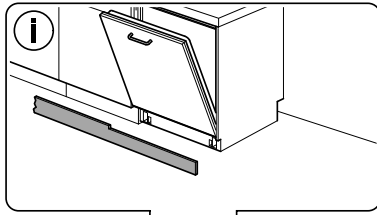
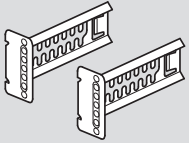

Torx
T 20

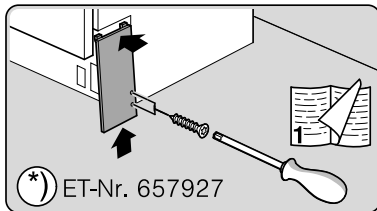

(*) ET-Nr. 657927

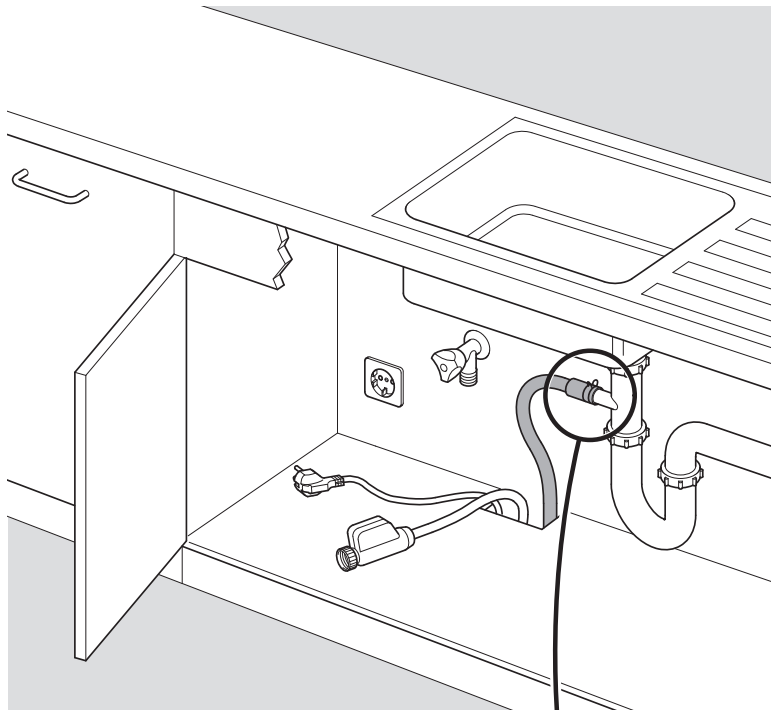
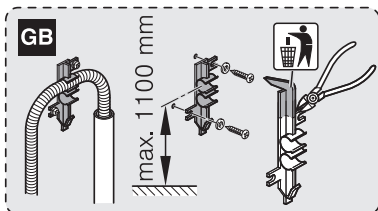
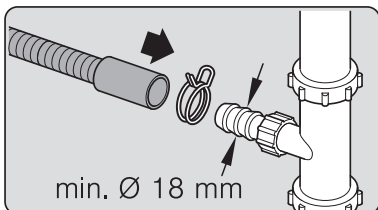
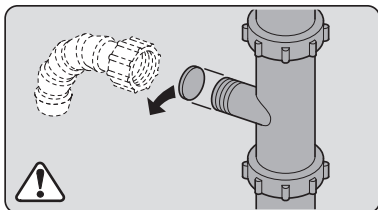
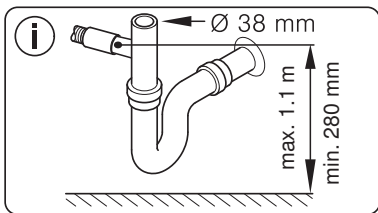

Dichtheit prüfen
Check for leaks
Verifiez l'étanchéité
Verificar la estanqueidad

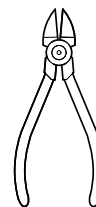
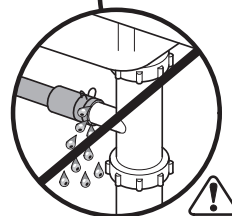

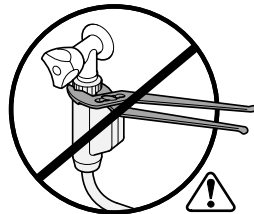
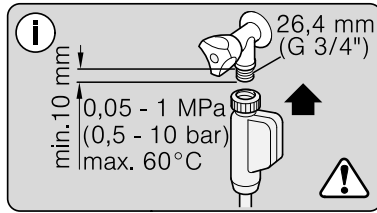

max. 10 Nm

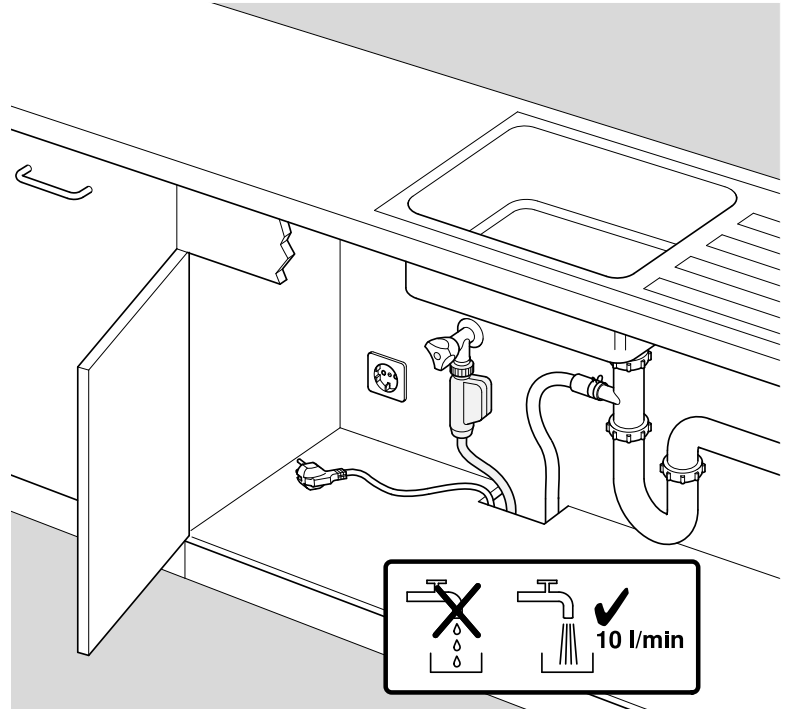

Dichtheit prüfen
Check for leaks
Verifiez l'étanchéité
Verificar la estanqueidad



