



Built-in oven



[en] INSTRUCTION MANUAL

C18FT48.1



Table of contents

 Intended use	4	 Time-setting options	21
 Important safety information	5	Showing and hiding the time-setting options	21
General information	5	Setting the timer	21
Steam	6	Setting the cooking time	22
Meat thermometer	6	Start delay – "Ready at"	22
 Causes of damage	6	Checking, changing or deleting settings	22
General information	6	 Childproof lock	22
Steam	7	Automatic childproof lock	22
 Environmental protection	7	One-time childproof lock	23
Saving energy	7	 Basic settings	23
Environmentally-friendly disposal	8	Changing MyProfile	23
 Getting to know your appliance	9	List of basic settings	23
Control panel	9	Setting favourites	24
Controls	9	 Baking and roasting assistant	24
Main menu	10	Information on the settings	24
Menu for the types of heating	10	Selecting a meal	24
Cooking compartment functions	11	Selecting and setting food	25
Water tank	11	 Programmes	25
 Accessories	12	Information on the settings	25
Accessories included	12	Selecting a dish	25
Inserting accessories	12	Setting a programme	26
Combining accessories	13	 Meat thermometer	27
Optional accessories	13	Suitable types of heating	27
 Before using for the first time	14	Inserting the meat probe into the food	27
Before using for the first time	14	Core temperatures of different foods	27
Initial use	14	Setting and starting the appliance operation	28
Calibrating the appliance and cleaning the cooking compartment	14	Changing or cancelling the appliance operation	28
Cleaning the accessories	15	 Sabbath mode	29
 Operating the appliance	15	Starting the Sabbath mode	29
Switching the appliance on and off	15	Cancelling Sabbath mode	29
Setting and starting the appliance operation	15	 Cleaning agent	29
Changing or cancelling the appliance operation	16	Suitable cleaning agents	29
Heating up the appliance quickly	16	Surfaces in the cooking compartment	30
 Steam	17	Keeping the appliance clean	31
Noise	17	 Cleaning function	31
FullSteam – Steam cooking	17	EasyClean	31
VarioSteam – Steam-assisted cooking	17	Descaling	32
Dough proving setting	18	 Rails	33
Sous-vide	18	Changing the shelf position for the telescopic rail	33
Defrost setting	19	Detaching and refitting the rails	33
Reheating	19	 Appliance door	34
Filling the water tank	19	Removing and installing the door panels	34
After every steam operation	20		

	Trouble shooting	36
	Fault table	36
	Maximum operating time exceeded	37
	Cooking compartment bulbs	37
	Customer service	38
	E number and FD number	38
	Tested for you in our cooking studio	38
	Silicone moulds	38
	Cakes and small baked items	38
	Bread and rolls	42
	Pizza, quiche and savoury cakes	44
	Bakes and soufflés	46
	Poultry	47
	Meat	49
	Fish	52
	Vegetables, side dishes and eggs	54
	Dessert	57
	Menu cooking	58
	Eco types of heating	58
	Acrylamide in foodstuffs	60
	Slow cook	60
	Drying	61
	Preserving and juicing	62
	Sterilising bottles and hygiene	63
	Allowing the dough to prove at dough proving setting	63
	Sous-vide	64
	Defrosting	67
	Reheating	68
	Keeping warm	69
	Test dishes	69

Additional information on products, accessories, replacement parts and services can be found at www.neff-international.com and in the online shop www.neff-eshop.com

Intended use

Read these instructions carefully. Only then will you be able to operate your appliance safely and correctly. Retain the instruction manual and installation instructions for future use or for subsequent owners.

This appliance is only intended to be fully fitted in a kitchen. Observe the special installation instructions.

Check the appliance for damage after unpacking it. Do not connect the appliance if it has been damaged in transport.

Only a licensed professional may connect appliances without plugs. Damage caused by incorrect connection is not covered under warranty.

This appliance is intended for domestic use only. The appliance must only be used for the preparation of food and drink. The appliance must be supervised during operation. Only use this appliance indoors.

This appliance is intended for use up to a maximum height of 2000 metres above sea level.

This appliance may be used by children over the age of 8 years old and by persons with reduced physical, sensory or mental capabilities or by persons with a lack of experience or knowledge if they are supervised or are instructed by a person responsible for their safety how to use the appliance safely and have understood the associated hazards.

Children must not play with, on, or around the appliance. Children must not clean the appliance or carry out general maintenance unless they are at least 15 years old and are being supervised.

Keep children below the age of 8 years old at a safe distance from the appliance and power cable.

Always slide accessories into the cooking compartment the right way round.

→ "Accessories" on page 12

Important safety information

General information

Warning – Risk of fire!

- Combustible items stored in the cooking compartment may catch fire. Never store combustible items in the cooking compartment. Never open the appliance door if there is smoke inside. Switch off the appliance and unplug it from the mains or switch off the circuit breaker in the fuse box.
- Loose food remnants, fat and meat juices may catch fire. Before using the appliance, remove the worst of the food remnants from the cooking compartment, heating elements and accessories.
- A draught is created when the appliance door is opened. Greaseproof paper may come into contact with the heating element and catch fire. Do not place greaseproof paper loosely over accessories during preheating. Always weight down the greaseproof paper with a dish or a baking tin. Only cover the surface required with greaseproof paper. Greaseproof paper must not protrude over the accessories.

Warning – Risk of burns!

- The appliance becomes very hot. Never touch the interior surfaces of the cooking compartment or the heating elements. Always allow the appliance to cool down. Keep children at a safe distance.
- Accessories and ovenware become very hot. Always use oven gloves to remove accessories or ovenware from the cooking compartment.
- Alcoholic vapours may catch fire in the hot cooking compartment. Never prepare food containing large quantities of drinks with a high alcohol content. Only use small quantities of drinks with a high alcohol content. Open the appliance door with care.

Warning – Risk of scalding!

- The accessible parts become hot during operation. Never touch the hot parts. Keep children at a safe distance.
- When you open the appliance door, hot steam can escape. Steam may not be visible, depending on its temperature. When opening, do not stand too close to the appliance. Open the appliance door carefully. Keep children away.
- Water in a hot cooking compartment may create hot steam. Never pour water into the hot cooking compartment.

Warning – Risk of injury!

- Scratched glass in the appliance door may develop into a crack. Do not use a glass scraper, sharp or abrasive cleaning aids or detergents.
- The hinges on the appliance door move when opening and closing the door, and you may be trapped. Keep your hands away from the hinges.

Warning – Risk of electric shock!

- Incorrect repairs are dangerous. Repairs may only be carried out and damaged power cables replaced by one of our trained after-sales technicians. If the appliance is defective, unplug the appliance from the mains or switch off the circuit breaker in the fuse box. Contact the after-sales service.
- The cable insulation on electrical appliances may melt when touching hot parts of the appliance. Never bring electrical appliance cables into contact with hot parts of the appliance.
- Do not use any high-pressure cleaners or steam cleaners, which can result in an electric shock.
- A defective appliance may cause electric shock. Never switch on a defective appliance. Unplug the appliance from the mains or switch off the circuit breaker in the fuse box. Contact the after-sales service.

⚠ Warning – Hazard due to magnetism!

Permanent magnets are used in the control panel or in the control elements. They may affect electronic implants, e.g. heart pacemakers or insulin pumps. Wearers of electronic implants must stay at least 10 cm away from the control panel.

Steam**⚠ Warning – Risk of scalding!**

- The water in the water tank may become very hot if you continue to operate the appliance. Empty the water tank after every operation with steam.
- Hot steam is generated in the cooking compartment. Do not reach into the cooking compartment during any operation with steam.
- Hot liquid may spill over the sides of the accessory when it is removed from the cooking compartment. Remove hot accessories with care and always wear oven gloves.

⚠ Warning – Risk of injury and risk of fire!

Flammable liquids can catch fire in the cooking compartment when it is hot (explosion). Do not fill the water tank with any flammable fluids (e.g. alcoholic drinks). Only fill the water tank with water or with the descaling solution that is recommended by us.

Meat thermometer**⚠ Warning – Risk of electric shock!**

The insulation of an incompatible meat thermometer may be damaged. Only use the meat thermometer which is recommended for this appliance.

 Causes of damage**General information****Caution!**

- Accessories, foil, greaseproof paper or ovenware on the cooking compartment floor: do not place accessories on the cooking compartment floor. Do not cover the cooking compartment floor with any sort of foil or greaseproof paper. Do not place ovenware on the cooking compartment floor if a temperature of over 50 °C has been set. This will cause heat to accumulate. The baking and roasting times will no longer be correct and the enamel will be damaged.
- Aluminium foil: Aluminium foil in the cooking compartment must not come into contact with the door glass. This could cause permanent discolouration of the door glass.
- Water in a hot cooking compartment: do not pour water into the cooking compartment when it is hot. This will cause steam. The temperature change can cause damage to the enamel.
- Moisture in the cooking compartment: Over an extended period of time, moisture in the cooking compartment may lead to corrosion. Allow the cooking compartment to dry after use. Do not keep moist food in the closed cooking compartment for extended periods of time. Do not store food in the cooking compartment.
- Cooling with the appliance door open: Following operation at high temperatures, only allow the cooking compartment to cool down with the door closed. Do not trap anything in the appliance door. Even if the door is only left open a crack, the front of nearby furniture may become damaged over time. Only leave the cooking compartment to dry with the door open if a lot of moisture was produced whilst the oven was operating.
- Fruit juice: when baking particularly juicy fruit pies, do not pack the baking tray too generously. Fruit juice dripping from the baking tray leaves stains that cannot be removed. If possible, use the deeper universal pan.
- Extremely dirty seal: If the seal is very dirty, the appliance door will no longer close properly during operation. The fronts of adjacent units could be damaged. Always keep the seal clean.
- Appliance door as a seat, shelf or worktop: Do not sit on the appliance door, or place or hang anything on it. Do not place any cookware or accessories on the appliance door.
- Inserting accessories: depending on the appliance model, accessories can scratch the door panel when closing the appliance door. Always insert the accessories into the cooking compartment as far as they will go.
- Carrying the appliance: do not carry or hold the appliance by the door handle. The door handle cannot support the weight of the appliance and could break.

Steam

Caution!

- Baking tins: Ovenware must be heat and steam resistant. Silicone baking tins are not suitable for combined operation with steam.
- Ovenware with areas of rust: Do not use any ovenware which displays areas of rust. Even the smallest spots of rust can lead to corrosion in the cooking compartment.
- Dripping liquids: When steaming with a perforated cooking container, always insert the baking tray, the universal pan or the solid cooking container underneath. Dripping liquid is caught.
- Hot water in the water tank: Hot water can damage the pump. Only fill the water tank with cold water.
- Enamel damage: Do not start any operations when there is water on the cooking compartment floor. Before operation, wipe away the water from the cooking compartment floor.
- Descaling solution: Do not allow any descaling solution to come into contact with the control panel or other surfaces on the appliance. This damages the surfaces. If this does happen, remove the descaling solution immediately with water.
- Cleaning the water tank: Do not clean the water tank in the dishwasher. Otherwise, the water tank will be damaged. Clean the water tank with a soft cloth and standard washing-up liquid.

Environmental protection

Your new appliance is particularly energy-efficient. Here you can find tips on how to save even more energy when using the appliance, and how to dispose of your appliance properly.

Saving energy

- Only preheat the appliance if this is specified in the recipe or in the tables in the operating instructions.
- Leave frozen food to defrost before placing it in the cooking compartment.

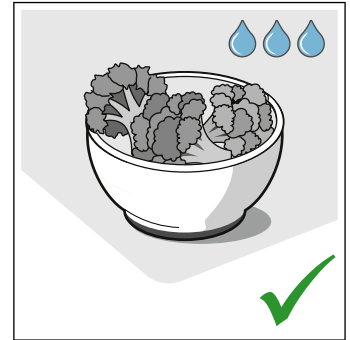
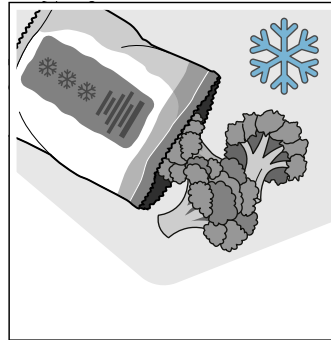

- Use baking tins that are dark-coloured, painted black or have an enamel coating. These absorb the heat particularly well.

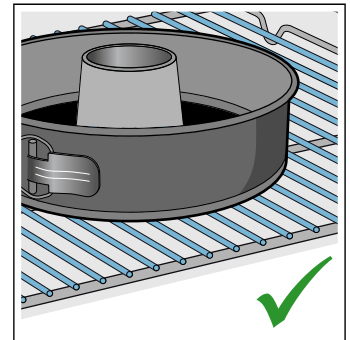
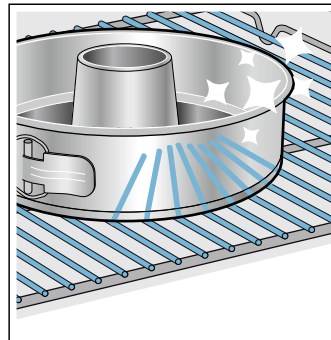

- Remove any unnecessary accessories from the cooking compartment.

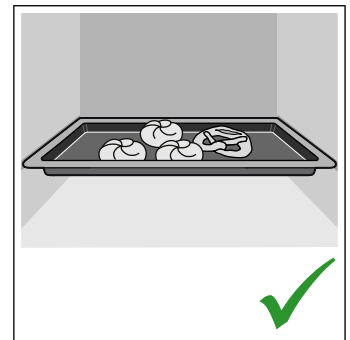
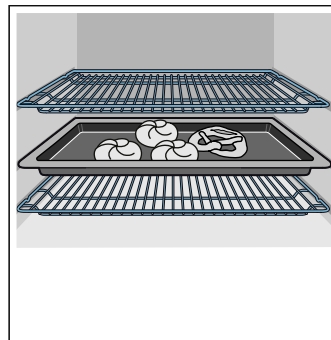

en Environmental protection

- Open the appliance door as infrequently as possible when the appliance is in use.

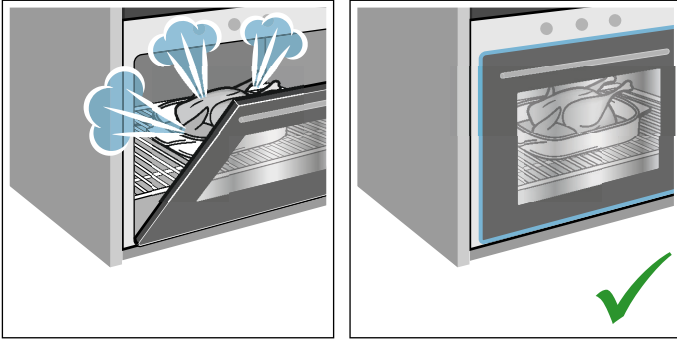

- It is best to bake several cakes one after the other. The cooking compartment stays warm. This reduces the baking time for the second cake. You can place two cake tins next to each other in the cooking compartment.

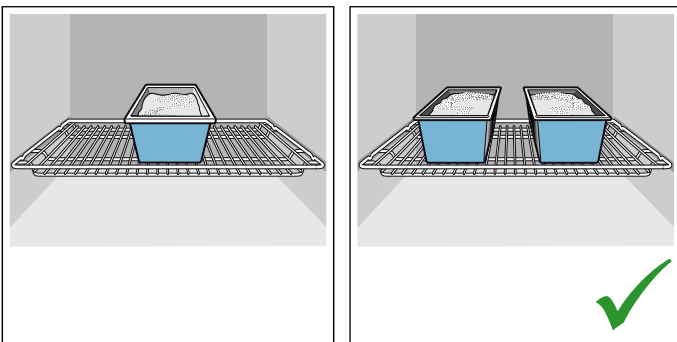

- For longer cooking times, you can switch the appliance off 10 minutes before the end of the cooking time and use the residual heat to finish cooking.

Environmentally-friendly disposal

Dispose of packaging in an environmentally-friendly manner.



This appliance is labelled in accordance with European Directive 2012/19/EU concerning used electrical and electronic appliances (waste electrical and electronic equipment - WEEE). The guideline determines the framework for the return and recycling of used appliances as applicable throughout the EU.

Getting to know your appliance

In this chapter, we will explain the indicators and controls. You will also find out about the various functions of your appliance.

Note: Depending on the appliance model, individual details and colours may differ.

Control panel

In the control panel, set your appliance's different functions using the FullTouch TFT display. The current settings are shown on the FullTouch TFT display.



1 FullTouch TFT display





2 Touch buttons





Controls

Use the controls to set your appliance simply and directly.

Touch buttons

There are sensors under the touch buttons. Touch on the corresponding touch button to select a function.

Touch button	Use
 on/off	Switching the appliance on or off → "Switching the appliance on and off" on page 15
 Steam-assisted cooking	Switching on steam-assisted cooking → "VarioSteam - Steam-assisted cooking" on page 17
 Time-setting options	Setting the timer, cooking time, or "Ready at" start delay → "Time-setting options" on page 21
Childproof lock	Activating or deactivating the childproof lock → "Childproof lock" on page 22
 Main menu	Selecting operating modes and settings → "Setting and starting the appliance operation" on page 15

 Rapid heating	Activating or deactivating rapid heating → "Heating up the appliance quickly" on page 16
	Activating or deactivating Power-Boost → "Heating up the appliance quickly" on page 16
 Information	Displaying further information Displaying the current temperature → "Setting and starting the appliance operation" on page 15
 Open cover	Filling or emptying the water tank → "Filling the water tank" on page 19
 Start/Stop	Starting or stopping the operation → "Setting and starting the appliance operation" on page 15

FullTouch TFT display



With the FullTouch TFT display, you can navigate through the lines and select settings.







To adjust a setting, touch the appropriate point on the display using your finger. The area is displayed more brightly. With your finger touching this area of the display, swipe to the left or right until the required setting is displayed larger.

Direction	Use
Navigate to the left	On the display, use your finger to swipe to the right
Navigate to the right	On the display, use your finger to swipe to the left
Navigate upwards	Touch the top line of the display
Navigate downwards	Touch the bottom line of the display

Main menu











Touch the  touch button to access the main menu.







Menu	Use
	Types of heating Selecting the required type of heating and temperature for your dish → "Switching the appliance on and off" on page 15
	Steam cooking Cooking with steam → "FullSteam – Steam cooking" on page 17

	Baking and roasting assistant Recommended settings for baking and roasting → "Baking and roasting assistant" on page 24
	Steam programmes Preparing dishes with steam → "Programmes" on page 25
	MyProfile Individually adjusting the appliance settings → "Basic settings" on page 23
	Descaling
	Drying Drying the cooking compartment after a steam operation → "After every steam operation" on page 20
	EasyClean Cleaning light soiling from the cooking compartment → "Cleaning function" on page 31

Menu for the types of heating

Your appliance has different types of heating. After switching on the appliance, you are taken directly to the menu for the types of heating.

Type of heating	Temperature	Use
 CircoTherm *	40 - 200 °C	For baking and cooking on one or more levels. The fan distributes the heat from the ring heating element in the back panel evenly around the cooking compartment.
 Top/bottom heating *	50 - 250 °C	For traditional baking and roasting on one level. Especially suitable for cakes with moist toppings. Heat is emitted evenly from the top and bottom.
 Circo-roasting *	50 - 250 °C	For roasting poultry, whole fish and larger pieces of meat. The grill element and the fan switch on and off alternately. The fan circulates the hot air around the food.
 Circotherm intensive	50 - 250 °C	For preparing pizza and dishes which require a lot of heat from underneath. The bottom heating element and the ring heating element in the back panel heat up.
 Bread-baking *	180 - 240 °C	For baking bread, bread rolls and baked items that require high temperatures.
 Full-surface grill	50 - 275 °C	For grilling flat items, such as steaks or sausages, for making toast, and for au gratin dishes. The whole area below the grill element becomes hot.
 Centre-area grill	50 - 275 °C	For grilling small amounts of steaks or sausages, for making toast, and for au gratin dishes. The centre area under the grill heating element becomes hot.
 Bottom heat	30 - 250 °C	For cooking in a bain marie and for the final baking stage. The heat is emitted from below.
 Low temperature cooking	70 - 120 °C	For gentle and slow cooking of seared, tender pieces of meat in ovenware without a lid. The heat is emitted evenly from the top and bottom at low temperatures.
 Dough proving **	2 levels	For leaving yeast dough and sourdough to prove and for culturing yogurt. Dough will prove more quickly than at room temperature. The surface of the dough does not dry out.

	Sous-vide **	50-95 °C	Cooking "under a vacuum" at low temperatures between 50 and 95 °C and 100% steam: Suitable for meat, fish, vegetables and desserts. A chamber vacuum-packing machine is used to heat-seal the food in special airtight, heat-resistant cooking bags. The protective envelope retains the nutrients and flavours.
	Defrost setting **	30 - 60 °C	For gently defrosting frozen food.
	Plate warming	30-70 °C	For preheating ovenware.
	Keep warm *	60 - 100 °C	For keeping cooked food warm.
	Top/bottom heating eco	50 - 250 °C	For gentle cooking of selected dishes. The heat is emitted from above and below.
	CircoTherm eco	40 - 200 °C	For gentle cooking of selected dishes on one level without preheating. The fan distributes the heat from the ring heating element in the back panel around the cooking compartment.
	Reheat **	80 - 180 °C	For gently reheating food or for crisping up pastries.
* Possible to use steam for this type of heating (operation only possible when the water tank is full)			
** Type of steam heating (operation only possible when the water tank is full)			

Cooking compartment functions

The functions in the cooking compartment make your appliance easier to use. This, for example, enables the cooking compartment to be well lit and a cooling fan to prevent the appliance from overheating.

Opening the appliance door

If you open the appliance door during an operation, the operation is paused. The operation continues to run when you close the door.

Note: For some types of heating, the operation continues to run even when the appliance door is open.

Interior lighting

If you open the appliance door, the interior lighting switches on. If the door remains open for longer than around 15 minutes, the lighting switches off again.

For most operating modes, the interior lighting switches on as soon as the operation is started. When the operation has finished, the lighting switches off.

Note: You can set the interior lighting not to come on during the operation in the basic settings. → "Basic settings" on page 23

Cooling fan

The cooling fan switches on and off as required. The hot air escapes above the door.

Caution!

Do not cover the ventilation slots. Otherwise, the appliance may overheat.

So that the cooking compartment cools down more quickly after the operation, the cooling fan continues to run for a certain period afterwards.

Note: You can change how long the cooling fan continues to run for in the basic settings. → "Basic settings" on page 23

Water tank

The appliance is fitted with a water tank. The water tank is behind the panel. For operations with steam, fill the water tank with water. → "Steam" on page 17

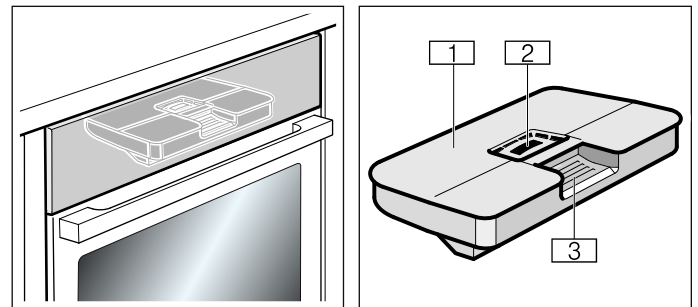

- 1 Tank cover
- 2 Filling opening
- 3 Handle for removing and inserting the water tank

Accessories

Your appliance is accompanied by a range of accessories. Here, you can find an overview of the accessories included and information on how to use them correctly.

Accessories included

Your appliance is equipped with the following accessories:

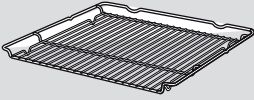
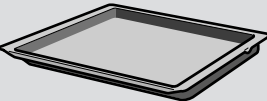
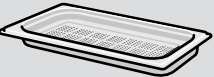
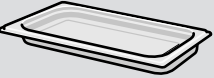
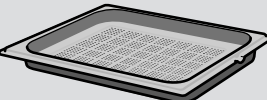
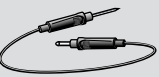
	<p>Wire rack For ovenware, cake tins and ovenproof dishes. For roasts, grilled items and frozen meals.</p>
	<p>Universal pan For moist cakes, other baked items, frozen meals and large roasts. It can be used to catch dripping fat when you are grilling directly on the wire rack. During operation with steam, it can also be used to catch drops of water.</p>
	<p>Steam container, perforated, size S For steaming vegetables, juicing berries and defrosting.</p>
	<p>Steam container, unperforated, size S For cooking rice, pulses and cereals.</p>
	<p>Steam container, perforated, size XL For steaming large quantities.</p>
	<p>Meat thermometer Enables precision roasting to your exact requirements. Its use is described in the relevant section. → "Meat thermometer" on page 27</p>

Only use genuine accessories. They are specially adapted for your appliance.

You can buy accessories from the after-sales service, from specialist retailers or online.

Note: The accessories may become deformed when they become hot. This does not affect their function. Once they cool down again, they regain their original shape.

Note: You can use the steam container with all heating modes involving steam without any restrictions. If you set other heating modes at high temperatures, take the steam container out of the cooking compartment. High temperatures can cause permanent deformations and discolouration of the steam container.

Inserting accessories

The cooking compartment has three shelf positions. The shelf positions are counted from the bottom up.

Warning – Risk of burns!

The telescopic shelves become hot when the appliance is in use. Take special care not to get burnt when they are pulled out.

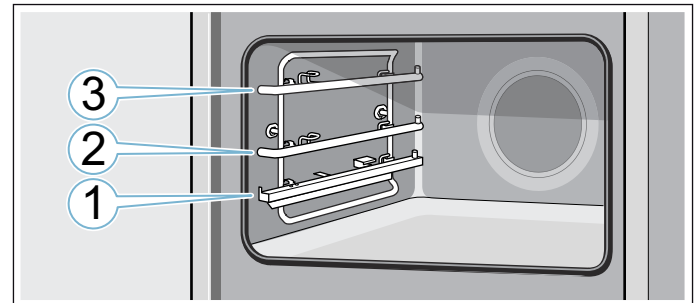

The accessories can be pulled out approximately halfway without tipping. You can use the pull-out rails to pull the accessories out further.

Ensure that the accessory is placed under the lug **a** on the pull-out rail.

Example in the picture: Universal pan

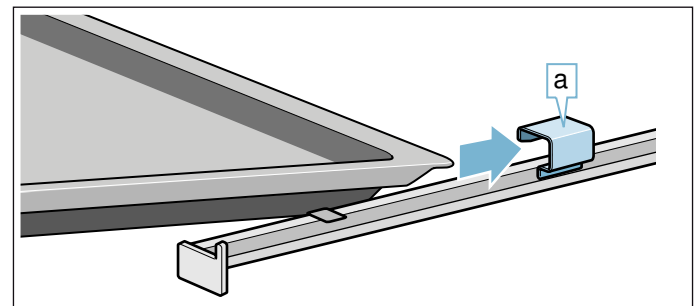

Accessories on the telescopic shelf can be pulled out as far as the notch **b** (fig. 1). Hold the accessory on both sides in the area marked **c** and remove it (fig. 2).

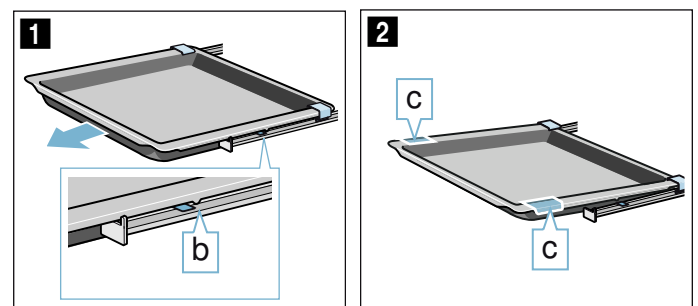

Notes

- Ensure that you always insert the accessories into the cooking compartment the right way round.
- Always insert the accessories fully into the cooking compartment so that they do not touch the appliance door.

Locking function

The accessories can be pulled out approximately halfway until they lock in place. The locking function prevents the accessories from tilting when they are pulled out. The accessories must be inserted into the cooking compartment correctly for the tilt protection to work properly.

When inserting the wire rack, ensure that the lug **a** is facing downwards.

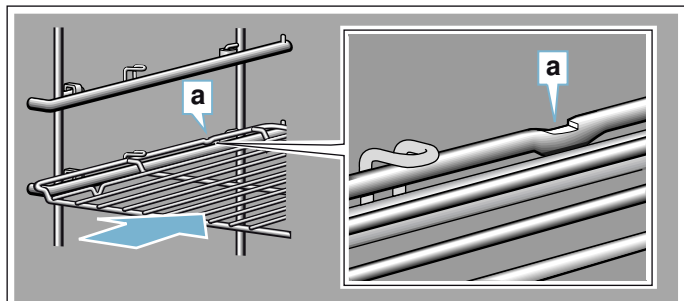

When inserting baking trays, ensure that the lug **b** is at the rear and is facing downwards. The sloping edge of the accessory **c** must be facing towards the appliance door.

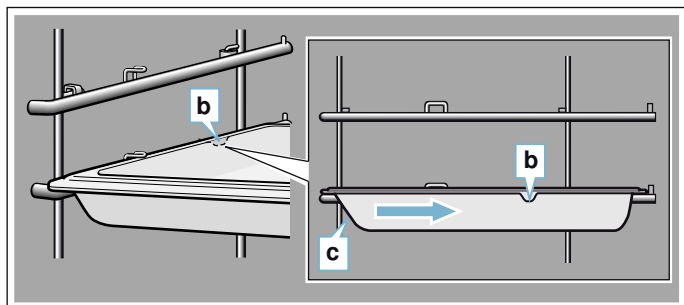

Combining accessories

You can insert the wire rack and the universal pan at the same time to catch drops of liquid.

When inserting the wire rack, ensure that both spacers **a** are at the rear edge. When the universal pan is inserted, the wire rack is on top of the upper guide rod of the shelf position.

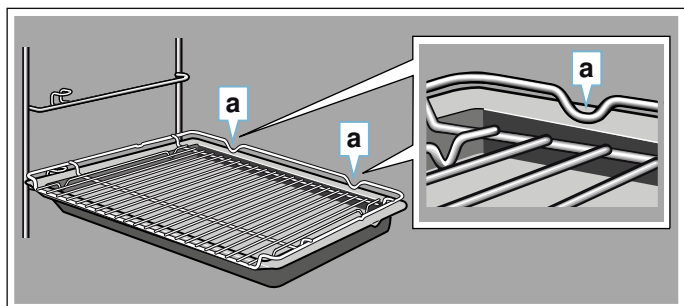

Small steam containers may only be placed in the cooking compartment with the wire rack.

Optional accessories

You can purchase optional accessories from the after-sales service and specialist retailers, or on the Internet. You will find a comprehensive range of products for your appliance in our brochures and on the Internet.

Both availability and whether it is possible to order online differ between countries. Please see your sales documents for more details.

Note: Not all optional accessories are suitable for every appliance. When purchasing, please always quote the exact designation (E no.) of your appliance.

→ "Customer service" on page 38

Optional accessories

Baking and roasting shelf, suitable for steaming

Baking tray

Universal pan

Baking tray, non-stick

Universal pan, non-stick

Extra-deep pan

Steam container, perforated, size XL

Steam container, perforated, size S

Steam container, unperforated, size S

Porcelain cooking container, unperforated, size S

Porcelain cooking container, unperforated, size L

Profi pan

Lid for the Profi pan

Pizza tray

Grill tray

Ceramic brick

Glass roasting dish, 5.1 litres

Glass pan

Decorative strip

ComfortFlex shelf (1 level) + frame*

ComfortFlex rail (1 level), suitable for steaming*

* Accessory does not fit in every appliance, quote the E no. when ordering



Before using for the first time

Before you can use your new appliance, you must make some settings. You must also clean the cooking compartment and accessories.

Before using for the first time

Before using the appliance for the first time, enquire about the water hardness of your tap water from your water supplier.

So that the appliance can reliably remind you to decalcify it when required, you must correctly set your water hardness range.

Caution!

The appliance may be damaged if unsuitable liquids are used.

Do not use distilled water, highly chlorinated tap water (>40 mg/l) or other liquids.

Only use cold, fresh tap water, softened water or uncarbonated mineral water.

Notes

- If your water is very hard, we recommend that you use softened water.
- If you only use softened water, you can set the water hardness range to "softened" in this case.
- If you use mineral water, set the water hardness range to "4 very hard".
- If you use mineral water, only use uncarbonated mineral water.

Water hardness range	Setting
0	0 softened
1 (up to 1.3 mmol/l)	1 soft
2 (1.3 - 2.5 mmol/l)	2 medium
3 (2.5 - 3.8 mmol/l)	3 hard
4 (above 3.8 mmol/l)	4 very hard

Initial use

As soon as the appliance is connected to the power supply, the first setting "Language" appears on the display.

Setting the language

1. Touch the bottom line.
2. Swipe to the left or right to select the required language.
3. Touch the top line.

Setting the time

1. Touch "Clock".
2. Touch the bottom line.
3. Swipe to the left or right to select the current hour.
4. Touch "Minutes".
5. Swipe to the left or right to select the current minute.
6. Touch the symbol to apply the setting.

Setting the date

1. Touch "Date".
2. Touch the bottom line.
3. Swipe to the left or right to select the current day.
4. Touch "Month".
5. Swipe to the left or right to select the current month.
6. Touch "Year".
7. Swipe to the left or right to select the current year.
8. Touch the symbol to apply the setting.

Setting the water hardness

1. Touch "Water hardness".
2. Touch the bottom line.
3. Swipe to the left or right to select the appropriate water hardness.
4. Touch the symbol to complete the initial use. The initial use is complete.

Notes

- You can change these settings at any time in the basic settings. → "Basic settings" on page 23
- After connecting the appliance to the power or following a power cut, the settings for initial use are shown in the display.

Calibrating the appliance and cleaning the cooking compartment

The boiling point of water depends on the air pressure. During calibration, the appliance sets itself to the pressure ratio at the installation location. This occurs automatically during the first steam operation. This results in a lot of steam.

Preparing the calibration

1. Remove the accessories from the cooking compartment.
2. Remove leftover packaging, such as polystyrene pellets, from the cooking compartment.
3. Before calibrating the appliance, wipe the smooth surfaces in the cooking compartment with a soft, wet cloth.

Calibrating the appliance and cleaning the cooking compartment

Notes

- The calibration can only be started once the cooking compartment is cold (room temperature).
 - Do not open the appliance door during calibration. Calibration will otherwise be interrupted.
1. Use the touch button to switch on the appliance.
 2. Fill the water tank. → "Filling the water tank" on page 19
 3. Set the heating type, temperature and duration for the calibration, then start the appliance operation. → "FullSteam – Steam cooking" on page 17

Calibration	
Heating type	Steam
Temperature	100 °C
Cooking time	30 minutes

4. After calibration, allow the appliance to heat up.

Caution!

Enamel damage

Do not start an operation if water is on the cooking compartment floor. Before the operation, wipe the water from the cooking compartment floor.

5. Dry the cooking compartment floor.
6. Set the heating type and temperature for heating up, then start the appliance operation. → "Setting and starting the appliance operation" on page 15

Heating up	
Heating type	Top/bottom heating 
Temperature	240 °C
Cooking time	30 minutes

7. Keep the kitchen ventilated while the appliance is heating up.
8. Stop the appliance operation after the indicated duration. Use the  touch button to switch off the appliance.
9. Wait until the cooking compartment has cooled down.
10. Clean the smooth surfaces with soapy water and a dish cloth.
11. Empty the water tank and dry the cooking compartment. → "After every steam operation" on page 20

Notes

- So that the appliance adapts to a new installation location after moving house, reset the appliance to the factory settings. Repeat the initial use settings and the calibration.
- The appliance saves the calibration settings, even in the event of a power cut or disconnection from the mains. The calibration must not be repeated.

Cleaning the accessories

Clean the accessories thoroughly using soapy water and a dish cloth or soft brush.



Operating the appliance

You have already learnt about the controls and how they work. Now we will explain how to set your appliance. You will learn about what happens when you switch the appliance on and off, and how to select the operating mode.

Switching the appliance on and off

To switch the appliance on or off, touch the  touch button.

After the appliance has switched off, the display shows whether the residual heat in the cooking compartment is high or low.



Display	Temperature
Residual heat high	above 120 °C
Residual heat low	between 60 °C und 120 °C

Notes

- Certain indicators and instructions (e.g. about residual heat in the cooking compartment) remain visible on the display even when the appliance is switched off.
- After the appliance has completed an operation, you will hear the cooling fan continuing to run until the cooking compartment is cooled as much as possible.
- Switch off your appliance when you do not need to use it. If no settings are made for a long time, the appliance switches off automatically.

Setting and starting the appliance operation

Example:  CircoTherm hot air at 170 °C

1. Touch the  touch button to switch on the appliance.
You go directly to the  Types of heating menu.



2. Swipe to the left or right to select the type of heating.
3. Touch the bottom line.
4. Swipe to the left or right to select the temperature.

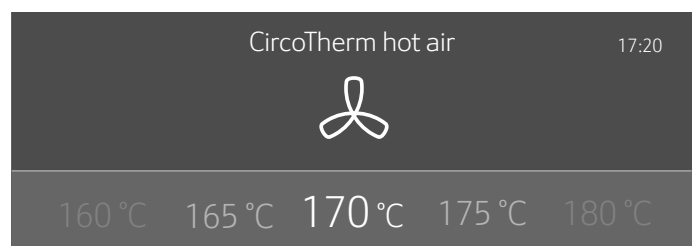

5. Touch the  touch button to start the appliance operation.
The heat-up indicator bar and the run time appear in the display.

Note: If you want to go directly to the  main menu when you switch on the appliance, you can find instructions on how to do this in the Basic settings chapter under "Operation after switching on".

Default values

The appliance suggests a temperature or setting for each type of heating. You can accept this value or change it in the appropriate area.

Heating bar

As soon as a type of heating has started, the heating bar appears on the display. The heating bar shows the temperature increase in the cooking compartment.

Run time



When a type of heating has been started, the run time is displayed. The run time counts upwards during the operation. You can therefore check how long the operation has already been running.

Displaying the current temperature

To show the current temperature on the display, press the  touch button.



The current temperature is shown briefly only when heating up.

Further information

If the  touch button lights up, information can be displayed. Touch the  touch button to do this. The information is displayed for a few seconds.

Changing or cancelling the appliance operation

Changing the appliance operation

1. Use the  button to stop the operation.
2. Tap the line for the setting that should be changed.
3. Swipe to the left or right to change the setting.
4. Use the  touch button to start the changed operation.

Notes

- The cooling fan may continue to run while an operation is interrupted.
- After a temperature change, the paused running time continues to count. After a change in the type of heating, the running time starts again from zero.



Cancelling the appliance operation

Press and hold the  touch button until the appliance operation is cancelled.

Note: Operating modes such as the cleaning function cannot be cancelled.



Heating up the appliance quickly

You can use the "Rapid heat-up" and "PowerBoost" functions to reduce the preheat time. Whether the appliance is preheated with the "Rapid heat-up" function or the "PowerBoost" function depends on the type of heating that has been set. With the "PowerBoost" function, unlike with the "Rapid heat-up" function, you can place your food into the cold cooking compartment even before preheating has begun. Only cook on one level when using the "PowerBoost" function.





Function	Type of heating	Place the food in the cooking compartment
Rapid heat-up	Top/bottom heating 	after preheating
PowerBoost*	CircoTherm hot air  Bread-baking setting 	before preheating

* Do not use more than one level for cooking







Notes

- If the  touch button is lit, the "Rapid heat-up" or "PowerBoost" function can be activated.
- To deactivate the "Rapid heat-up" or "PowerBoost" function before it has finished, touch the  touch button.

Activating the "Rapid heat-up" function

1. Set top/bottom heating  and the temperature.
Note: Set a temperature above 100 °C to allow the appliance to preheat quickly.
2. Touch the  touch button to start the appliance operation.
3. Touch the  touch button to activate the "Rapid heat-up" function.
The  symbol appears on the display.
4. Once the set temperature has been reached, the "Rapid heat-up" function switches itself off automatically. The  symbol disappears from the display. Place the food in the cooking compartment

Activating the "PowerBoost" function

1. Set CircoTherm hot air  or the bread baking setting  and the temperature.
Note: Set a temperature above 100 °C to allow the appliance to preheat quickly.
2. Place the food on a single level in the cooking compartment.
3. Touch the  touch button to start the appliance operation.
4. Touch the  touch button to activate the "PowerBoost" function.
The  symbol appears on the display. Once the set temperature has been reached, the "PowerBoost" function switches itself off automatically. The  symbol disappears from the display.

Steam

Food can be cooked particularly gently using steam. With some heating modes, you can prepare food with steam assistance. In addition, the Dough proving, Defrost and Reheat heating modes are available.

Warning – Risk of scalding!

When you open the appliance door, hot steam can escape. Steam may not be visible, depending on its temperature. When opening, do not stand too close to the appliance. Open the appliance door carefully. Keep children away.

Noise

Pump

You will hear a humming noise while the pump is in operation and after switching it off. This noise is caused by the pump function test. It is a normal operating noise.

Control panel





You will hear a humming or clicking noise when opening the control panel. These noises are caused by the control panel being pushed out. They are normal operating noises.

FullSteam – Steam cooking

During steaming, hot steam surrounds the food and therefore prevents loss of nutrients from the food. The shape, colour and typical aroma of the dishes are retained as a result of this preparation method.

Note: If the water tank runs dry during steaming, operation is interrupted. Fill the water tank.

Starting

1. Touch the  touch button.
2. Fill the water tank.
Note: Only switch on steaming once the cooking compartment has cooled down completely (to room temperature).
3. Touch the  touch button.
4. Swipe to the left or right to select "Steam .
5. Touch the bottom line.
6. Swipe to the left or the right to select the required temperature.
7. Touch the bottom line.
8. Swipe to the left or the right to select the required duration.
9. Touch the  touch button.
The appliance starts the operation.

As soon as the cooking time has elapsed, an audible signal sounds and the appliance ends the operation automatically. Touch the  touch button to end the audible signal.

Cancelling

Press and hold the  touch button until the appliance operation is cancelled.

Finishing

Touch the  touch button to switch the appliance off.

Menu cooking

With steam, you can cook a whole menu at once, without the different flavours mixing. → "Tested for you in our cooking studio" on page 38

VarioSteam – Steam-assisted cooking

When you cook with steam assistance, steam is introduced into the cooking compartment at various intervals and with varying degrees of intensity. This gives you a better cooking result.

Your food

- Becomes crispy on the outside
- Develops a shiny surface
- Is succulent and tender on the inside
- Only undergoes a minimum reduction in volume

You set the combination of heating mode and steam intensity that you want. Use the information in the tables to select a suitable heating mode and steam intensity. Alternatively, select a program from the steam programs. → "Tested for you in our cooking studio" on page 38 → "Programmes" on page 25





Steam intensity

Different intensity levels are available when adding steam:





- Low
- Medium
- High

Suitable heating modes

You can switch on steam assistance for these heating modes:

- CircoTherm hot air 
- Top/bottom heating 
- Circo-roasting 
- Bread-baking 
- Keeping warm 

Starting

1. Touch the  touch button.
2. Fill the water tank.
3. Set the type of heating and temperature.
4. Touch the  touch button to switch on steam assistance.
5. On the display, swipe to the left or right to select the steam intensity.
6. Touch the  symbol to apply the setting.
7. Touch the  touch button.
The appliance starts the operation.

Note: If the water tank runs dry during an operation with steam assistance, a message appears on the display prompting you to fill up the water tank.

Cancelling steam addition

1. Touch the ☹ touch button to cancel the addition of steam early.
2. Touch the set added steam in the bottom line.
3. On the display, swipe to the left or right to select "Off".
4. Touch the ☑ symbol to apply the setting.

Note: The operation continues without adding steam.

Cancelling appliance operation

Press and hold the ▷|| touch button until the appliance operation is cancelled.

Finishing

Touch the ⓪ touch button to switch the appliance off.

Dough proving setting

Dough will prove considerably more quickly using the "Dough proving ☹" heating mode than at room temperature and does not dry out.

There are two levels available for the Dough proving setting. Use the information in the tables to select the appropriate level. → *"Tested for you in our cooking studio" on page 38*

Note: If the water tank runs dry during operation with the Dough proving setting, operation is interrupted. Fill the water tank.

Starting

1. Touch the ⓪ touch button.
2. Fill the water tank.
Note: Only switch on the Dough proving setting once the cooking compartment has completely cooled down (to room temperature).
3. Swipe to the left or right to select "Dough proving".
4. Touch "1" in the bottom line.
5. Swipe to the left or right to select the required level.
6. Touch the ☑ symbol to apply the setting.
7. Touch "1→" in the bottom line.
8. Swipe to the left or right to select the required duration.
9. Touch the ☑ symbol to apply the setting.
10. Touch the ▷|| touch button.
The appliance starts the operation.

As soon as the cooking time has elapsed, an audible signal sounds and the appliance ends the operation automatically. Touch the ⓪ touch button to end the audible signal.

Cancelling

Press and hold the ▷|| touch button until the appliance operation is cancelled.

Finishing

Touch the ⓪ touch button to switch the appliance off.

Sous-vide

Sous-vide is a type of low-temperature cooking during which vacuum-sealed food is cooked at low temperatures between 50-95 °C and 100% steam. Sous-vide is suitable for meat, fish, vegetables and desserts.

A chamber vacuum-packing machine is used to heat-seal the food in special air-tight, heat-resistant cooking bags. The protective envelope retains the nutrients and flavours.

Notes

- If the water tank runs dry while sous-vide cooking, the operation is interrupted.
- During sous-vide cooking, more condensate forms on the cooking compartment floor than for other cooking methods.

Starting

Caution!

Risk of damage to kitchen units

Only fill the water tank once for sous-vide cooking. Do not fill the water tank a second time. Otherwise, large volumes of water will accumulate on the cooking compartment floor. The water may leak out of the cooking compartment.

1. Touch the ⓪ touch button.
2. Fill the water tank.
Note: Only activate the sous-vide function once the cooking compartment has cooled down completely (to room temperature).
3. Swipe to the left or right to select "Sous-vide ☹".
4. Touch the temperature in the bottom line.
5. Swipe to the left or the right to select the required temperature.
6. Touch "1→" in the bottom line.
7. Swipe to the left or the right to select the required duration.
8. Touch the ▷|| touch button.
The appliance will start running in this operating mode.

⚠ Warning – Risk of scalding!

Hot water collects on the vacuum-sealing bag during cooking. Use an oven cloth to carefully lift the vacuum-sealing bag, so that the hot water runs off into the universal pan or the cooking container. Then use the oven cloth to carefully remove the vacuum-sealing bag.

Once the cooking time has elapsed, an audible signal will sound and the appliance will bring the operating mode to an end automatically. Touch the ⓪ touch button to stop the signal tone.

Cancelling

Press and hold the ▷|| touch button until the appliance operation is cancelled.

Finishing

Touch the ⓪ touch button to switch the appliance off.

Defrost setting

Use the "Defrost ☼" heating mode to defrost frozen products.

Note: If the water tank runs dry during operation with the Defrost setting, operation is interrupted. Fill the water tank.

Starting

1. Touch the Ⓜ touch button.
2. Fill the water tank.
3. Swipe to the left or right to select "Defrost setting ☼".
4. Touch the temperature in the bottom line.
5. Swipe to the left or right to select the required temperature.
6. Touch the ☑ symbol to apply the setting.
7. Touch "▶" in the bottom line.
8. Swipe to the left or right to select the required duration.
9. Touch the ☑ symbol to apply the setting.
10. Touch the ⏸ touch button.
The appliance starts the operation.

As soon as the cooking time has elapsed, an audible signal sounds and the appliance ends the operation automatically. Touch the ⏹ touch button to end the audible signal.

Cancelling

Press and hold the ⏸ touch button until the appliance operation is cancelled.

Finishing

Touch the Ⓜ touch button to switch the appliance off.

Reheating

With the "Reheat ☼" heating mode, you can gently reheat food that has already been cooked or crisp up day-old baked goods. Steam is switched on automatically.

Note: If the water tank runs dry during operation with the Reheat setting, operation is interrupted. Fill the water tank.

Starting

1. Touch the Ⓜ touch button.
2. Fill the water tank.
3. Swipe to the left or right to select "Reheat ☼".
4. Touch the temperature in the bottom line.
5. Swipe to the left or right to select the required temperature.
6. Touch the ☑ symbol to apply the setting.
7. Touch "▶" in the bottom line.
8. Swipe to the left or right to select the required duration.
9. Touch the ☑ symbol to apply the setting.
10. Touch the ⏸ touch button.
The appliance starts the operation.

As soon as the cooking time has elapsed, an audible signal sounds and the appliance ends the operation automatically. Touch the ⏹ touch button to end the audible signal.

Cancelling

Press and hold the ⏸ touch button until the appliance operation is cancelled.

Finishing

Touch the Ⓜ touch button to switch the appliance off.

Filling the water tank

The water tank is located behind the control panel. Before starting an operation with steam, open the control panel and fill the water tank with water.

Make sure that you have set the water hardness range correctly. → "Basic settings" on page 23

⚠ Warning – Risk of injury and risk of fire!

Only fill the water tank with water or with the descaling solution that is recommended by us. Do not pour any flammable liquids (e.g. alcoholic drinks) into the water tank. Due to hot surfaces, vapours from flammable liquids may catch fire in the cooking compartment (explosion). The appliance door may spring open. Hot steam and jets of flame may escape.

⚠ Warning – Risk of burns!

The water tank may heat up while the appliance is in operation. Wait until the water tank has cooled down after the previous appliance operation. Remove the water tank from the water tank recess.

Caution!

The appliance may become damaged due to the use of unsuitable liquids.

Do not use distilled water, highly chlorinated tap water (> 40 mg/l) or other liquids.

Only use cold, fresh tap water, softened water or uncarbonated mineral water.

Notes

- If your water is very hard, we recommend that you use softened water.
- If you use only softened water, you can set your appliance to the "softened" water hardness range.
- If you use mineral water, set the water hardness range to "4 very hard".
- If you use mineral water, you must only use non-carbonated mineral water.

1. Touch the ☑ touch button.
The control panel is automatically pushed forwards.
2. Pull the control panel forwards with both hands and then push it upwards until it locks into place (fig. 1).
3. Lift the water tank and remove it from the water tank recess (fig. 2).

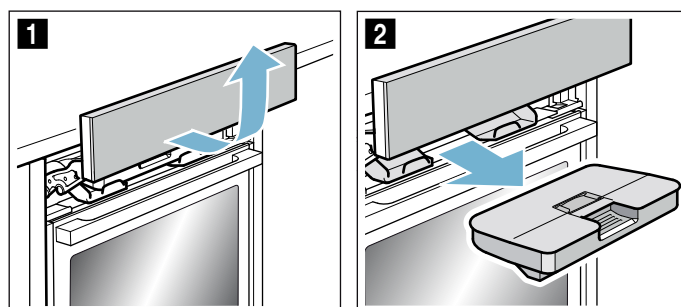

4. Press down on the lid along the seal to prevent water from leaking out of the water tank.
5. Remove the cover **a** (fig. 3).
6. Fill the water tank with cold water up to the "max." mark (fig. 4).

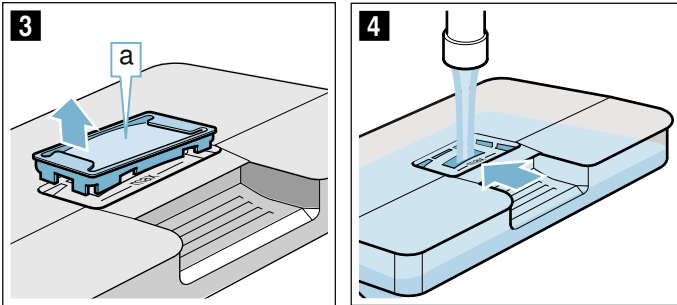

7. Reinsert the cover **a** into the opening in the water tank.
8. Insert the filled water tank (fig. 5). Ensure that the water tank locks into place behind both holders **b** (fig. 6).

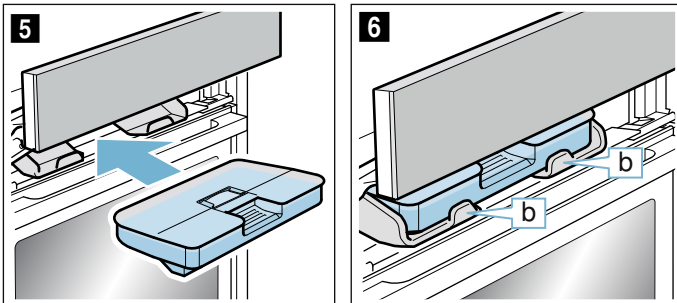

9. Slowly push the control panel downwards and then towards the rear until it is closed completely. The water tank has been filled. You can start operations with steam.

Refilling the water tank

Notes

- Steam-assisted operations continue without adding steam.
- If the water tank runs dry during operation with the Steaming, Dough proving, Defrost or Reheat settings, operation is interrupted. Fill the water tank.

1. Open the control panel.
2. Remove and refill the water tank.
3. Insert the filled water tank and close the control panel.

After every steam operation

⚠ Warning – Risk of scalding!

When you open the appliance door, hot steam can escape. Steam may not be visible, depending on its temperature. When opening, do not stand too close to the appliance. Open the appliance door carefully. Keep children away.

⚠ Warning – Risk of burns!

The appliance becomes hot during operation. Allow the appliance to cool down before cleaning.

Caution!

Enamel damage: Do not start any operations when there is water on the cooking compartment floor. Before operation, wipe away the water from the cooking compartment floor.

The remaining water is pumped back into the water tank after every operation with steam. Then empty and dry the water tank. Moisture remains in the cooking compartment. To dry the cooking compartment, you can either use the "Drying ☺☺☺" operating mode or dry the cooking compartment by hand.

Notes

- Once the appliance has been switched off, the ☺ touch button remains lit for a little longer to remind you to empty the water tank.
- Remove limescale marks with a cloth soaked in vinegar, then wipe with clean water and dry with a soft cloth.

Emptying the water tank

Caution!

- Do not dry the water tank in the hot cooking compartment. This will damage the water tank.
- Do not clean the water tank in the dishwasher. This will damage the water tank.

1. Open the control panel.
2. Remove water tank.
3. Carefully remove the lid of the water tank.
4. Empty the water tank, clean it with detergent and then rinse it thoroughly with clean water.
5. Dry all parts with a soft cloth.
6. Rub the seal on the lid until dry.
7. Leave to dry with the lid open.
8. Place the lid on the water tank and push it down.
9. Insert the water tank and close the control panel.

Cleaning the drip trough

1. Allow the appliance to cool down.
2. Open the appliance door.
3. Soak up the water in the drip trough **a** with a sponge cloth and wipe it carefully (figure 1). When you wipe it, be careful not to detach the seal **b** from the drip trough (figure 2).

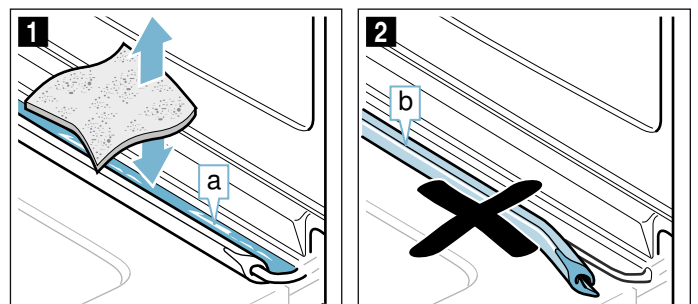

The drip trough **a** is located below the cooking compartment (figure **3**).

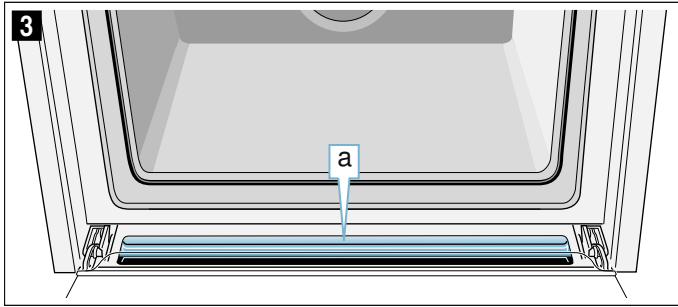





Note: If the seal has become detached, fit the seal back onto the drip trough. → "Appliance door" on page 34

Starting drying

To dry the cooking compartment, it is heated up so that the moisture in the cooking compartment evaporates. You will then need to open the appliance door to allow the steam to escape from the cooking compartment.

Caution!

Enamel damage: Do not start any operations when there is water on the cooking compartment floor. Before operation, wipe away the water from the cooking compartment floor.



1. Allow the appliance to cool down.
2. Remove the worst of the food remnants from the cooking compartment immediately and use a sponge to wipe away moisture from the cooking compartment floor.
3. If necessary, touch the  touch button to switch the appliance on.
4. Touch the  field to display the operating modes.
5. On the touch display, swipe to the left or right to select "Dry .
6. Touch the line at the bottom.
The duration will be displayed. It cannot be changed.
7. Touch the line at the bottom.
8. Touch the  field.
This starts the drying function; it will end automatically after 10 minutes.
9. Open the appliance door and leave it open for 1 to 2 minutes so that the moisture in the cooking compartment can escape.

Drying the cooking compartment by hand

1. Allow the appliance to cool down.
2. Remove any food remnants from the walls of the cooking compartment.
3. Dry the cooking compartment with a sponge.
4. Leave the appliance door open for 1 hour so that the cooking compartment dries completely.

Time-setting options

Your appliance has different time-setting options.

Time-setting option	Use
 Timer	The timer functions like an egg timer. The appliance does not switch on and off automatically.
 Cooking time	Once the set cooking time has elapsed, the appliance switches off automatically.
 Ready at	The appliance switches on automatically, and once the set cooking time has elapsed and the end time has passed, it switches off automatically.

Note: If you have set a time-setting option, the time interval increases if you set a higher value. Example: You can set a cooking time of up to one hour in one-minute increments; for cooking times over one hour, you can set a cooking time in five-minute increments.

Showing and hiding the time-setting options



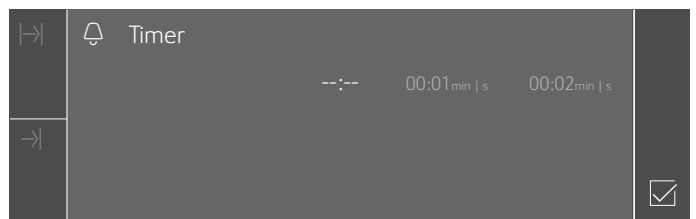

To show or hide the time-setting options, touch the  touch button.

Note: After a particular length of time, the time-setting options that are shown are automatically hidden. If you have already set a cooking time, it will be applied.



Setting the timer



The timer can be set when the appliance is switched on or off.

1. Touch the  touch button.
The time-setting options are shown on the display.
2. Swipe to the left or right to select the duration.
Note: With the appliance switched on, first touch " Timer" and then swipe to the left or right to select the duration.
3. Touch the  touch button.
The  symbol appears on the display.

Note: As soon as the set time has elapsed, a signal sounds. Touch the  touch button to end the audible signal.

Setting the cooking time

Once the set cooking time has elapsed, the appliance switches off automatically. The function can only be used in combination with a type of heating.

1. Touch the  touch button.
2. Set the type of heating and temperature.
3. Touch the  touch button.
The time-setting options are shown on the display.
4. Swipe to the left or right to select the cooking time.
5. Touch the  touch button to start the set cooking time.





As soon as the cooking time has elapsed, an audible signal sounds and the appliance ends the operation automatically. Touch the  touch button to end the audible signal.

Start delay – "Ready at"

The appliance switches on automatically and switches off at the preset end time. To do this, set the cooking time and determine the end time for the operation.

The start delay can only be used in combination with a type of heating.

Notes

- Ensure that food is not left in the cooking compartment for too long as it may spoil.
 - The option to delay the start of operation is not available for every type of heating.
1. Place the food onto the appropriate accessory in the cooking compartment and close the appliance door.
 2. Touch the  touch button.
 3. Set the type of heating and temperature.
 4. Touch the  touch button.
The time-setting options are shown in the display.
 5. Swipe to the left or right to select the cooking time.
 6. Touch " Ready at".
 7. Swipe to the left to select the end time.
 8. Touch the  touch button.
The appliance waits until the appropriate time to start the operation.

As soon as the end time has been reached, an audible signal sounds and the appliance ends the operation automatically. Touch the  touch button to end the audible signal.

Checking, changing or deleting settings



1. Touch the  field.
The time-setting options are shown on the display.
2. Touch the time-setting option.
3. If required, swipe to the left or right in the touch display to change the settings. To delete a time-setting option, set "-- : --".
The setting is applied automatically.

Childproof lock

Your appliance is equipped with a childproof lock so that children cannot switch it on accidentally or change any settings.

Your appliance has two different locks.





Lock	Activate/deactivate
Automatic childproof lock	Via the MyProfile menu → "Basic settings" on page 23
One-time childproof lock	Via the  touch button

Note: As soon as you activate the childproof lock, the control panel is locked. The  and  touch buttons are not included. You can deactivate the childproof lock at any time.



Automatic childproof lock

The control panel is locked so that the appliance cannot be switched on. To switch it on, the automatic childproof lock must be interrupted. After the appliance operation, the control panel is locked automatically.





Activation

1. Touch the  touch button.
2. Touch the  touch button.
3. Swipe to the left or right to select "MyProfile".
4. Touch the bottom line.
5. Swipe to the left or right to select the "Automatic childproof lock".
6. Touch the bottom line.
7. Swipe to the left or right to select "Activated".
8. Touch the  touch button.
9. Touch "Save".
The settings are saved. The automatic childproof lock is active. After the appliance is switched off, the  symbol appears in the display.

Cancelling

1. Press and hold the  touch button until "Childproof lock deactivated" appears on the display.
2. Touch the  touch button.
3. Switch on the required appliance operation.

Deactivation

1. Press and hold the  touch button until "Childproof lock deactivated" appears on the display.
2. Touch the  touch button.
3. Touch the  touch button.
4. Swipe to the left or right to select "MyProfile".
5. Touch the bottom line.
6. Touch the top line.
7. Swipe to the left or right to select the "Automatic childproof lock".
8. Touch the bottom line.
9. Swipe to the left or right to select "Deactivated".
10. Touch the  touch button.
11. Touch "Save".
The "Automatic childproof lock" is deactivated.
12. Touch the  touch button.

One-time childproof lock

The control panel is locked so that the appliance cannot be switched on. To switch it on, the one-time childproof lock must be deactivated. After the appliance is switched off, the control panel is no longer locked.

Activating and deactivating

1. Press and hold the ⊖ touch button until "Childproof lock activated" appears on the display.
The childproof lock is activated.
2. Press and hold the ⊖ touch button until "Childproof lock deactivated" appears on the display.
The childproof lock is deactivated.

Basic settings

There are various settings available to you in order to help use your appliance effectively and simply. If necessary, you can change these settings in MyProfile .

Changing MyProfile

1. Touch the ① touch button.
2. Touch the ⏏ touch button.
3. Swipe to the left or right to select "MyProfile .
4. Touch the bottom line.
5. Swipe to the left or right to select the required setting.
6. Touch the bottom line.
7. Swipe to the left or right to select the required setting.
8. Touch the ⏏ touch button.
9. Touch "Save".

List of basic settings





Setting	Selection
Language	Select language
Time of day	Sets the current time
Date	Sets the current date
Water hardness	0 (softened) 1 (soft) 2 (medium) 3 (hard) 4 (very hard)
Favourites	Set the heating types that should be shown in the heating types menu
Audible signal	Short duration Medium duration Long duration
Volume	Can be adjusted to one of five different levels
Button tone	Switched off (Exception: The button tone for the ① touch button remains switched on) Switched on
Display brightness	Adjustable across 5 levels
Clock display	Off Digital Analogue
Lighting	On during operation Off during operation
Childproof lock*	Only key lock Door lock and key lock
Automatic childproof lock	Deactivated Activated

Action after switching on	Main menu
	Heating types
	Steam
	Baking and roasting assistant
	Steam programmes
Night-time dimming	Switched off
	Switched on (display dimmed between 10 p.m. and 5.59 a.m.)
Brand name logo	Display
	Do not display
Fan run-on time	Recommended
	Minimum
Pull-out system*	Not retrofitted (rack)
	Retrofitted (single pull-out)
Factory settings	Restore
*) Depending on the appliance model, this basic setting cannot be selected	

Setting favourites

You can set which types of heating are shown in the Types of heating menu.

Note: The "CircoTherm hot air", "Circo-roasting" and "Grill, large area" types of heating are always shown in the Types of heating menu. They cannot be deactivated.

1. Touch the  touch button.
2. Touch the  touch button.
3. Swipe to the left or right to select "MyProfile .
4. Touch the bottom line.
5. Swipe to the left or right to select "Favourites".
6. Touch the bottom line.
7. Swipe to the left or right to select the required type of heating.
8. Touch "Activated" or "Deactivated".
9. Touch the  touch button.
10. Touch "Save".

Baking and roasting assistant

The baking and roasting assistant helps you to prepare meals with ease. The appliance applies the most suitable settings.

To achieve good results, the cooking compartment must not be too hot for the type of food you have selected. If it is, a message will appear on the display. Allow the cooking compartment to cool down and start again.

Information on the settings

- The cooking result depends on the quality of the food and the type of cookware. For an optimal cooking result, use food that is in good condition and chilled meat only.
- The baking and roasting assistant helps you to prepare classic cakes, bread and roasts. The appliance selects the optimal type of heating for you. It suggests a suitable temperature and cooking time, which you can change if you wish.
- Information is provided, e.g. on cookware, shelf position or the addition of liquid when cooking meat. Some food requires turning or stirring, etc. during cooking. This is shown in the display shortly after operation starts. An audible signal will remind you at the right time.
- Information on the right kind of cookware to use and tips and tricks for preparation can be found at the end of the instruction manual.

Selecting a meal



The following table shows the corresponding setting values for the listed meals.

Dishes
Sponge springform tin/loaf tin
Sponge (6 eggs)
Swiss roll
Yeast dough cake on baking sheet with dry topping
Plaited ring/loaf
Small baked puff-pastry items
Muffins, on one level
White bread in a loaf tin
Part-baked bread rolls/baguettes
Frozen pizza with thin base, 1 piece
Chips, frozen, on one level
Potato gratin, made from raw potatoes
Baked potatoes
Lasagne, fresh
Joint of pork, marbled, without rind
Meat loaf (1 kg)
Sirloin, medium (1.5 kg)
Beef pot roast

Dishes
Leg of lamb, boned
Chicken, whole
Chicken legs
Goose, whole (3-4 kg)

Selecting and setting food

You will be guided through the entire setting process for your chosen food.

1. Touch the  touch button to switch on the appliance.
2. Touch the  touch button.
3. Swipe to the left or right to select "Baking and roasting assistant".
4. Touch the bottom line.
5. Touch the required category.
6. Swipe to the left or right to select the required dish.
7. Touch the required dish.
The recommended settings appear on the display.

Note: For some meals, you can also display notes, e.g. on the shelf height and cookware. To do this, swipe to the left until all of the notes are displayed.

8. If required, you can change the recommended settings. To do this, touch "Adjust" in the bottom line. Touch the appropriate setting and adjust it.
9. Touch the  touch button to start the appliance operation.

As soon as the cooking time has elapsed, an audible signal sounds and the appliance ends the operation automatically. Touch the  touch button to end the audible signal.

Some recommended settings offer you the opportunity to continue cooking your dish.

If you are satisfied with the cooking result, touch "End".

If you are not happy with the cooking result, you can continue cooking your dish.

Continue cooking

1. Touch "Continue cooking".
2. If necessary, adjust the recommended setting.
3. Touch the  touch button to start "Continue cooking".

Cancelling

Press and hold the  touch button until the appliance operation is cancelled.

Switching off the appliance

Touch the  touch button to switch off the appliance.

Programmes

You can prepare food very easily using the various programmes. You select a programme and enter the weight of your food. The program then applies the most suitable settings.

To achieve good results, the cooking compartment must not be too hot for the type of food you have selected. If it is, a message will appear on the display. Allow the cooking compartment to cool down and start again.

Information on the settings

- The cooking result depends on the quality of the food and the type of cookware used. For best results, only use high-quality food and refrigerated meat. For frozen products, only use food directly from the freezer.
- For some dishes, you will be required to enter the weight. The appliance will then apply the time and temperature settings for you. It is not possible to set weights outside the intended weight range.
- For roasting programmes, for which the appliance applies the temperature selection, temperatures can be as high as 300 °C. Therefore ensure that you are using heat-resistant cookware.
- Information about cookware, shelf position or adding liquid for meat is provided for you. For some dishes, the food needs to be turned or stirred during cooking. This is shown briefly on the display after the start. A signal reminds you to do this at the right time.
- Information about suitable cookware and preparation tips and tricks can be found at the end of the instruction manual.

Steam

For the steam programme, the appliance provides you with programmes you can use to prepare your meals easily and professionally.

Information about the steam functions can be found in the relevant sections. → "Steam" on page 17

Warning – Risk of scalding!

When you open the appliance door, hot steam can escape. Steam may not be visible, depending on its temperature. When opening, do not stand too close to the appliance. Open the appliance door carefully. Keep children away.

Selecting a dish



The following table shows the corresponding setting values for the listed dishes.

Food
White bread, without a tin
Wheat bread, multi-grain wheat bread, without a tin
Wheat bread, multi-grain wheat bread in a loaf tin
Multi-grain rye bread with yeast in a loaf tin

Food
Flatbread
Plaited loaf, unfilled/savarin
Sponge cake
Joint of pork with crackling
Pork neck joint, boned
Smoked pork, boned/rolled joint
Fillet of beef, fresh, medium
Sirloin, fresh, medium
Sirloin, fresh, rare
Chicken, whole, fresh
Chicken portions, fresh
Chicken breast, steam
Goose, duck, unstuffed, fresh
Fish fillet, au gratin
Fish fillet, braise
Fish fillet, whole
Fish fillet, whole, steam
Cauliflower florets, steam
Broccoli florets, steam
Green beans, steam
Sliced carrots, steam
Vegetables, frozen
Unpeeled boiled potatoes, medium-sized
Basmati rice
Brown rice
Couscous
Lentils
Cooked side dishes, reheat
Chicken breast
Fish fillet, fresh
Yoghurt in glass jars
Rice pudding
Fruit compote
Eggs, soft-boiled
Eggs, hard-boiled
Bottles, sterilise

Setting a programme

You will be guided through the entire setting process for your chosen food.

1. Touch the  touch button to switch on the appliance.
2. Touch the  touch button.
3. Swipe to the left or right to select "Steam programmes".
4. Touch the bottom line.
5. Touch the required category.
6. Swipe to the left or right to select the required steam programme.
7. Touch the required steam programme.
The settings for this dish appear on the display.

Note: For some meals, you can also display notes, e.g. on the shelf height and cookware. To do this, swipe to the left until all of the notes are displayed.

8. If required, you adjust can set the weight for some meals. To do this, touch "Adjust" in the bottom line. Touch the appropriate setting and adjust it.
9. Touch the  touch button to start the appliance operation.
The estimated cooking time is shown.

Note: For some programmes, the displayed cooking time may change during the first few minutes, as the heating-up time depends on the temperature of the food and the water, amongst other things.

As soon as the cooking time has elapsed, an audible signal sounds and the appliance ends the operation automatically. Touch the  touch button to end the audible signal.

Some programmes offer you the opportunity to continue cooking your dish.

If you are satisfied with the cooking result, touch "End".

If you are not happy with the cooking result, you can continue cooking your dish.

Continue cooking

1. Touch "Continue cooking".
2. If necessary, adjust the recommended setting.
3. Touch the  touch button to start "Continue cooking".

Cancelling

Press and hold the  touch button until the appliance operation is cancelled.

Switching off the appliance

Touch the  touch button to switch off the appliance.

Meat thermometer

The MultiPoint meat thermometer makes precise cooking possible. It measures the temperature inside the food. Once the set temperature has been reached, the appliance automatically switches itself off.

Suitable types of heating

	Steaming
	CircoTherm hot air
	Top/bottom heating
	Circo-roasting
	Pizza setting
	Bread-baking
	Top/bottom heating eco
	CircoTherm eco
	Reheating

Notes

- The meat thermometer measures the temperature on the inside of the food between 30 °C and 99 °C.
- Use only the meat thermometer supplied. You can purchase it as a spare part from the after-sales service.
- After use, always remove the meat thermometer from the cooking compartment. Never store it inside the cooking compartment.

Inserting the meat probe into the food

Before placing your food into the cooking compartment, insert the meat probe into the food.

The meat probe has three measuring points. Ensure that the middle measuring point is inserted in the food.

Meat: For large pieces of meat, insert the meat probe at an angle from above as far as it will go into the meat. For relatively thin pieces of meat, insert the meat probe from the side at the thickest point.

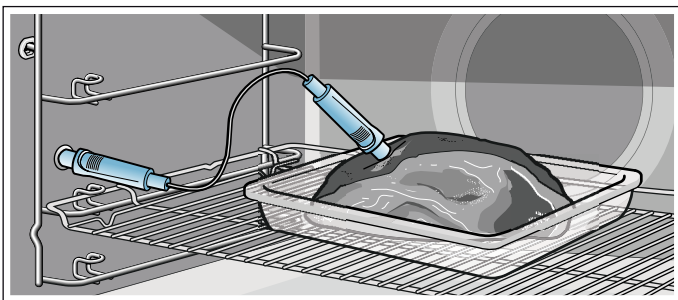

Poultry: Insert the meat probe as far as it will go into the thickest point in the breast. Insert the meat probe into the poultry crossways or lengthways depending on its structure. Then turn the poultry and place it on the wire rack breast-side down.

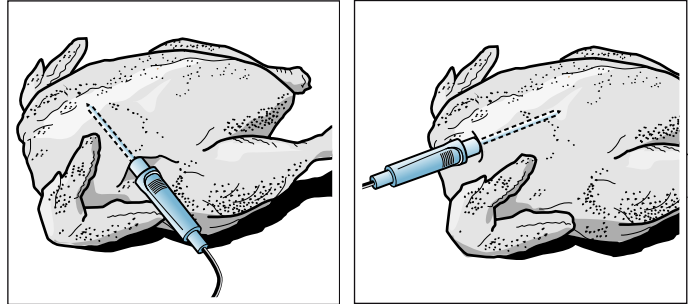

Fish: Insert the meat probe behind the head as far as it will go towards the spine. Place the whole fish onto the wire rack and prop it up in the swimming position using half a potato.

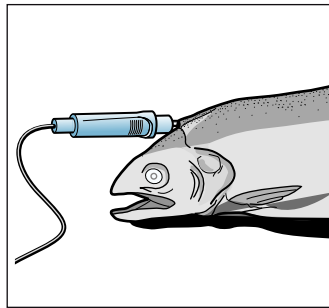

Turning the food: If you wish to turn the food, do not remove the meat probe. Once you have turned the food, check that the meat probe is correctly positioned in the food.

If you remove the meat probe while the food is cooking, all settings will be reset and you will have to apply them again.

Caution!

Ensure that the meat probe's cable does not become trapped.

To prevent the meat probe from being damaged by excessive heat, there must be a gap of a few centimetres between the grill element and the meat probe. The meat may expand during the cooking process.

Core temperatures of different foods

Do not use frozen food. The figures in the table are given as a guide. They depend on the quality and composition of the food.

You can find comprehensive information on the heating mode and temperature at the end of the instruction manual. → "Tested for you in our cooking studio" on page 38

Food	Core temperature in °C
Poultry	
Chicken	80-85
Chicken breast	75-80

Food	Core temperature in °C
Duck	80-85
Duck breast, medium rare	55-60
Turkey	80-85
Turkey breast	80-85
Goose	80-90
Pork	
Shoulder of pork	85-90
Fillet of pork, medium rare	62-70
Loin of pork, well done	72-80
Beef	
Tenderloin or sirloin, rare	45-52
Tenderloin or sirloin, medium rare	55-62
Tenderloin or sirloin, well done	65-75
Veal	
Joint of veal or shoulder, lean	75-80
Joint of veal, shoulder	75-80
Knuckle of veal	85-90
Lamb	
Leg of lamb, medium rare	60-65
Leg of lamb, well done	70-80
Saddle of lamb, medium rare	55-60
Fish	
Whole fish	65-70
Fish fillet	60-65
Miscellaneous	
Meat loaf, all kinds of meat	80-90
Heating/reheating food	65-75

Setting and starting the appliance operation

Warning – Risk of burns!

The cooking interior and the core temperature probe become very hot. Use oven mitts to plug and unplug the core temperature probe.

Warning – Risk of electric shock!

The insulation of an incompatible meat probe may be damaged. Only use the meat probe which is recommended for this appliance.

Notes



- The set cooking compartment temperature must be at least 10 °C higher than the core temperature.
- To prevent the meat thermometer from being damaged, the cooking compartment temperature must not be set higher than 250 °C.

1. Insert the meat thermometer in the socket on the left-hand side of the cooking compartment.
2. Close the appliance door.

Caution!

When doing so, ensure that the meat thermometer's cable is not trapped in the appliance door. It may be damaged.

3. Touch the  touch button.
4. Set the type of heating.

Note: When the meat thermometer is plugged into the socket, you can only select a type of heating with which the meat thermometer can be used.
5. Touch the cooking compartment temperature on the left in the bottom line.
6. Swipe to the left or right to select the required cooking compartment temperature.
7. Touch the  symbol to apply the setting.
8. Touch the  core temperature on the right in the bottom line.
9. Swipe to the left or right to select the required core temperature.
10. Touch the  touch button.
The appliance starts the operation.

Changing or cancelling the appliance operation



Changing the appliance operation

During appliance operation, you can change the cooking compartment temperature and core temperature.

1. Touch the cooking compartment temperature or core temperature twice.
2. Swipe to the left or right to change the temperature.
3. Touch the  symbol to apply the setting.

Stopping the appliance operation

Once the set core temperature has been reached, a signal sounds and the appliance stops the operation automatically.

1. Touch the  touch button to end the signal.
2. Use the  touch button to switch off the appliance.
3. Using an oven glove, unplug the meat thermometer from the socket.

Sabbath mode





You can set a time of up to 74 hours using Sabbath mode. The food in the cooking compartment remains warm, without you having to switch the appliance on or off.

Starting the Sabbath mode

Before you can use Sabbath mode, you must activate it under "Favourites" in the basic settings.

Once the Sabbath mode has been activated, you can select it under the menu for the types of heating.

The appliance heats up with top/bottom heating. The temperature can be set between 85 °C and 140 °C.

1. Touch the  touch button.
2. Swipe to the left or right to select the "Sabbath mode".
3. Touch the temperature in the bottom line.
4. Swipe to the left or right to select the required temperature.
5. Touch the  symbol to apply the setting.
6. Touch the  duration in the bottom line.
7. Swipe to the left or right to select the required duration.
8. Touch the  symbol to apply the setting.
9. Touch the  touch button.
The appliance starts the operation.

Notes

- Once Sabbath mode has started, you can no longer change any settings or cancel the operation using the  touch button.
- The operation is not interrupted if you open the appliance door.

Once the Sabbath mode duration has elapsed, a signal sounds. The appliance stops heating. Use the  touch button to switch off the appliance.

Canceling Sabbath mode

Touch the  touch button to cancel Sabbath mode.

Cleaning agent

With good care and cleaning, your appliance will retain its appearance and remain fully functioning for a long time to come. We will explain here how you should correctly care for and clean your appliance.

Suitable cleaning agents

To ensure that the different surfaces are not damaged by using the wrong cleaning agent, observe the information in the table. Depending on the appliance model, not all of the areas listed may be on/in your appliance.

Caution!

Risk of surface damage

Do not use:

- Harsh or abrasive cleaning agents,
- Cleaning agents with a high alcohol content,
- Hard scouring pads or cleaning sponges,
- High-pressure cleaners or steam cleaners,
- Special cleaners for cleaning the appliance while it is hot.

Wash new sponge cloths thoroughly before use.

Tip: Highly recommended cleaning and care products can be purchased through the after-sales service. Observe the respective manufacturer's instructions.

Warning – Risk of burns!

The appliance becomes very hot. Never touch the interior surfaces of the cooking compartment or the heating elements. Always allow the appliance to cool down. Keep children at a safe distance.

Area	Cleaning
Appliance exterior	
Stainless steel front	Hot soapy water: Clean with a dish cloth and then dry with a soft cloth. Remove flecks of limescale, grease, starch and albumin (e.g. egg white) immediately. Corrosion can form under such flecks. Special stainless steel cleaning products suitable for hot surfaces are available from our after-sales service or from specialist retailers. Apply a very thin layer of the cleaning product with a soft cloth.
Plastic	Hot soapy water: Clean with a dish cloth and then dry with a soft cloth. Do not use glass cleaner or a glass scraper.
Painted surfaces	Hot soapy water: Clean with a dish cloth and then dry with a soft cloth.
Control panel	Hot soapy water: Clean with a dish cloth and dry with a soft cloth. Do not use glass cleaner or a glass scraper. If descaler comes into contact with the control panel, wipe it off immediately. If you leave it, it may stain the control panel.

Door panels	Hot soapy water: Clean with a dish cloth and then dry with a soft cloth. Do not use a glass scraper or a stainless steel scouring pad.
Door handle	Hot soapy water: Clean with a dish cloth and then dry with a soft cloth. If descaler comes into contact with the door handle, wipe it off immediately. Otherwise, any stains will not be able to be removed.
Appliance interior	
Enamel surfaces and self-cleaning surfaces	Observe the instructions for the surfaces of the cooking compartment that follow the table.
Glass cover for the interior lighting	Hot soapy water: Clean with a dish cloth and then dry with a soft cloth. If the cooking compartment is heavily soiled, use oven cleaner.
Door seal Do not remove.	Hot soapy water: Clean with a dish cloth. Do not scour.
Door cover	made from stainless steel: Use stainless steel cleaner. Follow the manufacturers' instructions. Do not use stainless steel care products. made from plastic: Clean using hot soapy water and a dish cloth. Dry with a soft cloth. Do not use glass cleaner or a glass scraper. Remove the door cover for cleaning.
Rails	Hot soapy water: Soak and clean with a dish cloth or brush.
Pull-out system	Hot soapy water: Clean with a dish cloth or a brush. Do not remove the lubricant while the pull-out rails are pulled out – it is best to clean them when they are pushed in. Do not clean in the dishwasher.
Accessories	Hot soapy water: Soak and clean with a dish cloth or brush. Clean dirt on stainless steel roasting dishes caused by starchy foods (e.g. rice) using a vinegar solution.
Water tank	Hot soapy water: Clean with a dish cloth and rinse thoroughly to remove residual detergent. Then dry with a soft cloth. Leave the water tank to dry with the lid open. Rub the seal on the lid until dry. Do not clean in the dishwasher.
Meat thermometer	Hot soapy water: Clean with a dish cloth or a brush. Do not clean in the dishwasher.

Notes

- Slight differences in colour on the front of the appliance are caused by the use of different materials, such as glass, plastic and metal.
- Shadows on the door panels, which look like streaks, are caused by reflections made by the interior lighting.
- Enamel is baked on at very high temperatures. This can cause some slight colour variation. This is normal and does not affect operation. The edges of thin trays cannot be completely enamelled. As a result, these edges can be rough. This does not impair the anti-corrosion protection.

Surfaces in the cooking compartment

The back wall in the cooking compartment is self-cleaning. You can tell this from the rough surface.

The base, ceiling and side panel are enamelled and have smooth surfaces.

Cleaning enamelled surfaces

Clean the smooth enamelled surfaces with a dish cloth and hot soapy water or a vinegar solution. Then dry with a soft cloth.

Soften baked-on food residues with a damp cloth and soapy water. Use stainless steel wire wool or oven cleaner to remove stubborn dirt.

Leave the cooking compartment open to dry after cleaning.

Tip: Using the cleaning aid gives the best results.
→ "Cleaning function" on page 31

Note: Food residues can cause white deposits to form. These are harmless and do not affect how the appliance works. You can remove these residues using lemon juice if required.

Cleaning self-cleaning surfaces

The self-cleaning surfaces are coated with a porous, matte ceramic layer. This coating absorbs and dispels splashes from baking and roasting while the appliance is in operation.

If the self-cleaning surfaces no longer clean themselves sufficiently and dark stains appear, they can be cleaned using targeted heating.

Making settings

Remove the rails, pull-out shelves, accessories and ovenware from the cooking compartment beforehand. Thoroughly clean the smooth enamel surfaces in the cooking compartment, the inside of the appliance door and the glass cover on the interior lighting.

1. Set the type of heating for baking bread.
2. Set the maximum temperature.
3. Start the mode and leave it to run for at least one hour.

The ceramic coating is regenerated.

When the cooking compartment has cooled down, remove the brown or white residue with water and a soft sponge.

Note: During operation, reddish spots form on the surfaces. This is not rust, but residues from food. These spots are not harmful and do not restrict the cleaning ability of the self-cleaning surfaces.

Caution!

Do not use oven cleaner on the self-cleaning surfaces. This will damage the surfaces. If oven cleaner does get onto these surfaces, dab it off immediately using water and a sponge cloth. Do not rub the surface and do not use abrasive cleaning aids.

Keeping the appliance clean

Always keep the appliance clean and remove dirt immediately so that stubborn deposits of dirt do not build up.

Warning – Risk of fire!

Loose food remnants, fat and meat juices may catch fire. Before using the appliance, remove the worst of the food remnants from the cooking compartment, heating elements and accessories.

Tips

- Clean the cooking compartment after each use. This will ensure that dirt cannot be baked on.
- Always remove flecks of limescale, grease, starch and albumin (e.g. egg white) immediately.
- Use the universal pan for baking very moist cakes.
- Use suitable ovenware for roasting, e.g. a roasting dish.

Cleaning function

Your appliance is equipped with EasyClean and a descaling function. Use the EasyClean cleaning aid to clean the cooking compartment. Dirt is softened beforehand using EasyClean. It can then be removed more easily. You can use the descaling function to remove limescale from the evaporator.

EasyClean



The EasyClean cleaning aid makes it easier to clean the cooking compartment. Dirt is softened beforehand by vaporizing soapy water. It can then be removed more easily.





Warning – Risk of scalding!

Water in a hot cooking compartment may create hot steam. Never pour water into the hot cooking compartment.

Starting

Notes

- The "EasyClean " cleaning aid can only be started once the cooking compartment is cold (room temperature) and the appliance door is closed.
- Do not open the appliance door during operation. Doing this will interrupt the "EasyClean " cleaning aid.

1. Remove the accessories from the cooking compartment.
2. Mix a drop of washing-up liquid into 0.4 litres of water (do not use distilled water) and pour it onto the centre of the cooking compartment floor.
3. Touch the  touch button.
4. Touch the  touch button.
5. Swipe to the left or right to select "EasyClean ".
6. Touch the bottom line.
7. Touch the  touch button.
The appliance starts EasyClean. The remaining time appears on the display.

Finishing

As soon as the cleaning aid has finished, an audible signal sounds and the appliance ends the operation automatically.

As soon as you open the appliance door, the interior lighting is switched on so that you can finish cleaning the cooking compartment more easily. The remaining water in the cooking compartment must be removed promptly. Do not leave the remaining water in the cooking compartment for a long time (e.g. overnight). The appliance must not be operated when the cooking compartment is still wet or damp.

Final cleaning

1. Open the appliance door and remove the remaining water with an absorbent sponge cloth.
2. Clean the smooth surfaces in the cooking compartment with a dish cloth or a soft brush. Stubborn residues can be removed using a stainless steel scouring pad.

3. Remove limescale with a cloth soaked in vinegar. Then wipe with clean water and rub dry with a soft cloth (including under the door seal).
4. Use the  touch button to switch off the appliance.
5. Leave the appliance door ajar in the locking position (approx. 30°) for approx. 1 hour to allow the enamel surfaces in the cooking compartment to dry. Alternatively, you can also run the rapid drying function for the cooking compartment.

Running the rapid drying function for the cooking compartment

1. After the cleaning aid process has finished, leave the appliance door ajar in the locking position (approx. 30°).
2. Touch the  touch button.
3. Start CircoTherm hot air at 50 °C.
4. After 5 minutes, switch off the appliance and close the appliance door.

Removing heavy deposits of dirt

You have several options for removing particularly stubborn deposits of dirt.

- Leave the soapy water to work for some time before starting the cleaning aid.
- Rub soapy water onto the dirt on the smooth surfaces before starting the cleaning aid.
- Repeat the cleaning aid once the cooking compartment has cooled down.

Descaling

The appliance must be descaled regularly in order for it to continue operating correctly.

There are several steps in the descaling programme. For hygiene reasons, the descaling programme must be run through completely so that the appliance can be ready for operation again. In total, the descaling programme runs for approx. 70-90 minutes.

- Descale (approx. 55-70 minutes), then empty and refill the water tank
- First rinsing cycle (approx. 6-9 minutes), then empty and refill the water tank
- Second rinsing cycle (approx. 6-9 minutes), then empty and dry the water tank

If the descaling process is interrupted (for example, due to a power failure or because the appliance has been switched off), you are prompted to rinse the appliance twice after it is switched back on. The appliance cannot be used until the second rinsing cycle has come to an end.





The frequency with which the appliance must be descaled depends on the hardness of the water used. When only five more steam-assisted operations are possible, or fewer, the appliance reminds you to descale it with a message on the display. The number of remaining operations is displayed after the appliance is switched on. You can therefore prepare for the descaling in good time.

Starting

Caution!

- Risk of damage to the appliance: Only use liquid descalers recommended by us for the descaling programme. The time the product needs to work during descaling depends on the type of descaler used. Other descalers may damage the appliance. Descaler order no. 311 680
- Descaling solution: Do not allow any descaling solution or descaler to come into contact with the control panel or other surfaces on the appliance. This damages the surfaces. If this does happen, remove the descaling solution immediately with water.

If you have used a steam-assisted operation immediately before descaling, you must first switch the appliance off so that the residual water is pumped out of the evaporator system.

1. Mix 400 ml water with 200 ml liquid descaler to make a descaling solution.
2. Touch the  touch button.
3. Remove the water tank and fill it with descaling solution.
4. Once the water tank has been filled with descaling solution, push it back in again fully.
5. Close the control panel.
6. Touch the  touch button.
7. Swipe to the left or right to select "Descal" .
8. Touch the bottom line.
The duration of the descaling programme is displayed. It cannot be changed.
9. Touch the bottom line.
10. Touch the  touch button.
The appliance is now descaled. The remaining time counts down on the display. As soon as the descaling programme has finished, an audible signal sounds.

First wash cycle

1. Open the control panel.
2. Remove the water tank, rinse thoroughly, fill with water and reinsert.
3. Close the control panel.
4. Touch the  touch button.
The appliance is rinsed. As soon as the wash cycle has finished, an audible signal sounds.

Second wash cycle

1. Open the control panel.
2. Remove the water tank, rinse thoroughly, fill with water and reinsert.
3. Close the control panel.
4. Touch the  touch button.
The appliance is rinsed. As soon as the wash cycle has finished, an audible signal sounds.

Final cleaning

1. Open the control panel.
2. Empty and dry the water tank.
3. Switch off the appliance.
Descaling is complete and the appliance is ready for use again.

Rails

With good care and cleaning, your appliance will retain its appearance and remain fully functional for a long time to come. This will tell you how to remove the shelves and clean them.

Changing the shelf position for the telescopic rail

Bars and telescopic rails can be positioned in any order. For example, you can fit the telescopic rail to the shelf position which you use the most frequently.

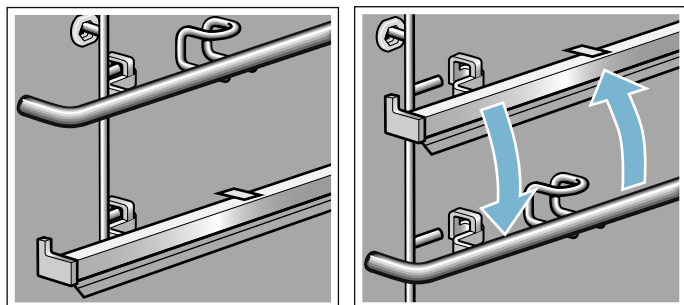

Removing the bar

Telescopic rails are removed and fitted like bars.

1. Push the bar towards the back **a** until it can be pulled out upwards **b** (Fig. **1**).
2. Unhook the bar at the back and remove it (Fig. **2**).

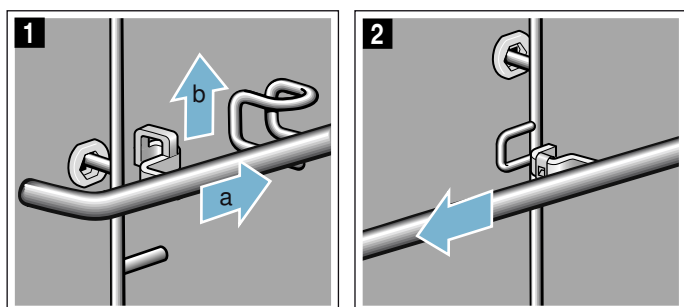

Fitting the bar

1. Fit the bar at the back (Fig. **1**).

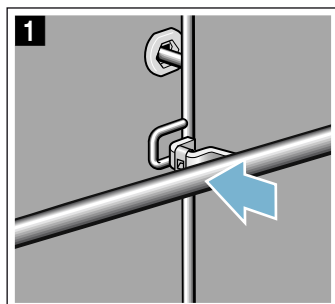

2. Push the bar towards the back **a** and down **b** onto the pin **c** (Fig. **2**).
3. Ensure that the hook is hooked onto the pin **c** (Fig. **3**).

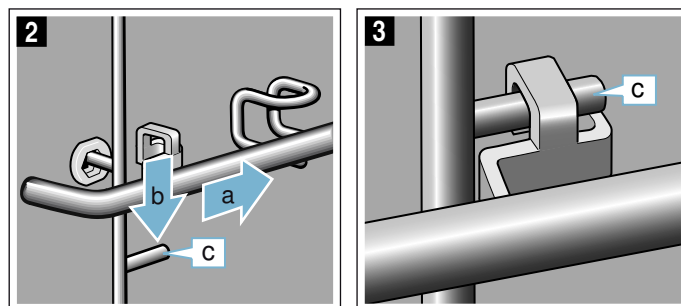

Detaching and refitting the rails

⚠ Warning – Risk of burns!

The rails become very hot. Never touch the hot rails. Always allow the appliance to cool down. Keep children away from the appliance.

Detaching the rails

1. Lift the rail slightly at the front **a** and detach it **b** (do not hold by the accessory holders or the telescopic shelf) (figure **1**).
2. Then pull the whole rail towards you and take it out (figure **2**).

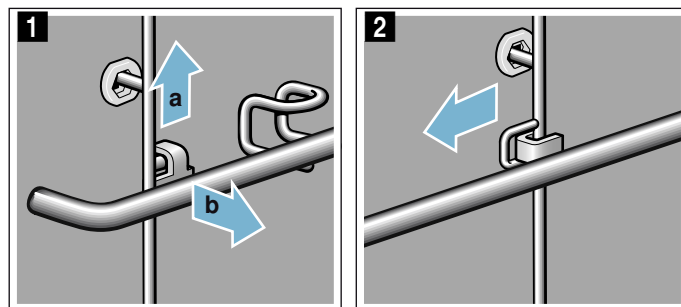

Clean the rails with cleaning agent and a sponge. For stubborn deposits of dirt, use a brush.

Attaching the rails

The rails only fit on the right or the left side. The pull-out rails must pull out towards you.

1. First, insert the rail in the middle of the rear socket **a**, until the rail rests against the cooking compartment wall, and push it back **b** (figure **1**).
2. Then insert the rail into the front socket **c**, until the rail also rests against the cooking compartment wall here, and press it downwards **d** (figure **2**).

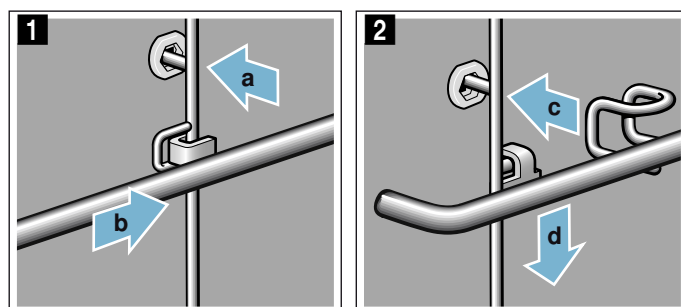

Appliance door

With good care and cleaning, your appliance will retain its appearance and remain fully functioning for a long time to come. This will tell you how to clean the appliance door.

Removing and installing the door panels

To facilitate cleaning, you can remove the glass panels from the appliance door.

Removal

Warning – Risk of injury!

Components inside the appliance door may have sharp edges. Wear protective gloves.

1. Open the appliance door approx. 45° and wedge a tea towel in the appliance door to ensure that it stays open (fig. 1).
2. Loosen and remove the screws on the left and right of the appliance door (figure 2).

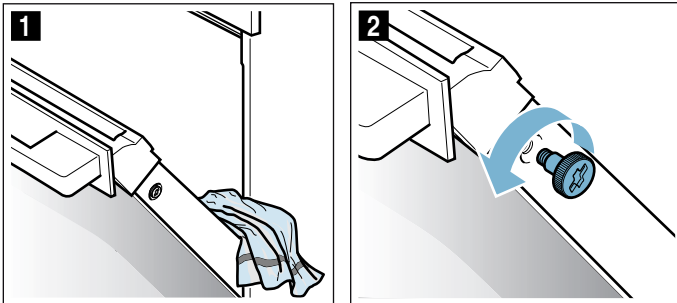

3. Take hold of the bottom of the front panel on both sides (fig. 3) and push it upwards until it is released (fig. 4).

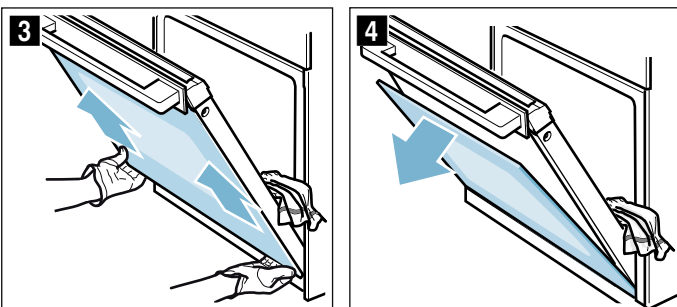

Warning **Risk of injury!**

The gap between the lower edge of the front panel and the cupboard changes when the door is opened; be careful not to catch your fingers. Open the door carefully.

Note: If you are unable to release the front panel, check whether the front panel is touching the handle. If it is, use one hand to open the appliance door a little further until the front panel is released.

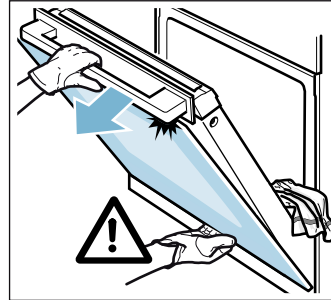

Note: If you are unable to release the front panel, use one hand to take hold of the top edge of the front panel and pull it in the direction of the arrow until it is released.

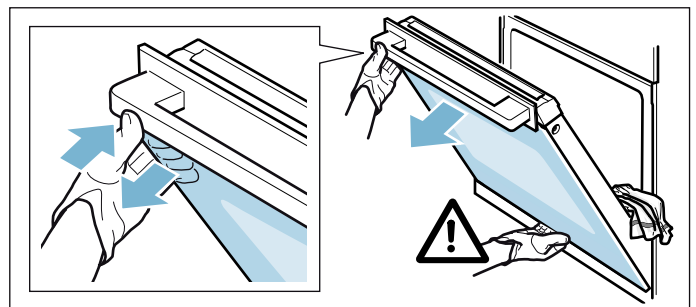

4. Remove the front panel (fig. 5).

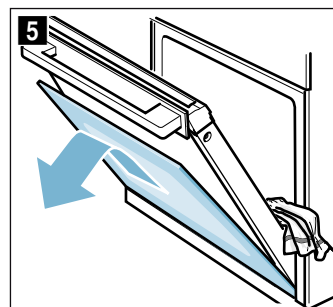

5. Place the front panel on a soft, flat surface.

Warning **Risk of injury!**

Scratched glass in the appliance door may develop into a crack. Do not use a glass scraper, or sharp or abrasive cleaning aids or detergents.

Warning **Risk of injury!**

The hinges on the appliance door move when opening and closing the door, and you may be trapped. Keep your hands away from the hinges.

6. Clean the panels with glass cleaner and a soft cloth.

Installation

1. Open the appliance door approx. 45° and wedge a tea towel in the appliance door to ensure that it stays open.
2. Hang the front panel in at the bottom left and right (fig. **1**).
3. Press down on the front panel and slide it upwards until it clicks into place. Make sure that the hooks on the left and right engage (fig. **2**).

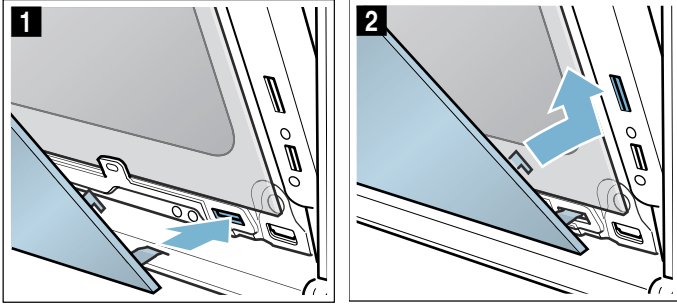

Tip: If you are unable to click the front panel into place, check whether the front panel is touching the handle. Open the door a little further until the front panel clicks into place.

4. Screw both screws back in on the left and right of the appliance door.
5. Remove the tea towel from the oven door.
6. Close the appliance door.

Caution!

Do not use the cooking compartment again until the panels have been correctly fitted.

Trouble shooting

If a fault occurs, there is often a simple explanation. Before calling the after-sales service, please refer to the fault table and attempt to correct the fault yourself.

Tip: If a meal does not turn out exactly as you wanted, refer to the "Tested for you in our cooking studio" section. Here, you will find plenty of cooking tips and notes.

Fault table









 **Warning – Risk of electric shock!**

- Work on the appliance electronics may only be performed by a specialist.
- Always disconnect the appliance from the power supply when work is carried out on the electronics. Switch off the circuit breaker or remove the fuse from your household fuse box.

 **Warning – Risk of electric shock!**

Incorrect repairs are dangerous. Repairs may only be carried out and damaged power cables replaced by one of our trained after-sales technicians. If the appliance is defective, unplug the appliance from the mains or switch off the circuit breaker in the fuse box. Contact the after-sales service.

Fault	Possible cause	Notes/remedy
The appliance does not work	The plug is not plugged into the mains	Connect the appliance to the power supply
	Power cut	Check whether other kitchen appliances are working
	The circuit breaker is faulty	Check in the fuse box to make sure that the fuse for the appliance is OK
Operations with steam or descaling do not start or do not continue	Water tank empty	Refill water tank
	The panel is open	Close the panel
	Descaling locks operations with steam	Carry out descaling
	Faulty sensor	Call the after-sales service
After switching on an operating mode, a message is shown on the display which indicates that the temperature is too high	The appliance has not cooled down sufficiently	Allow the appliance to cool down and switch the operating mode on again
The appliance prompts you to rinse	The power supply was interrupted or the appliance was switched off during the descaling process	Once the appliance is switched on again, rinse it twice
The appliance prompts you to descale without the counter appearing beforehand	The set water hardness range is too low	Carry out descaling Check the set water hardness range and adjust it, if necessary
Buttons flash	Normal occurrence caused by condensation behind the control panel	As soon as the condensation has evaporated, the buttons no longer flash
Cooked dishes turn out too moist or too dry when cooking with steam-assisted applications	The wrong steam intensity was selected	Select a higher or lower steam intensity
The "Fill water tank" message appears even though the water tank is full	The panel is open	Close the panel
	The water tank is not clicked into place	Click the water tank into place → "Steam" on page 17
	Faulty sensor	Call the after-sales service
	The water tank has fallen off. Due to the impact, components inside the water tank have come loose, and the tank is leaking.	Order a new water tank

The panel for removing the tank does not open	The plug is not plugged into the mains	Connect the appliance to the power supply
	Power cut	Check whether other kitchen appliances are working
	The circuit breaker is faulty	Check in the fuse box to make sure that the fuse for the appliance is OK
	Faulty sensor for the  touch button	Call the after-sales service If required, empty the water tank: Open the appliance door, take hold of the lower part of the panel on the left and right with your fingers and pull out the panel
Steam escapes from the ventilation slots during cooking	Normal procedure	Not possible
When you cook with steam, a lot of steam is produced	The appliance is being automatically calibrated	Normal procedure
When cooking with steam, a lot of steam is produced repeatedly	The appliance is unable to calibrate itself automatically if cooking times are too short	Reset the appliance to the factory settings and repeat the calibration process
The appliance cannot be switched on; the  symbol is shown on the display	The automatic childproof lock is activated	Press and hold the  touch button until the  symbol goes out
The appliance cannot be operated when it is switched on; the  symbol is shown on the display	The childproof lock is activated	Press and hold the  touch button until the  symbol goes out
The appliance does not heat up;  is shown on the display	Demo mode is activated in the basic settings	Disconnect the appliance from the mains for approx. 10 seconds (switch off the circuit breaker in the fuse box) and then deactivate demo mode in the basic settings within 3 minutes → "Basic settings" on page 23
There is a "pop" noise during cooking	Cold/warm effect with frozen food, caused by the steam	Not possible
"EXXX" appears on the display, e.g. "E0111"	Technical problem	Switch the appliance off and back on again If the message appears again, call the after-sales service

Maximum operating time exceeded

Your appliance ends the operation automatically when no cooking time is set and the setting has not been changed for a long time.

The actual cooking time until the operation is stopped automatically varies according to the selected settings.

The appliance display indicates that the operation will end automatically. Afterwards, the operation is stopped.

To use the appliance again, switch it off beforehand. Then switch the appliance on again and set the required operation.

Cooking compartment bulbs

To light the interior of your cooking compartment, your appliance has one or more long-life LED bulbs.

However, if ever an LED bulb or the bulb's glass cover is defective, call the after-sales service. The lamp cover must not be removed.

Customer service

Our after-sales service is there for you if your appliance needs to be repaired. We will always find an appropriate solution, also in order to avoid after-sales personnel having to make unnecessary visits.

E number and FD number

When calling us, please give the full product number (E no.) and the production number (FD no.) so that we can provide you with the correct advice. The rating plate bearing these numbers can be found on the right-hand side when you open the fascia panel. Touch the  touch button to do this. → "Steam" on page 17

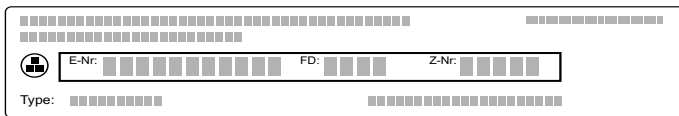

To save time, you can make a note of the number of your appliance and the telephone number of the after-sales service in the space below, should it be required.

E no.	FD no.

After-sales service

Please note that there will be a fee for a visit by a service technician in the event of a malfunction, even during the warranty period.

Please find the contact data of all countries in the enclosed customer service list.

To book an engineer visit and product advice

GB 0344 892 8989

Calls charged at local or mobile rate.

IE 01450 2655

0.03 € per minute at peak. Off peak 0.0088 € per minute.

Rely on the professionalism of the manufacturer. You can therefore be sure that the repair is carried out by trained service technicians who carry original spare parts for your appliances.

Tested for you in our cooking studio

Here, you can find a selection of dishes and the ideal settings for them. We will show you which type of heating and temperature are best suited to your dish. You will get information on suitable cooking accessories and the height at which they should be placed in the oven. You will also get tips about cookware and preparation methods.

Note: A lot of steam can build up in the cooking compartment when cooking food.

Your appliance is very energy-efficient and radiates very little heat to its surroundings during operation. Due to the high difference in temperature between the appliance interior and the external parts of the appliance, condensation may build up on the door, control panel or adjacent kitchen cabinet panels. This is a normal physical phenomenon. Condensation can be reduced by preheating the oven or opening the door carefully.

When steaming or during operation with steam assistance, it is desirable that there is a significant build-up of steam in the cooking compartment. Wipe the cooking compartment clean after cooking, once it has cooled off.

Silicone moulds

For the best cooking results, we recommend dark-coloured metal baking tins/dishes.

Nevertheless, if you wish to use silicone moulds, follow the manufacturer's instructions and recipes. Silicone moulds are often smaller than normal baking tins. Quantity and recipe specifications may vary.

Silicone moulds are unsuitable for steam-assisted cooking and steaming.

Cakes and small baked items

Your appliance offers you a range of heating types for the preparation of cakes and small baked items. You can find the ideal settings for many dishes in the settings tables.

Also refer to the notes in the section on allowing dough to rise.

Only use original accessories supplied with your appliance. These have been tailored to the cooking compartment and the operating modes of your appliance.

Steam-assisted baking

Certain types of baked item (e.g. yeast-risen pastries) get a more crispy crust and a more glossy surface if baked with the steam assist mode. The baked item does not dry out as much.

Steam-assisted baking is only possible on one level.

Some food turns out better if it is baked in several stages. These dishes are indicated in the table.

Shelf positions

Use the indicated shelf positions.

Baking on one level

When baking on one level, use the following shelf position:

- Level 1

Baking on two levels

Use CircoTherm. Baked items that are placed into the oven on trays or in baking tins/dishes at the same time will not necessarily be ready at the same time.

- Universal pan: Level 3
Baking tray: Level 1
- Baking tins/dishes on the wire rack
First wire rack: Level 3
Second wire rack: Level 1

By preparing several dishes at the same time, you can make energy savings of up to 45 per cent. Position baking tins/dishes next to one another or offset and vertically stacked in the cooking compartment.

Accessories

Ensure that you always use suitable accessories and that they are placed in the oven the right way around.

Wire rack

Insert the wire rack with the open side facing the appliance door and the curved lip pointing downwards. Always place ovenware, tins and dishes on the wire rack.

Universal pan or baking tray

Slide the universal pan or the baking tray in carefully as far as the limit stop with the bevelled edge facing the appliance door.

When baking moist cakes or pastries with many toppings, use the universal pan so that any excess liquid does not overflow and make the cooking compartment dirty.

Baking tins

Dark- coloured metal baking tins are most suitable.

Tinplate baking tins, ceramic dishes and glass dishes extend baking time and mean that the baked item will not brown evenly.

The baking tins must be resistant to heat and steam for use in steam-assisted baking.

Greaseproof paper

Only use greaseproof paper that is suitable for the selected temperature. Always cut greaseproof paper to size.

Recommended setting values

The table lists the optimal heating type for various baked items. The temperature and baking time depend on the amount and consistency of the dough/mixture. For this reason, the table specifies setting ranges. Try using the lower values to start with. A lower temperature will result in more even browning. You can use a higher setting next time if necessary.

Note: Baking times cannot be reduced by using higher temperatures. Cakes or small baked items would only be cooked on the outside, and would not be fully baked in the middle.





The setting values apply to food that is placed into a cold cooking compartment; by doing this, you can make energy savings of up to 20 per cent. If you preheat the oven, you can reduce the indicated baking times by several minutes.

Preheating is necessary for selected food, and this is indicated in the table. Do not place your food or accessories into the cooking compartment until it has finished preheating.

If you wish to follow one of your own recipes when baking, you should use the setting values listed for similar baked items in the table as reference. Additional information can be found in the baking tips listed after the settings table.





Remove unused accessories from the cooking compartment. This will ensure that you achieve the best possible cooking results and energy savings of up to 20 per cent.

Types of heating used:

-  CircoTherm
-  Top/bottom heating
-  Circotherm intensive
-  Bread baking

The levels of steam intensity are indicated as numbers in the table:

- 1 = Low
- 2 = Medium
- 3 = High

Dish	Accessories/cookware	Shelf position	Heating function	Temperature in °C	Steam intensity	Cooking time in mins.
Cakes in tins						
Sponge cake, simple	Ring tin/cake tin	1		150-170	-	55-70
Sponge cake, simple	Ring tin/cake tin	1		150-160	1	50-70
Sponge cake, delicate	Ring tin/cake tin	1		150-170	-	60-80
Fruit flan made from sponge mixture, delicate	Ring/springform cake tin	1		160-180	-	45-60
* Preheat						
** Preheat for 5 mins., do not use quick heat function						

Dish	Accessories/cookware	Shelf position	Heating function	Temperature in °C	Steam intensity	Cooking time in mins.
Fruit flan made from sponge mixture, delicate	Ring/springform cake tin	1		150-170	-	45-60
Sponge flan base	Flan base tin	1		150-170	-	20-40
Sponge flan base	Flan base tin	2		160-170	1	25-35
Fruit tart or cheesecake with shortcrust pastry base	Springform cake tin, Ø 26 cm	1		170-180	-	60-80
Swiss flan	Pizza tray	1		190-210	-	40-55
Swiss flan	Pizza tray	1		180-200	-	40-50
Tart	Flan-base cake tin, black	1		190-210	-	25-40
Tart	Flan-base cake tin, black	1		210-220	1	30-40
Bundt yeast cake	Ring cake tin	1		150-160	-	65-75
Bundt yeast cake	Ring cake tin	1		150-160	1	60-70
Yeast cake in springform cake tin	Springform cake tin, Ø 28 cm	1		150-160	-	25-35
Yeast cake in springform cake tin	Springform cake tin, Ø 28 cm	1		160-170	2	25-35
Sponge base, 2 eggs	Flan base tin	1		170-180	-	20-30
Sponge base, 2 eggs	Flan base tin	1		150-160	1	25-35
Sponge flan, 3 eggs	Springform cake tin, Ø 26 cm	1		160-170*	-	25-35
Sponge flan, 3 eggs	Springform cake tin, Ø 26 cm	1		150-160	1	10
					-	20-30
Sponge flan, 6 eggs	Springform cake tin, Ø 28 cm	1		150-170*	-	30-50
Sponge flan, 6 eggs	Springform cake tin, Ø 28 cm	1		150-160	1	10
					-	25-35
Cakes on baking trays						
Sponge cake with topping	Baking tray	1		160-180	-	20-40
Sponge cake with topping	Baking tray	1		160-170	1	30-40
Sponge cake, 2 levels	Universal pan + baking tray	3+1		150-170	-	35-50
Shortcrust tart with dry topping	Baking tray	1		170-190	-	25-40
Shortcrust tart with dry topping, 2 levels	Universal pan + baking tray	3+1		150-170	-	40-55
Shortcrust tart with moist topping	Universal pan	1		160-180	-	60-80
Swiss flan	Universal pan	1		180-200	-	40-50
Swiss flan	Universal pan	1		190-210	-	40-50
Yeast cake with dry topping	Baking tray	1		160-180	-	15-25
Yeast cake with dry topping	Baking tray	1		150-160	1	25-35
Yeast cake with moist topping	Universal pan	1		180-200	-	30-45
Yeast cake with moist topping	Universal pan	1		160-180	-	50-70
Yeast cake with dry topping, 2 levels	Universal pan + baking tray	3+1		160-170	-	25-35
Yeast cake with moist topping, 2 levels	Universal pan + baking tray	3+1		150-160	-	45-60
Plaited loaf, savarin	Baking tray	1		150-160	-	35-45
Plaited loaf, savarin	Baking tray	1		150-170	2	30-40
Swiss roll	Baking tray	1		190-210*	-	10-15
Swiss roll	Baking tray	1		190-210*	1	10-15
Stollen with 500 g flour	Universal pan	1		150-160	-	50-60
Stollen with 500 g flour	Universal pan	1		140-150	2	80-90
Strudel, sweet	Universal pan	1		170-180	-	40-60
* Preheat						
** Preheat for 5 mins., do not use quick heat function						

Dish	Accessories/cookware	Shelf position	Heating function	Temperature in °C	Steam intensity	Cooking time in mins.
Strudel, sweet	Universal pan	1		180-190	2	50-60
Strudel, frozen	Universal pan	1		190-210	-	35-50
Strudel, frozen	Universal pan	1		180-190	1	35-45
Small baked items						
Small cakes	Baking tray	1		160**	-	25-35
Small cakes	Baking tray	1		150**	-	25-35
Small cakes, 2 levels	Universal pan + baking tray	3+1		150**	-	25-35
Muffins	Muffin tray	1		170-190	-	15-30
Muffins	Muffin tray	1		150-160	1	25-30
Muffins, 2 levels	Muffin trays	3+1		150-170*	-	20-30
Small yeast cakes	Baking tray	1		160-170	-	30-40
Small yeast cakes	Baking tray	1		160-180	2	25-35
Puff pastry	Baking tray	2		170-190*	-	20-45
Puff pastry	Baking tray	1		200-220*	1	15-25
Puff pastry, 2 levels	Universal pan + baking tray	3+1		170-190*	-	20-45
Choux pastry	Baking tray	1		200-220	-	30-45
Choux pastry	Baking tray	1		200-220*	1	25-35
Danish pastry	Baking tray	1		160-180	-	20-30
Danish pastry	Baking tray	1		160-180	2	25-35
Biscuits						
Viennese whirls	Baking tray	1		150-160**	-	25-40
Viennese whirls	Baking tray	1		140-150**	-	25-40
Whirls, 2 levels	Universal pan + baking tray	3+1		140-150**	-	30-40
Biscuits	Baking tray	2		140-160	-	15-30
Biscuits, 2 levels	Universal pan + baking tray	3+1		130-150	-	20-35
Meringue	Baking tray	2		90-100*	-	100-130
Meringue, 2 levels	Universal pan + baking tray	3+1		90-100*	-	100-150
Macaroons	Baking tray	2		90-110	-	20-40
Macaroons, 2 levels	Universal pan + baking tray	3+1		90-110	-	20-40
* Preheat						
** Preheat for 5 mins., do not use quick heat function						

Tips on baking

You want to find out whether the cake is completely cooked in the middle.	Push a cocktail stick into the highest point on the cake. If the cocktail stick comes out clean with no dough residue, the cake is ready.
The cake collapses.	Next time, use less liquid. Alternatively, set the temperature to be 10 °C lower and extend the baking time. Adhere to the specified ingredients and preparation instructions in the recipe.
The cake has risen in the middle but is lower around the edge.	Only grease the base of the springform cake tin. After baking, loosen the cake carefully with a knife.
The fruit juice overflows.	Next time, use the universal pan.
Small baked items stick to one another during baking.	There should be a gap of approx. 2 cm around each item. This gives enough space for the baked items to expand well and brown on all sides.
The cake is too dry.	Set the temperature 10 °C higher and shorten the baking time.
The cake is generally too light in colour.	If the shelf position and the cookware are correct, then you should increase the temperature if necessary or extend the baking time.
The cake is too light on top, and too dark underneath.	Bake the cake one level higher in the oven the next time.

The cake is too dark on top, and too light underneath.	Bake the cake one level lower in the oven the next time. Select a lower temperature and extend the baking time.
Cakes baked in a tray or tin are too brown at the back.	Place the baking tray in the middle of the accessories, not directly against the back wall.
The whole cake is too dark.	Select a lower temperature next time and extend the baking time if necessary.
The cake is unevenly browned.	Select a slightly lower temperature. Protruding greaseproof paper can affect the air circulation. Always cut greaseproof paper to size. Ensure that the baking tin does not stand directly in front of the openings in the cooking compartment back wall. When baking small items, you should use similar sizes and thicknesses wherever possible.
You were baking on several levels. The items on the top baking tray are darker than those on the lower baking tray.	Always use CircoTherm when baking on several levels. Baked items that are placed into the oven on trays or in baking tins/dishes at the same time will not necessarily be ready at the same time.
The cake looks good, but is not cooked properly in the middle.	Use a lower temperature and bake slightly longer; if necessary, add slightly less liquid. For cakes with a moist topping, bake the base first. Sprinkle it with almonds or breadcrumbs and then place the topping on top.
The cake cannot be turned out of the dish when it is turned upside down.	Allow the cake to cool down for 5 to 10 minutes after baking. If it still sticks, carefully loosen the cake around the edges again using a knife. Turn the cake tin upside down again and cover it several times with a cold, wet cloth. Next time, grease the baking tin/dish and sprinkle with breadcrumbs.

Bread and rolls

Your appliance offers you a range of heating types for baking bread and rolls. You can find the ideal settings for many dishes in the settings tables.

Also refer to the notes in the section on allowing dough to rise.

Only use original accessories supplied with your appliance. These have been tailored to the cooking compartment and the operating modes of your appliance.

Steam- assisted baking

Bread and bread rolls get a more crispy crust and a more glossy surface if baked with the steam assist mode. The baked item does not dry out so much.

Steam-assisted baking is only possible on one level.

Shelf positions

Use the indicated shelf positions.

Baking on one level

When baking on one level, use the following shelf position:

- Level 1

Baking on two levels

Use CircoTherm. Baked items that are placed into the oven on trays or in baking tins/dishes at the same time will not necessarily be ready at the same time.

- Universal pan: Level 3
Baking tray: Level 1
- Baking tins/dishes on the wire rack
First wire rack: Level 3
Second wire rack: Level 1

By preparing several dishes at the same time, you can make energy savings of up to 45 per cent. Position baking tins/dishes next to one another or offset and vertically stacked in the cooking compartment.

Accessories

Ensure that you always use suitable accessories and that they are placed in the oven the right way around.

Wire rack

Insert the wire rack with the open side facing the appliance door and the curved lip pointing downwards. Always place ovenware, tins and dishes on the wire rack.

Universal pan or baking tray

Slide the universal pan or the baking tray in carefully as far as the limit stop with the bevelled edge facing the appliance door.

Baking tins

Dark- coloured metal baking tins are most suitable.

Tinplate baking tins, ceramic dishes and glass dishes extend baking time and mean that the baked item will not brown evenly.

The baking tins must be resistant to heat and steam for use in steam-assisted baking.

Greaseproof paper

Only use greaseproof paper that is suitable for the selected temperature. Always cut greaseproof paper to size.

Frozen products

Do not use frozen products that are heavily frosted. Remove any ice on the food.

Some frozen products may be unevenly pre-baked. Uneven browning may remain even after baking.

Recommended setting values

The table lists the optimal heating type for various kinds of bread and bread roll. The temperature and baking time depend on the amount and consistency of the dough/mixture. For this reason, the table specifies setting ranges. Try using the lower values to start with. A lower temperature will result in more even browning. You can use a higher setting next time if necessary.

Note: Baking times cannot be reduced by using higher temperatures. The bread or bread rolls would only be cooked on the outside, but would not be fully baked in the middle.

The setting values apply to food that is placed into a cold cooking compartment; by doing this, you can make energy savings of up to 20 per cent. If you preheat the oven, you can reduce the indicated baking times by several minutes.

Preheating is necessary for selected food, and this is indicated in the table. Do not place your food or accessories into the cooking compartment until it has finished preheating. Some food turns out best if it is baked in several stages. These foods are indicated in the table.

The setting values for bread dough apply to both dough placed on a baking tray and dough placed in a loaf tin.

If you wish to follow one of your own recipes when baking, you should use the setting values listed for similar baked items in the table as reference.

Remove unused accessories from the cooking compartment. This will ensure that you achieve the best possible cooking results and energy savings of up to 20 per cent.

Caution!















Never pour water into the hot cooking compartment or place cookware containing water onto the bottom of the cooking compartment. The change in temperature can cause damage to the enamel.

Types of heating used:

-  CircoTherm
-  Top/bottom heating
-  Circo-roasting
-  Circotherm intensive
-  Bread baking
-  Full-surface grill
-  Centre-area grill

The levels of steam intensity are indicated as numbers in the table:

- 1 = Low
- 2 = Medium
- 3 = High

Dish	Accessories	Shelf position	Heating function	Temperature in °C	Steam intensity	Cooking time in mins.
Bread						
White bread, 750 g	Universal pan or cake tin	1		210-220*	-	10-15
				180-190	-	25-35
White bread, 750 g	Universal pan or cake tin	1		210-220	3	10-15
				180-190	-	25-35
Multigrain bread, 1.5 kg	Universal pan or cake tin	1		210-220*	-	10-15
				180-190	-	40-50
Multigrain bread, 1.5 kg	Universal pan or cake tin	1		210-220	3	10-15
				180-190	-	45-55
Wholemeal bread, 1 kg	Universal pan	1		210-220*	-	10-15
				180-190	-	40-50
Wholemeal bread, 1 kg	Universal pan	1		210-220	3	10-15
				180-190	-	40-50
Flatbread	Universal pan	1		220-240	-	25-35
Flatbread	Universal pan	2		220-230	3	20-30
Bread rolls						
Part-cooked rolls or baguette, pre-baked	Universal pan	2		200-220	-	10-20
Part-cooked rolls or baguette, pre-baked	Baking tray	2		200-220	2	10-20
Bread rolls, sweet, fresh	Baking tray	1		170-180*	-	15-25
Bread rolls, sweet, fresh	Baking tray	1		160-170	3	25-35
Bread rolls, sweet, fresh, 2 levels	Universal pan + baking tray	3+1		150-160*	-	20-30
Bread rolls, fresh	Baking tray	1		180-200	-	25-35
Bread rolls, fresh	Baking tray	1		200-220	2	20-30
* Preheat						

Dish	Accessories	Shelf position	Heating function	Temperature in °C	Steam intensity	Cooking time in mins.
Baguette, pre-baked, chilled	Universal pan	2		200-220	-	10-20
Baguette, pre-baked, chilled	Baking tray	2		200-220	2	10-20
Regenerate bread rolls, baguettes	Wire rack	1		150-160*	-	10-20
Bread rolls, frozen						
Part-cooked rolls or baguette, pre-baked	Universal pan	2		200-220	-	15-25
Part-cooked rolls or baguette, pre-baked	Baking tray	2		180-200	1	15-25
Lye bread, pieces of dough	Wire rack	1		220-240	-	15-25
Lye bread, pieces of dough	Baking tray	2		210-230	1	18-25
Croissant, pieces of dough	Baking tray	1		150-170*	-	20-35
Croissant, pieces of dough	Baking tray	1		180-200	1	20-30
Regenerate bread rolls, baguettes	Wire rack	1		160-170*	-	10-20
Toast						
Toast with topping, 4 slices	Wire rack	2		275	-	5-15
Toast with topping, 12 slices	Wire rack	2		250	-	5-15
Browning toast	Wire rack	3		275	-	3-6

* Preheat

Pizza, quiche and savoury cakes

Your appliance offers you a range of heating types for preparing pizza, quiche and savoury cakes. You can find the ideal settings for many dishes in the settings tables.

Also refer to the notes in the section on allowing dough to rise.

Only use original accessories supplied with your appliance. These have been tailored to the cooking compartment and the operating modes of your appliance.

Steam- assisted baking

Certain types of baked item (e.g. yeast-risen pastries) get a more crispy crust and a more glossy surface if baked with the steam assist mode. The baked item does not dry out as much.

Steam-assisted baking is only possible on one level.

Shelf positions

Use the indicated shelf positions.

Baking on one level

When baking on one level, use the following shelf position:

- Level 1

Baking on two levels

Use CircoTherm. Baked items that are placed into the oven on trays or in baking tins/dishes at the same time will not necessarily be ready at the same time.

- Universal pan: Level 3
Baking tray: Level 1
- Baking tins/dishes on the wire rack
First wire rack: Level 3
Second wire rack: Level 1

By preparing several dishes at the same time, you can make energy savings of up to 45 per cent. Position baking tins/dishes next to one another or offset and vertically stacked in the cooking compartment.

Accessories

Ensure that you always use suitable accessories and that they are placed in the oven the right way around.

Wire rack

Insert the wire rack with the open side facing the appliance door and the curved lip pointing downwards. Always place ovenware, tins and dishes on the wire rack.

Universal pan or baking tray

Slide the universal pan or the baking tray in carefully as far as the limit stop with the bevelled edge facing the appliance door.

Use the universal pan for pizzas with many toppings.

Baking tins

Dark- coloured metal baking tins are most suitable.

Tinplate baking tins, ceramic dishes and glass dishes extend baking time and mean that the baked item will not brown evenly.

The baking tins must be resistant to heat and steam for use in steam-assisted baking.

Greaseproof paper

Only use greaseproof paper that is suitable for the selected temperature. Always cut greaseproof paper to size.

Frozen products

Do not use frozen products that are heavily frosted. Remove any ice on the food.

Some frozen products may be unevenly pre-baked. Uneven browning may remain even after baking.

Recommended setting values

The table lists the optimal heating type for various types of food. The temperature and baking time depend on the amount and consistency of the dough/mixture. For this reason, the table specifies setting ranges. Try using the lower values to start with. A lower temperature will result in more even browning. You can use a higher setting next time if necessary.

Note: Baking times cannot be reduced by using higher temperatures. The food would only be cooked on the outside, but would not be fully baked in the middle.





The setting values apply to food that is placed into a cold cooking compartment; by doing this, you can make energy savings of up to 20 per cent. If you preheat the oven, you can reduce the indicated baking times by several minutes.

Preheating is necessary for selected food, and this is indicated in the table. Do not place your food or accessories into the cooking compartment until it has finished preheating.

If you wish to follow one of your own recipes when baking, you should use the setting values listed for similar baked items in the table as reference.



















Remove unused accessories from the cooking compartment. This will ensure that you achieve the best possible cooking results and energy savings of up to 20 per cent.





Types of heating used:

-  CircoTherm
-  Top/bottom heating
-  Circotherm intensive
-  Bread baking

The levels of steam intensity are indicated as numbers in the table:

- 1 = Low
- 2 = Medium
- 3 = High

Dish	Accessories	Shelf position	Type of heating	Temperature in °C	Steam intensity	Cooking time in mins.
Pizza						
Pizza, fresh	Baking tray	1		200-220	-	20-30
Pizza, fresh	Baking tray	1		220-230	-	25-30
Pizza, fresh, 2 levels	Universal pan + baking tray	3+1		180-200	-	35-45
Pizza, fresh, thin base	Pizza tray	1		210-230	-	20-30
Pizza, chilled	Wire rack	1		210-230	-	10-20
Pizza, frozen						
Pizza, thin base, x 1	Wire rack	1		210-230	-	10-20
Pizza, thin base, x 2	Wire rack + baking tray	3+1		200-220	-	15-25
Pizza, deep-pan, x 1	Wire rack	1		190-210	-	20-35
Pizza, deep-pan, x 2	Universal pan + wire rack	3+1		160-180	-	25-35
Pizza baguette	Wire rack	1		200-220	-	20-30
Mini pizza	Baking tray	1		210-230	-	10-20
Mini pizza	Wire rack	1		210-230	-	10-20
Savoury cakes and quiches						
Savoury cakes in a tin	Springform cake tin, diameter 28 cm	1		170-190	-	50-60
Savoury cakes in a tin	Springform cake tin, diameter 28 cm	1		180-190	1	65-75
Quiche	Flan-base cake tin, black	1		190-210	-	35-55
Quiche	Flan-base cake tin, black	1		190-210	-	30-45
Tarte flambée	Universal pan	1		260-280*	-	10-20
Tarte flambée	Universal pan	1		200-220*	2	15-25
Pierogi	Ovenproof dish	1		190-200	-	40-50
* Preheat						

Dish	Accessories	Shelf position	Type of heating	Temperature in °C	Steam intensity	Cooking time in mins.
Pierogi	Ovenproof dish	1		170-190	-	50-70
Empanada de atún	Universal pan	1		180-190	-	35-45
Empanada de atún	Universal pan	1		180-190	2	30-40
Börek	Universal pan	1		180-200	-	35-45
Börek	Universal pan	1		180-200	-	35-45
* Preheat						

Bakes and soufflés

Your appliance offers a range of heating types for preparing bakes and soufflés. You can find the ideal settings for many dishes in the settings tables.

Only use original accessories supplied with your appliance. These have been tailored to the cooking compartment and the operating modes of your appliance.

Shelf positions

Always use the indicated shelf positions.

You can prepare dishes on one level in tins/dishes or the universal pan.

- Baking tins/dishes on the wire rack: Level 1
- Universal pan: Level 1

Use the steam function for soufflés. You do not require a water bath. Place the small dishes into the perforated steam container, size XL, or onto the wire rack.

Food which would normally be prepared in a water bath should always be covered with foil.

By preparing several dishes at the same time, you can make energy savings of up to 45 per cent. Position baking tins/dishes next to one another in the cooking compartment.

Accessories

Ensure that you always use suitable accessories and that they are placed in the oven the right way around.

Wire rack

Insert the wire rack with the open side facing the appliance door and the curved lip pointing downwards. Always place ovenware, tins and dishes on the wire rack.

Universal pan

Slide in the universal pan carefully as far as the limit stop, with the bevelled edge facing the appliance door.

Cookware

Use wide, shallow cookware for bakes and gratins. In deep, narrow cookware, food requires more time to cook, and the top will be darker.

The baking tins/dishes must be resistant to heat and steam for use in steam-assisted cooking.

Recommended setting values

In the table, you can find the ideal heating type for various bakes and soufflés. The temperature and cooking time are dependent on the quantity of food and the recipe. How well cooked a bake is will depend on the size of the cookware and the depth of the bake. Settings ranges are indicated for this reason. Try using the lower values at first. A lower temperature results in more even browning. You can increase the temperature next time if necessary.





Note: Cooking times cannot be reduced by using higher temperatures. Bakes or soufflés would only be cooked on the outside, but would be raw in the middle.

The setting values apply to dishes placed into a cold cooking compartment. By doing so, you can make energy savings of up to 20 per cent. If you preheat the oven, the indicated cooking times will be reduced by several minutes.

If you wish to follow one of your own recipes when cooking, you can use similar dishes in the table as a reference.

Remove unused accessories from the cooking compartment. This will achieve the best possible cooking results and energy savings of up to 20 per cent.

Types of heating used:

-  CircoTherm
-  Top/bottom heating
-  Circo-roasting
-  Circotherm intensive
-  Steam cooking

The levels of steam intensity are indicated as numbers in the table:

- 1 = Low
- 2 = Medium
- 3 = High

Dish	Accessories/cookware	Shelf position	Type of heating	Temperature in °C	Steam intensity	Cooking time in mins.
Bake, savoury, cooked ingredients	Ovenproof dish	1		200-220	-	35-55
Bake, savoury, cooked ingredients	Ovenproof dish	1		160-170	2	40-50
* Preheat						

Dish	Accessories/cookware	Shelf position	Type of heating	Temperature in °C	Steam intensity	Cooking time in mins.
Bake, sweet	Ovenproof dish	1	≡	170-190	-	45-60
Bake, sweet	Ovenproof dish	1	⌘	160-180	-	40-50
Lasagne, fresh, 1 kg	Ovenproof dish	1	⌘	160-180	-	50-60
Lasagne, fresh, 1 kg	Ovenproof dish	1	⌘	170-180	2	35-45
Lasagne, frozen, 400 g	Universal pan	1	⌘	190-210	-	30-40
Lasagne, frozen, 400 g	Cookware, uncovered	1	⌘	180-190	2	40-50
Potato gratin, raw ingredients, 4 cm deep	Ovenproof dish	1	⌘	170-180	-	50-60
Potato gratin, raw ingredients, 4 cm deep	Ovenproof dish	1	⌘	170-190	2	60-70
Soufflé	Ovenproof dish	1	⌘	160-170*	-	40-50
Soufflé	Ovenproof dish	1	⌘	170-180	2	30-40
Soufflé	Individual moulds	1	⌘	100	-	40-45

* Preheat

Poultry

Your appliance offers you a range of heating types for preparing poultry. You can find the ideal settings for certain dishes in the settings tables.

Roasting on the wire rack

Roasting on the wire rack is particularly well suited for larger poultry or for multiple pieces at the same time.

Slide the universal pan into the oven at the indicated shelf position with the wire rack attached. Ensure that the wire rack is correctly positioned on the universal pan. → "Accessories" on page 12

Depending on the size and type of the poultry, pour up to ½ litres of water into the universal pan. Any dripping fat will be caught. You can make a sauce from these juices. This will also result in less smoke and ensure that the cooking compartment stays cleaner.

Roasting in cookware

Only use cookware which is suitable for use in an oven. Check whether the cookware fits in the cooking compartment.

Glass cookware is most suitable. Place hot glass cookware onto a dry mat after cooking. If the surface is damp or cold, the glass may crack.

Shiny roasting dishes made from stainless steel or aluminium reflect heat like a mirror and are therefore not particularly suitable. The poultry cooks slower and does not brown so well. Use a higher temperature and/or a longer cooking time.

Observe the manufacturer's instructions for your roasting cookware.

Uncovered cookware

It is best to use a deep roasting tin/dish for roasting poultry. Place the tin/dish onto the wire rack. If you do not have any suitable cookware, use the universal pan.

Covered cookware

When cooking with covered cookware, the cooking compartment remains considerably cleaner. Ensure that the lid fits well and closes properly. Place the cookware onto the wire rack.

Very hot steam may escape when opening the lid after cooking. Lift the lid at the rear, so that the hot steam can escape away from you.

Poultry can also become crispy in a covered roasting dish. To do so, use a roasting dish with a glass lid and set a higher temperature.

Steam-assisted roasting

Certain foodstuffs will become crispier during steam-assisted cooking. Their surface becomes glossier and they dry out less.

Use uncovered cookware. Cookware must be heat- and steam-resistant.

Use steam-assisted cooking if it is indicated in the settings table. Some dishes turn out best if they are cooked in several stages. These are indicated in the table.

Steaming

Poultry products are cooked more gently using the steaming function than with steam assistance. They remain particularly succulent. As an alternative, you can also fry poultry products quickly before steaming; the cooking time will be reduced.

Larger pieces require a longer heating-up time and a longer cooking time. If you are using several pieces which are the same weight, the heating-up time is increased, and not the cooking time.

Poultry items do not have to be turned.

Use the perforated steam container (size XL) and slide the universal pan in underneath. You can also use a glass tray and place this onto the wire rack.

Grilling

Keep the appliance door closed when using the grill. Never grill with the appliance door open.

Place the food to be grilled on the wire rack. In addition, slide the universal pan in at least one shelf position lower, with the slanted edge facing the appliance door. Any dripping fat will be caught.

When grilling, try wherever possible to use pieces of food which are of a similar thickness and weight. This will allow them to brown evenly and remain succulent and juicy. Place the food to be grilled directly onto the wire rack.

Use tongs to turn the pieces of food you are grilling. If you pierce the meat with a fork, the juices will run out and it will become dry.

Notes

- The grill element switches itself continuously on and off; this is normal. The set temperature determines how frequently this occurs.
- Smoke may be produced when grilling.

Meat thermometer

You can cook accurately using a meat thermometer. Read important notes on using the meat thermometer in the corresponding chapter. There, you can find notes on inserting the meat thermometer, the possible heating types and additional information. → "Meat thermometer" on page 27

Recommended setting values

In the table, you can find the ideal heating type for the kind of poultry you are cooking. The temperature and cooking time depend on the amount, composition and temperature of the food. Setting ranges are indicated for this reason. Try using the lower values at first. You can increase the temperature next time if necessary.

The setting values are based on the assumption that unstuffed, chilled, ready-to-roast poultry is placed into a cold cooking compartment. By doing so, you can make energy savings of up to 20 per cent. If you preheat the oven, the indicated cooking times will be reduced by several minutes.

In the table, you can find specifications for poultry with default values for the weight. If you wish to cook heavier poultry, use the lower temperature in every case. If cooking multiple pieces, use the weight of the heaviest piece as a reference for determining the cooking time. The individual pieces should be approximately equal in size.

A general rule: the larger the poultry is, the lower the cooking temperature and the longer the cooking time.

Turn the poultry after approx. 1/2 to 2/3 of the indicated time.





Note: Only use greaseproof paper that is suitable for the selected temperature. Always cut greaseproof paper to size.

Tips

- For duck or goose, pierce the skin on the underside of the wings. This allows the fat to run out.
- If using duck breast, score the skin. Do not turn duck breasts.
- When you turn poultry, ensure that the breast side or the skin side is underneath at first.
- Poultry will turn out particularly crispy and brown if you baste it towards the end of the roasting time with butter, salted water or orange juice.









Remove unused accessories from the cooking compartment. This will achieve the best possible cooking results and energy savings of up to 20 per cent.



















Types of heating used:

-  CircoTherm
-  Top/bottom heating
-  Circo-roasting
-  Circotherm intensive
-  Bread baking
-  Full-surface grill
-  Steam cooking

The levels of steam intensity are indicated as numbers in the table:

- 1 = Low
- 2 = Medium
- 3 = High

Dish	Accessories/cookware	Shelf position	Type of heating	Temperature in °C	Steam intensity	Cooking time in mins.
Chicken						
Chicken, 1 kg	Wire rack	1		200-220	-	60-70
Chicken, 1 kg	Wire rack	1		200-220	2	50-60
Chicken breast fillet, 150 g each (grilling)	Wire rack	2		275*	-	15-20
Chicken breast fillet (steaming)	Steam container	2+1		100	-	15-25
Small chicken portions, 250 g each	Wire rack	2		220-230	-	30-35
Small chicken portions, 250 g each	Wire rack	2		200-220	2	30-45
Chicken goujons, nuggets, frozen	Universal pan	2		200-220	-	10-20
Chicken goujons, nuggets, frozen	Universal pan	2		200-220	-	15-25
* Preheat for 5 mins						

Dish	Accessories/cookware	Shelf position	Type of heating	Temperature in °C	Steam intensity	Cooking time in mins.
Poulard, 1.5 kg	Wire rack	1		200-220	-	70-90
Poulard, 1.5 kg	Wire rack	1		180-200	2	65-75
Duck and goose						
Duck, 2 kg	Wire rack	1		180-200	-	90-110
Duck, 2 kg	Wire rack	1		150-160	2	70-90
				180-190	-	30-40
Duck breast, 300 g each	Wire rack	2		230-250	-	25-30
Duck breast, 300 g each	Wire rack	2		220-240	2	25-30
Goose, 3 kg	Wire rack	1		160-180	-	120-150
Goose, 3 kg	Wire rack	1		130-140	2	110-120
				150-160	2	20-30
				170-180	-	30-40
Goose legs, 350 g each	Wire rack	2		210-230	-	40-50
Goose legs, 350 g each	Wire rack	2		190-200	2	45-55
Turkey						
Small turkey, 2.5 kg	Wire rack	1		180-190	-	70-90
Small turkey, 2.5 kg	Wire rack	1		140-150	2	70-80
				170-180	-	20-30
Turkey breast, boned, 1 kg	Cookware, covered	1		240-250	-	80-110
Turkey thigh, with bone, 1 kg	Wire rack	1		180-200	-	80-100
Turkey thigh, with bone, 1 kg	Wire rack	1		170-180	2	80-100
* Preheat for 5 mins						

Meat

Your appliance offers you many heating types for preparing meat. You can find the ideal settings for many dishes in the settings tables.

Roasting and braising

Baste lean meat with fat as required or cover it with strips of bacon.

Score the rind crosswise. If you turn the joint when cooking, ensure that the rind is underneath at first.

When the joint is ready, turn off the oven and allow it to rest for another 10 minutes in the cooking compartment. This allows the meat juices to be better distributed. Wrap the joint in aluminium foil if necessary. The recommended standing time is not included in the cooking time specified.

Roasting on the wire rack

On the wire rack, meat will become very crispy on all sides.

Pour up to ½ litres of water into the universal pan, depending on the size and type of the meat. Dripping fat and meat juices will be caught. You can make a sauce using these juices. This will also result in less smoke and ensure that the cooking compartment stays cleaner.

Slide the universal pan into the oven at the indicated shelf position with the wire rack attached. Ensure that the wire rack is correctly positioned on the universal pan. → "Accessories" on page 12

Roasting and braising in cookware

It is more convenient to roast and braise meat in cookware. You can take the joint out of the cooking compartment more easily in the cookware, and prepare the sauce in the cookware itself.

Only use cookware which is suitable for use in an oven. Check whether the cookware fits in the cooking compartment.

Glass cookware is most suitable. Place hot glass cookware onto a dry mat after cooking. If the surface is damp or cold, the glass may crack.

Add in a little liquid for roasting if the meat is lean. A covering of approx. ½ cm depth should be applied to the base of any glass cookware.

The amount of liquid is dependent on the type of meat, the cookware material and also on whether or not a lid is used. If preparing meat in an enamelled or dark metal roasting dish, it will need a little more liquid than if cooked in glass cookware.

The steam evaporates in the cookware when roasting. Carefully pour in more liquid if required.

Shiny roasting dishes made from stainless steel or aluminium reflect heat like a mirror and are therefore not particularly suitable. The meat cooks more slowly and will not brown so much. Use a higher temperature and/or a longer cooking time.

Observe the manufacturer's instructions for your roasting cookware.

Uncovered cookware

Use a deep roasting tin/dish for roasting meat. Place the tin/dish onto the wire rack. If you do not have any suitable cookware, use the universal pan.

Covered cookware

When cooking with covered cookware, the cooking compartment remains considerably cleaner. Ensure that the lid fits well and closes properly. Place the cookware onto the wire rack.

The distance between the meat and the lid must be at least 3 cm. The meat may rise.

Very hot steam may escape when opening the lid after cooking. Lift the lid at the rear, so that the hot steam can escape away from you.

If necessary, braise the meat first by searing it. Add water, wine, vinegar or a similar liquid to the braising liquid. A covering approx. 1-2 cm deep should be applied to the base of the cookware.

The steam evaporates in the cookware when roasting. Carefully pour in more liquid if required.

Meat can also become crispy in a covered roasting dish. To do so, use a roasting dish with a glass lid and set a higher temperature.

Steam- assisted roasting and braising

Certain dishes become crispier if cooked using steam, and do not dry out as much.

Use uncovered cookware. Cookware must be heat- and steam-resistant.

The joints do not have to be turned.

Use steam-assisted cooking if it is indicated in the settings table. Some dishes turn out best if they are cooked in several stages. These are indicated in the table.

Steaming

By contrast to the steam assistance function, the steaming function cooks the meat particularly gently, but it does not become crispy on the outside. It remains very succulent. As an alternative, you can also fry pieces of meat quickly before steaming; the cooking time will be reduced.

Larger pieces require a longer heating-up time and a longer cooking time. If you are using several pieces which are the same weight, the heating-up time is increased, and not the cooking time.

Pieces of meat do not need to be turned.

Use the perforated steam container (size XL) and slide the universal pan in underneath. You can also use a glass tray and place this onto the wire rack.

Grilling

Keep the appliance door closed when using the grill. Never grill with the appliance door open.

Place the food to be grilled on the wire rack. In addition, slide the universal pan in at least one shelf position lower, with the slanted edge facing the appliance door. Any dripping fat will be caught.

When grilling, try wherever possible to use pieces of food which are of a similar thickness and weight. This will allow them to brown evenly and remain succulent and juicy. Place the food to be grilled directly onto the wire rack.

Use tongs to turn the pieces of food you are grilling. If you pierce the meat with a fork, the juices will run out and it will become dry.

Do not add salt until after the meat has been grilled. Salt draws water from the meat.

Notes

- The grill element switches itself continuously on and off; this is normal. The set temperature determines how frequently this occurs.
- Smoke may be produced when grilling.

Meat thermometer

You can cook accurately using a meat thermometer. Read important notes on using the meat thermometer in the corresponding chapter. There, you can find notes on inserting the meat thermometer, the possible heating types and additional information. → "*Meat thermometer*" on page 27

Recommended setting values

You can find the ideal heating type for many meat dishes in the table. Temperature and cooking time depend on the amount, composition and temperature of the food. Settings ranges are indicated for this reason. Try using the lower values at first. You can increase the temperature next time if necessary.

The setting values apply to chilled meat placed into the cold cooking compartment. By doing so, you can make energy savings of up to 20 per cent. If you preheat the oven, you can reduce the indicated cooking times by several minutes.

You can find information on roasts and default values for weights in the table. If you wish to roast a heavy joint of meat, you should definitely use a lower temperature. If roasting several joints, use the weight of the heaviest piece as a basis for determining the cooking time. The individual pieces should be approximately equal in size.





As a general rule: the larger a roasting joint is, the lower the cooking temperature and the longer the cooking time.

Turn roasting joints and grilled items after approx. $\frac{1}{2}$ to $\frac{2}{3}$ of the indicated time.

If you wish to follow one of your own recipes, you should use similar dishes as a reference. You can find additional information in the tips on roasting, braising and grilling attached to the settings table.

























Remove unused accessories from the cooking compartment. This will achieve the best possible cooking results and energy savings of up to 20 per cent.

Types of heating used:

-  CircoTherm
-  Top/bottom heating
-  Circo-roasting
-  Full-surface grill
-  Steam cooking

The levels of steam intensity are indicated as numbers in the table:

- 1 = Low
- 2 = Medium
- 3 = High

Dish	Accessories/cookware	Shelf position	Type of heating	Temperature in °C	Steam intensity	Cooking time in mins.
Pork						
Joint of pork without rind, e.g. neck, 1.5 kg	Wire rack	1		180-200	-	120-130
Joint of pork without rind, e.g. neck, 1.5 kg	Cookware, uncovered	1		180-190	1	110-130
Joint of pork with rind, e.g. shoulder, 2 kg	Wire rack	1		190-200	-	130-140
Joint of pork with rind, e.g. shoulder, 2 kg	Cookware, uncovered	1		100	-	25-30
				170-180	1	60-80
				200-210	-	25-30
Pork tenderloin steak, 1.5 kg	Cookware, uncovered	1		220-230	-	70-80
Pork tenderloin steak, 1.5 kg	Cookware, uncovered	1		170-180	1	80-90
Pork fillet, 400 g	Wire rack	2		220-230	-	20-25
Pork fillet, 400 g	Cookware, uncovered	1		210-220*	1	25-30
Pork fillet, 400 g	Steam container	2		100	-	18-20
Smoked pork on the bone, 1 kg (with a little added water)	Cookware, covered	1		210-220	-	60-80
Smoked pork on the bone, 1 kg	Cookware, uncovered	1		160-170	1	70-80
Pork steaks, 2 cm thick	Wire rack	3		250	-	16-20
Pork medallions, 3 cm thick (preheat oven for 5 mins.)	Wire rack	3		275*	-	8-12
Beef						
Fillet of beef, medium, 1 kg	Wire rack	1		210-220	-	40-50
Fillet of beef, medium, 1 kg	Cookware, uncovered	1		190-200	1	50-60
Pot-roasted beef, 1.5 kg	Cookware, covered	1		200-220	-	130-140
Pot-roasted beef, 1.5 kg**	Cookware, uncovered	1		150	3	30
				130	2	120-150
Sirloin, medium, 1.5 kg	Wire rack	1		220-230	-	60-70
Sirloin, medium, 1.5 kg	Cookware, uncovered	1		190-200	1	65-80
Viennese boiled beef, 1.5 kg	Cookware, uncovered	1		95	-	120-150
Steak, 3 cm thick, medium	Wire rack	2		275	-	15-20
Burger, 3-4 cm thick****	Wire rack	2		275	-	25-35















* Preheat

** At the start, pour approx. 100 ml of liquid into the cookware; the water tank must be topped up during operation

*** Slide the universal pan in underneath at shelf position 1

**** Turn after 2/3 of the total time

***** Do not turn

Dish	Accessories/cookware	Shelf position	Type of heating	Temperature in °C	Steam intensity	Cooking time in mins.
Veal						
Joint of veal, 1.5 kg	Cookware, uncovered	1		160-170	-	100-120
Joint of veal, 1.5 kg	Cookware, uncovered	1		170-180	1	90-110
Knuckle of veal, 1.5 kg	Cookware, uncovered	1		200-210	-	100-110
Knuckle of veal, 1.5 kg	Cookware, uncovered	1		170-180	1	100-120
Lamb						
Leg of lamb, boned, medium, 1.5 kg	Wire rack	1		170-190	-	50-70
Leg of lamb, boned, medium, 1.5 kg	Cookware, uncovered	1		170-180	1	80-90
Saddle of lamb on the bone*****	Wire rack	1		180-190	-	40-50
Saddle of lamb on the bone*****	Cookware, uncovered	1		200-210*	1	25-30
Lamb cutlet***	Wire rack	2		275	-	12-18
Sausages						
Grilled sausages	Wire rack	2		275	-	10-20
Wiener sausages	Steam container	2		80	-	14-18
Bavarian veal sausages	Steam container	2		80	-	12-20
Meat dishes						
Meat loaf, 1 kg	Cookware, uncovered	1		170-180	-	70-80
Meat loaf, 1 kg	Cookware, uncovered	1		190-200	1	70-80
* Preheat						
** At the start, pour approx. 100 ml of liquid into the cookware; the water tank must be topped up during operation						
*** Slide the universal pan in underneath at shelf position 1						
**** Turn after 2/3 of the total time						
***** Do not turn						

Tips on roasting and braising

The cooking compartment becomes very dirty.	Prepare your food in an enclosed roasting dish with higher temperature or use the grill tray. You will achieve the best roasting results if you use the grill tray. The grill tray can be bought later as a special accessory.
The roast is too dark and the crackling is burned in places, and/or the roast is too dry.	Check the shelf position and temperature. Select a lower temperature the next time and reduce the roasting time if necessary.
The crackling is too thin.	Increase the temperature or switch on the grill briefly at the end of the roasting time.
The roast looks good but the juices are burnt.	Next time, use a smaller roasting dish and add more liquid if necessary.
The roast looks good but the juices are too clear and watery.	Next time, use a larger roasting dish and add less liquid if necessary.
The meat gets burned during braising.	The roasting dish and lid must fit together well and close properly. Reduce the temperature and add more liquid when braising if necessary.

Fish

Your appliance offers you a range of heating types for preparing fish. You can find the ideal settings for many dishes in the settings tables.

The whole fish does not have to be turned. Place the whole fish into the cooking compartment in swimming position with the dorsal fin facing upwards. Placing half a potato or a small oven-proof container in the stomach cavity of the fish will provide stability.

You can tell when the fish is cooked because the dorsal fin can be removed easily.

Roasting and grilling on the wire rack

Place the food to be grilled on the wire rack. In addition, slide the universal pan in at least one shelf position lower, with the slanted edge facing the appliance door.

Pour up to ½ litres of water into the universal pan, depending on the size and type of the fish. Any dripping liquid will be caught. Less smoke is generated and the cooking compartment stays cleaner.

Keep the appliance door closed when using the grill. Never grill with the appliance door open.

When grilling, try wherever possible to use pieces of food which are of a similar thickness and weight. This will allow them to brown evenly and remain succulent and juicy. Place the food to be grilled directly onto the wire rack.

Use tongs to turn the pieces of food you are grilling. If you pierce the fish with a fork, the juices will run out and it will become dry.

Notes

- The grill element switches itself continuously on and off; this is normal. The set temperature determines how frequently this occurs.
- Smoke may be produced when grilling.

Roasting and stewing in cookware

Only use cookware which is suitable for use in an oven. Check whether the cookware fits in the cooking compartment.

Glass cookware is most suitable. Place hot glass cookware onto a dry mat after cooking. If the surface is damp or cold, the glass may crack.

Shiny roasting dishes made from stainless steel or aluminium reflect heat like a mirror and are therefore not particularly suitable. The fish cooks more slowly and browns less. Use a higher temperature and/or a longer cooking time.

Observe the manufacturer's instructions for your roasting cookware.

Uncovered cookware

To cook a whole fish, it is best to use a deep roasting tin/dish. Place the tin/dish onto the wire rack. If you do not have any suitable cookware, use the universal pan.

Covered cookware

When cooking with covered cookware, the cooking compartment remains considerably cleaner. Ensure that the lid fits well and closes properly. Place the cookware onto the wire rack.

When stewing, add two to three tablespoons of liquid and a little lemon juice or vinegar into the cookware.

Very hot steam may escape when opening the lid after cooking. Lift the lid at the rear, so that the hot steam can escape away from you.

Fish can also become crispy in a covered roasting dish. Here, use a roasting dish with a glass lid and set a higher temperature.

Steam- assisted roasting

Certain dishes become crispier if cooked using steam, and do not dry out as much.

Use uncovered cookware. Cookware must be heat- and steam-resistant.

The fish does not have to be turned.

Use steam-assisted cooking if it is indicated in the settings table. Some dishes turn out best if they are cooked in several stages. These are indicated in the table.

Steaming

The fish is cooked more gently using the steaming function, and remains particularly succulent.

Larger pieces require a longer heating-up time and a longer cooking time. If you are using several pieces which are the same weight, the heating-up time is increased, and not the cooking time.

Fish does not need to be turned.

Use the perforated steam container, size XL, and slide the universal pan in underneath. You can also use a glass tray and place this onto the wire rack.

Food which would normally be prepared in a water bath should always be covered with foil.

Meat thermometer

You can cook accurately using a meat thermometer. Read important notes on using the meat thermometer in the corresponding chapter. There, you can find notes on inserting the meat thermometer, the possible heating types and additional information. → *"Meat thermometer" on page 27*

Recommended setting values

You can find the ideal heating type for your fish dishes in the table. The temperature and cooking time depend on the amount, composition and temperature of the food. Settings ranges are indicated for this reason. Try using lower setting values first. You can use a higher setting next time if necessary.

The setting values are based on the assumption that chilled fish is placed into a cold cooking compartment. By doing so, you can make energy savings of up to 20 per cent. If you preheat the oven, you can reduce the indicated cooking times by several minutes.

In the table, you can find information for fish with default values for the weight. If you want to cook a heavier fish, you should definitely use the lower temperature. If cooking several fish, you should use the weight of the heaviest fish as a reference for determining the cooking time. The individual fish should be approximately the same size.





As a general rule: the larger a fish, the lower the cooking temperature and the longer the cooking time.

Turn any fish which is not in swimming position after approx. 1/2 to 2/3 of the indicated time.

Note: Only use greaseproof paper that is suitable for the selected temperature. Always cut greaseproof paper to size.

Remove unused accessories from the cooking compartment. This will achieve the best possible cooking results and energy savings of up to 20 per cent.

















Types of heating used:

-  Circo-roasting
-  Circotherm intensive
-  Bread baking
-  Full-surface grill
-  Steam cooking

en Tested for you in our cooking studio

The levels of steam intensity are indicated as numbers in the table:

- 1 = Low
- 2 = Medium
- 3 = High

Dish	Accessories/cookware	Shelf position	Type of heating	Temperature in °C	Steam intensity	Cooking time in mins.
Fish						
Fish, grilled, whole 300 g, e.g. trout	Wire rack	1		170-190	-	20-30
Fish, fried, whole 300 g, e.g. trout	Universal pan	1		170-180	2	15-20
				160-170	-	5-10
Fish, steamed, whole 300 g, e.g. trout	Steam container	2		80-90	-	15-25
Fish, grilled, whole 1.5 kg, e.g. salmon	Wire rack	1		170-190	-	30-40
Fish, steamed, whole 1.5 kg, e.g. cod	Steam container	2		80-90	-	35-50
Fish fillets						
Fish fillet, plain, grilled	Wire rack	2		220*	-	15-25
Fish fillet, plain, steamed	Steam container	2		80-100	-	10-16
Fish steaks						
Fish steak, 3 cm thick**	Wire rack	2		275	-	18-22
Fish, frozen						
Fish, whole 300 g, e.g. trout	Steam container	2		80-100	-	20-25
Fish fillet, plain	Cookware, covered	1		210-230	-	25-40
Fish fillet, plain	Cookware, covered	1		210-230	-	30-45
Fish fillet, au gratin	Wire rack	2		220-240	-	35-45
Fish fillet, au gratin	Cookware, uncovered	1		200-220	2	35-45
Fish fingers (turn during cooking)	Baking tray	1		220-240	-	10-20
Fish fingers (turn during cooking)	Baking tray	1		220-240	-	15-25
Fish dishes						
Fish terrine	Terrine mould	1		70-80	-	45-80
* Preheat						
** Slide the universal pan in underneath at shelf position 1						

Vegetables, side dishes and eggs

Here, you can find information on steaming fresh and frozen vegetables, potatoes, rice, cereals and eggs. You can also find information on cooking frozen chips, for example.

Steaming

Only use original accessories. When steaming in the perforated steam container (size XL), always slide the universal pan in underneath as well. Dripping liquid is caught.

Steaming on one level

Use the shelf positions indicated in the settings tables.

Steaming on two levels

Steaming on two levels is very well suited to simultaneously cooking broccoli and potatoes, for example. In cases where the cooking times are different, insert the foodstuff with the shorter cooking time later.

- Wire rack and attached steam container (size S), perforated and/or unperforated: Level 3
- Perforated steam container (size XL): Level 2

Cookware

If you use cookware, place it onto the wire rack or the perforated steam container, size XL.

Ovenware must be heat and steam resistant. Cooking times are increased when using cookware with thick edges.

Food which would normally be prepared in a water bath should always be covered with foil.

Cooking time and quantity

Cooking times when steaming are dependent on the size of the pieces, but not dependent on the total quantity. If a larger total quantity is used, the heating-up time is increased and not the cooking time.

Larger pieces require a longer heating-up time and a longer cooking time. If you are using several pieces which are the same weight, the heating-up time is increased, and not the cooking time.

Observe the unit sizes indicated in the settings table. The cooking time is reduced for smaller pieces and increased for larger ones. Cooking time is also influenced by the quality and ripeness of the food. This means that the setting values indicated are purely guidelines.

Always distribute the food evenly in the cookware. It will not cook evenly if the layers are of different depths. When layering delicate foods in the cooking container, do not pile them too high. It is better to use two containers.

Rice and cereals

Add water or liquid in the proportion indicated. E.g. "1:1.5" means adding 150 ml liquid per 100 g rice.

Baking and grilling

Only use original accessories.

Cooking on one level

Use the shelf positions indicated in the settings tables.

Cooking on two levels

Use CircoTherm. Food on baking trays that are placed in the oven at the same time will not necessarily be ready at the same time.

- Universal pan: Level 3
- Baking tray: Level 1

Accessories

Ensure that you always use suitable accessories and that they are placed in the oven the right way around.

Wire rack

Insert the wire rack with the open side facing the appliance door and the curved lip pointing downwards. Always place ovenware, tins and dishes on the wire rack.

Universal pan or baking tray

Slide the universal pan or the baking tray in carefully as far as the limit stop with the bevelled edge facing the appliance door.

Greaseproof paper

Only use greaseproof paper that is suitable for the selected temperature. Always cut greaseproof paper to size.

Recommended setting values







The table lists the optimal heating type for various types of food. The temperature and cooking time depend on the amount and composition of the food. For this reason, the table specifies setting ranges. Try using the lower values to start with. A lower temperature will result in more even browning. You can use a higher setting next time if necessary.

The setting values apply to food that is placed into a cold cooking compartment. If you preheat the oven, you can reduce the indicated cooking times by several minutes.

Preheating is necessary for selected food, and this is indicated in the table. Do not place your food or accessories into the cooking compartment until it has finished preheating.











If you wish to follow one of your own recipes when baking, you should use the setting values listed for similar food in the table as reference.



































Types of heating used:

-  CircoTherm
-  Top/bottom heating
-  Circotherm intensive
-  Bread baking
-  Full-surface grill
-  Steam cooking

The levels of steam intensity are indicated as numbers in the table:

- 1 = Low
- 2 = Medium
- 3 = High

Dish	Accessories/cookware	Shelf position	Type of heating	Temperature in °C	Steam intensity	Cooking time in mins.
Vegetables, fresh						
Steam artichokes, whole	Steam container	2		100	-	30-35
Steam cauliflower, whole	Steam container	2		100	-	25-35
Steam broccoli florets	Steam container	2		100	-	6-9
Steam green beans	Steam container	2		100	-	18-25
Steam sliced carrots	Steam container	2		100	-	10-20
Steam sliced kohlrabi	Steam container	2		100	-	20-25
Steam leeks in rings	Steam container	2		100	-	6-9
Steam corn on the cob	Steam container	2		100	-	30-40
Steam beetroot, whole	Steam container	2		100	-	43-50
Steam white asparagus, whole	Steam container	2		100	-	7-15

Dish	Accessories/cookware	Shelf position	Type of heating	Temperature in °C	Steam intensity	Cooking time in mins.
Steam spinach	Steam container	2		100	-	2-3
Steam courgettes, sliced	Steam container	2		100	-	3-4
Vegetables, frozen						
Spinach	Steam container	2		100	-	15-25
Cauliflower	Steam container	2		100	-	5-8
Green beans	Steam container	2		100	-	6-10
Broccoli	Steam container	2		100	-	6-7
Peas	Steam container	2		100	-	3-10
Carrots	Steam container	2		100	-	4-6
Brussels sprouts	Steam container	2		100	-	5-10
Mixed vegetables, 1 kg	Steam container	2		100	-	10-15
Vegetable dishes						
Grilled vegetables	Universal pan	3		275	-	10-15
Steam vegetable flan	Individual moulds	1		100	-	50-70
Potatoes						
Baked potatoes, halved	Universal pan	1		160-180	-	45-60
Baked potatoes, halved	Universal pan	2		180-190	1	40-50
Unpeeled boiled potatoes, whole	Steam container	2		100	-	35-45
Boiled potatoes, quartered	Steam container	2		100	-	20-25
Dumplings	Steam container	2		95	-	20-25
Potato products, frozen						
Potato rösti (turn during cooking)	Universal pan	2		200-220	-	20-30
Potato pockets, filled (turn during cooking)	Universal pan	2		190-210	-	15-25
Potato pockets, filled (turn during cooking)	Universal pan	2		200-220	-	18-28
Croquettes	Baking tray	1		200-220	-	15-25
Croquettes (turn during cooking)	Baking tray	1		210-230	-	15-25
Chips (turn during cooking)	Baking tray	1		190-210	-	20-30
Chips, 2 levels (turn during cooking)	Universal pan + baking tray	3+1		200-220	-	30-40
Rice						
Basmati rice, 1:1.5	Cookware, flat	1		100	-	20-30
Long-grain rice, 1:1.5	Cookware, flat	1		100	-	20-30
Brown rice, 1:1.5	Cookware, flat	1		100	-	35-45
Parboiled rice, 1:1.5	Cookware, flat	1		100	-	15-20
Risotto, 1:2	Cookware, flat	1		100	-	25-35
Cereals						
Couscous, 1:1	Cookware, flat	1		100	-	6-10
Millet, whole, 1:2.5	Cookware, flat	1		100	-	25-35
Polenta/corn semolina, 1:5	Cookware, flat	1		100	-	20-45
Pearl barley, 1:2.5	Cookware, flat	1		80-100	-	35-45
Lentils, 1:2	Cookware, flat	1		100	-	35-50

Dish	Accessories/cookware	Shelf position	Type of heating	Temperature in °C	Steam intensity	Cooking time in mins.
Cannellini beans, white, pre-softened; 1:2	Cookware, flat	1	☁	100	-	65-75
Semolina dumplings	Steam container	2	☁	95	-	6-10
Egg						
Egg custard with 2 eggs	Cookware, uncovered	1	☁	80	-	14-16
Eggs, hard-boiled	Steam container	2	☁	100	-	9-11
Eggs, soft-boiled	Steam container	2	☁	100	-	6-8

Dessert

You can prepare various desserts easily using your appliance.

Preparing yogurt

Remove accessories and shelves from the cooking compartment. The cooking compartment must be empty.

1. Heat 1 litre of milk (3.5 % fat) to 90 °C on the hob and then cool down to 40 °C.
It is sufficient to heat UHT milk to 40 °C.
2. Stir in 150 g (chilled) yogurt.
3. Pour into cups or small jars and cover with cling film.
4. Place the cups or jars onto the cooking compartment floor and use the settings indicated in the table.
5. After preparation, leave the yogurt to cool in the refrigerator.

Making rice pudding

1. Weigh the rice and add 2.5 times as much milk.
2. Fill a bowl with the rice and milk so that the mixture is max. 2.5 cm deep.
You can also use the universal pan for large quantities.
3. Use the settings indicated in the table.
4. Stir after cooking.
The remaining milk is quickly absorbed.

Compote

Weigh the fruit and add approx. 1/3 as much water. Add sugar and spices to taste. Use the settings indicated in the table.

Crème caramel and crème brûlée

Pour the mixture into the moulds to a thickness of 2-3 cm. Place the moulds directly into the perforated steam container (size XL). A bain marie is not required. Use the settings indicated in the table.

Food which would normally be prepared in a bain marie should always be covered with foil.

If the moulds are made from very thick material, this may extend the cooking time.

Dampfnudeln (steamed bread rolls)

Prepare the yeast dough according to your recipe without cooking. Place the shaped balls into a greased, perforated steam container (size XL), and allow them to prove. Use the settings indicated in the table.

Recommended setting values

Types of heating used:

- ☁ Steam cooking
- ☰ Dough proving

Dish	Accessories/cookware	Shelf position	Type of heating	Temperature in °C/ dough proving setting	Cooking time in mins.
Crème Brûlée	Individual moulds	1	☁	85	20-30
Crème caramel	Individual moulds	1	☁	85	25-35
Dampfnudeln	Universal pan	1	☁	100	25-30
Yoghurt	Individual moulds	Cooking compartment floor	☰	1	300-360
Rice pudding, 1:2.5	Universal pan	1	☁	100	35-45
Fruit compote	Universal pan	1	☁	100	10-20

Menu cooking

With your appliance you can cook a whole menu at once without the different flavours or aromas mixing with each other.

Place the food with the longest cooking time in the appliance first and add the rest at the appropriate time. This means that all the food will be ready at the same time.

Steaming

The overall cooking time is extended with menu cooking, as a little steam escapes each time the appliance door is opened and has to be reheated.

Observe the information in the relevant paragraphs of this section:

- The heating-up time varies depending on the size and weight of the food
- The cooking time does not depend on the quantity
- Use cookware that is steam-resistant
- Cover soufflé with foil
- Always insert the universal pan at level 1

Shelf positions for accessories

Always insert accessories in the following order:

- Level 3: Wire rack with steam container, size S
- Level 2: Steam container, size XL
- Level 1: Universal pan

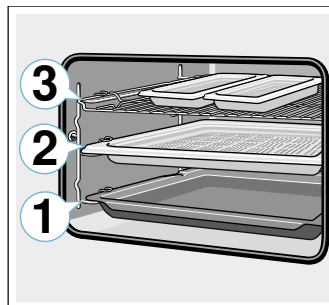

Recommended setting values

Type of heating used:

- ☁ Steam cooking

Dish	Accessories/cookware	Shelf position	Type of heating	Temperature in °C	Cooking time in mins.
Frozen salmon fillet	Unperforated steam container, size S	3	☁	100	20
Broccoli	Perforated steam container, size XL	2	☁	100	9
Boiled potatoes, quartered	Perforated steam container, size S	3	☁	100	25

Eco types of heating

CircoTherm eco and Top/bottom heating eco are intelligent heating types for the gentle preparation of meat, fish and pastries. The appliance optimally controls the supply of energy to the cooking compartment. The food is prepared in phases using residual heat. This means that it remains more succulent and browns less. Energy can be saved, depending on the preparation and food.

Place the food into the empty cooking compartment before it has heated up. Always keep the appliance door closed when cooking.

Remove unused accessories from the cooking compartment. This will allow you to achieve optimum cooking results and save energy.

Only use original accessories supplied with your appliance. These have been tailored to the cooking compartment and the operating modes of your appliance.

Accessories

Ensure that you always use suitable accessories and that they are placed in the oven the right way around.

Wire rack

Insert the wire rack with the open side facing the appliance door and the curved lip pointing downwards. Always place ovenware, tins and dishes on the wire rack.

Universal pan or baking tray

Slide the universal pan or the baking tray in carefully as far as the limit stop with the bevelled edge facing the appliance door.

Baking tins and cookware

Dark- coloured metal baking tins are most suitable. These allow you to make energy savings of up to 35 per cent.

Cookware made from stainless steel or aluminium reflects heat like a mirror. Non-reflective cookware made from enamel, heat-resistant glass or coated, die-cast aluminium is more suitable.

Tinplate baking tins, ceramic dishes or glass dishes prolong baking time, and the cake will not brown so evenly.

Greaseproof paper



Only use greaseproof paper that is suitable for the selected temperature. Always cut greaseproof paper to size.



























Recommended setting values

Here, you can find specifications for the various dishes with CircoTherm Eco and Top/bottom heating Eco. The temperature and baking time depend on the consistency and amount of the dough. Settings ranges are indicated for this reason. Try with the lower values first. A lower temperature results in more even browning. You can increase the temperature next time if necessary.

Note: Baking times can not be reduced by using higher temperatures. Cakes or baked items would only be cooked on the outside, but would not be fully cooked in the middle.

Types of heating used:

-  CircoTherm eco
-  Top/bottom heating Eco

Dish	Accessories/cookware	Shelf position	Type of heating	Temperature in °C	Cooking time in mins.
Cakes in tins					
Sponge cake in a tin	Ring tin/cake tin	1		140-160	60-80
Sponge flan base	Flan base tin	1		140-160	20-40
Sponge base, 2 eggs	Flan base tin	1		150-170	20-30
Sponge flan, 3 eggs	Springform cake tin, diameter 26 cm	1		160-170	25-35
Sponge flan, 6 eggs	Springform cake tin, diameter 28 cm	1		150-160	50-60
Bundt yeast cake	"Gugelhupf" ring cake tin	1		150-160	65-75
Cakes on baking trays					
Sponge cake with dry topping	Baking tray	1		160-180	20-40
Shortcrust tart with dry topping	Baking tray	1		170-180	25-35
Plaited loaf, savarin	Baking tray	1		150-160	35-45
Yeast cake with dry topping	Baking tray	1		150-170	20-35
Small baked items					
Muffins	Muffin tray	2		160-180	15-30
Small cakes	Baking tray	1		150-160	25-35
Puff pastry	Baking tray	2		170-190	25-50
Choux pastry	Baking tray	1		190-200	40-50
Biscuits	Baking tray	2		140-160	15-30
Piped cookies	Baking tray	2		140-150	25-40
Small yeast cakes	Baking tray	1		150-160	30-40
Bread & bread rolls					
Multigrain bread, 1.5 kg	Cake tin	1		200-210	35-45
Flatbread	Universal pan	1		240-250	20-25
Bread rolls, sweet, fresh	Baking tray	1		170-190	15-20
Bread rolls, fresh	Baking tray	1		180-200	25-35
Meat					
Joint of pork without rind, e.g. neck, 1.5 kg	Cookware, uncovered	1		180-190	120-140
Pot-roasted beef, 1.5 kg	Cookware, covered	1		200-220	140-160
Joint of veal, 1.5 kg	Cookware, uncovered	1		170-180	110-130
Fish					
Fish, braised, whole 300 g, e.g. trout	Cookware, covered	1		190-210	25-35
Fish, braised, whole 1.5 kg, e.g. salmon	Cookware, covered	1		190-210	45-55
Fish fillet, plain, braised	Cookware, covered	1		190-210	15-35

Acrylamide in foodstuffs

Acrylamide is mainly produced in grain and potato products prepared at high temperatures, such as potato

crisps, chips, sliced bread, bread rolls, bread or fine baked goods (biscuits, gingerbread, spiced biscuit).

Tips for keeping acrylamide to a minimum	
General	<ul style="list-style-type: none"> ■ Keep cooking times as short as possible. ■ Cook food until it is golden brown, but not too dark. ■ Large, thick pieces of food contain less acrylamide.
Baking	With top/bottom heating at max. 200 °C. With hot air at max. 180 °C.
Biscuits	With top/bottom heating at max. 190 °C. With hot air at max. 170 °C. Egg or egg yolk reduces the production of acrylamide.
Oven chips	Spread out a single layer evenly on the baking tray. Cook at least 400 g at once on a baking tray so that the chips do not dry out.

Slow cook

Slow cooking is a technique for cooking food over a long period at low temperatures. For this reason, it is also called "low-temperature cooking".

Slow cooking is ideal for all prime cuts (e.g. tender portions of beef, veal, pork, lamb or poultry) which are to be cooked "à point". The meat will remain succulent and tender.

The benefit of this cooking method is that it allows lots of scope for menu planning because slow-cooked meat is easy to keep warm. You do not have to turn the meat when cooking. Keep the appliance door closed in order to maintain an even cooking climate.

Only use fresh, clean and hygienic meat without bones. Carefully remove sinews and fat from around the edge. Fat develops a strong, distinct flavour during slow cooking. You can also use seasoned or marinated meat. Do not use defrosted meat.

Meat can be carved immediately following slow cooking. No standing time is required. Due to the special cooking method, the meat looks pink, but is not raw or undercooked.

Note: Delayed-start operation with an end time is not possible for the slow cooking heating type.

Cookware

Use flat cookware, e.g. a glass/porcelain serving dish. Place the cookware into the cooking compartment to preheat it.

Always place the uncovered cookware onto the wire rack at level 1.

You can find additional information in the tips on slow cooking attached to the settings table.

Your appliance features the heating type "Slow cook". Only start operation when the cooking compartment has fully cooled down. Allow the cooking compartment to warm up for around 10 minutes with the cookware inside.



Sear the meat on the hotplate at a very high heat and for a sufficiently long time on all sides, even on the ends. Place into the preheated cookware right away. Place the cookware containing the meat into the cooking compartment once again and cook slowly.













Recommended setting values

The slow cooking temperature and cooking time are dependent on the size, thickness and quality of the meat. Different settings ranges are indicated for this reason.

Type of heating used:

-  Low temperature cooking

Dish	Cookware	Shelf position	Heating function	Searing time in mins	Temperature in °C	Cooking time in mins
Poultry						
Duck breast, medium rare, 300 g each	Cookware, uncovered	1		6-8	95*	45-60
Chicken breast fillet, 200 g each, well done	Cookware, uncovered	1		4	120*	45-60
Turkey breast, boned, 1 kg, well done	Cookware, uncovered	1		6-8	120*	100-130
* Preheat						

Dish	Cookware	Shelf position	Heating function	Searing time in mins	Temperature in °C	Cooking time in mins
Pork						
Pork tenderloin steak, 5-6 cm thick, 1.5 kg	Cookware, uncovered	1		6-8	85*	130-180
Fillet of pork, whole	Cookware, uncovered	1		4-6	85*	45-70
Beef						
Joint of beef (rump), 6-7 cm thick, 1.5 kg	Cookware, uncovered	1		6-8	100*	150-190
Fillet of beef, 1 kg	Cookware, uncovered	1		4-6	85*	90-120
Sirloin, 5-6 cm thick	Cookware, uncovered	1		6-8	85*	120-180
Beef medallions/rump steak, 4 cm thick	Cookware, uncovered	1		4	85*	40-60
Veal						
Joint of veal, 4-5 cm thick, 1.5 kg	Cookware, uncovered	1		6-8	85*	100-130
Joint of veal, 7-10 cm thick, 1.5 kg	Cookware, uncovered	1		6-8	85*	150-210
Fillet of veal, whole, 800 g	Cookware, uncovered	1		4-6	85*	70-120
Veal medallions, 4 cm thick	Cookware, uncovered	1		4	80*	40-60
Lamb						
Saddle of lamb, boneless, 200 g each	Cookware, uncovered	1		4	85*	30-45
Leg of lamb, boned, medium, 1 kg, tied	Cookware, uncovered	1		6-8	95*	120-180
* Preheat						

Tips for slow cooking

Slow-cooking duck breast.	Place the cold duck breast into a pan and fry the skin side first. After slow cooking, grill for 3 to 5 minutes until crispy.
The slow-cooked meat is not as hot as conventionally roasted meat.	So that the roasted meat does not cool so quickly, warm the plates and serve the sauces very hot.

Drying

You can achieve outstanding drying results with CircoTherm. With this type of preserving, flavourings are concentrated by the dehydration.

Only use unblemished fruit, vegetables and herbs and wash them thoroughly. Line the wire rack with greaseproof paper or parchment paper. Drain the excess water from the fruit and dry it.

If necessary, cut it into equal chunks or thin slices. Place unpeeled fruit onto the dish with the sliced surfaces facing upwards. Ensure that neither fruit nor mushrooms overlap on the wire rack.

Grate vegetables and then blanch them. Allow the blanched vegetables to drain off and distribute them evenly on the wire rack.

Dry herbs on the stem. Position the herbs evenly and slightly heaped on the wire rack.

Use the following shelf positions when drying:

- 1 wire rack: Level 2
- 2 wire racks: Level 3+1

Turn very juicy fruit and vegetables several times. After drying, remove the dried products from the paper immediately.





Recommended setting values

In the table, you can find settings for drying various foodstuffs. The temperature and cooking time are dependent on the type, moisture, ripeness and thickness of the food to be dried. The longer you leave the food to be dried, the better it will be preserved. The thinner the slices are, the quicker the drying process will be and the more aromatic the dried food will remain. Setting ranges are indicated for this reason.

If you wish to dry additional foodstuffs, you should use similar foodstuffs in the table as a reference.

Type of heating used:

-  CircoTherm

Dish	Accessories	Shelf position	Type of heating	Temperature in °C	Cooking time in hours
Pomes (apple rings, 3 mm thick, 200 g per wire rack)	Wire rack	2		80	4-7
Stone fruit (plums)	Wire rack	2		80	8-10
Root vegetables (carrots), grated, blanched	Wire rack	2		80	4-7
Sliced mushrooms	Wire rack	2		60	6-8
Herbs, washed	1-2 wire racks	-		60	2-6

Preserving and juicing

Your appliance is also suitable for preserving and juicing.

Preserving

You can preserve fruit and vegetables using your appliance.

Warning – Risk of injury!

If the food is preserved incorrectly, the preserving jars may burst. Follow the instructions for preserving.

Jars

Use only clean and undamaged preserving jars. Only use heat-resistant, clean and undamaged rubber rings. Check clips and clamps in advance.

Tip: You can use the disinfecting function to clean the jars.

For each preserving process, only use preserving jars that are the same size and contain the same food. In the cooking compartment, you can preserve the contents of a maximum of six ½, 1 or 1½-litre preserving jars at the same time. Do not use jars that are larger or taller than this. The lids could rupture.

Preserving jars must not touch one another in the cooking compartment during the preserving process.

Preparing fruit and vegetables

Only use fruit and vegetables that are in good condition. Wash them thoroughly.

Peel, core and chop fruit and vegetables appropriate to their type and fill the preserving jars with them up to approx. 2 cm below the rim.

Fruit: Fill the preserving jars with the fruit along with a hot, skimmed sugar solution (approx. 400 ml for a 1-litre jar). For one litre of water:

- Approx. 250 g sugar for sweet fruit
- Approx. 500 g sugar for sour fruit

Vegetables: Fill the jars with the vegetables along with hot, boiled water.

Wipe the rims of the jars, as they must be clean. Place a damp rubber ring and a lid on each jar. Seal the jars with clamps. Place the jars into the perforated steam container (size XL) so that they do not touch each other. Pour 500 ml hot water (approx. 80 °C) into the universal pan. Use the settings indicated in the table.

Ending the preserving process

After the specified cooking time, open the appliance door. Do not remove the preserving jars from the cooking compartment until they have completely cooled down.

Wipe the cooking compartment clean afterwards.

Juicing

Before juicing, place the berries in a bowl and sprinkle with sugar. Leave to stand for at least one hour to draw out the juice.

Then fill the perforated steam container (size XL) with the berries and insert into the oven at level 2. Slide the universal pan in underneath to collect any juice. Use the settings indicated in the table.

After cooking, wrap the berries in a cloth and squeeze out the remaining juice.



Wipe the cooking compartment clean afterwards.



Recommended setting values

The times indicated in the settings table are guideline values for preserving fruit and vegetables and for juicing fruit. They may be influenced by room temperature, number of jars, quantity, heat and the quality of the jar contents. The specifications are based on 1-litre round jars.

Type of heating used:

-  Steam cooking

Dish	Accessories/cookware	Shelf position	Type of heating	Temperature in °C	Cooking time in mins.
Preserving					
Vegetables, e.g. carrots	1-litre preserving jars + XL steam container	1		100	30-120
Stone fruit, e.g. cherries, damsons	1-litre preserving jars + XL steam container	1		100	25-30
Pomes, e.g. apples, strawberries	1-litre preserving jars + XL steam container	1		100	25-30

Dish	Accessories/cookware	Shelf position	Type of heating	Temperature in °C	Cooking time in mins.
Juicing					
Raspberries	Steam container	2		100	30-45
Redcurrants	Steam container	2		100	40-50

Sterilising bottles and hygiene

Using your appliance, you can very easily sterilise cookware and baby feeding bottles. The process corresponds to normal sterilisation by boiling.

Sterilising bottles

Always clean the bottles with a bottle brush immediately after use. Then clean them in the dishwasher.

Place the bottles into the steam container, size XL, so that they do not touch each other. Start the programme "Sterilising". After sterilising, wipe the appliance down inside. Dry the bottles with a clean cloth after sterilising.

Hygiene

Your appliance is also suitable for preparing jam jars or preserving jars and their corresponding lids.

Post-treatment of jam is also possible. This improves the storage life of the jam.



Recommended setting values

Only use clean, intact jars and lids. They should ideally be cleaned in the dishwasher in advance. Cookware must be heat- and steam-resistant.

The recommended times are dependent on the jars used.

Type of heating used:

-  Steam cooking

Dish	Accessory	Shelf position	Type of heating	Temperature in °C	Cooking time in mins.
Hygiene					
Preparing jam jars or preserving jars	XL steam container	1		100	10-15
Post-treating jam jars	XL steam container	1		100	15-20
Sterilising clean cookware*	XL steam container	1		100	15-20

* This process corresponds to normal sterilisation by boiling.

Allowing the dough to prove at dough proving setting

Yeast dough will prove considerably more quickly using the "Dough proving" heating type than at room temperature and does not dry out. Only start operation when the cooking compartment has fully cooled down.

Always allow yeast dough to prove twice. Observe the specifications in the settings tables for the 1st and 2nd proving processes (dough fermentation and final fermentation).

Dough fermentation

Position the dough bowl on the wire rack for the dough fermentation. Use the settings indicated in the table.

Do not open the appliance door during the proving process, as moisture will escape. Do not cover the dough.

Final fermentation

Place your baked item into the oven at the shelf position indicated in the table.

Wipe moisture from the cooking compartment before baking.

Recommended setting values

The temperature and proving time are dependent on the type and quantity of the ingredients. The values in the table are therefore only meant to be average values.

Type of heating used:

-  Dough proving

Dish	Accessories/cookware	Shelf position	Type of heating	Step	Dough proving setting	Cooking time in mins.
Yeast dough, sweet						
E.g. small baked items	Bowl	1	☐	Dough fermentation	1	30-45
	Universal pan	1	☐	Final fermentation	1	10-20
Rich dough, e.g. panettone	Bowl	1	☐	Dough fermentation	2	40-90
	Tin on wire rack	1	☐	Final fermentation	2	30-60
Yeast dough, savoury						
E.g. pizza	Bowl	1	☐	Dough fermentation	1	20-30
	Universal pan	1	☐	Final fermentation	1	10-15
Bread dough						
White bread	Bowl	1	☐	Dough fermentation	1	30-40
	Universal pan	1	☐	Final fermentation	1	15-25
Multigrain bread	Bowl	1	☐	Dough fermentation	1	25-40
	Universal pan	1	☐	Final fermentation	1	10-20
Bread rolls	Bowl	1	☐	Dough fermentation	1	30-40
	Universal pan	1	☐	Final fermentation	1	15-25

Sous-vide

Sous-vide cooking is a method of cooking under a vacuum at low temperatures between 50-95 °C and in 100% steam.

Sous-vide cooking is a gentle method of preparing meat, fish, vegetables and desserts. A chamber vacuum-packing machine is used to heat-seal the food in a special air-tight, heat-resistant vacuum-sealing bag.

The protective envelope of the vacuum-sealing bag retains the nutrients and flavours. The low temperatures and the direct transfer of heat allow precisely controlled cooking in order to achieve the desired cooking results. It is almost impossible to overcook the food.

Portions

Take into consideration the specified quantities and sizes for the food listed in the settings table. For relatively large quantities and items, the cooking time must be adjusted accordingly. The appliance can cook up to 2 kg of food sous-vide.

The quantities given for fish, meat and poultry correspond to one to two portions. A portion size sufficient for four people has been selected for vegetables and desserts.

Rack levels

You can cook on up to two levels. For this purpose, always slide in the universal pan at level 1 to catch any drops of condensate. Insert the wire racks at the levels above accordingly.

Hygiene

Warning – Health risk!

Sous-vide cooking is a method of cooking at low temperatures. As a result, it is important that you always follow the application and hygiene instructions below:

- Only use high-quality, perfectly fresh food.
- Wash and disinfect your hands. Use disposable gloves or cooking/grill tongs.
- Take extra care when preparing hygienically critical food, such as poultry, eggs and fish.
- Always thoroughly rinse and/or peel fruit and vegetables.
- Always keep work surfaces and chopping boards clean. Use different chopping boards for different types of food.

- Maintain the cold chain. Make sure that you only interrupt it briefly to prepare the food, and then return the food in its vacuum-sealed bag to the refrigerator for storage before you cook it. Store the prepared food for a maximum of 24 hours.
- Food is suitable for immediate consumption only. Once the food is cooked, consume it immediately. Do not store it after cooking – not even in the refrigerator. It is not suitable for reheating.

Tip: Since germs can be found on the surface of almost all food, the best way to kill these germs is to put the vacuum-sealed, uncooked food in boiling water for a maximum of 3 seconds. This is the best way to prepare your ingredients for sous-vide cooking so that they are free from germs and hygienic. Then place the vacuum-sealing bag in the cooking compartment to sous-vide cook the food.

Vacuum-sealing bags

When using the sous-vide cooking method, only use heat-resistant vacuum-pack bags designed for this purpose.

The vacuum-sealing bag must only be used once. Do not use these bags more than once.

Do not cook the food in the bag you bought it in (e.g. portions of fish). These bags are not suitable for sous-vide cooking.

Vacuum-sealing

Use a chamber vacuum-packing machine that can create a 99% vacuum to vacuum-seal the food. This is the only way to achieve even heat transfer and therefore a perfect cooking result.

Note: To fill the vacuum-sealing bag, fold the edge of the bag down by 3-4 cm and place it into a container, e.g. into a measuring jug.

Before cooking the food, check whether the vacuum in the vacuum-sealing bag is intact. Make sure that:

- There is no/hardly any air in the vacuum-sealing bag.
- The heat-sealed seam is perfectly sealed.
- There are no holes in the vacuum-sealing bag. You do not use the core temperature probe.
- You do not pile pieces of meat or fish on top of one another.
- As far as possible, you avoid piling up vegetables and desserts when vacuum-sealing them.
- To ensure that the seam is perfect, it is important that the seam area on the edge of the vacuum-sealing bag does not become wet with food residue.

If in doubt, place the food into a new vacuum-sealing bag and vacuum-seal it again.

Food should be vacuum-sealed at most one day before it is cooked. This is the only way to prevent the escape of gases from the food (e.g. from vegetables) which inhibit the transfer of heat, or to prevent the texture of the food from changing, and thus altering how it cooks, as a result of the vacuum pressure.

Quality of the food

The quality of the cooking result is 100% influenced by the quality of the ingredients you use. Use only fresh, top-quality food. This is the only way to guarantee a consistent cooking result that delivers impeccable flavour.

Preparation

Cooking under a vacuum means that the flavours cannot escape. In using this method, please note that the usual quantities of seasoning and condiments, such as herbs, spices and garlic, can have a much greater effect on the flavour and can intensify the flavour. You should therefore start off by halving the quantities you usually use.

If the ingredients are of high quality, it is often sufficient to enclose them in the vacuum-sealing bag with just a small knob of butter and a little salt. Generally, the fact that the food's natural flavours intensify during cooking is sufficient on its own to produce a flavourful cooking result.

The following ingredients influence how the food is prepared:

- Salt and sugar reduce the cooking time
- Acidic food, such as lemon or vinegar, help the food to firm up.
- Alcohol or garlic give the food an unpleasant after-taste

Do not place the vacuum-sealed food items on top of one another or too close together on the wire racks. In order to ensure that the heat is distributed evenly, the food items should not be touching. Always slide in the universal pan at level 1 to catch any drops of condensate.

Caution!

Risk of damage to kitchen units

Only fill the water tank once for sous-vide cooking. Do not fill the water tank a second time. Otherwise, large volumes of water will accumulate on the cooking compartment floor. The water may leak out of the cooking compartment.

The preparation of food that is listed in the settings table is based on how long one tankful lasts.

In general, when the water tank has been completely filled, the following maximum cooking times apply, depending on the temperature:

Temperature in °C	Max. cooking time in min
50	270
60	210
70	150
80	120
90	90

Warning – Risk of scalding!

Hot water collects on the vacuum-sealing bag during cooking. Use an oven cloth to carefully lift the vacuum-sealing bag, so that the hot water runs off into the universal pan or the cooking container. Then use the oven cloth to carefully remove the vacuum-sealing bag.

Once the food is cooked, allow the cooking compartment to cool and then use a sponge to wipe away the water that is on the cooking compartment floor.

Dry the vacuum-sealing bag from the outside, place it in a clean container, and use scissors to open it. Place all of the food, along with its juices, into the container. You can use the stock or marinade to make a sauce.

The food can be finished off as follows once the sous-vide cooking stage is complete:

Meat: Flash fry in a frying pan at a very high temperature for a few seconds only on each side. This gives it a nice crust and the flavours you would expect from frying, without overcooking it.















Important: Dab the meat with a paper towel before placing it into hot oil, in order to avoid fat spitting out of the pan.













Vegetables: Flash fry in a frying pan to give them the flavours you would expect from frying. When frying vegetables like this, it is easy to season them or mix them with other ingredients.

Fish: Season and coat with hot butter.

Fry the food for longer if it has not been sufficiently well cooked during the sous-vide cooking stage.

Serve the food on pre-heated plates and, if possible, with a hot sauce or butter as sous-vide cooking takes place at relatively low temperatures.

Food	Accessories	Heating function	Temperature in °C	Cooking time in min	Tip/note
Meat					
Veal steak, medium, 2 cm thick	Wire rack + universal pan		60	80	Vacuum-seal along with some butter and rosemary.
Beef steak (topside, saddle, etc.), rare, 2 - 3 cm thick	Wire rack + universal pan		58	90	
Beef steak (topside, saddle, etc.), medium, 2 - 3 cm thick	Wire rack + universal pan		62	80	
Fillet steak, whole piece, rare, 3 - 4 cm thick	Wire rack + universal pan		58	100	
Fillet steak, whole piece, medium, 3 - 4 cm thick	Wire rack + universal pan		62	90	
Pork medallions (80 g each)	Wire rack + universal pan		63	75	Vacuum-seal along with some butter and fresh basil.
Saddle of lamb, boned	Wire rack + universal pan		58	50	Vacuum-seal along with some salt, butter and thyme.
Poultry					
Duck breast (350 g each)	Wire rack + universal pan		62	70	Cut into the layer of fat, season the meat side with a little salt and pepper, and vacuum-seal it along with a small piece of orange peel.
Chicken breast (250 g each)	Wire rack + universal pan		65	60	Vacuum-seal along with some butter, a little salt and some thyme.
Fish					
Cod (140 g each)	Wire rack + universal pan		58	25	Vacuum-seal along with some butter and a little salt.
Halibut/turbot (150 g each)	Wire rack + universal pan		58	30	
Pike-perch (140 g each)	Wire rack + universal pan		60	20	
Vegetables					
Cauliflower (500 g)	Wire rack + universal pan		85	40 - 50	Vacuum-seal along with a little water, butter, salt and nutmeg.
Mushrooms, quartered (500 g)	Wire rack + universal pan		85	20 - 25	Vacuum-seal along with some butter, rosemary, a little garlic and some salt.
Chicory, halved (x 4 - 6)	Wire rack + universal pan		85	40 - 45	Vacuum-seal along with some orange juice, sugar, salt, butter and thyme.

Food	Accessories	Heating function	Temperature in °C	Cooking time in min	Tip/note
Green asparagus, whole (600 g)	Wire rack + universal pan		85	20 - 30	Blanch before vacuum-sealing to retain the colour. Vacuum-seal along with some butter, salt, a little sugar and some pepper.
Carrots, in 0.5 cm slices (600 g)	Wire rack + universal pan		90	70 - 80	Vacuum-seal along with some orange juice, curry powder/paste and butter.
Potatoes, peeled and quartered (800 g)	Wire rack + universal pan		95	35 - 45	Vacuum-seal along with some butter and salt. Can easily be used for making dishes such as salad.
Cherry tomatoes, whole or halved (500 g)	Wire rack + universal pan		58	25 - 35	Mix together red and yellow cherry tomatoes. Vacuum-seal along with some olive oil, salt and sugar.
Squash, in 2 x 2 cm cubes (600 g)	Wire rack + universal pan		90	25 - 35	The cooking time may vary depending on the type of squash.
Courgettes, in 1 cm slices (600 g)	Wire rack + universal pan		85	25 - 30	Vacuum-seal along with some olive oil, salt and thyme.
Mangetout, whole (500 g)	Wire rack + universal pan		85	5 - 10	Vacuum-seal along with some butter and salt.
Dessert					
Pineapple in 1.5 cm slices (400 g)	Wire rack + universal pan		85	70 - 80	Vacuum-seal along with some butter, honey and vanilla.
Apple, peeled, in 0.5 cm slices (x 2 - 4)	Wire rack + universal pan		85	15 - 25	Vacuum-seal along with some caramel sauce. The cooking time may vary depending on the type of apple.
Bananas, whole (x 2 - 4)	Wire rack + universal pan		65	20 - 25	Vacuum-seal along with some butter, honey and a vanilla pod.
Pear, peeled, sliced (x 2 - 4)	Wire rack + universal pan		85	25 - 35	Add honey or sugar to sweeten.
Kumquats, halved (x 12 - 16)	Wire rack + universal pan		85	75 - 80	Rinse under warm water, cut in half and deseed. Vacuum-seal along with some butter, a vanilla pod, honey and apricot jam.
Vanilla sauce (0.5 l)	Wire rack + universal pan		80	15 - 25	Mix 0.5 l milk, 1 egg, 3 egg yolks, 80 g sugar, pulp of a vanilla pod, and vacuum-seal.

Defrosting

The defrost setting is suitable for defrosting frozen fruit and vegetables. Use the heating type 4D hot air to defrost baked items. Poultry, meat and fish should ideally be defrosted in the refrigerator.

Remove frozen food from any packaging when defrosting it.

Place frozen fruit and vegetables into the perforated steam container (size XL) and slide the universal pan in underneath. This means that the food does not remain in the meltwater and that any dripping liquid will be caught. Use the universal pan or cookware on the wire rack for frozen food where liquid should remain in the dish, e.g. frozen creamed spinach.



Place the baked item onto the wire rack.





Recommended setting values

The times in the table are average values. They are dependent on the quality, freezing temperature (-18 °C) and composition of the food. Time ranges are indicated. Set the shortest time first and then increase the time if necessary.

Tip: Items which were frozen flat or portioned defrost faster than those frozen in a block.

Types of heating used:

-  CircoTherm
-  Defrost setting

Dish	Accessories	Shelf position	Type of heating	Temperature in °C	Cooking time in mins.
Bread, bread rolls					
General	Baking tray	1		50	40-70
Cake					
Cake, moist	Baking tray	1		50	70-90
Cake, dry	Baking tray	1		60	60-75
Fruit, vegetables					
Berries	Steam container	2		30-40	10-15
Vegetables	Steam container	2		40-50	15-50

Reheating

Using heating type "Reheating", food is reheated gently using steam. It tastes and looks as though it has been freshly prepared. Even baked items from the day before can be re-crisped.

Use containers which are as flat, wide and heat-resistant as possible. Cold containers prolong the reheating process.

Where possible, only reheat dishes of the same size and type at the same time. If this is not possible, the time required for the component with the longest reheating time should be used as a basis.

Do not cover food while it is being reheated.

Place the food in the cookware onto the wire rack or place it directly onto the wire rack at level 1.

Do not open the appliance door during operation, as a lot of steam will escape.

Recommended setting values











In the table, you can find the ideal settings for various dishes. The times specified are only average values. They are dependent on the cookware used, the quality, temperature and consistency of the food. Time ranges are indicated. Set the shortest time first and then extend the time if necessary.

The values in the table apply to dishes placed into a cold cooking compartment. Preheating is necessary for selected dishes, and this is indicated in the table.

Remove unused accessories from the cooking compartment. This will allow you to achieve ideal cooking results and save energy.

Type of heating used:

-  Reheat

Dish	Accessories/cookware	Shelf position	Type of heating	Temperature in °C	Cooking time in mins.
Vegetables, chilled					
1 kg	Cookware, uncovered	1		120-130	15-25
250 g	Cookware, uncovered	1		120-130	5-15
Dishes, chilled					
Plated meal, 1 portion	Cookware, uncovered	1		120-130	15-25
Soup, stew, 400 ml	Cookware, uncovered	1		120-130	10-25
Side dishes, e.g. pasta, dumplings, potatoes, rice	Cookware, uncovered	1		120-130	8-25
Bakes, e.g. lasagne, potato gratin	Cookware, uncovered	1		120-140	10-25
Pizza, cooked	Wire rack	1		170-180*	5-15
Baked goods					
Bread rolls, baguette, baked	Wire rack	1		150-160*	10-20
Pastries (vol-au-vents)	Wire rack	1		180*	4-10
Baked goods, frozen					
Pizza, cooked	Wire rack	1		170-180*	5-15
Bread rolls, baguette, baked	Wire rack	1		160-170*	10-20

* Preheat

Keeping warm

You can keep cooked dishes warm using the "Keeping warm" heating type. You can use the various moisture levels to prevent the cooked dishes from drying out.

Do not cover the food.

Do not keep cooked dishes warm for longer than two hours. Be aware that some dishes may continue cooking whilst being kept warm. Do not cover the food.

The various steam levels are suitable for keeping the following foods warm:

- Level 1: Roasted joints and pan-fried foods
- Level 2: Bakes and side dishes
- Level 3: Stews and soups

Test dishes

These tables have been produced for test institutes to facilitate appliance testing.

As per EN 60350-1.

Baking

Baked items that are placed into the oven on trays or in baking tins/dishes at the same time will not necessarily be ready at the same time.

Shelf positions for baking on two levels:

- Universal pan: Level 3
Baking tray: Level 1

Apple pie



Apple pie on one level: place dark-coloured springform cake tins diagonally next to each other.

Cakes in tinplate springform cake tins: bake on one level with top/bottom heating. Place the springform cake tin onto the universal pan instead of onto the wire rack.

Notes





- The setting values apply to dishes placed into a cold cooking compartment.
- Please note the information in the tables about preheating. The setting values are valid without rapid heating-up.
- For baking, use the lower of the indicated temperatures first.

Types of heating used:

-  CircoTherm
-  Top/bottom heating
-  Circotherm intensive

The levels of steam intensity are indicated as numbers in the table:

- 1 = Low
- 2 = Medium
- 3 = High

Dish	Accessories/cookware	Shelf position	Type of heating	Temperature in °C	Steam intensity	Cooking time in mins.
Baking						
Shortbread	Baking tray	1		150-160*	-	25-40
Shortbread	Baking tray	1		140-150*	-	25-35
Shortbread, 2 levels	Universal pan + baking tray	3+1		140-150*	-	30-40
Small cakes	Baking tray	1		160*	-	25-35
Small cakes	Baking tray	1		150*	-	25-35
Small cakes, 2 levels	Universal pan + baking tray	3+1		150*	-	25-35
Fatless sponge cake	Springform cake tin, diameter 26 cm	1		160-170**	-	25-35
Fatless sponge cake	Springform cake tin, diameter 26 cm	1		160-170**	-	25-35
Fatless sponge cake	Springform cake tin, diameter 26 cm	1		150-160	1	10
					-	20-30
Apple pie	2 x black plate tins, diameter 20 cm	1		180-200	-	60-70
Apple pie	2 x black plate tins, diameter 20 cm	1		170-180	-	60-80

* Preheat for 5 mins, do not use quick heat function

** Preheat, do not use quick heat function

en Tested for you in our cooking studio

Steam

Slide the universal pan in under the perforated steam container (size XL) if indicated in the table. Any dripping liquid is caught.

Shelf positions for steaming on one level (use a maximum of 2.5 kg):



- Perforated steam container (size XL): Level 2

Shelf positions for steaming on two levels (use a maximum of 1.8 kg per level):

- Perforated steam container (size XL): Level 3
- Perforated steam container (size XL): Level 2

Type of heating used:

-  Steam cooking

Dish	Accessories	Shelf position	Type of heating	Temperature in °C	Cooking time in mins.
Steam					
Peas, frozen, two containers, 1.8 kg each	XL steam container x 2 + universal pan	3+2+1		100	3-15**
Broccoli, fresh, 300 g	XL steam container	2		100*	6-7***
Broccoli, fresh, one container	XL steam container	2		100*	6-7***
* Preheat					
** Test is over when 85°C is reached at the coldest spot (see IEC 60350-1)					
*** A comparable degree of cooking between reference sample and main sample is achieved if the reference sample is cooked for 5 minutes (produced as described in IEC 60350-1).					

Grilling

Also slide in the universal pan. The liquid will be caught and the cooking compartment stays cleaner.

Type of heating used:

-  Full-surface grill

Dish	Accessories	Shelf position	Type of heating	Temperature in °C	Cooking time in mins.
Grilling					
Browning toast	Wire rack	3		275	3-6
Beefburger, 12 pieces*	Wire rack	2		275	20-30
* Turn after 2/3 of the total time					



Constructa Neff
Vertriebs-GmbH
Carl-Wery-Straße 34
D-81739 München

Register your product online

www.neff-international.com



9001331673
970623
en