

SIEMENS



Washing machine

WM..N1... WM..N2...

siemens-home.bsh-group.com/welcome

en Instruction Manual and Installation Instructions

Register
your
product
online

Your new washing machine

You have chosen a Siemens washing machine.

Please take a few minutes to read and become familiar with the advantages of your washing machine.

To meet the high quality demands required by Siemens, every washing machine that leaves our factory is carefully checked to ensure that it functions correctly and is in perfect condition.

For more information on our products, accessories, replacement parts and services, see our website www.siemens-home.bsh-group.com or contact our after-sales service centres.

If the operating and installation instructions describe different models, any differences will be pointed out at the relevant points in the text.



Read these operating and installation instructions before switching on the washing machine.

Display rules

Warning!

This combination of symbol and signal word indicates a possibly dangerous situation. Not heeding the warning can cause death or injuries.

Caution!

This signal word indicates a possibly dangerous situation. Not heeding the caution can cause property and/or environmental damage.

Note/tip

Information about the optimum use of the appliance/any other useful information.

1. 2. 3. / a) b) c)

The steps are represented by numbers or letters.

■ / -

Lists are represented by a small box or a dash.

Contents

	Intended use	4
--	-------------------------------	---

	Safety instructions	5
--	--------------------------------------	---

Children/people/pets	5
Installation	6
Operation	7
Cleaning/Maintenance	8

	Environmental protection	9
--	---	---

Packaging/used appliance	9
Tips on economical use	9

	Positioning and connecting	10
--	---	----

Included with the appliance	10
Safety instructions	10
Installation surface	11
Installation on a base or a wooden joist floor	11
Installing the appliance in a kitchenette	11
Removing the transport bolts	11
Hose and cable lengths	12
Water inlet	12
Water outlet	13
Levelling	14
Electrical connection	14
Before washing for the first time	15
Transportation	15

	Getting to know the appliance	16
--	--	----

Washing machine	16
Control panel	17
Display panel	17



	Laundry	19
--	--------------------------	----

Preparing the laundry	19
Sorting laundry	19
Soaking	20

	Detergent	20
--	----------------------------	----

Correct selection of detergent	20
Saving energy and detergent	21

	Programme default settings	21
---	---	----

Temp. °C	21
rpm 	21
Finish in 	22

	Additional programme settings	23
---	--	----

speed/eco	23
Rinse+	23
Less Iron	23
Prewash	23

	Operating the appliance	24
---	--	----

Preparing the washing machine	24
Select programme/switch on the appliance	24
Change the programme default settings	24
Select additional programme settings	24
Placing laundry into the drum	25
Measure and add detergent and care products	25
Starting the programme	26
Childproof lock	26
Adding/removing laundry	27
Changing the programme	27
Cancelling the programme	27
Programme end during Rinse Stop	27
Programme end	27
Removing laundry/switching off the appliance	28

	Appliance settings	28
---	-------------------------------------	----

	Cleaning and maintenance	29
---	---	----

Machine housing/control panel	30
Drum	30
Descaling	30
Detergent drawer and housing	30
Cleaning the measuring aid A for liquid detergent	30
Detergent solution pump blocked	31
The drain hose at the siphon is blocked	31
Filter in the water supply is blocked	31



Faults and what to do about them 32

Emergency release 32

Information on the display panel . . . 33

Faults and what to do about them . . 34



After-sales service 35



Intended use

- This appliance is intended for private domestic use only.
- Do not install or operate this appliance anywhere that is liable to experience frost and/or outdoor conditions. There is a risk that the appliance will be damaged if residual water in it freezes. If hoses freeze up, they may crack/burst.
- This appliance must only be used for washing domestic laundry, consisting of machine-washable items and hand-washable woollens (see label on item). Using the appliance for any other purpose is outside of the scope of its intended application and is forbidden.
- This appliance is suitable for operation with mains water and commercially available detergents and care products (must be suitable for use in washing machines).
- This appliance is intended for use up to a maximum height of 4000 metres above sea level.

Before you switch on the appliance:

Check that there is no visible damage to the appliance. Do not operate the appliance if it is damaged. Should you have any problems, please contact your specialist dealer or our customer service.

Read and follow the operating and installation instructions and all other information provided with this appliance.

Retain the documents for subsequent use or for subsequent owners.

Safety instructions

The following safety information and warnings are provided to protect you from injury and to prevent material damage to your surroundings.

It is nevertheless important to take the necessary precautions and to proceed with care when installing, maintaining, cleaning and operating the appliance.

Children/people/pets

Warning **Risk of death!**

Children and other people who are unable to assess the risks involved when using the appliance may injure themselves or may find themselves in life-threatening situations. Therefore please note:

- The appliance may be used by children over the age of 8 years and by persons with reduced physical, sensory or mental capacity or by persons with a lack of experience or knowledge as long as they are supervised or have received instruction on how to use the appliance safely and they have understood the potential risks of using the appliance.
- Children must not play with this appliance.
- Do not allow children to clean or maintain this appliance unsupervised.
- Keep children under 3 years and pets away from this appliance.
- Do not leave the appliance unattended when children or other people who are unable to assess the risks are in the vicinity.

Warning **Risk of death!**

Children may lock themselves inside appliances and find themselves in a life-threatening situation.

- Do not position the appliance behind a door, as this may obstruct the appliance door or prevent it from opening completely.
- Once an appliance has reached the end of its life, pull the mains plug from the socket **before** severing the mains cable, and then destroy the lock on the appliance door.

Warning **Risk of suffocation!**

If allowed to play with the packaging/plastic film or packing components, children may become caught in these or pull them over their heads and suffocate.

Keep packaging, plastic film and packing components away from children.

Warning **Risk of poisoning!**

Detergents and care products may result in poisoning if consumed. If accidentally swallowed, seek medical advice. Keep detergents and care products out of the reach of children.

Warning **Risk of burns!**

When washing at high temperatures, the glass in the appliance door becomes hot.

Stop children from touching the appliance door when it is hot.

Warning **Eye/skin irritation!**

Contact with detergents or care products may cause eye/skin irritation. Rinse eyes/skin thoroughly if they/it come(s) into contact with detergents or care products. Keep detergents and care products out of the reach of children.

Installation



Warning

Risk of electric shock/fire/material damage/damage to the appliance!

If the appliance is not installed properly, this may lead to a dangerous situation. Ensure the following:

- The mains voltage on your power socket must match the rated voltage specified on the appliance (identification plate). The connected loads and the required fuse protection are specified on the identification plate.
- The appliance must only be connected to alternating voltage via a protective contact socket that has been correctly installed. This plug socket must be freely accessible at all times.
- The mains plug and the protective contact socket must match and the earthing system must be correctly installed.
- The installation must have an adequate cross section.
- The mains plug must be freely accessible at all times. If this is not possible, in order to comply with the relevant safety regulations, a switch (2-pole switch-off) must be built into the permanent installation in accordance with electrical installation regulations.
- If using a residual current circuit breaker, only use one that bears the following mark: . The presence of this mark is the only way to be sure that it fulfils all the applicable regulations.



Warning

Risk of electric shock/fire/material damage/damage to the appliance!

If the appliance's mains cable is altered or damaged, this may result in electric shock, short circuiting or fire due to overheating.

The mains cable must not be kinked, crushed or altered, and must not come into contact with any heat sources.



Warning

Risk of fire/material damage/damage to the appliance!

The use of extension cords or power strips may result in fire due to overheating or short circuiting. Connect the appliance directly to an earthed socket that has been correctly installed. Do not use extension cords, power strips or multi-way couplers.



Warning

Risk of injury/material damage/damage to the appliance!

- The appliance may vibrate or move when in operation, potentially resulting in injury or material damage.
Place the appliance on a clean, even, solid surface and, using a spirit level to guide you, level it with the screw-in feet.
- If you take hold of any of the appliance's protruding parts (e.g. the appliance door) in order to lift or move it, these parts may break off and cause injury.
Do not take hold of any of the appliance's protruding parts in order to move the appliance.



Warning

Risk of injury!

- The appliance is very heavy. Lifting it may result in injury.
Do not lift the appliance on your own.
- The appliance has sharp edges on which you could cut your hands. Do not take hold of the appliance by its sharp edges. Wear protective gloves to lift it.
- If the hoses and mains cables are not correctly routed, they may constitute a tripping hazard, which may result in injury.
Route hoses and cables such that they do not constitute a tripping hazard.

Caution!**Material damage/damage to the appliance**

- If the water pressure is too high or too low, the appliance may not be able to operate properly, and it may also result in material damage or damage to the appliance.
Make sure that the water pressure in the water supply facility is at least 100 kPa (1 bar), and does not exceed 1000 kPa (10 bar).
- If the water hoses are altered or damaged, this may result in material damage or damage to the appliance.
The water hoses must not be kinked, crushed, altered or severed.
- The use of hoses supplied by other brands to connect to the water supply may result in material damage or damage to the appliance.
Use the hoses supplied with the appliance or genuine spare part hoses only.
- The appliance is secured for transportation by transport locking devices. If the transport locking devices are not removed before the appliance is operated, this may result in damage to the appliance. It is important to completely remove all transport locking devices before using the appliance for the first time. Make sure that you retain these transport locking devices separately. It is important to refit the transport locking devices if the appliance is to be transported, in order to prevent the appliance from being damaged in transit.

Operation** Warning
Risk of explosions/fire!**

Laundry that has been pretreated with cleaning agents that contain solvents, e.g. stain remover/cleaning solvent, may cause an explosion in the drum. Rinse the laundry thoroughly with water before washing it in the machine.

** Warning
Risk of poisoning!**

Poisonous fumes may be given off by cleaning agents that contain solvents, e.g. cleaning solvent. Do not use cleaning agents that contain solvents.

** Warning
Risk of injury!**

- If you support your weight/sit on the appliance door when it is open, the appliance may tip over, which may result in injury.
Do not support your weight on the appliance door when it is open.
- If you climb onto the appliance, the worktop may break, which may result in injury.
Do not climb onto the appliance.
- If you reach into the drum while it is still rotating, you risk injuring your hands.
Wait until the drum has stopped rotating.

** Warning
Risk of scalding!**

When washing at high temperatures, there is a risk of scalding if you come into contact with hot detergent solution (e.g. when draining hot detergent solution into a washbasin). Do not reach into the hot detergent solution.

** Warning
Eye/skin irritation!**

Detergent and care products may spray out if the detergent drawer is opened while the appliance is in operation. Rinse eyes/skin thoroughly if they/it come(s) into contact with detergents or care products. If accidentally swallowed, seek medical advice.

Caution!

Material damage/damage to the appliance

- If the amount of laundry in the appliance exceeds its maximum load capacity, it may not be able to operate properly, or this may result in material damage or damage to the appliance.

Do not exceed the maximum load capacity of dry laundry. Make sure you comply with the maximum load capacities specified for each of the programs → Supplementary sheet for the operating and installation instructions.

- If you pour the wrong quantity of detergent or cleaning agent into the appliance, this may result in material damage or damage to the appliance.
Use detergents/care products/cleaning agents and softeners in accordance with the manufacturers' instructions.

Cleaning/Maintenance

Warning **Risk of death!**

The appliance is powered by electricity. There is a risk of electric shock if you come into contact with live components. Therefore please note:

- Switch off the appliance. Disconnect the appliance from the power supply (pull out the plug).
- Never take hold of the mains plug with wet hands.
- When removing the mains plug from the socket, always take hold of the plug itself and never the mains cable, otherwise this may damage the mains cable.
- Do not make any technical modifications to the appliance or its features.

- Repairs and any other work on the appliance must only be conducted by our customer service or by an electrician. The same applies for replacing the mains cable (when necessary).
- Spare mains cables can be ordered from our customer service.

Warning **Risk of poisoning!**

Poisonous fumes may be given off by cleaning agents that contain solvents, e.g. cleaning solvent. Do not use cleaning agents that contain solvents.

Warning **Risk of electric shock/material damage/damage to the appliance!**

If moisture penetrates the appliance, this may cause it to short circuit. Do not use a pressure washer, steam cleaner, hose or spray gun to clean your appliance.

Warning **Risk of injury/material damage/damage to the appliance!**

The use of spare parts and accessories supplied by other brands is dangerous and may result in injury, material damage or damage to the appliance. For safety reasons, use genuine spare parts and accessories only.

Caution! **Material damage/damage to the appliance**

Cleaning agents and agents for pretreating laundry (e.g. stain removers, prewash sprays, etc.) may cause damage if they come into contact with the surfaces of the appliance. Therefore please note:

- Do not allow these agents to come into contact with the surfaces of the appliance.
- Clean the appliance with nothing but water and a soft, damp cloth.
- Remove any detergent, spray or other residues immediately.



Environmental protection

Packaging/used appliance



Dispose of packaging in an environmentally-responsible manner.

This appliance is labelled in accordance with European Directive 2012/19/EU concerning used electrical and electronic appliances (Waste Electrical and Electronic Equipment - WEEE).

This directive specifies the framework for the return and recycling of used appliances as applicable throughout the EU.

- In order to save energy, the appliance switches to energy saving mode. The display panel lighting goes out after a few minutes and the  button flashes.
→ *"Display panel"* on page 17
- If the laundry is subsequently dried in a tumble dryer, select the spin speed according to the tumble dryer manufacturer's instructions.

Tips on economical use

- For optimum energy and water savings, fill the appliance with the maximum amount of laundry for each programme.
Overview of programmes
→ Supplementary sheet for the operating and installation instructions.
- Wash normally soiled laundry without a prewash.
- Save energy and detergent when washing lightly and normally soiled laundry.
→ *"Detergent"* on page 20
- The temperatures which can be selected refer to the care labels on the textiles. The temperatures used in the machine may deviate from this to ensure you get the optimum combination of energy-saving and washing results.



Positioning and connecting

Included with the appliance

Note: Check the machine for transport damage. Never use a damaged machine. If you have any complaints, contact the dealer from whom you purchased the appliance or our customer services.

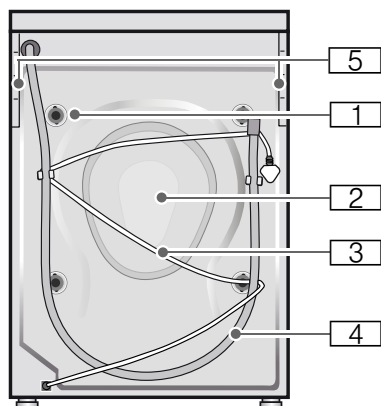

- 1 Transport bolts
- 2 Rear cover
- 3 Mains cable
- 4 Water drain hose
- 5 Support Struts, you can remove them by yourself as required.

The appliance also contains:

- Supplementary sheet for the operating and installation instructions
 - After-sales service location directory*
 - Warranty*
 - Cover caps for openings after the transport bolts have been removed
 - Bottom cover. Please install it correctly before using the appliance*
 - Water supply hose
 - Elbow for securing the water drain hose*
- * depending on the model

In addition, a hose clamp (24 - 40 mm diameter, available from specialist dealers) is required to connect the water drain hose to a siphon.

Useful tools

- Spirit level for aligning
- Spanner for loosening the transport bolts and for aligning the appliance feet

Safety instructions



Warning Risk of injury!

- The washing machine is very heavy. Be careful when lifting/transporting the washing machine; wear protective gloves.
- If the washing machine is lifted by its protruding parts (e.g. the washing machine door), the components may break off and cause injuries. Do not lift the washing machine by protruding parts.
- If the hose and mains cables are not routed properly, there is a risk of tripping and injury. Route hoses and cables in such a way that there is no risk of tripping.

Caution!

Damage to the appliance

Frozen hoses may rip/burst. Do not install the washing machine in areas exposed to frost or outdoors.

Caution!

Water damage

The connection points for the water supply hose and water drain hose are under high water pressure. To prevent leaks and water damage, you must follow the instructions in this section.

Notes

- In addition to the safety information listed here, the local water and electricity supplier may have special requirements.
- If in doubt, have the appliance connected by a specialist.

Installation surface

Note: The washing machine must be aligned in a stable manner so that it does not move around.

- The installation surface must be firm and level.
- Soft floors/floor coverings are not suitable.

Installation on a base or a wooden joist floor

Caution!

Damage to the appliance

The washing machine may "wander" and tip/topple from the base when spinning.

The feet of the appliance must be secured with holding brackets.

Note: On wooden joist floors, install the washing machine:

- In a corner, if possible,
- On a water-resistant wooden board (min. 30 mm thick) which is screwed tightly to the floor.

Installing the appliance in a kitchenette

Warning

Risk of death!

There is a risk of electric shock if you touch live components. Do not remove the appliance covering plate.

Notes

- Recess width of 60 cm required.
- Only install the washing machine underneath a continuous worktop that is securely connected to adjacent cabinets.

Removing the transport bolts

Caution!

Damage to the appliance

- The machine is secured for transportation using transport bolts. If the transport bolts are not removed, the machine may become damaged when it is operated. Before using the appliance for the first time, make sure that you completely remove all four transport bolts. Keep the bolts in a safe place.
- To prevent transport damage from occurring if the appliance is moved at a later date, you must refit the transport bolts before transporting the appliance.

Note: To avoid injury, take care when handling these.

1. Use a spanner to loosen all fixing bolts until they turn freely.
2. All four parts will fall to the floor when you tip the machine.

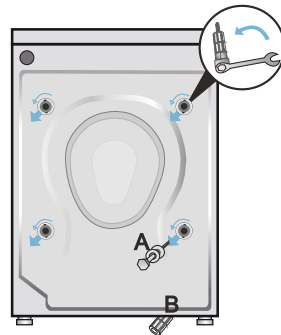

3. Insert the cover caps which you will find in the bag containing the documentation.



Hose and cable lengths

■ Left-hand connection

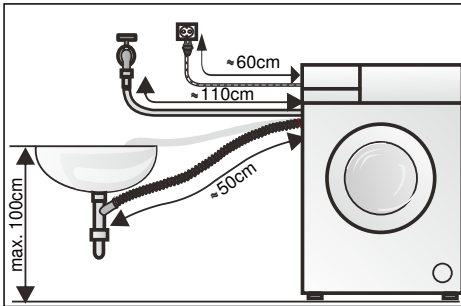

■ Right-hand connection

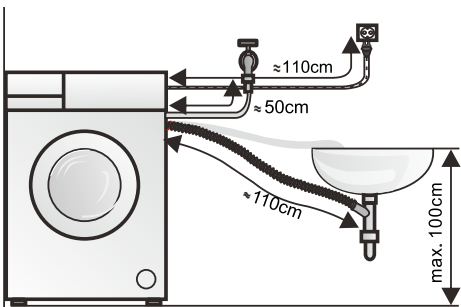

The following are available from specialist retailers/our after-sales service:

- Extension for cold water supply hose.
- A longer supply hose.

Water inlet

⚠ Warning **Risk of death!**

There is a risk of electric shock if you touch live components.

Notes

- To prevent leakage or water damage, follow the instructions in this section!
- Only operate the washing machine using cold mains water. Do not connect to the mixer tap of an unpressurised hot-water apparatus.
- Do not remove the water inlet hose frequently as the loose connection will lead to leaks. We recommend that you use a water inlet hose that is specially made for the machine.
- Do not use a used supply hose. Only use the supply hose supplied or one that was purchased from an authorised specialist retailer.
- Do not kink or squash the water supply hose.
- Do not alter (shorten, cut through) the water supply hose (otherwise its strength is no longer guaranteed).
- Only tighten the screw connections by hand. If the screw connections are tightened too much with a tool (pliers), the thread may become damaged.
- If in doubt, have the appliance connected by a technician.

Optimum water pressure in the supply network

At least 100 kPa (1 bar)

Maximum 1000 kPa (10 bar)

When the tap is open, the water flow is at least 8 l/min.

If the water pressure is higher than this, a pressure-reducing valve must be installed.

Connect the water supply hose to the water tap ($\frac{3}{4}$ " = 26.4 mm) and to the appliance:

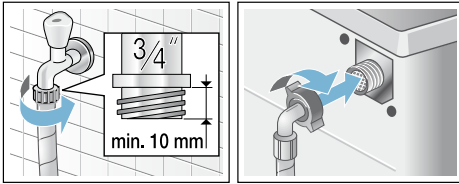

Note: Open the water tap carefully, checking the leak tightness of the connection points. The screw connection is under mains water pressure.

Water outlet

Caution! Water damage

If the drain hose slips out of the wash basin or the connection point during draining due to high water pressure, any escaping water may cause water damage.

Secure the drain hose so that it cannot slip out.

Note: Do not kink the water drain hose or put strain on it lengthways.

You can lay the water drain hose as follows:

■ Outlet in a sink

Warning **Risk of scalding!**

When you are washing at high temperatures, there is a risk of scalding if you come into contact with hot water e.g. if hot water is being drained into a wash basin. Do not reach into the hot water.

Caution!

Damage to the appliance/fabrics

If the end of the drain hose is immersed in the drained water, water may be sucked back into the appliance and may damage the appliance/fabrics.

Make sure that:

- The plug does not block drainage from the sink.
- The end of the drain hose is not immersed in the drained water.
- The water drains away quickly enough.

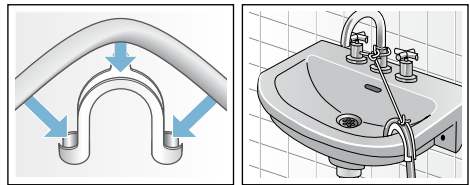

■ Drainage into a siphon

The connection point must be secured using a hose clamp with a diameter of 24-40 mm (available from specialist dealers).

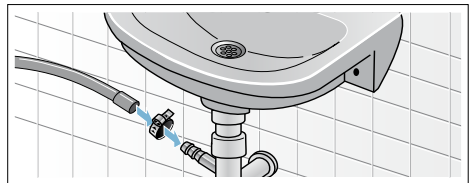

■ Outlet into a plastic pipe with rubber bushing or into a drainage pit

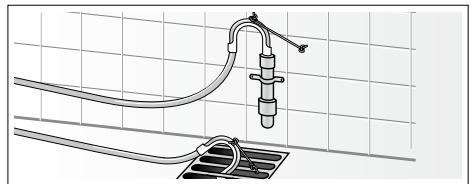

Levelling

Level the appliance using a spirit level. Incorrect levelling may result in intense noise, vibrations and "wandering".

1. Loosen the lock nuts using a wrench, by turning it in a clockwise direction.
2. Check the alignment of the washing machine with a spirit level, and adjust it if necessary. Change the height by turning the appliance feet. All four appliance feet must stand firmly on the ground.
3. Tighten the lock nut against the housing.
In doing so, hold the foot tight and do not adjust its height. The lock nuts on all four appliance feet must be screwed tightly against the housing.

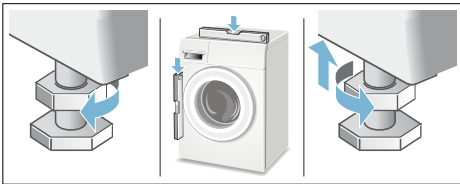

Electrical connection

Warning **Risk of death!**

There is a risk of electric shock if you touch live components.

- Never touch or hold the mains plug with wet hands.
- Only pull out the mains cable by the plug and never by the cable, as this could damage it.
- Never unplug the mains plug during operation.

Observe the following information and ensure that:

Notes

- The mains voltage and voltage indicated on the washing machine (rating plate) are the same. The connected load and fuse required are specified on the rating plate.
- The washing machine is only connected to an alternating current supply via a properly installed earthed socket.
- The mains plug fits the socket.
- The cable cross-section is adequate.
- The earthing system is properly installed.
- The mains cable is only replaced by a qualified electrician (if this is necessary). Replacement mains cables are available from the after-sales service.
- No multiple plugs/couplings or extension cables are used.
- If an earth-leakage circuit breaker is used, only a type which displays the  symbol is used. Only this symbol guarantees compliance with the currently applicable regulations.
- The mains plug can be accessed at all times.
- The mains cable is not kinked, squashed, altered or cut through.
- The mains cable does not come into contact with heat sources.

Before washing for the first time

The washing machine was thoroughly tested before leaving the factory. To remove any residues from the product and to remove water that may be left over from the test, run the first wash cycle **without** any laundry.

Note: The washing machine **must be correctly installed and connected.**

→ Page 10

1. Check the appliance.
Note: Never use a damaged machine. Inform the after-sales service.
2. Connect the mains plug.
3. Turn on the water tap.
4. Do not load any laundry. Close the door.
5. Depending on the model, run the **Drum Clean*** or **Cottons 90 °C** programme.
6. Open the detergent drawer.
7. Pour approximately 1 litre of water into compartment **II**.
8. Pour standard detergent into compartment **II**.
Note: To prevent foaming, only use half the amount of detergent recommended by the detergent manufacturer. Do not use detergents designed for wool or delicates.
9. Close the detergent drawer.
10. Press the  button.
11. When the programme ends, switch off the appliance.

Your washing machine is now ready to use.

* depending on the model

Transportation

e.g. when moving home

Preparatory work:

1. Turn off the water tap.
2. Reduce the water pressure in the supply hose.
→ *"Filter in the water supply is blocked" on page 31*
3. Drain the remaining detergent solution.
→ *"Detergent solution pump blocked" on page 31*
4. Disconnect the washing machine from the mains.
5. Remove the hoses.

Installing the transport bolts:

Remove four covers and the rear cover. Insert and tighten the transport bolts.

Before switching on the appliance again:

Notes

- The transport bolts **must** be removed. → Page 11
- To prevent unused detergent from flowing straight into the drain during the next wash: Pour approx. 1 litre of water into compartment **II** and start the **Spin/Empty** program.

Getting to know the appliance

Washing machine

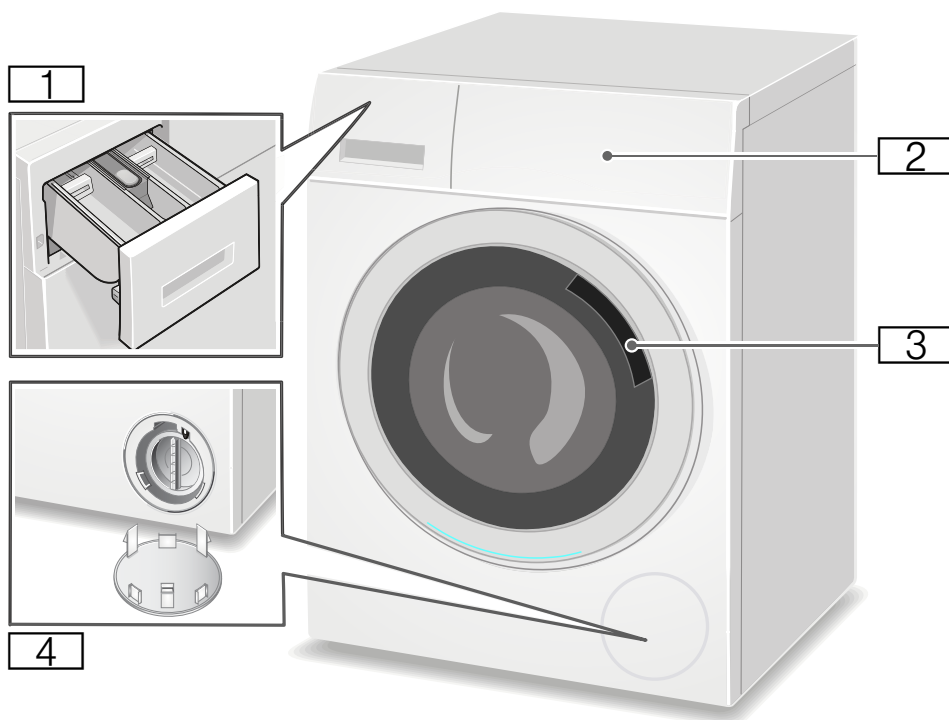

- 1** Detergent drawer
- 2** Operating/display panel
- 3** Loading door with door handle
- 4** Service flap

Control panel

Control panel differs depending on the model

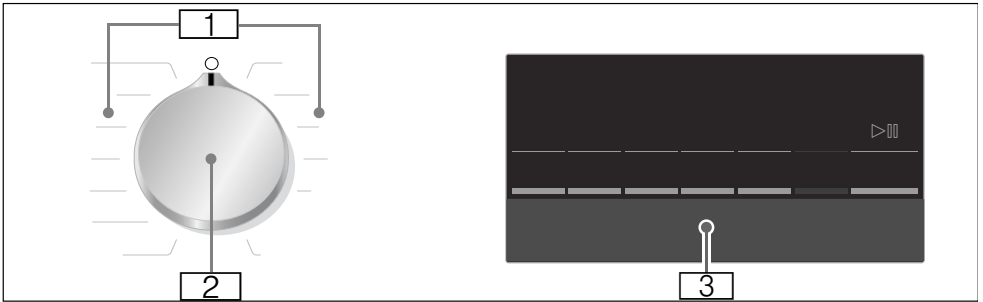

1 Programmes → Supplementary sheet for the operating and installation instructions.

2 Programme selector
3 Display panel for settings and information

Display panel

Note: The tables show possible setting options and information in the display panel; these differ depending on the model.

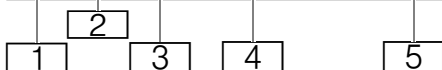
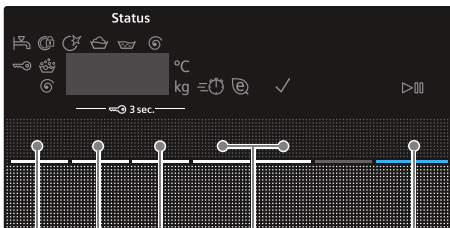
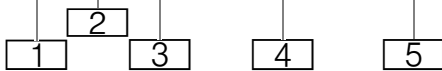
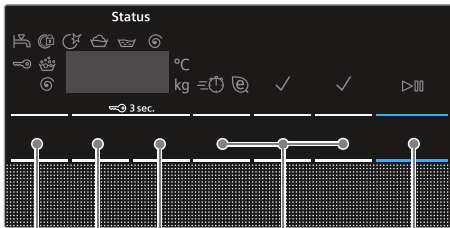

Button	Display indicator	Description
1	Selectable Temp. °C --- 90 °C**	in °C; --- = cold
2	Selectable rpm ⚙️ --- 0 - 1200 ** ⚙️	in rpm; 0 = no spin cycle, draining only; --- = Rinse Stop
3	Finish in 🕒 e.g. 2:30	Program duration depends on the program selection in h:min (hours:minutes)
4	1-24 h	End of programme ("Ready in" time) after ...h (hours)
4	Additional program settings: → Page 23	

* depending on the model

** depending on the selected program, settings and model

Button	Display indicator	Description
		speed/eco
		Less Iron*
		Rinse+*
		Prewash*
		Button for starting a program, Interrupting a program, e.g. to add items of laundry and cancelling a program
* depending on the model ** depending on the selected program, settings and model		

More information on the display panel

Display indicator	Description
	Load recommendation
	Program progress:
	Washing
	Rinsing
	Spinning
	Programme end
- - -	Programme end during Rinse Stop
	Washing machine door → "Adding/removing laundry" on page 27 → "Information on the display panel" on page 33
	Tap → "Information on the display panel" on page 33
* depending on the model ** depending on the selected program, settings and model	

Display indicator	Description
	Childproof lock → "Childproof lock" on page 26 → "Information on the display panel" on page 33
	Foam detection* → "Information on the display panel" on page 33
	Indicator lamp for Drum Clean programme* → "Information on the display panel" on page 33 → "Appliance settings" on page 28
	Fault display → "Information on the display panel" on page 33
	Signal setting → "Appliance settings" on page 28
* depending on the model ** depending on the selected program, settings and model	

Note: Energy saving mode

In order to save energy, the appliance switches to energy saving mode. The display lighting goes out after a few minutes and the button flashes. To activate the lighting, press any button. The energy saving mode is not activated if a programme is running.



Laundry

Preparing the laundry

Caution!

Damage to the appliance/fabrics

Foreign objects (e.g. coins, paper clips, needles, nails) may damage the laundry or components in the washing machine.

Therefore, note the following tips when preparing your laundry:

- Empty any pockets.

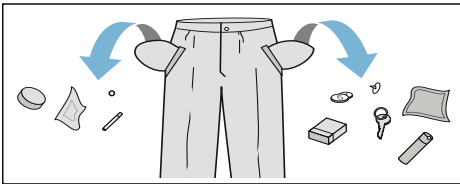

- Check for metal items (paper clips, etc.) and remove them.
- Wash delicates in a laundry bag (tights, underwired bras, etc.).

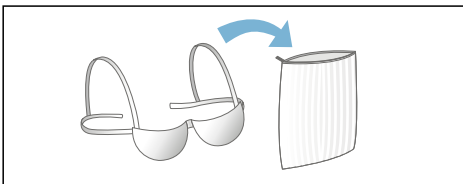

- Remove curtain fittings or place curtains in a laundry bag.
- Close any zips, button up any cover buttons.
- Brush sand out of pockets and collars.

Sorting laundry

Sort your laundry according to the care instructions and manufacturer's information on the care labels, depending on:

- Type of fabric/fibre
- Colour

Note: Laundry can discolour or not be cleaned correctly. Wash white and coloured items separately. Wash new coloured items separately the first time you wash them.

- Soiling
Wash laundry with the same level of soiling together.
Some examples of soiling levels:
→ *"Saving energy and detergent"* on page 21
 - **Light:** Do not prewash; select the **speed** setting if necessary
 - **Normal**
 - **Heavy:** Load less laundry; select a programme with prewash
 - **Stains:** Remove/pretreat stains while they are fresh. Firstly, dab with soapy water; do not rub. Then wash the items of laundry with the appropriate programme. Stubborn or dried-in stains can sometimes only be removed by washing several times.
- Symbols on the care labels
Note: The numbers in the symbols indicate the maximum washing temperature that may be used.



Suitable for normal washing process;
e.g. Cottons programme



A gentle washing process is required;
e.g. Easy-Care programme



An especially gentle washing process is required; e.g. Delicate/Silk programme



Suitable for washing by hand;
e.g. Wool programme



Do not machine wash.

Soaking

1. Pour soaking agent/detergent into compartment **II** in accordance with the manufacturer's instructions.
2. Select the desired programme.
3. Press the ▷ button to start the programme.
4. After approx. ten minutes, press the ▷ button to pause the programme.
5. After the desired soaking time, press the ▷ button again to continue or change the programme.

Notes

- Load laundry of the same colour.
- No additional detergent is required; the soaking solution is used for washing.



Detergent

Correct selection of detergent

The care label is crucial to ensure correct detergent selection, temperature and laundry treatment.

- **Standard detergent with optical brighteners**
suitable for heat-resistant white washing made from linen or cotton
Programme: Cottons / cold – max. 90 °C
- **Detergent for colours without bleach or optical brighteners**
suitable for coloured washing made from linen or cotton
Programme: Cottons / cold – max. 60 °C
- **Detergent for colours/delicates without optical brighteners**
suitable for coloured laundry made from easy-care fibres, synthetic fibres
Programme: Easy-Care / cold – max. 60 °C
- **Detergent for delicates**
suitable for delicate, fine fabrics, silk or viscose
Programme: Delicates/Silk / cold – max. 40 °C
- **Detergent for woollens**
suitable for woollen fabrics
Programme: Wool / cold – max. 40 °C

Saving energy and detergent

For light and normal soiling, you can save energy (lower washing temperature) and detergent.

Saving	Soiling/note
 <p data-bbox="68 312 244 448">Reduced temperature and detergent quantity as per the recommended dosage</p> <p data-bbox="68 954 244 1149">Temperature as per the care label and detergent quantity as per the recommended dosage for heavy soiling</p>	<p data-bbox="247 312 532 339">Light</p> <p data-bbox="247 344 532 419">No visible dirt or stains. Clothing has taken on some body odour, e.g.:</p> <ul data-bbox="247 424 532 616" style="list-style-type: none"> <li data-bbox="247 424 532 499">■ Light summer/sports clothing (worn for a few hours) <li data-bbox="247 504 532 555">■ T-shirts, shirts, blouses (worn for up to one day) <li data-bbox="247 560 532 616">■ Guest bed linen and hand towels (used for one day)
	<p data-bbox="247 620 532 647">Normal</p> <p data-bbox="247 652 532 699">Visible dirt or a few light stains, e.g.:</p> <ul data-bbox="247 703 532 831" style="list-style-type: none"> <li data-bbox="247 703 532 778">■ T-shirts, shirts, blouses (sweat soaked, worn a few times) <li data-bbox="247 783 532 831">■ Towels, bedding (used for up to one week)
	<p data-bbox="247 952 532 979">Heavy</p> <p data-bbox="247 984 532 1070">Dirt and/or stains clearly visible, e.g. tea towels, baby items, work clothing</p>

Note: When measuring the amount of all detergents/additives/care products and cleaning agents, please always check the manufacturer's instructions and information.
 → "Measure and add detergent and care products" on page 25

P+ Programme default settings

The programme default settings for all programmes are preset at the factory and are displayed in the display panel after the programme is selected.

You can change the default settings by repeatedly pressing the corresponding buttons until the required settings are displayed in the display panel.

Note: Pressing and holding the button automatically runs through the setting values until the last one. Press the button once more and you will be able to change the setting values again.

The available settings vary depending on the model.

You can find an overview of all settings available for selection in each programme on the supplementary sheet for the operating and installation instructions.

Temp. °C

Depending on what stage the programme is in, you can change the set temperature before and at the beginning of the programme.

Notes

- The maximum temperature that can be set depends on the programme that has been selected.
- The remaining time may be increased or decreased according to the changed temperature values.

rpm ⌚

Depending on what stage the programme is in, you can change the spin speed (in rpm; revolutions per minute) before and during the programme.

Setting 0: The rinsing water is drained but there is no final spin. The laundry stays wet inside the drum, e.g. for items that should not be spun.

Setting - -: (Rinse Stop) = no final spin. The laundry stays in the water after the final rinse.

You can select "Rinse Stop" to prevent creasing if the laundry will not be taken out of the washing machine immediately after the program has ended.

To continue/end the program see
→ Page 27

Note: The maximum speed that can be set depends on the model and programme that has been selected.

Finish in

Before starting the programme, you can preselect the programme end ("Ready in" time) in hourly increments (h = hour) up to a maximum of 24 hours.



To do this:

1. Select a programme.
The programme duration is displayed for the selected programme, e.g. **2:30** (hours:minutes).
2. Press the **Finish in**  button repeatedly until the required number of hours is displayed.
3. Press the  button.
The door will be locked.
The selected number of hours (e.g. **8 h**) is shown in the display panel and counts down until the wash programme starts. The duration of the programme is then displayed.

Note: The programme duration is included in the selected "Ready in" time.

During the timer count-down, you can change the preselected number of hours as follows:

1. Press the  button.

2. Use the **Finish in**  button to change the number of hours.
3. Press the  button.

During the timer count-down you can add or remove laundry as required.

Note: The length of the programme is automatically adjusted when the programme is running. Certain factors can affect the programme length, e.g.:

- Programme settings,
- Detergent dosage (additional rinse cycles if required due to foaming),
- Load size/type of textiles (longer washing for higher load and for textiles which absorb more water),
- Imbalances (e. g. due to fitted sheets) are offset with several start-ups of spin cycles,
- Fluctuations in power supply,
- Water pressure (infeeding speed).

P+ Additional programme settings

The available settings vary depending on the model.

You can find an overview of all settings available for selection in each programme on the supplementary sheet for the operating and installation instructions.

speed/eco

Button with two possible settings for adapting the selected programme:

- **speed**
Washing in a shorter time while achieving a washing result that is consistent with, but uses more energy than, the selected programme, without the speed setting.
Note: Do not exceed the maximum load.
- **eco**
Energy-optimised washing by reducing the temperature and increasing programme duration while achieving a washing result that is consistent with the selected programme, without the eco setting.

If you press the **speed/eco** button once, you select the **speed** setting. If you press the button again, the **eco** setting is activated. The respective symbol is shown in the display when the setting is activated. If you press the button again, no setting is activated.

Rinse+

Setting depending on the model

Increased water level and additional rinse cycle; extended washing time. For areas with very soft water or for further enhancing the spin result.

Less Iron

Setting depending on the model

Reduces creasing thanks to a special spin sequence followed by fluffing and reduced spin speed.

Note: The laundry's residual moisture is increased.

Prewash

Setting depending on the model

For heavily soiled laundry.

There will be a prewash cycle at a low temperature before the main wash cycle.

Note: Pour detergent into compartment **I** for the prewash cycle and into compartment **II** for the main wash cycle.



Operating the appliance

Preparing the washing machine

Notes

- The washing machine **must be correctly installed and connected.**
→ "Positioning and connecting" on page 10
 - Before washing for the first time, run a wash cycle without laundry.
→ "Before washing for the first time" on page 15
1. Connect the mains plug.
 2. Turn on the water tap.
 3. Open the door.
 4. Check that the drum is completely drained. Drain if necessary.

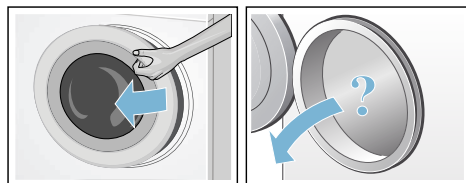

Select programme/switch on the appliance

Note: If you have activated the childproof lock, you must first deactivate it before you can set a programme.
→ "Childproof lock" on page 26

Use the programme selector to select the required programme. The programme selector can be rotated in either direction.

The appliance is switched on.

The **programme default settings** for the selected programme appear in the display panel:

- The maximum load and the duration of the programme (alternately)

Note: The maximum load appears only when the door is opened.

Change the programme default settings

You can use the default settings or change them.

To do this, repeatedly select the corresponding button until the required setting is displayed.

The settings are activated without needing to be confirmed.

They are not saved when the appliance is switched off.

→ "Programme default settings" on page 21

Overview of programmes → Supplementary sheet for the operating and installation instructions.

Select additional programme settings

By selecting additional settings, you can better adapt the washing process to your items of laundry.

The settings can be selected or deselected depending on the programme progress.

The indicator lamp for the button lights up if a setting is active.

The settings are not saved when the appliance is switched off.

→ "Additional programme settings" on page 23

Overview of programmes → Supplementary sheet for the operating and installation instructions.

Placing laundry into the drum

Warning **Risk of death!**

Items of laundry pretreated with cleaning agents that contain solvents, e.g. stain remover/cleaning solvent, may cause an explosion after being loaded into the washing machine. Hand-rinse items of laundry thoroughly beforehand.

Notes

- Mix items of laundry of varying sizes. Laundry items of different sizes distribute themselves better during the spin cycle. Individual items of laundry may lead to imbalances.
 - Observe the specified maximum load. Overfilling has a negative impact on the washing result and promotes creasing.
1. Place presorted items of laundry unfolded in the washing drum.
 2. Make sure that no items of laundry are trapped between the washing machine door and the rubber seal, and close the door.

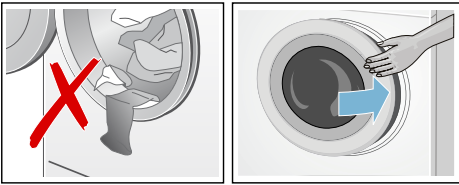

The  button indicator lamp flashes to indicate that the washing programme can be started. It is possible to change the settings.

→ "Programme default settings"
on page 21

→ "Additional programme settings"
on page 23

Measure and add detergent and care products

Caution! **Damage to the appliance**

Cleaning agents and agents for pre-treating laundry (e.g. stain removers, prewash sprays, etc.) may cause damage if they come into contact with the surfaces of the washing machine. Do not allow these agents to come into contact with the surfaces of the washing machine. If necessary, immediately wipe away spray residue and other residues/droplets with a damp cloth.

Dosing

Dose the detergents and care products according to:

- Water hardness (ask your water supply company)
- The manufacturer's instructions on the packaging
- The amount of laundry
- Soiling

Filling

Warning **Eye/skin irritation!**

Detergents and care products may spray out if the detergent drawer is opened while the machine is in operation.

Open the drawer carefully. Rinse eyes/skin thoroughly if they come into contact with detergents or care products.

If accidentally swallowed, seek medical advice.

Note: Dilute viscous fabric softener and fabric conditioner with a little water. This prevents blockages in the washing machine's piping.

Pour the detergent and care products into the appropriate compartments:

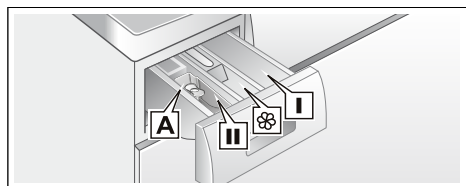

- Measuring aid **A*** For liquid detergent
 Compartment **II** Detergent for the main wash, water softener, bleach, stain remover
 Compartment **⊗** Fabric softener, liquid starch; do not exceed **max.**
 Compartment **I** Detergent for pretreat and clothing disinfectant. (only for the appliance with pretreat and disinfectant function)

* depending on the model

1. Pull out the detergent drawer as far as possible.
2. Add detergent and/or care products.
3. Close the detergent drawer.

Measuring aid* for liquid detergent

Position the measuring aid for dosing the correct amount of liquid detergent:

1. Pull out the detergent drawer. Insert the measuring aid into compartment II for main wash.
2. Pour liquid detergent into measuring aid and do not exceed the maximum mark.
3. Reinsert the drawer.

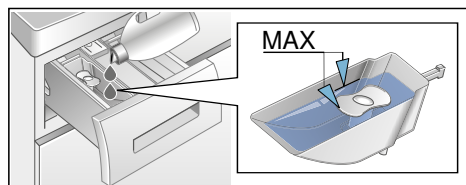

* depending on the model

Note: Do not use the measuring aid for gel detergents.

For models without a measuring aid, pour the liquid detergent into the appropriate dispenser and place it in the drum.

Starting the programme

Press the ▶ button. The indicator lamp lights up and the programme starts.

The display panel shows the “Ready in” time while the programme is running or the programme duration and the programme progress symbols once the wash cycle has started.

→ "Display panel" on page 17

Childproof lock

🔒 3 sec.

You can lock the washing machine to prevent the functions you have set from being changed inadvertently.

To **activate/deactivate**, press and hold the **rpm** Ⓞ and **Finish in** ⌚ buttons at the same time for approx. three seconds. The 🔒 symbol appears in the display panel.

- 🔒 lights up: The childproof lock is active.
- 🔒 flashes: The childproof lock is active and the programme selector has been adjusted. If you reset the programme selector to the initial programme, the symbol lights up again.

Notes

- If the appliance is switched off while the programme is running and childproof lock is activated, the programme continues when the appliance is switched back on.
- To remove the laundry at the end of the programme, deactivate the childproof lock.

- The childproof lock remains active, even once the washing machine has been switched off.

Adding/removing laundry

After starting the programme, you can add or remove laundry as required.

Press the ▷ button to pause the programme. The ▷ button indicator lamp flashes and the machine checks whether it is possible to add or remove laundry.

- If the  symbol disappears in the display panel, the washing machine door is unlocked. You can add or remove laundry.

Notes

- Do not leave the door open for too long when adding/removing laundry as water from the laundry may leak out.
- The load display is not active during reloading.

Press the ▷ button to continue the programme.

- If the  symbol lights up in the display panel, it is not possible to add or remove laundry.

Note: For safety reasons, the door remains locked when the water level or temperature is high, or while the drum is turning.

Changing the programme

If you have started the wrong programme by mistake, you can change it as follows:

1. Press the ▷ button.
2. Select another programme.
3. Press the ▷ button. The new programme starts from the beginning.

Cancelling the programme

For programmes at high temperature:

1. Press the ▷ button.
2. To cool down laundry: Select **Rinse**.
3. Press the ▷ button.

For programmes at low temperature:

1. Press the ▷ button.
2. Select **Spin/Empty**.
3. Press the ▷ button.

Programme end during Rinse Stop

- - appears in the display panel and the indicator lamp of the ▷ button flashes.

Continue the programme by:

- Pressing the ▷ button (the laundry will be spun with the default spin speed setting*) or
- Selecting a spin speed or setting the programme selector to **Spin/Empty** and then pressing the ▷ button.

Programme end

End appears in the display panel and the indicator lamp of the ▷ button is off.

* depending on the chosen programme → Overview of programmes on supplementary sheet for the operating and installation instructions

Removing laundry/switching off the appliance

1. Turn the program selector to off position. The appliance is switched off.
2. Turn off the tap. Disconnect the mains cable.
3. Open the door and remove the laundry.

Notes

- Always wait until the program ends, as the appliance could still be locked.
- If the display panel goes off at the end of a program, the energy-saving mode is active. Press any button to activate the panel.
- Do not leave any items of laundry in the drum. They may shrink in the next wash or discolour another item.
- Remove any foreign objects from the drum and the rubber seal – risk of rusting.
- Wipe the rubber seal dry.

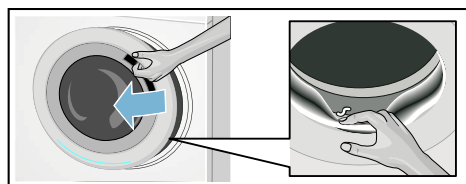

- Leave the door and detergent drawer open so that any residual water can evaporate.

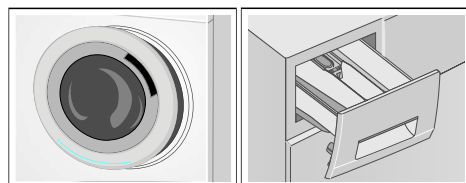

Appliance settings

You can change the following settings:

- The volume of the information signals (e.g. at the end of the programme) and/or
- The volume of the button signals and/or
- Switch on or off the drum clean reminder*.

In order to change these settings you will need to activate the setting mode.

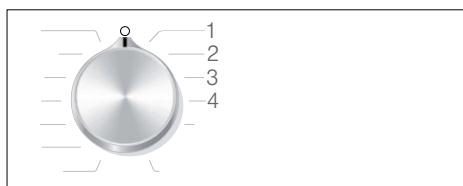

1/2/3/4... positions on the programme selector

Activating the setting mode

1. Turn the programme selector to position 1. The washing machine is switched on.
2. Press the >||| button and, at the same time, turn the programme selector clockwise to position 2. Release the button.

The setting mode is activated and the preset volume for the information signals appears in the display panel (e.g. at the end of the programme).

Changing the volume

- To change the volume of the **information signals**, use the **Finish in** ⌚ button while the programme selector remains at position 2.
- To change the volume of the **button signals**, rotate the programme selector to position 3. Use the **Finish in** ⌚ button again to change the volume.

* depending on the model

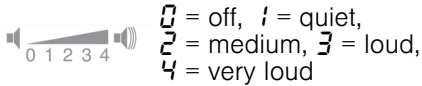

Switching on or off the drum clean reminder*

To switch on/off the drum clean reminder, rotate the programme selector to position 4. Use the **Finish in**  button to switch the reminder on or off.



If the setting is activated, an acoustic signal is heard.

Exiting setting mode

You can now end the process and set the programme selector to the off position. The settings are saved.

Cleaning and maintenance

Warning

Risk of death!

There is a risk of electric shock if you touch live components. Switch off the appliance and disconnect the mains plug.

Warning

Risk of poisoning!

Toxic vapours can be produced by cleaning agents that contain solvents, e.g. cleaning solvent. Do not use cleaning agents that contain solvents.

Caution!

Damage to the appliance

Cleaning agents that contain solvents, e.g. cleaning solvent, can damage surfaces and components in the machine. Do not use cleaning agents that contain solvents.

Prevent detergent residue from building up and odours from forming by following these instructions:

Notes

- Ensure the room in which the washing machine is set up is well ventilated.
- Leave the door and detergent drawer open slightly when the washing machine is not in use.
- Occasionally run a wash using the **Cottons 60 °C** programme with washing powder.

* depending on the model

Machine housing/control panel

- Wipe the housing and the control panel with a soft, damp cloth.
- Remove the detergent residue immediately.
- Do not clean with a water jet.

Drum

Use chlorine-free cleaning agents, do not use steel wool.

If there are odours in the washing machine, or to clean the drum, run the **Drum Clean** programme or **Cottons 90 °C** programme* without laundry.

Descaling

Descaling should not be necessary if the detergent is measured out correctly. However, if it is required, follow the manufacturer's instructions for the descaling agent. Suitable descalers can be obtained via our website or from our after-sales service. → Page 35

Detergent drawer and housing

If the washing machine contains detergent or fabric softener residues:

1. Pull out the detergent drawer. Press down the insert and fully remove the drawer.
2. To remove the insert: Push the insert upwards from below with your finger.

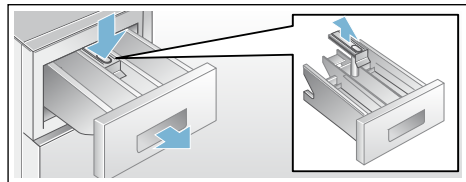

3. Clean the detergent dispenser tray and insert with water and a brush, and dry it. Clean the inside of the housing as well.
4. Fit the insert and lock it in place (push the cylinder onto the guide pin).
5. Push in the detergent drawer.

Note: Leave the detergent drawer open so that any residual water can evaporate.

Cleaning the measuring aid A** for liquid detergent

If it contains liquid detergent residue:

1. Hold the measuring aid, pull the cover upward and disconnect them.

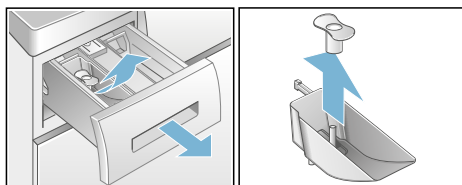

2. Clean the measuring aid and cover with water and brush.

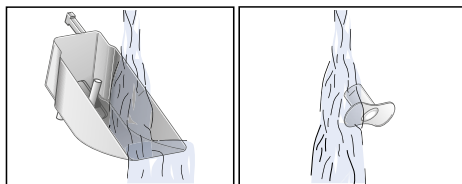

3. Install the cover back to the measuring aid. Pay attention to the assemble mark, and press the cover until click sounds.

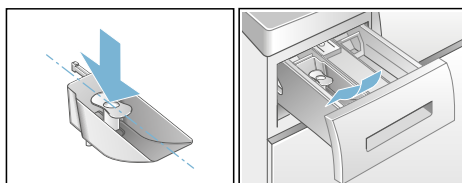

* depending on the model

** depending on the model

Detergent solution pump blocked

Note: Turn the tap off to prevent more water from flowing in and to ensure that it is drained via the pump.

Warning **Risk of scalding!**

Washing water is hot when washing at high temperatures. You may be scalded if you touch the hot washing water. Allow the washing water to cool down.

1. Pull out the mains plug.
2. Open and remove the maintenance cover.

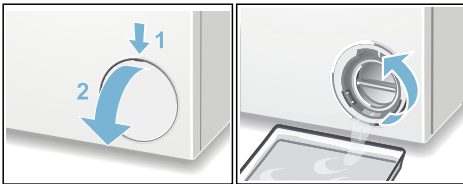

3. Carefully unscrew the pump cover - do not remove it completely. Let the water drain into a shallow container. Repeat the operation until there is no water left.
4. Remove the pump cover. Remove foreign material/fluff from inside the pump. Clean the interior, pump cover thread and pump housing (the fan impeller in the detergent-solution pump must be able to rotate).

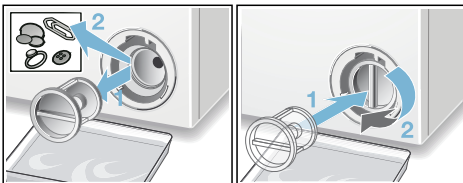

5. Refit the pump cover, ensuring it fits tightly. Handle should be vertical.
6. Insert the maintenance cover and close it.

Note: To prevent unused detergent from flowing into the outlet during the next wash: Pour 1 litre of water into dispenser **II** and start the **Spin/Empty** programme.

The drain hose at the siphon is blocked

1. Switch off the appliance. Disconnect the mains plug.
2. Loosen the hose clamp. Carefully remove the drain hose; residual water may leak out.
3. Clean the drain hose and siphon connecting piece.

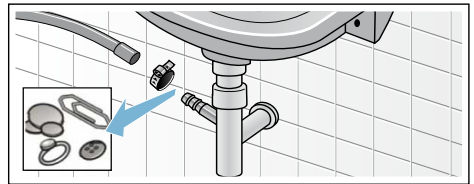

4. Reattach the drain hose and secure the connection using the hose clamp.

Filter in the water supply is blocked

First, reduce the water pressure in the supply hose:

1. Turn off the tap.
2. Select any program (except Spin/Empty).
3. Press the  button. Allow the program to run for approximately 40 seconds.
4. Turn the program selector to off position. Pull out the mains plug.
5. Clean the filter on the tap: Disconnect the hose from the tap. Clean the filter with a small brush.

en Faults and what to do about them

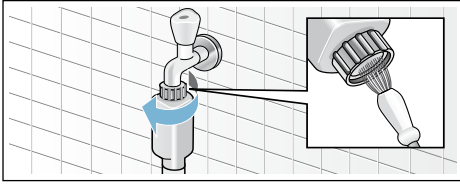

6. Remove the hose from the rear of the appliance.
Use pliers to remove the filter and then clean it.

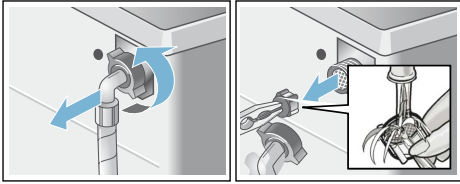

7. Insert the filter, connect the hose and check for leaks.

? Faults and what to do about them

Emergency release

e.g. in the event of a power outage

Note: The programme will continue running when the power supply has been restored.

Warning **Risk of scalding!**

When you are washing at high temperatures, there is a risk of scalding if you come into contact with detergent solution and laundry.
If possible, leave it to cool down.

Warning **Risk of injury!**

You may injure your hands if you reach into the drum while it is turning.

Do not reach into the drum when it is turning. Wait until the drum has stopped turning.

Caution! **Water damage**

Any escaping water may cause water damage. Do not open the washing machine door if water can be seen through the glass.





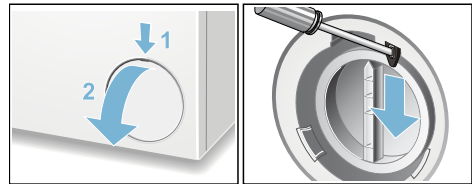



If the laundry has to be removed, the washing machine door can be opened as follows:

1. Pull out the mains plug.
2. Open and remove the service flap.
3. Insert the cross-head screwdriver into the emergency release. Pull it downwards to the end (not less than 1 cm).



4. Release it.
5. The washing machine door can now be opened.

Information on the display panel

Display	Cause/remedy
 lights up	<ul style="list-style-type: none"> ■ The temperature is too high. Wait until the temperature drops. ■ The water level is too high. It is not possible to add laundry. Run the Spin/Empty programme to reduce the water level, if necessary.
 flashes	<ul style="list-style-type: none"> ■ Laundry may be caught. Open and close the door again and press the  button. ■ If necessary, push the door closed or remove some laundry and then push it closed again. ■ If necessary, switch the appliance off and on again; set the programme and make your individual settings; start the programme.
 lights up	The water pressure is too low.
 flashes	<ul style="list-style-type: none"> ■ Turn on the cold water tap fully, ■ Supply hose kinked/trapped, ■ Clean the filter. → <i>Page 31</i>
E : 18	<ul style="list-style-type: none"> ■ The drain pump is blocked. Clean the drain pump. → <i>Page 31</i> ■ The drain hose/drain pipe is blocked. Clean the drain hose at the siphon. → <i>Page 31</i>
E : 32	Alternating display with End when programme is finished, indicating the laundry inside are unbalanced. The washing machines' unbalanced load detection system can not adjust the imbalance. To protect the mechanical systems, the machine will not achieve the highest spin speed, and the laundry can not be spinned completely. Please wash small and large items of laundry together.
	The childproof lock is activated – deactivate it.
 * lights up	Too much foam has been detected and an additional wash cycle has been activated. Add less detergent to the next washing cycle with the same load.
The indicator light  for the Drum Clean programme* flashes	<p>Run the Drum Clean programme or a 60 °C programme to clean and care for the drum and the outer tub.</p> <p>Notes</p> <ul style="list-style-type: none"> ■ Run the programme without laundry. ■ Switching the information signal on/off → <i>Page 28</i>
Other displays	Switch off the appliance, wait for five seconds and then switch it on again. If the display appears again, call the after-sales service. → <i>Page 35</i>
* depending on the model	

Faults and what to do about them

Faults	Cause/Remedy
Water is leaking from the appliance.	<ul style="list-style-type: none"> ■ Attach the drain hose correctly or replace it. ■ Tighten the screw connection of the supply hose.
The machine is not filling with water.	<ul style="list-style-type: none"> ■ Have you pressed the ▷ button? ■ Is the tap turned on?
Detergent is not being dispensed.	<ul style="list-style-type: none"> ■ Could the filter be clogged? Clean the filter. → Page 31 ■ Is the supply hose kinked or trapped? ■ Is there water in the drum?
The door cannot be opened.	<ul style="list-style-type: none"> ■ The programme does not end normally. Select any programme. ■ Is - - selected (Rinse Stop = no final spin)? ■ Can the door only be opened by the emergency release? → Page 32
The program will not start.	<ul style="list-style-type: none"> ■ Have you pressed the ▷ or Finish in ☺ button? ■ Is the door closed correctly? ■ Is the ☹ childproof lock activated? Deactivate.
The additional function could not be activated for the selected programme.	<p>Can the additional option be selected?</p> <p>Overview of programmes → Supplementary sheet for the operating and installation instructions.</p>
The water is not draining.	<ul style="list-style-type: none"> ■ Is - - selected (Rinse Stop = no final spin)? ■ Clean the drain pump. → Page 31 ■ Clean the drain pipe and/or the drain hose. → Page 31
Water is not visible in the drum.	Not a fault – the water is below the visible area.
The spin result is not satisfactory. Laundry is wet/too damp.	<ul style="list-style-type: none"> ■ Not a fault – the unbalanced load detection system has interrupted the spin cycle because the laundry is unevenly distributed. Distribute small and large items of laundry evenly in the drum. ■ Less Iron* selected? ■ Is the selected speed too low?
The spin cycle runs several times.	Not a fault – the unbalanced load detection system is adjusting an imbalance.
The programme duration changes during the wash cycle.	<ul style="list-style-type: none"> ■ Not a fault – the unbalanced load detection system is adjusting an imbalance by repeatedly distributing the laundry. ■ Not a fault – the foam detection is system active – a rinse cycle has been switched on.
Residual water in the compartment ☹.	Remove the insert. Clean detergent drawer and re-insert → Page 30
Residual detergent in the detergent dispenser	<ul style="list-style-type: none"> ■ Detergent is damp or lumpy, clean the detergent dispenser. ■ Use the dosing aid for liquid detergent.

* depending on the model

Faults	Cause/Remedy
The  * symbol lights up in the display panel. Foam may also be leaking from the detergent drawer.	Have you used too much detergent? Mix one tablespoon of fabric softener with 1/2 litre of water and pour it into compartment II (not suitable for outdoor clothing, sportswear or items stuffed with down). Use less detergent in the next wash cycle.
Loud noises, vibrations and machine "movement" during the spin cycle.	<ul style="list-style-type: none"> ■ Is the appliance aligned? Align the appliance. → <i>Page 14</i> ■ Have the transport bolts been removed? Remove the transport bolts. → <i>Page 11</i>
The display panel/indicator lights do not work while the appliance is running.	<ul style="list-style-type: none"> ■ Has there been a power failure? ■ Have the fuses blown? Reset/replace the fuses. ■ If the fault occurs repeatedly, call customer services. → <i>Page 35</i>
There is detergent residue on the laundry.	<ul style="list-style-type: none"> ■ Some phosphate-free detergents contain water-insoluble residue. ■ Select Rinse or brush the laundry after washing.
If you cannot rectify a fault yourself (after switching the machine off and on again) or a repair is required:	
<ul style="list-style-type: none"> ■ Switch off the appliance and pull out the mains plug. ■ Turn off the tap and call customer services. → <i>Page 35</i> 	
* depending on the model	



After-sales service

If you cannot rectify a fault yourself, please contact our after-sales service.

We will always find an appropriate solution to avoid unnecessary visits by engineers.

Please provide the after-sales service with the product number (E no.) and the production number (FD) of the appliance.

E-Nr. _____ FD _____

E no. Product number
FD Production number

You can find this information:

- On the inside of the loading door

- On the back of the appliance

Trust the expertise of the manufacturer. Contact us. By doing so, you can be sure that the repairs are carried out by trained service personnel using genuine spare parts.

Repair order and advice in the event of faults

GB 0344 892 8999 (Calls charged at local or mobile rate.)

IE 01450 2655 (0.03 € per minute at peak. Off peak 0.0088 € per minute.)

You can find the contact information for all countries in the attached after-sales service directory.

BSH Hausgeräte GmbH

Carl-Wery-Straße 34

81739 München

GERMANY

siemens-home.bsh-group.com

Manufactured by BSW HOUSEHOLD APPLIANCES CO., LTD. under Trademark License of Siemens AG



9001319606 (9706)