

Gaggenau

Use and care manual

# **BMP 250/251 710**

Combi-microwave oven

**SAVE THESE INSTRUCTIONS  
FOR FUTURE REFERENCE.**

**CONSERVEZ CETTE NOTICE  
D'UTILISATION POUR  
RÉFÉRENCE ULTÉRIEURE.**

---

# Table of Contents

---

<b>Safety Definitions</b>	<b>4</b>	<b>Microwave</b>	<b>24</b>
<b>IMPORTANT SAFETY INSTRUCTIONS</b>	<b>5</b>	Notes regarding cookware	24
<b>⚠ PRECAUTIONS TO AVOID POSSIBLE EXPOSURE TO EXCESSIVE MICROWAVE ENERGY</b>	<b>5</b>	Microwave output	24
<b>GROUNDING INSTRUCTIONS</b>	<b>7</b>	Setting the microwave	24
TV / Radio Interference	8	<b>Oven</b>	<b>25</b>
Intended Use	9	Setting the type of heating and temperature	26
Child Safety	9	Quick heat	26
Cleaning Safety	9	Safety shut-off	26
Cooking Safety	10	<b>Broil</b>	<b>27</b>
In Case of Fire	11	Setting the Broil mode	27
Liquids	11	<b>Combination mode</b>	<b>27</b>
Cooking Items	12	Setting the combination mode	27
Cooking Utensils	15	<b>Sequential operation</b>	<b>28</b>
Thermometers	15	Setting a series of operations	28
Pacemakers	15	End of cooking time	29
Fan Motor Operation	16	<b>Automatic programs</b>	<b>30</b>
<b>Causes of damage</b>	<b>17</b>	Setting a program	30
<b>Protecting the environment</b>	<b>17</b>	Adjust individually	31
Tips for saving energy	17	Tips for automatic programs	31
<b>Getting to know the appliance</b>	<b>18</b>	Program table	32
Displays and controls	18	<b>Personal recipes</b>	<b>34</b>
Function selector positions	18	Recording a recipe	34
Symbols	18	Programming a recipe	35
Colors and display	19	Entering a name	35
Additional information <b>i</b>	19	Starting a recipe	35
Cooling fan	19	Change recipe	36
Accessories	20	Deleting a recipe	36
<b>Before first use</b>	<b>21</b>	<b>Timer functions</b>	<b>36</b>
Setting the language	21	Launching the timer menu	36
Setting the time format	22	Timer	37
Setting the time	22	Stopwatch	37
Setting the date format	22	<b>Sabbath mode</b>	<b>38</b>
Setting the date	22	<b>Child lock</b>	<b>38</b>
Setting the temperature format	22	Activating the child lock	38
Completing initial set-up	23	Deactivating the child lock	38
Heating up the oven	23	<b>Basic Settings</b>	<b>39</b>
Cleaning accessories	23	<b>Cleaning</b>	<b>41</b>
<b>Activating the appliance</b>	<b>23</b>	Self-cleaning surface in the cooking compartment	42
Standby	23	Cleaning agent	42
Activate appliance	23		

<b>Troubleshooting</b>	<b>44</b>
Power cut	45
Demo mode	45
<b>Technical specifications</b>	<b>45</b>
<b>Customer service</b>	<b>46</b>
<b>Tables and tips</b>	<b>47</b>
Defrosting	47
Defrosting, heating up or cooking frozen food	49
Heating food	50
Cooking food	52
Microwave tips	53
Cakes and pastries	53
Baking tips	54
Roasting and grilling	55
Tips for roasting and grilling	57
Casseroles, gratins	58
Frozen convenience products	58
Test dishes	59
Acrylamide in foodstuffs	60

Additional information on products, accessories, replacement parts and services can be found at [www.gaggenau.com](http://www.gaggenau.com) and in the online shop [www.gaggenau.com/zz/store](http://www.gaggenau.com/zz/store)

---

## Safety Definitions

---

---

### **WARNING**

---

This indicates that death or serious injuries may occur as a result of non-observance of this warning.

---

---

### **CAUTION**

---

This indicates that minor or moderate injuries may occur as a result of non-observance of this warning.

---

---

### **NOTICE**

---

This indicates that damage to the appliance or property may occur as a result of non-compliance with this advisory.

---

**Note:** This alerts you to important information and/or tips.

---

#### **Protective earth (ground)**



To identify any terminal which is intended for connection to an external conductor for protection against electric shock in case of a fault, or the terminal of a protective earth (ground) electrode.

---



---

#### **Heavy load**

Requires 2 people to carry

---

---

## Définitions de sécurité

---

---

### **AVERTISSEMENT**

---

Ceci indique que le non-respect de cet avertissement peut entraîner des blessures graves, voire la mort.

---

---

### **ATTENTION**

---

Ceci indique que le non-respect de cet avertissement peut entraîner des blessures légères ou de gravité moyenne.

---

---

### **AVIS**

---

Ceci indique que la non-conformité à cet avis de sécurité peut entraîner des dégâts matériels ou endommager l'appareil.

---

**Remarque :** Ceci vous signale des informations et/ou indications importantes.

---

#### **Terre de protection**



Pour marquer les bornes destinées à être raccordées à un conducteur de protection extérieur contre les chocs électriques en cas de défaut d'isolement, ou pour marquer la borne de la terre de protection.

---



---

#### **Charge lourde**

Nécessite 2 personnes pour le déplacement.

---

# **IMPORTANT SAFETY INSTRUCTIONS**

READ ALL INSTRUCTIONS BEFORE USING THE APPLIANCE

# **CONSIGNES DE SÉCURITÉ IMPORTANTES**

LISEZ TOUTES LES INSTRUCTIONS AVANT D'UTILISER L'APPAREIL

---

## **WARNING**

Before installing, turn power OFF at the service panel. Lock service panel to prevent power from being turned ON accidentally.

---

**SAVE THESE INSTRUCTIONS FOR FUTURE REFERENCE.**

## **PRECAUTIONS TO AVOID POSSIBLE EXPOSURE TO EXCESSIVE MICROWAVE ENERGY**

(1) Do not attempt to operate this oven with the door open, since open-door operation can result in harmful exposure to microwave energy. It is important not to defeat or tamper with the safety interlocks.

(2) Do not place any object between the oven front face and the door or allow soil or cleaner residue to accumulate on sealing surfaces.

(3) Do not operate the oven if it is damaged. It is particularly important that the oven door close properly and that there is no damage to the:

- door (bent)
- hinges and latches (broken or loosened)
- door seals and sealing surfaces.

(4) The oven should not be adjusted or repaired by anyone except properly qualified service personnel. Improper installation, service or maintenance can cause injury or property damage. Refer to this manual for guidance. Refer all servicing to a factory authorized service center.

---

## **WARNING**

 To reduce the risk of burns, electric shock, fire, injury to persons, or exposure to excessive microwave energy, read all instructions before using the appliance.

---

---

## **AVERTISSEMENT**

Avant l'installation, couper le courant au panneau de service. Verrouiller le panneau de service pour éviter que le courant ne soit accidentellement rétabli.

---

**CONSERVEZ CETTE NOTICE D'UTILISATION POUR RÉFÉRENCE ULTÉRIEURE.**

## **MESURES DE PRÉCAUTION POUR ÉVITER L'EXPOSITION EXCESSIVE À L'ÉNERGIE MICRO-ONDE**

(1) Lorsque vous faites fonctionner l'appareil, ne laissez pas la porte du four ouverte car l'exposition à l'énergie micro-onde peut être nocive. Il est important de ne pas endommager les verrous de sécurité et de ne pas essayer de les forcer.

(2) Aucun objet ne doit empêcher la porte du four de bien se refermer et ne laissez pas les résidus d'aliments ou de produit d'entretien s'accumuler sur les joints d'étanchéité.

(3) Ne faites pas fonctionner le four s'il est endommagé. Il est particulièrement important que la porte du four puisse être refermée correctement, et donc que les pièces suivantes ne soient pas endommagées:

- porte (bosselée)
- charnières et loquets (brisés ou desserrés)
- joints de porte et surfaces d'étanchéité.

(4) Confier toute réparation ou réglage uniquement à un personnel d'entretien qualifié. Toute installation, réparation ou maintenance inadéquate peut entraîner des blessures ou des dommages matériels. Se reporter à ce manuel pour obtenir des conseils sur la façon de procéder. Toute réparation doit être confiée à un centre de service agréé par l'usine.

---

## **AVERTISSEMENT**

 Pour réduire le risque de brûlures, de chocs d'électrocution, de feu, de blessures ou d'exposition à une énergie micro-ondes excessive, lisez toutes les instructions avant d'utiliser l'appareil.

---



# IMPORTANT SAFETY INSTRUCTIONS

READ ALL INSTRUCTIONS BEFORE USING THE APPLIANCE



# CONSIGNES DE SÉCURITÉ IMPORTANTES

LISEZ TOUTES LES INSTRUCTIONS AVANT D'UTILISER L'APPAREIL

---

## WARNING

---

 If the information in this manual is not followed exactly, fire or shock may result causing property damage or personal injury.

---

**When using electrical appliances basic safety precautions should be followed, including the following:**

Read and follow the specific "PRECAUTIONS TO AVOID POSSIBLE EXPOSURE TO EXCESSIVE MICROWAVE ENERGY" found in the Safety Instructions chapter.

This appliance must be grounded. Connect only to properly grounded outlet (see **GROUNDING INSTRUCTIONS**).

Install or locate this appliance only in accordance with the provided installation instructions.

Be sure your appliance is properly installed and grounded by a qualified technician. Installation, electrical connections and grounding must comply with all local and regional codes.

Some products such as whole eggs and sealed containers – for example, closed glass jars – are able to explode and should not be heated in this oven.

Use this appliance only for its intended use as described in the manual. Do not use corrosive chemicals or vapors in this appliance. This type of oven is specifically designed to heat, cook, or dry food. It is not designed for industrial or laboratory use.

**HOT CONTENTS CAN CAUSE SEVERE BURNS. DO NOT ALLOW CHILDREN TO USE THE MICROWAVE.** Use caution when removing hot items. (see **CHILD SAFETY**)

This appliance should be serviced only by qualified service personnel. Contact nearest authorized service facility for examination, repair, or adjustment.

Do not cover or block any vents or openings on the appliance.

---

## AVERTISSEMENT

---

 Si les informations contenues dans ce manuel ne sont pas suivies à la lettre, un incendie ou un choc électrique peuvent se produire et entraîner des dommages matériels ou des préjudices personnels.

---

**Quand vous utilisez des appareils électriques, observez les consignes de sécurité de base, y compris ce qui suit :**

Lisez et observez les précautions spécifiques «**POUR ÉVITER L'EXPOSITION POSSIBLE À UNE ÉNERGIE MICRO-ONDES EXCESSIVE**» que vous trouverez dans le chapitre Consignes de sécurité.

Cet appareil doit être mis à la terre. Raccordez l'appareil uniquement à une prise de courant correctement mise à la terre (voyez **INSTRUCTIONS DE MISE À LA TERRE**).

Installez ou aménagez cet appareil uniquement en conformité avec les instructions d'installation fournies.

Assurez-vous que l'appareil est correctement installé et mis à la terre par un technicien qualifié. L'installation, les raccordements électriques et la mise à la terre doivent être conformes avec tous les codes locaux et régionaux applicables.

Certains produits comme des œufs entiers et des contenants scellés – par exemple, des pots en verre scellés – peuvent éclater et ne doivent pas être chauffés dans ce four.

Utilisez cet appareil uniquement dans le cadre de l'utilisation prévue tel que décrit dans ce manuel. N'utilisez pas de produits chimiques corrosifs ou des vapeurs dans cet appareil. Ce type de four est conçu spécifiquement pour chauffer, pour cuire ou pour sécher les aliments. Il n'est pas conçu pour un usage industriel ou en laboratoire.

**LE CONTENU CHAUD PEUT CAUSER DE GRAVES BRÛLURES. NE PERMETTEZ PAS AUX ENFANTS D'UTILISER LE MICRO-ONDES.** Soyez prudent lorsque vous retirez des éléments chauds. (Voir **SÉCURITÉ DES ENFANTS**)

L'entretien de cet appareil doit être confié uniquement à un personnel de service qualifié. Contactez le centre de service autorisé le plus proche pour un examen, une réparation ou un réglage.

Ne couvrez pas ou bloquez les événements ou ouvertures de l'appareil.



## IMPORTANT SAFETY INSTRUCTIONS

READ ALL INSTRUCTIONS BEFORE USING THE APPLIANCE



## CONSIGNES DE SÉCURITÉ IMPORTANTES

LISEZ TOUTES LES INSTRUCTIONS AVANT D'UTILISER L'APPAREIL

Do not store this appliance outdoors. Do not use this product near water – for example, near a kitchen sink, in a wet basement, near a swimming pool, or similar locations. Appliance is only for indoor and household use.

When cleaning surfaces of door and oven that come together on closing the door, use only mild, nonabrasive soaps, or detergents applied with a sponge or soft cloth. See door surface cleaning instructions in chapter “Cleaning and Maintenance”.

### To reduce the risk of fire in the oven cavity:

- Do not overcook food. Carefully attend appliance when paper, plastic, or other combustible materials are placed inside the oven to facilitate cooking.
- Remove wire twist-ties from paper or plastic bags before placing bag in oven.
- If materials inside the oven ignite, keep oven door closed, turn oven off, and disconnect the power cord, or shut off power at the fuse or circuit breaker panel.
- Do not use the cavity for storage purposes. Do not leave paper products, cooking utensils, or food in the cavity when not in use.



## GROUNDING INSTRUCTIONS

This appliance must be grounded. Grounding reduces the risk of electric shock by providing a safe pathway for electric current in the event of a short circuit.

The appliance must be connected to a grounded, metallic, permanent wiring system, or an equipment grounding conductor should be run with the circuit conductors and connected to the equipment grounding terminal or lead on the appliance.

Ne rangez pas cet appareil à l'extérieur. N'utilisez pas ce produit à proximité de l'eau – par exemple, près d'un évier de cuisine, dans un sous-sol humide, près d'une piscine ou d'emplacements similaires. L'appareil est conçu uniquement pour un usage domestique et à l'intérieur.

Lors du nettoyage des surfaces de la porte et du four qui se joignent ensemble à la fermeture de la porte, utilisez seulement des savons ou des détergents légers, non abrasifs appliqués avec une éponge ou un chiffon doux. Voyez les directives de nettoyage des surfaces de porte dans le chapitre «Nettoyage et entretien».

### Pour réduire le risque de feu dans la cavité du four :

- Ne cuisez pas trop les aliments. Surveillez attentivement l'appareil quand des matériaux en papier, plastique et autres combustibles sont insérés à l'intérieur du four pour faciliter la cuisson.
- Retirez les attaches métalliques des sacs de papier ou de plastique avant de placer le sac dans le four.
- Si des matériaux à l'intérieur du four s'enflamment, gardez la porte du four fermée, éteignez le four et débranchez le cordon d'alimentation ou coupez l'alimentation au panneau de fusibles ou de disjoncteur.
- N'utilisez pas la cavité aux fins de rangement. Ne laissez pas des produits de papier, des ustensiles de cuisson ou des aliments dans la cavité lorsque celle-ci ne sert pas.



## INSTRUCTIONS DE MISE À LA TERRE

Cet appareil doit être mis à la terre. En cas de court-circuit électrique, la mise à la terre réduira le risque de choc électrique en offrant au courant électrique un fil d'évacuation.

Cet appareil doit être raccordé à un système de câblage métallique permanent avec mise à la terre ou un conducteur de mise à terre devrait être utilisé avec les conducteurs de circuit et raccordé au terminal de mise à la terre ou à la conduite sur l'appareil.



# IMPORTANT SAFETY INSTRUCTIONS

READ ALL INSTRUCTIONS BEFORE USING THE APPLIANCE



# CONSIGNES DE SÉCURITÉ IMPORTANTES

LISEZ TOUTES LES INSTRUCTIONS AVANT D'UTILISER L'APPAREIL

---

## WARNING

Improper grounding can result in a risk of electric shock. Consult a qualified electrician if the grounding instructions are not completely understood, or if doubt exists as to whether the appliance is properly grounded. Do not use an extension cord. If the power supply cord is too short, have a qualified electrician install an outlet near the appliance.

---

The models stated on the front cover are dual-rated, designed to be connected to either 208 or 240V AC, 60 Hz, four-wire or three-wire electrical system.

## TV / Radio Interference

This appliance generates and uses ISM frequency energy. If not installed and used properly, in strict accordance with the manufacturer's instructions, it may cause interference to radio and television reception. It has been type tested and found to comply with limits for ISM equipment pursuant to part 18 of FCC rules, which are designed to provide reasonable protection against such interference in a residential installation. However, there is no guarantee that interference will not occur in a particular installation. Turn the appliance on and off to determine if it causes interference. Try the following to correct the interference:

- Clean door and sealing surface of the oven.
- Reorient the receiving antenna of the radio or television.
- Relocate the microwave oven with respect to the receiver.
- Move the microwave oven away from the receiver.
- Plug the microwave into a different outlet so that the oven and the receiver are on different branch circuits.

The manufacturer is not responsible for any radio or TV interference caused by unauthorized modification to this microwave oven. It is the responsibility of the user to correct such interference.

---

## AVERTISSEMENT

Une mise à la terre inadéquate peut entraîner un risque d'électrocution. Consultez un électricien qualifié si vous ne comprenez pas parfaitement les instructions de mise à la terre ou si vous avez des doutes quant à la qualité de mise à la terre. N'utilisez pas de rallonge. Si le cordon d'alimentation est trop court, demandez à un électricien ou un technicien qualifié d'installer une prise à proximité de l'appareil.

---

Les modèles figurant sur la couverture avant sont à deux alimentations et sont conçus pour être raccordés à un système électrique 208 ou 240 V CA, 60 Hz à 4 fils ou à 3 fils.

## Interférences radio/télévision

Cet appareil génère et utilise de l'énergie à fréquence ISM. S'il n'est pas installé et utilisé correctement, en stricte conformité avec les directives du fabricant, il pourrait perturber la réception des ondes radio et télévision. Il a été testé et trouvé conforme avec les limites régissant les équipements ISM conformément à la partie 18 des règlements FCC, qui sont conçus pour fournir une protection raisonnable contre une telle interférence dans une installation résidentielle. Toutefois, il n'y a aucune garantie qu'une interférence ne se produira pas dans une installation particulière. Allumez et éteignez l'appareil pour déterminer s'il est à l'origine de l'interférence. Essayez les mesures suivantes pour corriger l'interférence :

- Nettoyez la porte et la surface d'étanchéité du four.
- Réorientez l'antenne réceptrice de la radio ou de la télévision.
- Relocalisez le four à micro-ondes par rapport au récepteur.
- Éloignez le four à micro-ondes du récepteur.
- Branchez le micro-ondes dans une prise différente de sorte que le four et le récepteur soient branchés sur des circuits différents.

Le fabricant n'est pas responsable de toute interférence radio ou télévision causée par une modification non autorisée de ce four à micro-ondes. C'est à l'utilisateur qu'il incombe de corriger une telle interférence.





# IMPORTANT SAFETY INSTRUCTIONS

READ ALL INSTRUCTIONS BEFORE USING THE APPLIANCE



# CONSIGNES DE SÉCURITÉ IMPORTANTES

LISEZ TOUTES LES INSTRUCTIONS AVANT D'UTILISER L'APPAREIL

## Intended Use

This appliance is intended for normal family household use only. It is not approved for outdoor use. See the Warranty. If you have any questions, contact the manufacturer.

Do not use the cavity for storage purposes. Do not leave paper products, cooking utensils, or food in the cavity when not in use.

Do not operate oven when room humidity is excessive.

## Child Safety

Do not allow children to use this appliance. Failure to do so can result in burns or serious injury to children. Children and pets should not be left alone or unattended in the area where the appliance is in use. They should never be allowed to play in its vicinity, whether or not the appliance is in use.

Do not allow anyone to climb, stand, lean, sit, or hang on any part of an appliance, especially a door, warming drawer, or storage drawer. This can damage the appliance, and the unit may tip over, potentially causing severe injury.

## Cleaning Safety

---

### WARNING

Be sure the entire appliance has cooled and grease has solidified before attempting to clean any part of the appliance.

---

## Utilisation prévue

Cet appareil est destiné uniquement à une utilisation domestique normale. Il n'est pas homologué pour un usage en extérieur. Voyez la garantie. Si vous avez des questions, communiquez avec le fabricant.

N'utilisez pas la cavité aux fins de rangement. Ne laissez pas des produits de papier, des ustensiles de cuisson ou des aliments dans la cavité lorsque celle-ci ne sert pas.

N'utilisez pas le four lorsque l'humidité de la pièce est excessive.

## Sécurité des enfants

Ne pas permettre aux enfants d'utiliser cet appareil sauf sous la surveillance attentive d'un adulte. Ne pas laisser les enfants et les animaux seuls ou sans surveillance lorsque l'appareil, que ce dernier soit en service ou non.

Ne permettre à personne de grimper, rester debout, s'appuyer, s'asseoir ou se pencher sur toute partie d'un appareil, notamment une porte, un tiroir-réchaud ou un tiroir de rangement. Ceci peut endommager l'appareil qui risque de basculer et causer des blessures sérieuses.

## Consignes en matière de nettoyage

---

### AVERTISSEMENT

Assurez-vous que l'appareil tout entier s'est refroidi et que la graisse s'est solidifiée avant de tenter de nettoyer une partie quelconque de l'appareil.

---



# IMPORTANT SAFETY INSTRUCTIONS

READ ALL INSTRUCTIONS BEFORE USING THE APPLIANCE



# CONSIGNES DE SÉCURITÉ IMPORTANTES

LISEZ TOUTES LES INSTRUCTIONS AVANT D'UTILISER L'APPAREIL

## Cooking Safety

---

### CAUTION

---

To avoid personal injury or property damage, observe the following:

- Do not leave oven unattended while in use.
- Do not store flammable material next to or in the oven.
- When flaming foods under the microwave, always turn the fan on.
- Do not operate the oven while empty. This could damage the oven and result in a risk of fire.
- Do not store or use corrosive chemicals, vapors, flammables or nonfood products in or near this appliance. It is specifically designed for use when heating or cooking food. The use of corrosive chemicals in heating or cleaning will damage the appliance and could result in injury.
- Do not dry clothes, newspapers or other materials in the oven. Do not use newspapers or paper bags for cooking. Fire could result.
- Do not use recycled paper products unless labeled safe for microwave use. They may contain impurities which may cause sparks and result in fires when used.
- Always use potholders when removing items from the oven. The cooking container and the glass tray can be hot even if the oven is cool.
- Do not mount over sink.
- Do not store anything directly on top of the appliance surface when the appliance is in operation.
- Oversized food or oversized metal utensils should not be inserted in a microwave oven as they may create a fire or risk of electric shock.

## Sécurité de cuisson

---

### ATTENTION

---

Pour éviter les blessures corporelles ou les dégâts matériels, veuillez suivre les consignes suivantes :

- Ne laissez pas le four sans surveillance pendant qu'il est en marche.
- N'entreposez pas de matières inflammables près ou dans le four.
- Lorsque vous flambez des aliments sous le micro-ondes, allumez toujours le ventilateur.
- Ne faites pas fonctionner le four à vide. Cela pourrait endommager le four et entraîner un risque d'incendie.
- N'entreposez pas et n'utilisez pas des produits chimiques corrosifs, des vapeurs, des matériaux inflammables ou des produits non alimentaires près ou dans cet appareil. Cet appareil est spécialement conçu pour chauffer ou cuire la nourriture. L'emploi de produits chimiques corrosifs dans la cuisson ou le nettoyage endommagera l'appareil et pourrait causer des blessures.
- Ne séchez pas les vêtements, les journaux ou autres matériaux dans le four. N'utilisez pas des journaux ou des sacs de papier pour la cuisson. Il pourrait en résulter un incendie.
- N'utilisez pas des produits fabriqués de papier recyclé à moins que leur sécurité au micro-ondes soit attestée. Ils pourraient contenir des impuretés pouvant causer des étincelles et provoquer un incendie.
- Utilisez des poignées pour retirer les éléments du four. Le récipient de cuisson et le plateau de verre peuvent être chauds même si le four est froid.
- Ne montez pas l'appareil au-dessus d'un évier.
- Ne rangez aucun objet directement sur le dessus de l'appareil lorsque l'appareil est en cours de fonctionnement.
- La nourriture ou les ustensiles métalliques surdimensionnés ne devraient pas être placés dans le micro-ondes, car ils pourraient entraîner des risques de décharge électrique ou d'incendie.

# ⚠ IMPORTANT SAFETY INSTRUCTIONS

READ ALL INSTRUCTIONS BEFORE USING THE APPLIANCE

# ⚠ CONSIGNES DE SÉCURITÉ IMPORTANTES

LISEZ TOUTES LES INSTRUCTIONS AVANT D'UTILISER L'APPAREIL

- Do not clean with metal scouring pads. Pieces can burn off the pad and touch electrical parts involving a risk of electric shock.
- Do not store any materials, other than manufacturer's recommended accessories, in this oven when not in use.
- Do not cover racks or any other part of the oven with metal foil. This will cause overheating of the oven.

- Ne nettoyez pas le four avec des éponges à récurer métalliques. Des morceaux peuvent brûler et se détacher des éponges et entrer en contact avec des composants électriques, ce qui pourrait entraîner un risque de décharge électrique.
- N'entreposez pas de matériaux dans ce four, autres que les accessoires recommandés par le fabricant, lorsqu'il n'est pas utilisé.
- Ne recouvrez pas les grilles ou toute autre partie du four de feuilles métalliques. Cela causerait une surchauffe du four.

## In Case of Fire

If materials inside an oven should ignite:

- 1 Keep door closed
- 2 Turn appliance off
- 3 Isolate the power by shutting off at fuse or circuit breaker

## Liquids

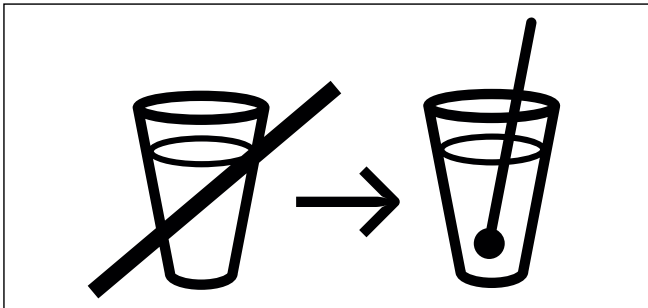

Liquids, such as water, coffee, or tea are able to be overheated beyond the boiling point without appearing to be boiling. Visible bubbling or boiling when the container is removed from the microwave oven is not always present. **THIS COULD RESULT IN VERY HOT LIQUIDS SUDDENLY BOILING OVER WHEN THE CONTAINER IS DISTURBED OR A UTENSIL IS INSERTED INTO THE LIQUID.**

When heating liquids, always place a glass rod/spoon in the container. This will prevent delayed boiling.

## En cas d'incendie

Si jamais des matériaux à l'intérieur du four venaient à prendre feu :

- 1 Gardez la porte fermée
- 2 Éteignez l'appareil
- 3 Isolez l'alimentation en la coupant au fusible ou au disjoncteur

## Liquides

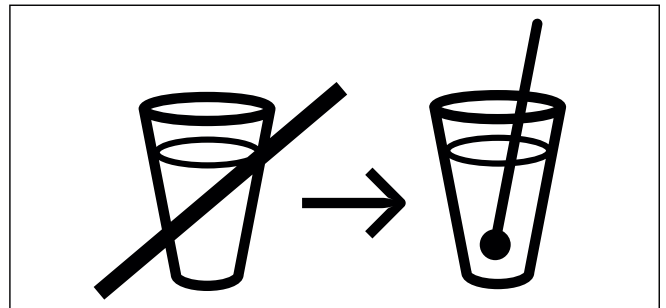

Des liquides, comme de l'eau, du café ou du thé peuvent surchauffer. Ils peuvent être chauffés au-delà du point d'ébullition sans que cela ne paraisse. Par exemple, le bouillonnement ou l'ébullition lorsque le contenant est retiré du micro-ondes n'est pas toujours présent. **CELA POURRAIT RÉSULTER DANS DES LIQUIDES TRÈS CHAUDS QUI BOUILLONNERONT SOUDAINEMENT DÈS LORS QUE LE CONTENANT EST DÉRANGÉ OU QU'UN USTENSILE EST INSÉRÉ DANS LE LIQUIDE.**

Lorsque vous faites chauffer des liquides, placez toujours une baguette en verre ou une cuillère dans le contenant. Vous pourrez ainsi éviter un retard d'ébullition.



# IMPORTANT SAFETY INSTRUCTIONS

READ ALL INSTRUCTIONS BEFORE USING THE APPLIANCE



# CONSIGNES DE SÉCURITÉ IMPORTANTES

LISEZ TOUTES LES INSTRUCTIONS AVANT D'UTILISER L'APPAREIL

---

## CAUTION

---

Metal e.g. a spoon in a glass must be kept at least 1 in (25 mm) from the oven walls and the inside of the door. Sparks could irreparably damage the glass on the inside of the door.

---

- Take ready meals out of the packaging. They will heat up more quickly and evenly in microwaveable ovenware. The different components of the meal may not require the same amount of time to heat up.
- Always cover the food. If you do not have a suitable cover for your container, use a plate or special microwave foil.
- Stir or turn the food several times during cooking. Check the temperature.
- After heating, allow the food to stand for a further 2 to 5 minutes so that it can achieve an even temperature.
- Always use an oven cloth or oven gloves when removing plates from the oven.

## Cooking Items

**Eggs:** Do not cook or reheat whole eggs, with or without shell. Steam buildup in whole eggs may cause them to explode, and possibly damage the oven or cause injury. Reheating sliced hard-boiled eggs and cooking scrambled eggs is safe.

**Popcorn:** Use only popcorn in packages designed and labeled for microwave use, or pop it in a microwave oven corn popper. Follow popcorn manufacturers' directions and use a brand suitable for the wattage of your oven. Do not continue to heat after popping has stopped. Popcorn will scorch or burn. Do not leave oven unattended.

---

## ATTENTION

---

Du métal, par exemple, une cuillère dans un verre, doit être conservé à au moins 1 pouce (25 mm) des parois du four et de l'intérieur de la porte. Des étincelles pourraient endommager irrévocablement le verre à l'intérieur de la porte.

---

- Retirez les plats préparés de leur emballage. Ils chaufferont plus rapidement et plus uniformément dans des plats allant au micro-ondes. Les différents composants du repas pourraient nécessiter des temps de cuisson différents.
- Couvrez toujours la nourriture. Si vous ne possédez pas un couvercle adéquat pour votre contenant, utilisez une assiette ou un papier spécial conçu pour le micro-ondes.
- Brassez ou retournez la nourriture plusieurs fois au cours de la cuisson. Vérifiez la température.
- Après la cuisson, laissez la nourriture reposer de 2 à 5 minutes supplémentaires pour obtenir une température uniforme.
- Utilisez toujours un linge ou des gants pour le four lorsque vous retirez des assiettes du four.

## Articles de cuisson

**Oeufs:** Ne faites pas cuire ou réchauffer des œufs entiers, avec ou sans coquille. La vapeur s'accumule dans les œufs, ce qui peut les amener à éclater, et endommager potentiellement le four ou causer des blessures. Le réchauffement d'œufs durs en tranches ou la cuisson d'œufs brouillés ne pose aucun problème.

**Popcorn:** Utilisez uniquement du popcorn dans des emballages conçus et étiquetés pour usage dans le micro-ondes, ou faites-le éclater dans un éclateur de popcorn pour four à micro-ondes. Suivez les instructions du fabricant du popcorn et utilisez une marque qui convient à l'intensité électrique de votre four. Ne continuez pas de cuire après que le popcorn a cessé d'éclater. Le popcorn risquerait alors de brûler. Ne laissez pas le four sans surveillance.



# IMPORTANT SAFETY INSTRUCTIONS

READ ALL INSTRUCTIONS BEFORE USING THE APPLIANCE



# CONSIGNES DE SÉCURITÉ IMPORTANTES

LISEZ TOUTES LES INSTRUCTIONS AVANT D'UTILISER L'APPAREIL

---

## CAUTION

When using pre-packaged microwave popcorn, check package weight before using the popcorn function. Set the oven for the weight of the popcorn package. If these instructions are not followed, popcorn may not pop adequately or may ignite and cause fire.

**Foods with nonporous skins:** Potatoes, tomatoes, sweet potatoes, apples, whole squash and sausages are examples of foods with nonporous skins. These types of foods must be pierced before cooking to prevent them from exploding.

**Baby food / Baby formula:** Do not heat baby bottles or food in microwave oven. The glass jar or the surface of food may appear warm while the interior can burn the infant's mouth and esophagus.

**Deep fat frying:** Do not deep fat fry in oven. Oil can be heated beyond ideal temperatures very quickly in a microwave oven. Temperatures can climb high enough for the cooking oils to reach their respective flash points and burst into flames. The heated oil may bubble and spatter causing possible damage to the oven and perhaps result in burns. Additionally, microwave-safe utensils may not be able to withstand the temperature of the hot oil, and could result in the utensil shattering, if it contains a slight imperfection, scratch or chip.

---

## ATTENTION

Lorsque vous utilisez du popcorn préemballé pour micro-ondes, vérifiez le poids de l'emballage avant d'utiliser la fonction de popcorn. Réglez le four selon le poids de l'emballage du popcorn. Si vous ne suivez pas ces instructions, il se peut que le popcorn ne s'éclate pas correctement et pourrait s'enflammer et causer un incendie.

**Aliments avec peau non poreuse :** Les pommes de terre, les tomates, les patates douces, les pommes, les courges entières et les saucissons sont des exemples d'aliments avec des peaux non poreuses. Ces types d'aliments doivent être percés avant la cuisson pour les empêcher d'éclater.

**Aliments pour nourrissons / lait maternisé:** Ne chauffez pas les biberons ou les aliments pour nourrissons dans le four à micro-ondes. Le pot de verre ou la surface de l'aliment pourrait sembler tiède alors que l'intérieur pourrait brûler la bouche et l'œsophage du nourrisson.

**Grande friture de gras :** N'effectuez pas de grande friture de gras dans le four. L'huile pourrait chauffée très rapidement au-delà de sa température idéale dans un four à micro-ondes. Les températures pourraient monter à tel point que l'huile de cuisson arrivera au point d'inflammabilité et s'enflammera. L'huile chauffée pourrait bouillonner et être projetée causant des dommages potentiels au four et même des blessures aux personnes. Par ailleurs, les ustensiles micro-ondables pourraient ne pas supporter la température de l'huile chaude et pourraient occasionner le bris de l'ustensile si celui-ci contient une imperfection, une rayure ou une écaille.



## IMPORTANT SAFETY INSTRUCTIONS

READ ALL INSTRUCTIONS BEFORE USING THE APPLIANCE



## CONSIGNES DE SÉCURITÉ IMPORTANTES

LISEZ TOUTES LES INSTRUCTIONS AVANT D'UTILISER L'APPAREIL

**Home Canning / Drying foods / Small quantities of foods:** Do not use microwave oven for home canning or heating of any closed jar. Pressure will build up and the jar may explode. In addition, the oven cannot maintain the food at the proper canning temperature. Improperly canned food may spoil and be dangerous to consume. Small quantities of food or foods with low moisture content can dry out, burn or catch on fire. Do not dry meats, herbs, fruits or vegetables in your oven.

Proper cooking depends on time set and weight of food. If you use a smaller portion than recommended and cook at the time for the recommended portion, fire could result.

**Browning dishes:** Microwave browning dishes or grills are designed for microwave cooking only. Preheating times vary depending on the size of the browning dish and food being cooked. Always follow instructions provided by the browning dish or grill manufacturer. Do not preheat browning dishes more than 6 minutes.

**Oven roasting bags:** If an oven bag is used for microwave cooking, prepare according to package directions. Do not use wire twist-ties to close bags, instead use nylon ties, cotton string or a strip cut from the open end of the bag. Make six ½" (12.7 mm) slits by closure. Place oven cooking bag in a dish slightly larger than the food being cooked.

**Conserves maison / Séchage des aliments / Petites quantités d'aliments :** N'utilisez pas le four à micro-ondes pour les conserves maison ou pour le chauffage de tout pot fermé. La pression s'accumulera et le pot pourrait éclater. Par ailleurs, le four ne peut maintenir l'aliment à la bonne température de mise en conserve. Les aliments mis en conserve incorrectement pourraient rancir et être dangereux à consommer. De petites quantités d'aliments ou des aliments à faible contenu d'humidité peuvent s'assécher, brûler ou s'enflammer. Ne séchez pas les viandes, herbes, fruits ou légumes dans votre four.

La cuisson appropriée dépend du temps réglé et du poids de l'aliment. Si vous utilisez une portion plus petite que celle recommandée et faites cuire la portion au temps recommandé, un incendie pourrait en résulter.

**Plats de brunissement :** Les plats de brunissement ou les grilles du micro-ondes sont conçus uniquement pour la cuisson au micro-ondes. Les temps de préchauffage varient selon la taille du plat de brunissement et de l'aliment à cuire. Suivez toujours les instructions fournies par le fabricant du plat de brunissement ou de la grille. Ne préchauffez pas les plats de brunissement pendant plus de 6 minutes.

**Sacs de rôtisserie de four :** Si un sac de four est utilisé pour la cuisson au micro-ondes, préparez selon les directions de l'emballage. N'utilisez pas des attaches pour fermer les sacs, utilisez à la place des attaches de nylon, du fil en coton ou d'une bande coupée de l'extrémité ouverte du sac. Pratiquez 6 fentes de ½ po (12,4 mm) après la fermeture du sac. Placez le sac de cuisson dans un plat légèrement plus grand que l'aliment à cuire.



# IMPORTANT SAFETY INSTRUCTIONS

READ ALL INSTRUCTIONS BEFORE USING THE APPLIANCE



# CONSIGNES DE SÉCURITÉ IMPORTANTES

LISEZ TOUTES LES INSTRUCTIONS AVANT D'UTILISER L'APPAREIL

## Cooking Utensils

Cooking utensils, the glass tray and racks get hot during microwaving. Always use potholders when removing items from the oven. Allow the glass tray and the metal racks (if used) to cool before handling.

Do not use metal utensils, or dishes with metallic trim in the oven.

When using aluminum foil in the oven, allow at least 1" (25.4 mm) of space between foil and interior oven walls or door.

The glass tray and the metal racks (if used) will get hot during cooking. The cooking container and the glass tray can be hot even if the oven is cool.

Never use paper, plastic, or other combustible materials that are not intended for cooking.

When cooking with paper, plastic, or other combustible materials, follow manufacturer's recommendations on product use. Do not use paper towels which contain nylon or synthetic fibers. Heated synthetics could melt and cause paper to ignite

Do not heat sealed containers or plastic bags in oven. Food or liquid could expand quickly and cause container or bag to break. Pierce or open container or bag before cooking.

## Thermometers

Do not use regular cooking thermometers in oven. Most cooking thermometers contain mercury and may cause electrical arc, malfunction, or damage to the oven.

## Pacemakers

---

### CAUTION

To avoid pacemaker malfunction, consult physician or pacemaker manufacturer about effects of microwave energy on pacemaker.

---

## Utensiles de cuisson

Les ustensiles de cuisson, les plateaux de verre et les grilles deviennent chauds pendant la cuisson au micro-ondes. Utilisez des supports de casserole lorsque vous retirez les éléments du four. Laissez le plateau de verre et les grilles métalliques se refroidir (le cas échéant) avant de les manipuler.

N'utilisez pas des ustensiles métalliques ou des plats contenant une garniture métallique dans le four.

Lorsque vous utilisez de la feuille en aluminium dans le four, prévoyez au moins un espace de un pouce (25,4 mm) entre la feuille et les parois intérieures du four ou la porte.

Le plateau de verre et les grilles métalliques (le cas échéant) deviendront chauds pendant la cuisson. Le récipient de cuisson et le plateau de verre peuvent être chauds même si le four est froid.

N'utilisez jamais des matériaux en papier, plastique ou autres matériaux combustibles non prévus pour la cuisson.

Lorsque vous faites cuire avec des matériaux de papier, de plastique ou autres matériaux combustibles, suivez les recommandations du fabricant. N'utilisez pas des serviettes de papier qui contiennent des fibres de nylon ou des fibres synthétiques. Le chauffage de fibres synthétiques pourrait fondre et amener le papier à s'enflammer.

Ne pas chauffer des contenants scellés ou des sacs de plastique dans le four. L'aliment ou le liquide pourrait se dilater rapidement et causer le bris du contenant ou du sac. Percez ou ouvrez le contenant ou le sac avant la cuisson.

## Thermomètres

N'utilisez pas des thermomètres de cuisson ordinaires dans le four. La plupart des thermomètres de cuisson contiennent du mercure et pourraient causer un arc électrique, une anomalie ou des dommages au four.

## Pacemakers

---

### ATTENTION

Pour éviter la défaillance d'un stimulateur cardiaque, consultez le médecin ou le fabricant du stimulateur cardiaque à propos des effets de l'énergie micro-ondes sur le stimulateur cardiaque.

---



# **IMPORTANT SAFETY INSTRUCTIONS**

READ ALL INSTRUCTIONS BEFORE USING THE APPLIANCE

# **CONSIGNES DE SÉCURITÉ IMPORTANTES**

LISEZ TOUTES LES INSTRUCTIONS AVANT D'UTILISER L'APPAREIL

## Fan Motor Operation

After using the oven the fan motor can rotate to cool the electric components. This is perfectly normal, and you can take out the food from the oven while the fan operates.

### Proposition 65 Warning:

This product may contain a chemical known to the State of California, which can cause cancer or reproductive harm. Therefore, the packaging of your product may bear the following label as required by California:

**STATE OF CALIFORNIA PROPOSITION 65 WARNING:**



Cancer and Reproductive Harm - [www.P65Warnings.ca.gov](http://www.P65Warnings.ca.gov)

### WARNING

While cooking food items, small amounts of certain by-products, such as particulate matter / soot, can be released. To minimize exposure to these substances:

- ▶ Always ensure proper ventilation by using an appropriate ventilation fan or hood vented to the outside and/or an open window.
- ▶ Always operate the unit according to the instructions in this manual.

### WARNING

Overheated materials can cause fire or burns and may produce potentially harmful smoke or fumes.

- ▶ To prevent overheating, turn ventilation hood ON when heating grease, fats or frying using medium to high heat settings.
- ▶ Avoid heating empty pots and pans.
- ▶ Do not allow pans to boil dry.
- ▶ Do not allow aluminum foil, plastic, paper, or cloth to come in contact with a hot surface element, burner, or grate.

## Fonctionnement du moteur du ventilateur

Après l'utilisation du four, le moteur du ventilateur continue de tourner afin de refroidir les composants électriques. Cela est parfaitement normal et il est possible de retirer la nourriture du four pendant que le ventilateur est en marche.

### Avertissement issu de la proposition 65 :

Ce produit pourrait contenir un produit chimique reconnu par l'État de la Californie comme cancérigène ou ayant des effets nocifs sur la reproduction. Par conséquent, l'emballage de votre produit pourrait porter l'étiquette suivante, comme requis par la Californie :

**AVERTISSEMENT ISSU DE LA PROPOSITION 65 DE L'ÉTAT DE LA CALIFORNIE :**



Cancer et dommages à la reproduction - [www.P65Warnings.ca.gov](http://www.P65Warnings.ca.gov)

### AVERTISSEMENT

Lors de la cuisson des aliments, de petites quantités de certains sous-produits, tels que des particules / de la suie, peuvent être libérés. Pour minimiser l'exposition à ces substances:

- ▶ Assurez-vous d'avoir toujours une ventilation adéquate en utilisant un ventilateur approprié ou une hotte avec une évacuation vers l'extérieur et/ou une fenêtre ouverte.
- ▶ Faites toujours fonctionner l'appareil en suivant les consignes de ce manuel.

### AVERTISSEMENT

Les matériaux surchauffés peuvent provoquer un incendie ou des brûlures et peuvent produire des émanations ou fumées potentiellement dangereuses.

- ▶ Pour éviter une surchauffe, allumez la hotte lorsque vous chauffez des graisses ou faites frire quelque chose en utilisant des paramètres de température moyen à haut.
- ▶ Évitez de chauffer des casseroles et des poêles vides.
- ▶ Ne laissez pas les casseroles bouillir à sec.
- ▶ Ne laissez pas du papier d'aluminium, du plastique, du papier ou du tissu entrer en contact avec un élément chaud, un brûleur ou une grille.

**SAVE THESE INSTRUCTIONS.**

**CONSERVEZ CES INSTRUCTIONS.**



---

## Causes of damage

---

- Metal - e.g. a spoon in a glass - must be kept at least 1" (25 mm) from the oven walls and the inside of the door. Sparks could irreparably damage the glass on the inside of the door.
- Water in the hot oven interior: Never pour water into the hot oven interior. Steam is produced. Damage to the enamel can arise due to the temperature change.
- Do not leave moist groceries in a closed oven for an extended period of time. It can lead to corrosion inside the oven.
- Fruit juice can leave stains in the oven. Always remove fruit juice immediately when safe to touch, and wipe up first with a damp and then a dry cloth.
- Cooling with the appliance door open: only allow the oven cavity to cool when it is closed. Even if the appliance door is only open a little, front panels of adjacent units could be damaged over time.
- Highly soiled door seal: the appliance door will no longer close properly during operation if the door seal is highly soiled. Adjoining furniture fronts may be damaged. Always keep the door seal clean.
- Appliance door as a seat or storage surface: do not stand, sit or hang on the appliance door. Do not place any cookware or accessories on the appliance door.
- Inserting accessories: depending on the appliance type, accessories can scratch the door pane when closing the appliance door. Always slide accessories fully into the oven interior.
- Do not hold or carry the appliance by the door handle. The door handle cannot carry the weight of the device and could break off, or the hinges can be damaged.
- Operating the microwave without food in the oven cavity may lead to overloading. Never run the microwave unless there is food in the oven cavity. An exception to this rule is a short ovenware test.  
→ *"Notes regarding cookware" on page 24*
- Always set the microwave power as recommended for the food. High power settings can overheat foods very quickly.

---

## Protecting the environment

---

Unpack the appliance and dispose of the packaging in an environmentally friendly manner.

### Tips for saving energy

- Only preheat the oven if this is specified in the recipe or in the operating instruction tables.
- Use dark, black lacquered or enameled baking tins for baking. They absorb the heat particularly well.
- It is best to bake more than one cake, one after the other. The oven is still warm. This reduces the baking time for the second cake.
- For longer cooking times, you can switch the oven off 10 minutes before the end of the cooking time and use the residual heat to finish cooking.

## Getting to know the appliance

You will get to know your new appliance here. We explain the control panel and the individual controls to you. You are informed about the oven interior and accessories.

## Displays and controls

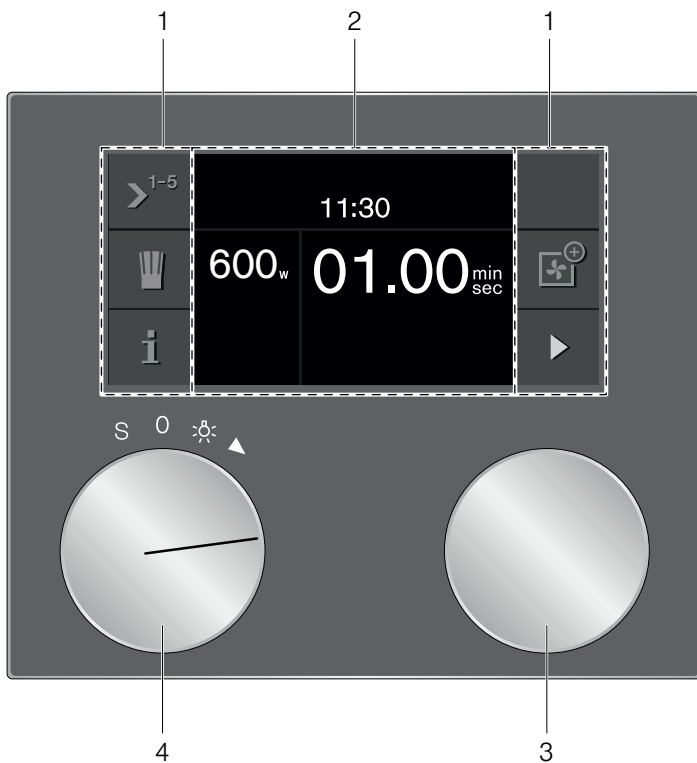

1	Control panel	These areas are touch-sensitive. Touch a symbol to select the applicable function.
2	Display	The display shows current settings and options, for example.
3	Rotary selector	You can change the settings with the rotary selector or the function selector.
4	Function selector	Select the required microwave output, type of oven heating, basic settings or the light using the function selector.



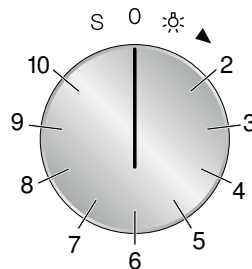









## Function selector positions



Position	Function
0	Off position
☼	Light
2	1000 W microwave
3	600 W microwave
4	360 W microwave
5	180 W microwave
6	90 W microwave
7	☼ Convection
8	☼ Convection broil
9	☼ Broil + circulated air
10	☼ Broil
S	Basic settings

## Symbols

Symbol	Function
▶	Start
■	Stop
	Pause/end
X	Cancel
C	Delete
✓	Confirm/save settings
>	Selection arrow
i	Launching additional information
☰	Calling up additional tips
☼	Calling up automatic programs, personal recipes
↙	Save
↘	Edit settings
🔒	Child lock
🕒	Launching the timer menu
🕒	Launching the Sabbath mode
> <sup>1-5</sup>	Series of operations
rec	Recording a menu
>A <sup>4</sup>	Enter a name
☒	Delete letters
0 <sub>w</sub>	Microwave, letting dish rest
✂	Demo mode
⌋	Preheating with status display

	Quick heating with status indicator
	Timer
	Stop watch
	Automatic programs:
	Weight
	Cooking result
	Defrosting
	Cooking, combi cooking
	Combination mode:
	Calling up oven
	Removing oven
	Adding oven
	Calling up microwave
	Removing microwave
	Adding microwave

## Colors and display

### Colors

The various colors serve as user guidance in each setting situation.

orange	Initial settings
	Main functions
blue	Basic settings
white	Adjustable values

### Presentation

Depending on the situation, the display of symbols, values, and indicators changes.

Zoom	Values and symbols that are currently selected will be displayed enlarged.
Minimized screen display	After a short while, the display screen will be reduced and only the essential displayed. This function is pre-set and can be changed in the basic settings.

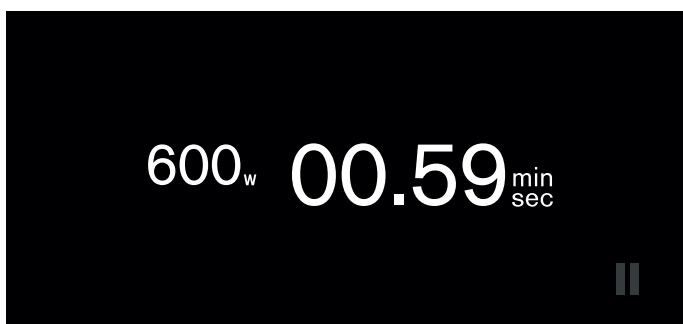

## Additional information **i**

By touching the **i** symbol, you can call up additional information.

Before starting, you receive information about the set heating function, for example. This allows you to check whether the current setting is suitable for your meal.

During operation, you receive information about the elapsed and remaining time and/or the current oven interior temperature, for instance.

**Note:** Slight temperature fluctuations are normal during continuous operation after heating up.

## Cooling fan

Your appliance has a cooling fan. The cooling fan switches on during operation. The hot air escapes above the door.

The cooling fan continues to run for a certain time after the operation.

### CAUTION

Do not cover the ventilation slots. Otherwise, the appliance may overheat.

### ATTENTION

Ne pas couvrir les fentes d'aération. Sinon l'appareil surchauffe.

### Notes

- The appliance remains cool during microwave operation. Despite this, the cooling fan will still switch on. The fan may run on even when the microwave operation has ended.
- Condensation may form on the door window, interior walls and floor. This is normal and does not adversely affect microwave operation. Wipe away the condensation after cooking.

## Accessories

The accessories can be inserted into the appliance at 4 different heights.

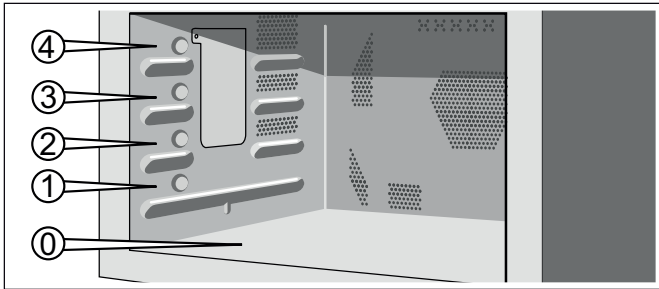

**Note:** Microwavable cookware can be placed on the oven floor (level 0).

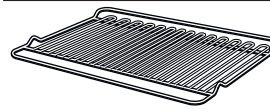

### Wire rack

For cookware, cake tins, roasts, grilled items and frozen meals.

**Note:** You can pull the wire rack two thirds of the way out without it tipping. This allows meals to be removed more easily.

---

### CAUTION

- Do not use the rack to pop popcorn.
  - Do not cook with the rack on the floor of the microwave oven.
  - For regular microwave cooking use the glass tray and remove the rack.
  - The rack can get hot during cooking. Allow the rack to cool down before handling.
- 

---

### ATTENTION

- N'utilisez pas la grille pour faire éclater le popcorn.
  - Ne cuisez pas avec la grille sur le plancher du four à micro-ondes.
  - Pour une cuisson au micro-ondes normale, utilisez la lèchefrite en verre et retirez la grille.
  - La grille peut devenir très chaude pendant la cuisson. Laissez la grille se refroidir avant de la manipuler.
- 

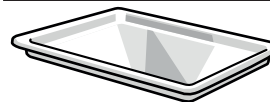

### Glass tray

For large roasts, moist cakes, casseroles and gratins. This can act as a splash guard if you are grilling meat directly on the wire rack. For this, insert the glass tray on level 1.

The glass tray can also be used as a standing surface during microwave operation.

---

### Glass rod

For heating liquids in narrow containers. It prevents delayed boiling. When heating liquids, always place a glass rod/spoon in the container.

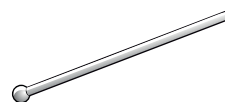

---

## Before first use

---

Here you will find everything you need to do before using the microwave to prepare food for the first time. Read the Safety information section beforehand.

→ *"IMPORTANT SAFETY INSTRUCTIONS"*  
on page 5

The appliance must be completely fitted and connected.

The "First settings" menu appears in the display after the mains has been connected. You can now set your new appliance:

- Language
- Time format
- Time
- Date format
- Date
- Temperature format

### Notes

- The "Initial settings" menu only appears when you first connect the power or if the appliance has been without power for several days.

After connecting the power, first the GAGGENAU logo appears for approx. 30 seconds, then the "Initial settings" menu appears automatically.

- You can change these settings at any time. → *"Basic Settings"* on page 39

## Setting the language

The default language appears in the display.

1. Select the desired display language with the rotary selector.
2. Confirm with ✓.



**Note:** When the language is changed, the system is restarted; this procedure takes a few seconds.

## Setting the time format

the two possible formats 24h and AM/PM appear in the display. The default format is 24h.

1. Set the required format with the rotary selector.
2. Confirm with ✓.



## Setting the time

The time appears in the display.

1. Set the required time with the rotary selector.
2. Confirm with ✓.



## Setting the date format

The three possible formats D.M.Y, D/M/Y and M/D/Y appear in the display. The D.M.Y is the default.

1. Set the required format with the rotary selector.
2. Confirm with ✓.

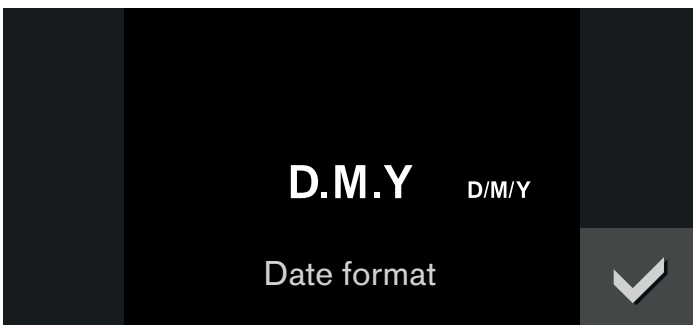

## Setting the date

The default date appears in the display. The day setting is already active.

1. Set the required day with the rotary selector.
2. Switch to the month setting with the > symbol.
3. Set the month with the rotary selector.
4. Switch to the year setting with the > symbol.
5. Set the year with the rotary selector.
6. Confirm with ✓.

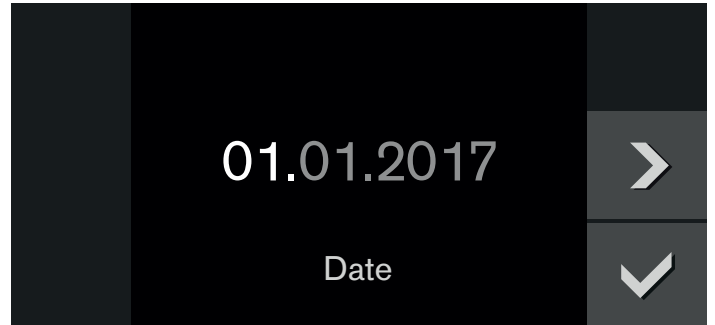

## Setting the temperature format

The two possible formats °C and °F appear in the display. The °C format is selected by default.

1. Set the required format with the rotary selector.
2. Confirm with ✓.

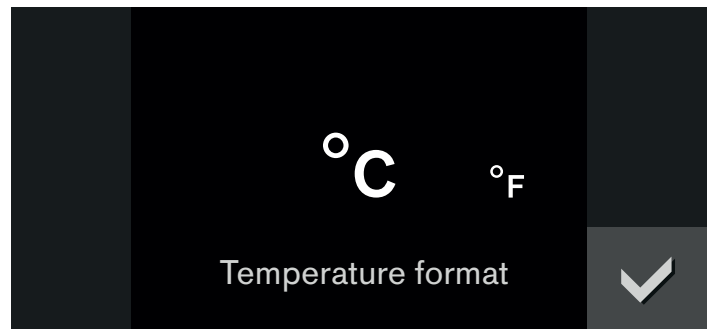

## Completing initial set-up

"Initial set-up complete" appears in the display.

Confirm with ✓.

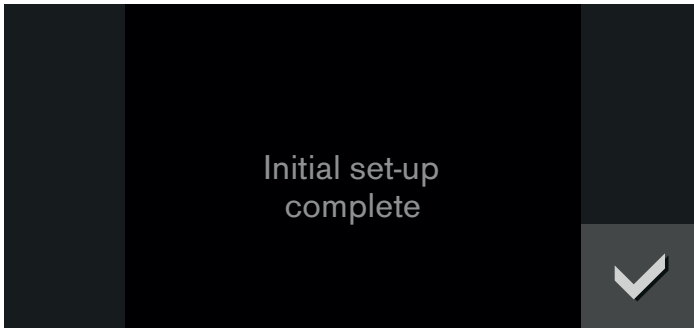

The appliance enters the standby mode and the standby display appears. The appliance is now ready for operation.

## Heating up the oven

Ensure that no packaging remnants have been left in the cooking compartment.

To remove the new cooker smell, heat up the oven when it is empty and closed. An hour with Convection Broil  at 390°F (200°C) is ideal for this purpose. For instructions on how to set this type of heating, refer to the section.

## Cleaning accessories

Before using accessories for the first time, thoroughly clean them with hot soapy water and a soft dish cloth.

---

## Activating the appliance

---

### Standby

The appliance is in standby mode if no function is set or the child lock is activated.

The brightness of the control panel is dimmed in standby mode.

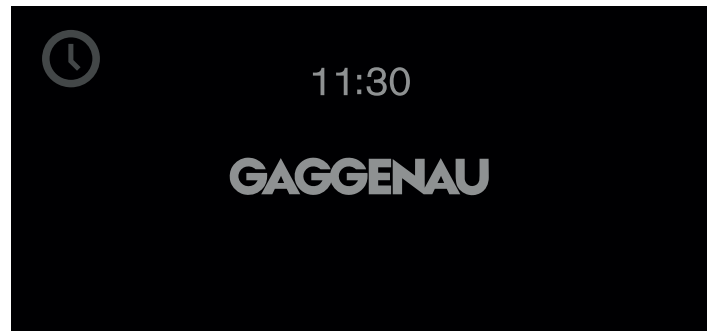

### Notes

- There are various indicators for standby mode. Pre-set is the GAGGENAU logo and the time. If you would like to change the display, see the section on [Display](#).
- The brightness of the display depends on the vertical viewing angle. You can even out the display using the "Brightness" setting in the basic settings.

### Activate appliance

In order to exit standby mode, you can either

- Set the function selector,
- Touch a control panel,
- or open or close the door.

Now you can set the desired function. Read the appropriate chapters to learn how to set functions.

### Notes

- If "Standby screen = off" is selected in the basic setting, you must turn the function selector to exit the standby mode.
- The standby display appears again if you have not made any settings for a long while after activation.
- The cooking compartment lighting goes out after a little while if the door is open.

## Microwave

Microwaves are converted to heat in food. The microwave can be used solo, i.e. on its own, or in combination with a different type of heating.

**Note:** In the section "Tables and Tips", you will find examples for defrosting, heating, and cooking with the microwave. → "Tables and tips" on page 47

### Notes regarding cookware

Heat-resistant cookware made of glass, glass ceramic, porcelain, ceramic or heat-resistant plastic is suitable. These materials allow microwaves to pass through. You can also use serving dishes. This saves you having to transfer food from one dish to another. You should only use cookware with decorative gold or silver trim if the manufacturer guarantees that it is suitable for use in microwaves.

Metal cookware is unsuitable. Metal does not allow microwaves to pass through. Food in covered metal containers will remain cold.

#### CAUTION

Metal e.g. a spoon in a glass must be kept at least 1 in (25 mm) from the oven walls and the inside of the door. Sparks could irreparably damage the glass on the inside of the door.

#### ATTENTION

Du métal, par exemple, une cuillère dans un verre, doit être conservé à au moins 1 pouce (25 mm) des parois du four et de l'intérieur de la porte. Des étincelles pourraient endommager irrévocablement le verre à l'intérieur de la porte.

**Cookware test:** Do not switch on the microwave unless there is food inside. The following cookware test is the only exception to this rule. If you are unsure whether your cookware is microwave compatible, perform this test: place the empty dish in the appliance for 1/2 for 1 minute at maximum power. Check the temperature during that time. The cookware should be cold or warm to the touch. The cookware is unsuitable if it becomes hot or sparks are generated.

## Microwave output

You can make the following new settings:

90 W	For defrosting delicate foods
180 W	For defrosting and continued cooking
360 W	For cooking meat and for heating delicate foods
600 W	For heating and cooking food
1000 W	For heating liquids

**Note:** The microwave power can be set to 1000 watts for a maximum of 30 minutes. A cooking time of 90 minutes is possible with all other power settings.

## Setting the microwave

1. Set the required microwave output setting using the function selector.
2. Set the cooking time using the rotary selector.
3. Start with ▶.

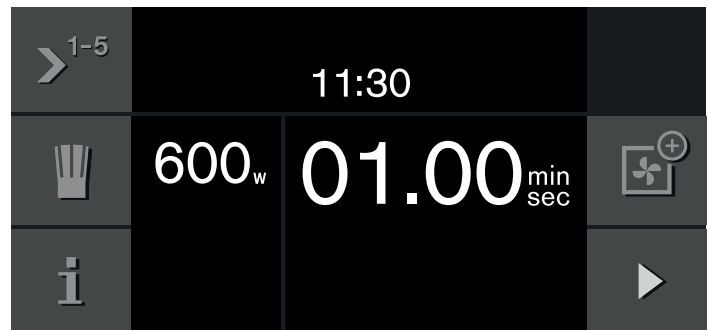

The operation begins. The cooking time starts counting down.

An audible signal sounds once the cooking time has elapsed. The signal stops early if you touch the ✓ symbol, open the appliance door, or set the function selector to 0. The microwave operation has finished.

If you open the oven door during operation, the microwave operation is paused. After closing the door, touch the ▶ symbol. The operation continues.

You can change the cooking time at any time using the rotary selector.

You can change the output at any time using the function selector. Press ▶ to restart.

You can call up the elapsed cooking time using the i symbol. Touch the ✓ symbol to return to the standard display.

#### **Pause:**

The operation can be paused using the || symbol. Use the ▶ symbol to continue.



**Switching off:**

To stop the operation and cancel the settings, turn the function selector to **0**.

**Note:** It is normal for the fan to continue operating even when the door is open.

---

## Oven

---

In oven mode, you can set the following types of heating:

Type of heating	Temperature °F (°C)	Usage
✦ Convection	100 (40)	Let yeast dough rise, defrost cream cakes
	210 - 480 (100-250)	Bake cakes, small baked goods, and pizza on the glass tray
✦ Convection broil	210 - 480 (100-250)	Roasting large pieces of meat
✦ Broil + circulated air	210 - 480 (100-250)	For casseroles, gratins, and whole poultry



### CAUTION

The oven door and exterior and the wire rack will become hot during Convection. Always use oven mits.

---



### ATTENTION

La porte du four et l'extérieur et la grille deviendront chauds en mode Convection. Utilisez toujours des gants de four.

---



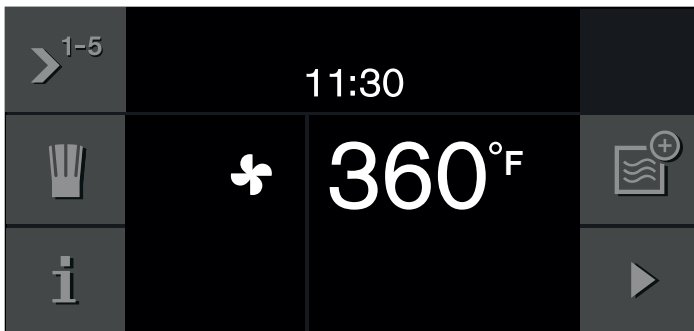

## Setting the type of heating and temperature

1. Use the function selector to set the required type of heating, e.g. "Convection".

The  symbol for "Convection" and the default temperature 360°F (180°C) appear in the display.





2. Set the temperature using the rotary selector.

**Note:** If required, you can now set the cooking time for your dish and delay the cooking-time end to a later time. Touch the  symbol; the sequential operation menu is displayed. Use  to select and set the  "Cooking time" function. Use  to select and set the  "Cooking-time end" function.

For more detailed information → "Sequential operation" on page 28

3. Start with .

The  heat-up symbol appears in the display (only if the oven temperature has been set to 210°F (100°C) or higher). The bars continuously display the heating status. When the set temperature has been reached, a signal sounds and the  heat-up symbol goes out.



If the "Quick heat" function is activated, the  symbol for "Quick heat" appears.

**Note:** You can activate or deactivate a heat-up signal in the basic settings. This signal sounds when the required temperature is reached.

You can change the temperature at any time using the rotary selector.

You can change the type of heating at any time using the function selector. Press  to restart.



### Pause:

The operation can be paused using the  symbol. Use the  symbol to continue.

### Switching off:

To stop the operation and cancel the settings, turn the function selector to 0.

### Calling up the current temperature:

Touch the  symbol to display the current oven temperature for several seconds (from 210°F (100°C)). Use the  symbol to return to the standard display.

**Note:** During continuous operation after heating up, slight deviations in temperature are normal, depending on the type of heating.

## Quick heat

Your appliance reaches the required temperature particularly fast with the "Quick heat" function.

So you achieve a uniform cooking result, do not place your meal in the oven interior until "Quick heat" has ended.

You must activate the "Quick heat" function in the basic setting. → "Basic Settings" on page 39

## Safety shut-off

For your protection, the appliance has a safety shut-off feature. Every heating operation is switched off after 12 hours if the appliance is not operated during this time. A message appears in the display.

### Exception:

programming with the long-term timer.

Turn the program selection to 0, after which you can operate the appliance in the manner to which you are accustomed.

---

## Broil

---

In broil mode, you can set three broil settings:

Type of heating	Broil setting	Usage
Broil	1 (low)	For soufflés and deep casseroles
	2 (medium)	For shallow casseroles and fish
	3 (high)	For steaks, sausages and toast

---



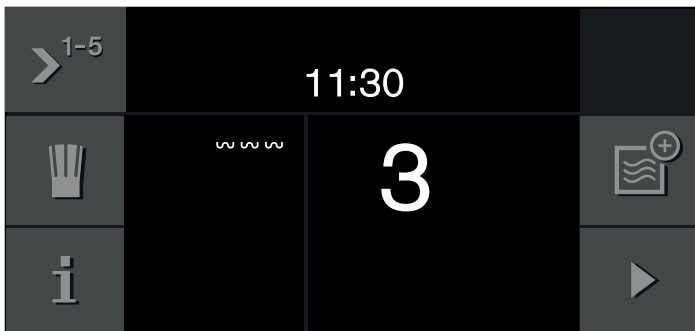

### Setting the Broil mode

1. Use the function selector to set the Broil mode.

The  Broil symbol and broil setting 3 appear in the display.



2. Use the rotary selector to set the broil setting.

**Note:** If required, you can now set the cooking time for your dish and delay the cooking time end to a later time. Touch the  symbol; the sequential operation menu is displayed. Use  to select and set the  "Cooking time" function. Use  to select and set the  "Cooking time end" function.



For more detailed information → "Sequential operation" on page 28

3. Start with .

You can change the broil setting at any time using the rotary selector.

You can change the operation mode at any time using the function selector. Press  to restart.

#### Pause:

The operation can be paused using the  symbol. Use the  symbol to continue.

#### Switching off:

To stop the operation and cancel the settings, turn the function selector to **0**.

---

## Combination mode

---

In combination mode, an oven heating type or the grill mode operate simultaneously with the microwave. Your dishes cook faster and are nicely browned.

You can switch on all microwave power settings. Exception: 1000 watts

You can also combine a type of heating with the sequential microwave operation.



### Setting the combination mode

1. Use the function selector to select the required type of oven heating or microwave output.

**Note:** You can start the combination mode with a type of oven heating or microwave output. In the following example, it is started with a type of oven heating.

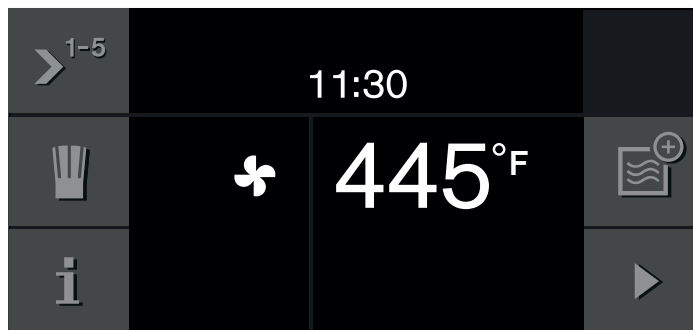
2. Set the oven temperature or grill setting using the rotary selector.



Depending on the operation mode selected, the  symbol for microwave or the  symbol for oven appears in the right-hand control panel, which enables you to add the relevant other operation mode.

3. Add a microwave output setting using the  symbol.
4. Set the required microwave output setting using the function selector.
5. Set the cooking time using the rotary selector.

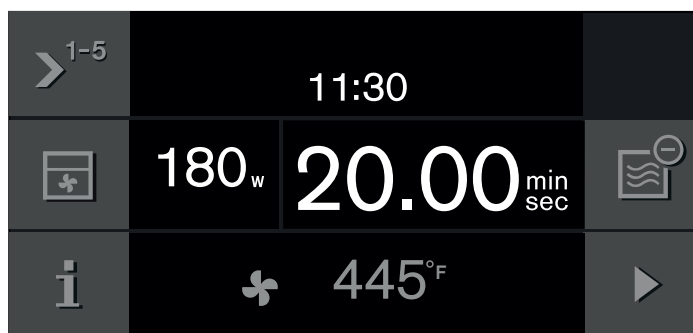



6. Start with .

The operation begins. The cooking time starts counting down.

An audible signal sounds once the cooking time has elapsed. The signal stops early if you touch the ✓ symbol, open the appliance door, or set the function selector to 0. The combination mode has finished.





### Changing settings

You can change the type of oven heating and oven temperature, the grill setting or the microwave output setting and cooking time. The changes can also be made during the operation; to do this, touch the || symbol. The operation stops.

1. Choose the operation mode using the  or  symbols.
2. Use the function selector to change the type of oven heating or the microwave output setting.
3. Use the rotary selector to change the oven temperature, grill setting, or the duration of the microwave output setting.
4. Start with ▶.

### Canceling settings

You can also delete the settings during the operation; to do this, touch the || symbol. The operation stops.

1. Choose the operation mode using the  or  symbols.
2. Cancel the type of heating using the  or  symbols.
3. Start with ▶.

### Pause:

The operation can be paused using the || symbol. Use the ▶ symbol to continue.

### Switching off:

To stop the operation and cancel the settings, turn the function selector to 0.

## Sequential operation

With a sequential operation, you can set up to five different types of heating and cooking times that are set one after another.

### Setting a series of operations

1. Select the required microwave output or type of oven heating using the function selector.

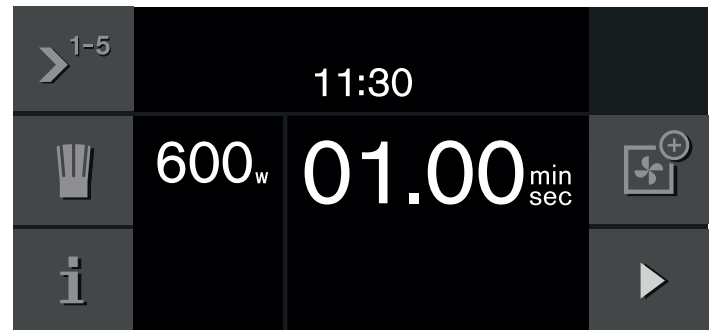

2. Touch the ><sup>1-5</sup> symbol.  
The sequential operation menu is displayed.
3. Set the cooking time, temperature or grill setting using the rotary selector.

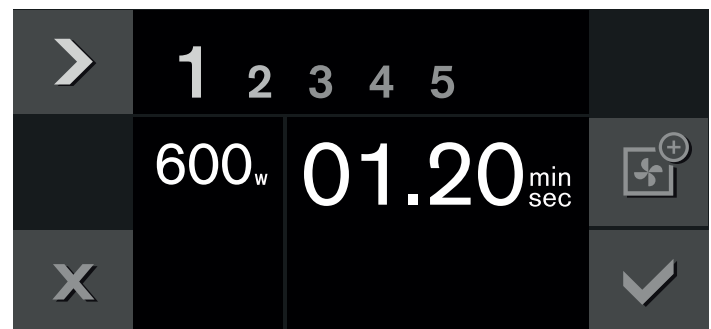

4. Use > to select the second phase.
5. Select the required microwave output or type of oven heating using the function selector. Set the cooking time, temperature or grill setting using the rotary selector.

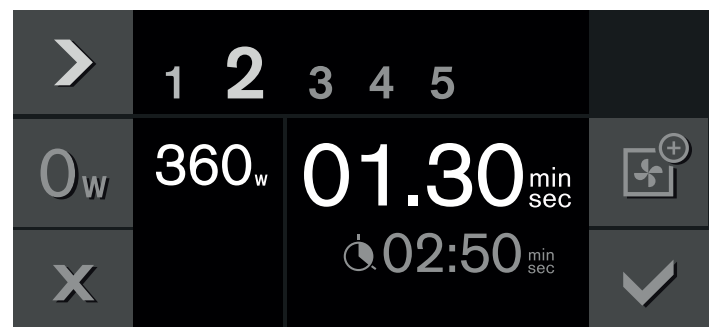

**Note:** You can set a stabilization time between two microwave outputs so that the temperature is distributed evenly within the food. To do this, touch the **0<sub>w</sub>** symbol and set a time using the rotary selector.

- Use **>** to select the third phase.
- Select the required microwave output or type of oven heating using the function selector. Set the cooking time, temperature or grill setting using the rotary selector.

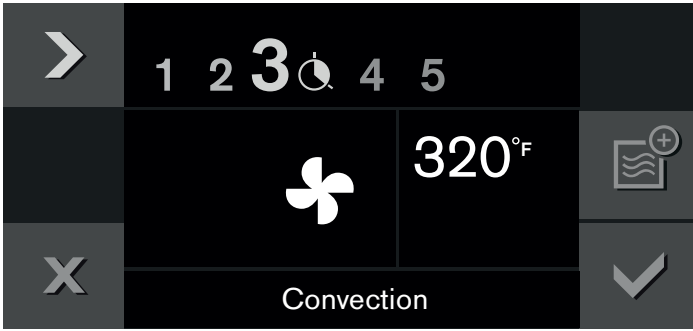

- Use **>** to select the **🕒** "Cooking time" function.
- Set the required cooking time using the rotary selector.

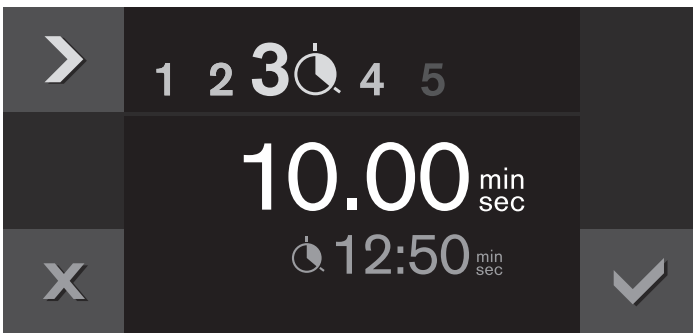

- Press **✓** to confirm.

The main menu for the sequential operation is displayed. The settings for each phase are shown in the display.

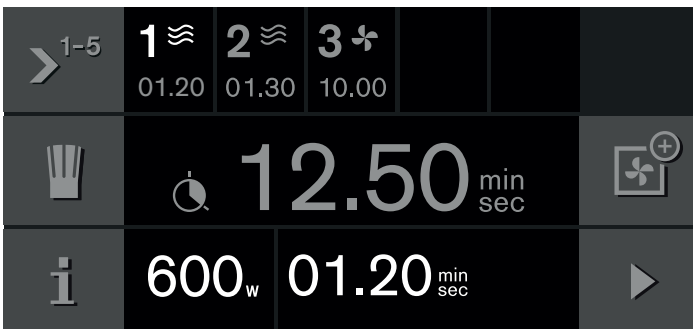

- Start with **▶**.

The operation begins. The cooking time starts counting down.

Once the cooking time has elapsed, the appliance switches off. An audible signal sounds. The signal stops early if you touch the **✓** symbol, open the appliance door, or set the function selector to **0**. The sequential operation has finished.

#### Changing the settings of the current phase:

Touch the **||** symbol. The operation stops. Touch the **><sup>1-5</sup>** symbol and change the settings. Use the **✓** symbol to exit the menu. Start with **▶**.

#### Deleting the settings:

Touch the **X** symbol.

#### Pause:

The operation can be paused using the **||** symbol. Use the **▶** symbol to continue.

#### Switching off:

To stop the operation and cancel the settings, turn the function selector to **0**.

#### Notes

- The sequential operation can be supplemented with the combination mode.
- The 1000-watt microwave output setting can only be selected once.
- The oven heating functions cannot be combined with the 1000-watt microwave output setting.
- The order of each setting is entirely up to you. You can start with the cooking time, microwave output or type of oven heating.
- If you open the appliance door during cooking, the fan may continue to run.

### End of cooking time

In oven mode, you can delay the cooking time end to a later time. This function is not available in conjunction with the microwave mode.

For example: It is 2:00 PM. The dish requires a cooking time of 40 minutes. You want it to be ready at 3:30 PM.

Enter the cooking time and delay the cooking time end until 3:30 PM. The electronics system calculates the start time. The appliance starts automatically at 2:50 PM and switches off at 3:30 PM.

Bear in mind that food that spoils easily should not be left in the oven for too long.

#### Delaying the cooking time end

You have set the type of heating, temperature, and cooking time.

- Use **>** to select the **🕒** "End of cooking time" function.

- Set the required cooking time end using the rotary selector.



- Press ✓ to confirm.

A message is shown in the display to warn that a cooking time end has been set. Press ✓ to confirm.

- Start with ▶.

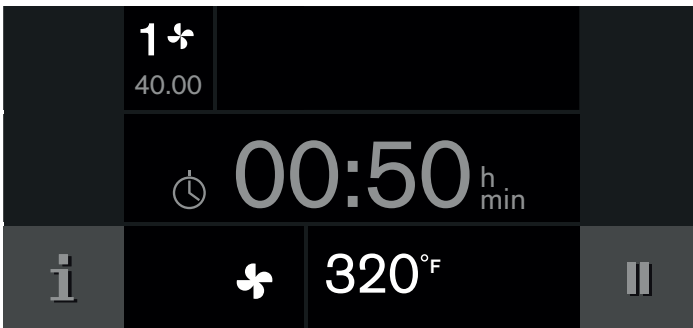

The appliance switches to standby. The display shows the operating mode, the temperature, the cooking time, and the remaining time until the start. The appliance starts at the calculated time and automatically switches off once the cooking time has elapsed.

Once the cooking time has elapsed, the appliance switches off. An audible signal sounds. The signal stops early if you touch the ✓ symbol, open the appliance door, or set the function selector to 0. The sequential operation has finished.

#### Changing the cooking time:

Touch the || symbol. Use > to select the ⌚ "Cooking time" function. Set the required cooking time using the rotary selector. Press ✓ to confirm. Start with ▶.

#### Changing the end of cooking time:

Touch the || symbol. Use > to select the ⌚ "End of cooking time" function. Set the required cooking time end using the rotary selector. Press ✓ to confirm. Start with ▶.

#### Deleting the settings:

Touch the X symbol.

#### To cancel the entire procedure:

Set the function selector to 0.

## Automatic programs

You can prepare food really easily using the automatic programs. You select the program and enter the weight of your food. The automatic program then applies the most suitable settings. You can select from 15 programs.

**Note:** The weight can only be set in kg.

### Setting a program

- Set the function selector to any operation mode.
 

**Note:** The function selector must not be moved to ⚙️ or S.
- Touch the 👨 "Chef's hat" symbol; the automatic programs are displayed.

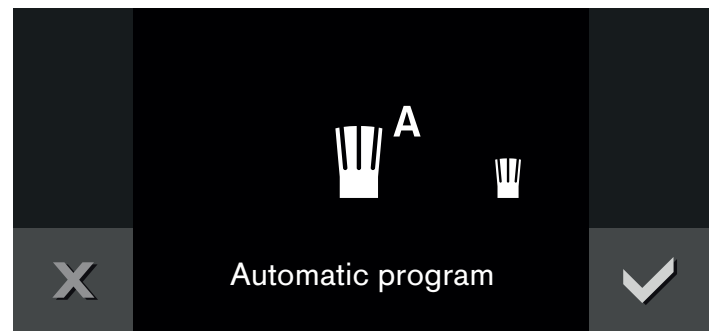

- Press ✓ to confirm.
 

The first program appears in the display.
- Use the rotary selector to select the required program, e.g. Cooking: "Fresh vegetables".

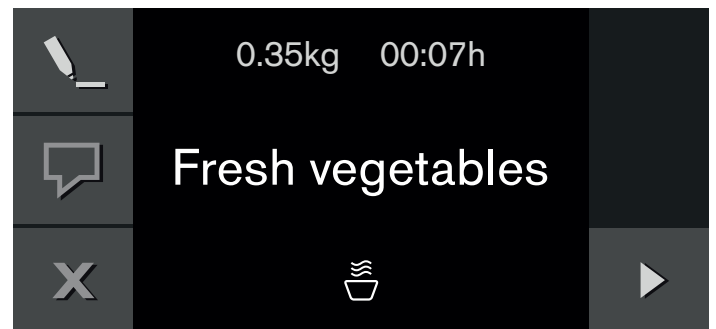

- Touch 📏 to select the 📏 "Weight" function.
- Turn the rotary selector to set the weight.
- Press ✓ to confirm.
- Start with ▶.



The operation begins. The cooking time starts counting down.

An audible signal sounds once the cooking time has elapsed. The signal stops early if you touch the ✓ symbol, open the appliance door, or set the function selector to 0. The program has finished.



### Resting time:

Some dishes require a resting time after the end of the program in order to reach an even temperature or to simmer. Wait until the resting time has elapsed before removing the food from the appliance.

### Tips:

Touch  to view tips on cookware, accessories, and shelf position. Exit this display using the  symbol.

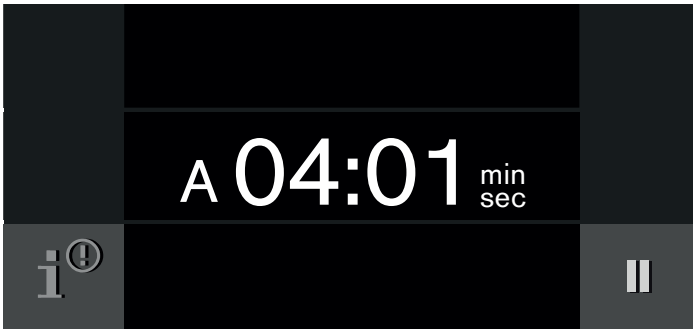

### Notes:

Use  to view notes on preparation. The  symbol appears for important information and indicates that an action is required. Exit this display using the  symbol.



For some dishes, the display provides instructions for turning or stirring during preparation. Follow the information provided. Opening the appliance door pauses the operation. After closing the appliance door, continue the operation by pressing . If you do not turn or stir the dish, the program runs as normal until it reaches the end.

### Pause:



The operation can be paused using the  symbol. Use the  symbol to continue.

### Switching off:

To stop the operation and cancel the settings, turn the function selector to **0**.

## Adjust individually

If the cooking result of a program does not suit you, you can adjust it individually before the program starts. Adjust the settings as described in points 1 to 4.

1. Touch  to select the individual settings.
2. Touch  to select the  "Cooking result" function.

3. Turn the rotary selector to set the cooking result.

To the left = cooking result less well done.

To the right = cooking result more well done.

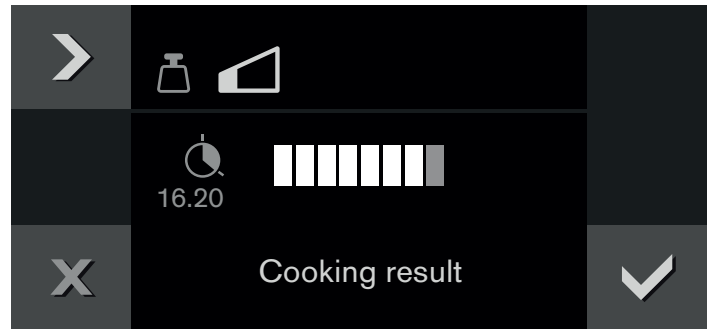

4. Press  to confirm.

The display changes to the program. The cooking time changes.

5. Start with .

The operation begins. The cooking time starts counting down.

**Note:** This change only applies for the current program flow. When the program is called up the next time, the original values of the automatic program apply.

## Tips for automatic programs

Place the food in the cold cooking compartment.

Take the food out of its packaging and weigh it. If it is not possible to enter the exact weight, you should round it up or down.

For the programs, always use microwavable cookware, for example made of glass or ceramic. Observe the accessories tips in the program table.

A table of suitable types of food with appropriate weight ranges and the accessories required can be found in the section after the notes.

It is not possible to set a weight outside the weight range.

With many dishes, a signal sounds after a certain time. Turn or stir the food.

### Defrosting:

- As far as possible, freeze and store food flat and in portion-sized quantities at  $-0.5^{\circ}\text{F}$  ( $-18^{\circ}\text{C}$ ).
- Place the frozen food in flat cookware, such as a glass or porcelain plate.
- After defrosting in the appliance, leave the food to continue defrosting for an additional 15 to 90 minutes until it reaches an even temperature.

- Liquid will be produced when defrosting meat or poultry. Drain off this liquid when turning meat and poultry and under no circumstances use it for other purposes or allow it to come into contact with other foods.
- Bread and rolls should only be defrosted in the required amounts, They will get stale quickly.
- Place frozen rolls in the oven. Suitable are only pre-baked rolls.
- After turning, remove any ground meat that has already defrosted.
- Whole poultry should be placed in the cookware breast-side down and poultry portions skin-side down.

**Vegetables:**

- Fresh vegetables: Cut into pieces of an equal size. Add one tablespoon of water for every 100 g vegetables.
- Frozen vegetables: This program is only suitable for blanched, not pre-cooked vegetables. It is not suitable for frozen vegetables in a cream sauce. Add 1 to 3 tablespoons of water. Do not add water to spinach or red cabbage.

**Baked potatoes:**

Use potatoes cut to the same thickness, washed, and dried. Pierce the peel.

**Rice:**

- Do not use brown or boil-in-the-bag rice.
- Add two to two-and-a-half times the amount of water to rice.

**Fish:**

Fish fillet, fresh: Add 1 to 3 tablespoons of water or lemon juice.

**Leg of lamb:**

First put the fat side down in the cookware. The leg of lamb should cover two thirds of the cookware bottom. Add 50-100 ml liquid.

**Poultry:**

- Place the chicken in the dish breast-side down.
- Place chicken portions in the cookware skin-side up.

**Pizza, frozen:**

Use pre-baked, frozen pizza with thin crust.

**Resting times:**

Some dishes need to rest in the oven after the program has ended.

Dish	Resting time
Vegetables	Approx. 5 minutes
Potatoes	Approx. 5 minutes First pour off the remaining water
Rice	5 to 10 minutes
Pork roast, meat loaf	10 minutes

**Program table**

	Suitable food	Weight range	Cookware/accessories, shelf height
<b>Defrosting</b>			
Loaf of bread*	Wheat bread, mixed wheat bread, whole-grain bread	7.1 oz - 3.3 lb (0.20 - 1.50 kg)	Shallow cookware without lid Cooking compartment floor
Rolls	wheat rolls, pre-baked	1.8 - 21.2 oz (0.05 - 0.60 kg)	Wire rack Height 1
Hamburger meat*	Hamburger beef, lamb, or pork	7.1 oz - 2.2 lb (0.20 - 1.00 kg)	Shallow cookware without lid Cooking compartment floor
Whole poultry*	Chicken, duck	24.7 oz - 4.4 lb (0.70 - 2.00 kg)	Shallow cookware without lid Cooking compartment floor

\* Observe the signals given when it is time to turn the food.



	Suitable food	Weight range	Cookware/accessories, shelf height
<b>Cooking</b>			
Fresh vegetables*	Cauliflower, broccoli, carrots, kohlrabi, leeks, peppers, zucchini	7.1 oz - 2.2 lb (0.20 - 1.00 kg)	Cookware with lid Cooking compartment floor
Frozen vegetables*	Cauliflower, broccoli, carrots, kohlrabi, red cabbage, spinach	5.3 oz - 2.2 lb (0.15 - 1.00 kg)	Cookware with lid Cooking compartment floor
Baked potatoes	Waxy potatoes, predominantly waxy potatoes or floury potatoes, approx. 2.5 in (64 mm) thick	7.1 oz - 4.4 lb (0.20 - 2.00 kg)	Cookware without lid Cooking compartment floor
Rice*	Rice, long-grain rice	3.5 - 17.6 oz (0.10 - 0.50 kg)	Deep cookware with lid Cooking compartment floor
Fresh fish fillet	Fillet of pike, cod, ocean perch, pollock, pike-perch	7.1 oz - 2.2 lb (0.20 - 1.00 kg)	Cookware with lid Cooking compartment floor
* Observe the stirring signals			
<b>Combi cooking</b>			
Frozen pizza	Pizza with thin crust, pre-baked	5.3 - 19.4 oz (0.15 - 0.55 kg)	Wire rack Height 3
Frozen lasagne	Lasagne bolognese	14.1 oz - 2.3 lb (0.40 - 1.05 kg)	Cookware without lid Cooking compartment floor
Fresh chicken*	Whole chicken	28.2 oz - 4.0 lb (0.80 - 1.80 kg)	Cookware with lid Cooking compartment floor
Fresh chicken portions	Chicken thigh, half chicken	17.6 oz - 3.5 lb (0.40 - 1.60 kg)	Cookware with lid Cooking compartment floor
Meat loaf	approx. 3 in (76 mm) deep	28.2 oz - 3.3 lb (0.80 - 1.50 kg)	Cookware without lid Cooking compartment floor
Leg of lamb	Leg of lamb or boneless shoulder of lamb	28.2 oz - 4.4 lb (0.80 - 2.00 kg)	Cookware without lid Cooking compartment floor





\* Observe the signals given when it is time to turn the food.

## Personal recipes

You have the option to save up to 50 individual recipes. You can record or program a recipe. You can enter a name for these recipes so that, if required, you can access them again quickly and easily.

### Recording a recipe

It is possible to set up to 5 phases consecutively and to record at the same time.

1. Select the required microwave output or type of oven heating using the function selector.  
The  symbol is displayed.
2. Touch the  symbol and select "Personal recipes" using the rotary selector.
3. Press  to confirm.
4. Use the rotary selector to select a free memory location.
5. Touch the  symbol.
6. Set the microwave cooking time, temperature or grill setting using the rotary selector.

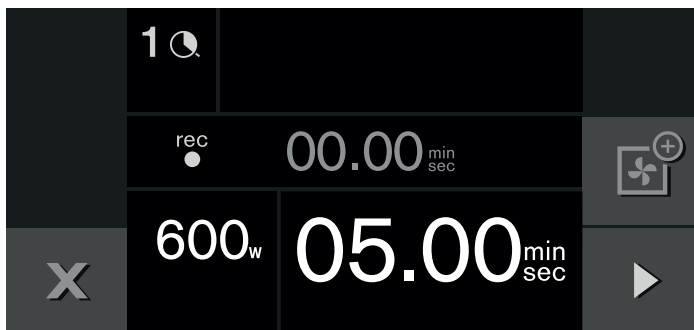

7. Start with .

The first phase is recorded, in this example, microwave output 600 W, microwave cooking time 5 minutes. The cooking time starts counting down in the display. After the cooking time has elapsed, you can record another phase.

**Note:** The phase can be stopped early using the  symbol.

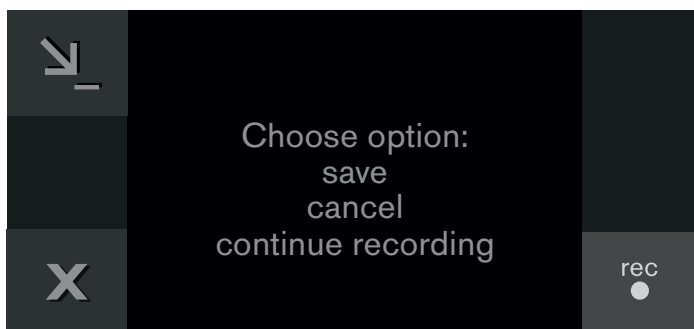

To proceed further, there are 3 options from which to choose.

To save: Touch the  symbol. The recipe is saved. Enter the name in "ABC". → "Entering a name" on page 35

To cancel: Touch the  symbol. The recipe is not saved.

To continue recording: Touch the  symbol. The recording is continued.

8. To continue recording: Touch the  symbol.
9. Select the required microwave output or type of oven heating using the function selector.

Set the microwave cooking time, temperature or grill setting using the rotary selector.

Example: Convection 320°F (160°C).

10. Start with .

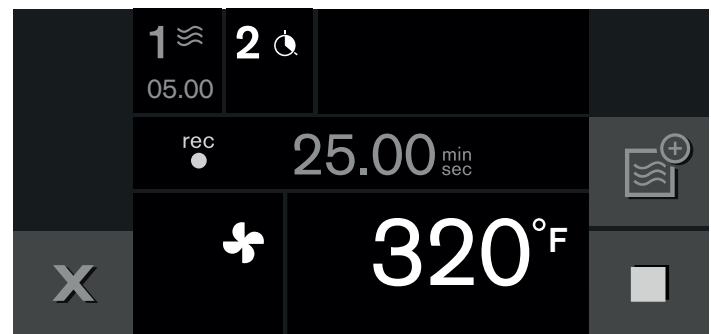

**Note:** Type of oven heating: The cooking time is recorded.

11. To finish this phase, touch the  symbol.

This phase is saved with the cooking time, in this example, 20 minutes.

12. To continue recording: Touch the  symbol.

- or -

If the dish has reached the desired cooking result, to stop saving the recipe.

13. To save: Touch the  symbol.







The recipe is saved. Enter the name in "ABC".  
→ "Entering a name" on page 35

### Notes



- If you open the appliance door, the recording of the phase ends.
- Operation in combination mode is possible.  
→ "Combination mode" on page 27

## Programming a recipe

You can program and save up to 5 preparation phases.

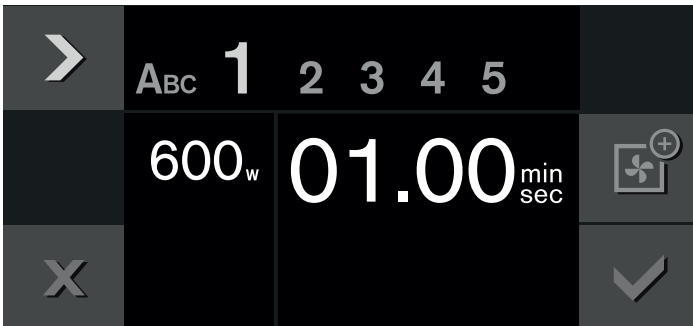
1. Select the required microwave output or type of oven heating using the function selector.  
The  symbol is displayed.
2. Touch the  symbol and select "Personal recipes" with the rotary selector.
3. Press  to confirm.
4. Use the rotary selector to select a free memory location.
5. Touch the  symbol.
6. Enter the name in "ABC". → "Entering a name" on page 35
7. Touch the  symbol.
8. Use the  symbol to select the first phase.  
The initial type of heating set is displayed. You can change the type of heating using the function selector. Operation in combination mode is possible. → "Combination mode" on page 27
9. Set the microwave cooking time, temperature or grill setting using the rotary selector.





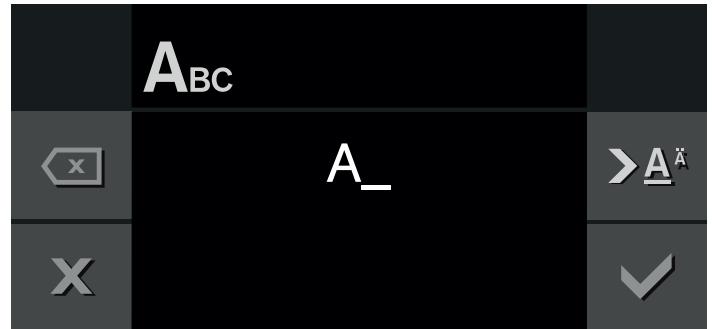

10. Use the  symbol to select the next phase.  
- or -  
If preparation is complete, finish making entries.
11. Save with .  
- or -  
Cancel with  and exit the menu.

## Entering a name

1. Enter the recipe's name under "ABC".





Rotary selector	Selecting letters A new word always begins with an upper case letter.
	Press briefly: cursor to the right Press long: switch to diacritics and special characters Press twice: insert line space
	Press briefly: cursor to the right Press long: switch to normal characters Press twice: insert line space
	Clear letters

2. Save with .  
- or -  
Cancel with  and quit the menu.

**Note:** For entering a name, Latin characters, certain special characters and numbers are available.

## Starting a recipe

1. Turn the function selector to any heating type.  
The  symbol is displayed.
2. Touch the  symbol and select "Personal recipes" using the rotary selector.
3. Press  to confirm.
4. Use the rotary selector to select the desired recipe.

## 5. Start with ▶.

The operation begins. The cooking time starts counting down.

The settings for each phase are shown in the display.

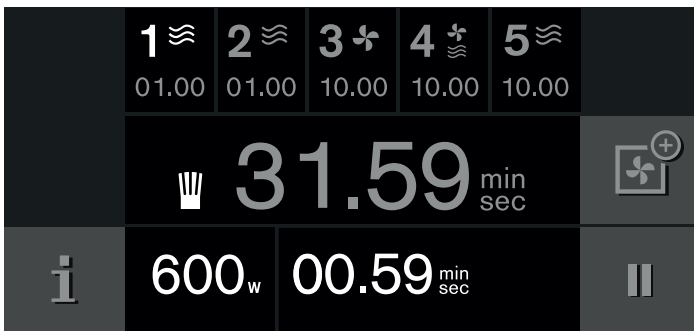

**Note:** You can change the type of oven heating and oven temperature, the grill setting or the microwave output setting and cooking time while the recipe is cooking. This does not change the saved recipe.

## Change recipe

You can change the settings of a recorded or programmed recipe.

1. Turn the function selector to any heating type.  
The symbol is displayed.
2. Touch the symbol and select "Personal recipes" using the rotary selector.
3. Press to confirm.
4. Use the rotary selector to select the desired recipe.
5. Touch the symbol.
6. Use the symbol to select the desired phase.

The settings are displayed. You can change the settings with the rotary selector or the function selector.

7. Save with .

- or -

Cancel with and exit the menu.

## Deleting a recipe

1. Set the program selection to any heating function.  
The symbol is displayed.
2. Touch the symbol. Select "Personal recipes" with the rotary selector.
3. Confirm with .
4. Set the required recipe with the rotary selector.
5. Clear the recipe with .
6. Confirm with .

## Timer functions

On the Timer menu, set:

- Timer
- Stop watch

## Launching the timer menu

The appliance must be activated and the function selector set to **0** or .

Touch the symbol.

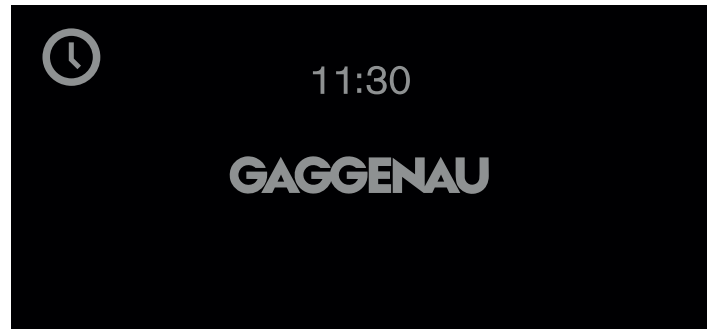

The Timer menu is displayed.

Do not use this element!

### Notes

- If you turn the function selector to a type of heating or basic setting **S** while the timer or stop watch is running, a note appears on the display. Confirm the note with the symbol, interrupt the timer or the stop watch. The appliance is ready to use.

In order to continue the timer or stop watch, turn the function selector back to **0** or light .

- The timer and stop watch can be operated simultaneously.

In the **0** position, only the timer is displayed.

In the Light position, the timer and stop watch are displayed.

## Timer

The timer only runs as long as no other function is set. You can enter a maximum of 90 minutes.

### Setting the timer

1. Call up the Timer menu.  
The "Timer" function ⌚ is displayed.
2. Turn the rotary selector to set the desired time.

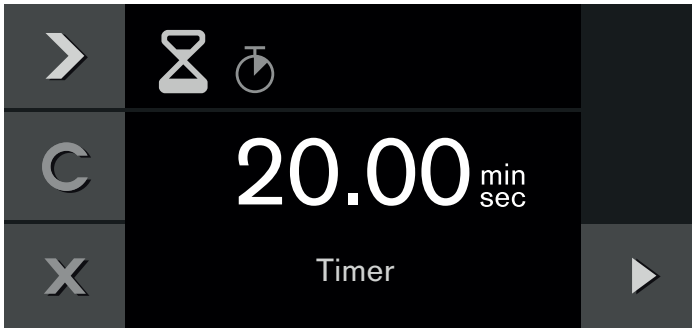

3. Start with ▶.

The Timer menu closes and the timer starts to run. The symbol for the timer ⌚ appears on the display and the time can be seen counting down.

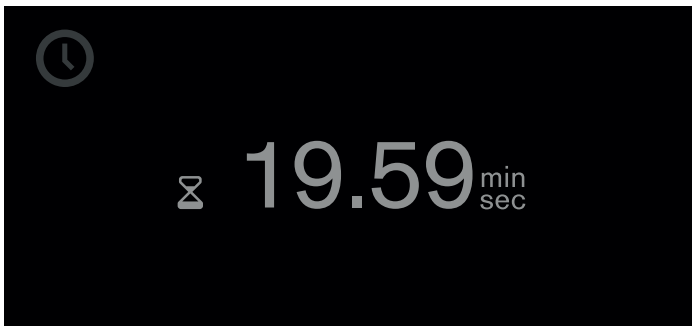

A signal sounds once the time has elapsed. The audible signal ceases if you touch the ✓ symbol.

You can exit the Timer menu at any time by touching the X symbol. This way, the settings are lost.

### Suspend timer:

Call up the Timer menu. Select the "Timer" function with >, select ⌚, and touch the || symbol. To let the timer run on, touch the ▶ symbol.

### Switch off the timer early:

Call up the Timer menu. Select the "Timer" function with >, select ⌚, and touch the C symbol.

## Stopwatch

The stop watch only runs as long as no other function is set.

The stop watch counts from 0 seconds up to 90 minutes. It has a pause function. This allows you to stop the stop watch from time to time.

### Starting the stopwatch

1. Launch the timer menu.
2. With >, select the "Stopwatch" function ⌚.

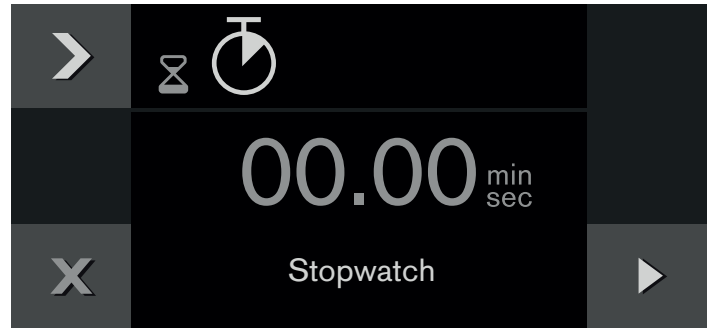

3. Start with ▶.

The timer menu is closed and the time runs. The ⌚ symbol and the elapsing timer are shown in the display.

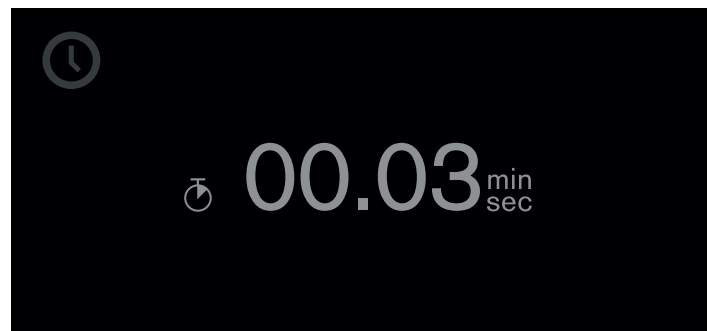

### Stopping and restarting the stopwatch

1. Launch the timer menu.
2. With >, select the "Stopwatch" function ⌚.
3. Touch the || symbol.

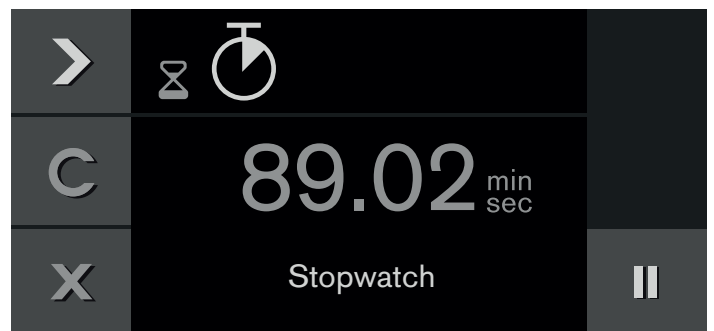

The time stops. The symbol changes to Start ▶ again.

4. Start with ▶.

The time continues to run. Once 90 minutes have been reached, the display pulsates and a signal sounds. It goes off when you touch the ✓ symbol. The ⌚ symbol disappears from the display. The operation has ended.

### Switching off the stopwatch:

Launch the timer menu. With >, select the "Stopwatch" function ⌚ and touch the C symbol.

---

## Sabbath mode

---

With this function, the appliance uses the heating mode Convection to hold a temperature of 185°F (85°C).



You can keep food warm for up to 74 hours without having to switch the appliance on and off.

Bear in mind that food that spoils easily should not be left in the oven for too long.



### Notes

- You have to set the Sabbath mode to "available" in the basic settings. → "Basic Settings" on page 39
- The Sabbath mode time cannot be selected if the timer or stop watch are activated.

### Setting the Sabbath mode

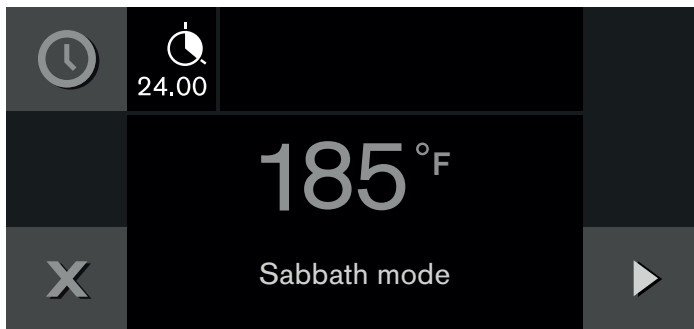
1. Set the function selector to .
2. Touch the  symbol.  
24 h at 185°F (85°C) appears in the display as a default value.
3. Touch the  symbol.



4. Set the required cooking time  using the rotary selector.
5. Press  to confirm.
6. Start with .

The appliance starts.  and the temperature appear on the display.

Oven and display lighting are switched off. The control panel is locked; no tones sound if it is touched.

When the time has elapsed, the appliance does not heat up anymore. Turn the function selector to **0**.

### Switching off:

To cancel the transaction, turn the function selector to **0**.

---

## Child lock

---

The appliance has a child lock to make sure children cannot operate it inadvertently.

### Notes

- You must set the child lock in the basic setting to "Available". → "Basic Settings" on page 39
- If there is a power cut while the child lock is activated, it may be deactivated when the power returns.

## Activating the child lock

### Requirement:

Program selector is set to **0**.

Touch the  symbol for at least 6 seconds.

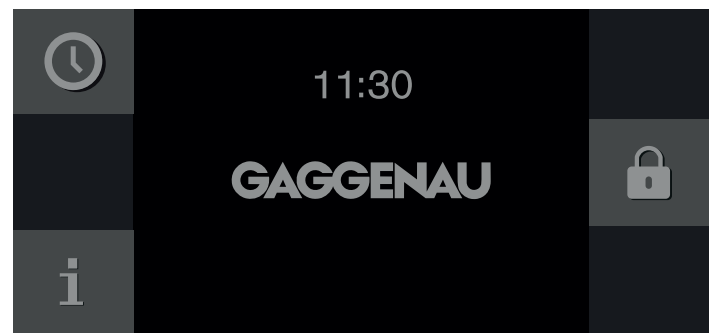

The child lock is activated. The standby screen appears. The  appears at the top of the display.

## Deactivating the child lock

### Requirement:

Program selector is set to **0**.

Touch the  symbol for at least 6 seconds.

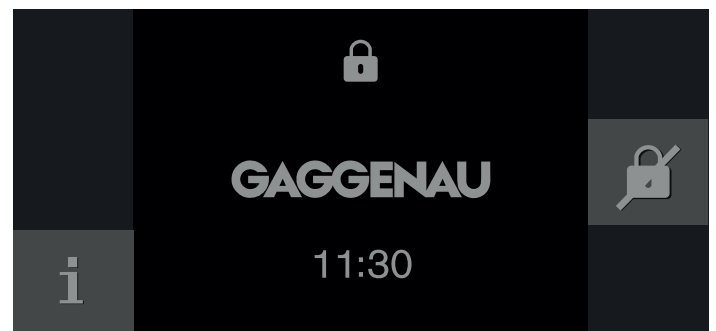

The child lock is deactivated. You can switch on the appliance in the usual manner.



## Basic Settings

The basic settings of your appliance can be adjusted individually.













1. Rotate function selector to **S**.









You are now in the "Basic settings" menu.

2. Select the desired basic setting using the rotary selector.

3. Touch the  symbol.
4. You can change the basic setting by turning the rotary selector.
5. Use  to save or  to cancel and exit the current basic setting.
6. Turn the function selector to **0** to exit the basic settings menu.

The changes are saved.

	Basic setting	Possible settings	Explanation
	Brightness	Stages 1, 2, 3, 4, 5*, 6, 7, 8	Setting display brightness
	Standby screen	On*/Off - Clock - Clock + GAGGENAU logo* - Date - Date + GAGGENAU logo - Clock + date - Clock + date + GAGGENAU logo	Appearance of the standby screen. Off: no display. Use this setting to reduce the standby consumption of your appliance. On: several displays can be set, confirm "On" with  and choose the desired display with the rotary selector. The selection is displayed.
	Display screen	Minimized*/Standard	When 'Minimized' is set, only the most important details are displayed after a short time.
	Touchpad color	Gray*/White	Select the color of symbols on the touchpads
	Touchpad tone	Tone 1*/Tone 2/Off	Select the signal tone when touching a touchpad
	Touchpad volume	Levels 1, 2, 3, 4, 5*, 6, 7, 8	Sets the volume of the touchpad tone
	Signal volume	Levels 1, 2, 3, 4, 5*, 6, 7, 8	Sets the volume of the signal tone
	Preheating speed/signal	Preheating with signal* Quick heat with signal Preheating without signal Quick heat without signal	The audible signal sounds when the desired temperature is reached during preheating. With quick heat, the desired temperature is reached especially fast.
	Time format	AM/PM / 24 h*	Time display in 24 or 12-hour format
	Time	Current time	Setting the time
	Daylight savings	Manual*/Automatic	Automatic time changeover when changing daylight savings time. If automatic: setting of the month, day and week when the time is to be changed. To be set separately for summer and winter time.

	Date format	D.M.Y* D/M/Y M/D/Y	Setting the date format
	Date	Current date	Setting the date. Switch between the year/month/day with the > symbol.
	Temperature format	°C*/°F	Set the temperature unit
	Language	German* / French / Italian / Spanish / Portuguese / Dutch / Danish / Swedish / Norwegian / Finnish / Greek / Turkish / Russian / Polish / Czech / Slovenian / Slovakian / Arabic / Hebrew / Japanese / Korean / Thai / Chinese / English US / English	Select language for the text display <b>Note:</b> When the language is changed, the system is restarted; this procedure takes a few seconds. Then the General settings menu is closed.
	Factory settings	Restore appliance to factory settings	Confirm the question "Delete all individual settings and restore appliance to factory settings?" with ✓ or cancel with ✕. <b>Note:</b> When restoring factory settings, the personal recipes are also deleted. After restoring the factory settings, you will see the "Initial settings" menu.
	Demo mode	On/Off*	For presentation purposes only. The appliance does not heat in the demo mode, but all other functions are available.  The "Off" setting must be activated for normal operation. The setting is only possible in the first three minutes after connecting the appliance.
	Sabbath mode	Not Available* / Available	Available: Sabbath mode can be set. → "Sabbath mode" on page 38
	Child lock	Not Available* / Available	Available: the child lock can be activated. → "Child lock" on page 38

\* Factory settings



---

## Cleaning

---

If taken care of and cleaned conscientiously, your appliance will stay beautiful and intact for a long time. Here we explain how to take care of and clean your appliance correctly.

**Note:** Unpleasant odors, for example after fish has been prepared, can be removed very easily. Add a few drops of lemon juice to a cup of water. Always place a glass rod/ spoon in the container to prevent delayed boiling. Heat the water for 1 to 2 minutes at maximum microwave output.

---

### WARNING

---

Be sure the entire appliance has cooled and grease has solidified before attempting to clean any part of the appliance.

---

---

### AVERTISSEMENT

---

Assurez-vous que l'appareil tout entier s'est refroidi et que la graisse s'est solidifiée avant de tenter de nettoyer une partie quelconque de l'appareil.

---

---

### WARNING

---

#### **Risk of burns!**

The appliance becomes very hot. Never touch the hot inside surfaces of the oven interior or heating elements. Always allow the appliance to cool down. Keep children away.

---

---

### AVERTISSEMENT

---

#### **Risque de brûlure**

L'appareil chauffe beaucoup. Ne jamais toucher aux surfaces intérieures du four chaud ni aux résistances chauffantes. Toujours laisser l'appareil refroidir. Tenir les enfants à distance.

---

---

### WARNING

---

#### **Risk of electrical shock!**

Moisture entering the appliance can cause an electrical shock. Don't use a high-pressure cleaner or steam cleaner.

---

---

### AVERTISSEMENT

---

#### **Risque de choc électrique**

La pénétration d'humidité peut provoquer un choc électrique. Ne pas utiliser de nettoyeur à haute pression ou à vapeur.

---

---

### WARNING

---

#### **Risk of injury!**

Scratched glass in the appliance door can burst. Do not use any glass scrapers or strong or abrasive cleaning agents.

---

---

### AVERTISSEMENT

---

#### **Risque de blessure**

Lorsque le verre de la porte est rayé, il peut sauter. Ne pas utiliser de grattoir à verre, ni de produits agressifs ou abrasifs.

---

## Self-cleaning surface in the cooking compartment

The back panel of the oven is coated with self-cleaning enamel. It cleans itself while the oven is in operation. Sometimes, larger splashes of food may not disappear until the oven has been operated several times. You can remove remains of spices and similar with a dry cloth or a soft brush.

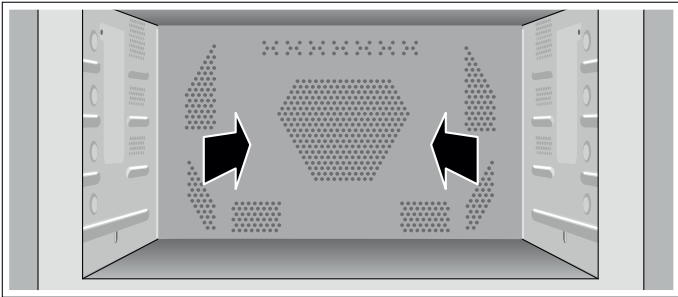

### Notes

- Never treat the self-cleaning surface with oven cleaner. If oven cleaner accidentally gets onto the rear wall, remove it immediately with a sponge and plenty of water.
- Never use abrasive cleaning agents. You will scratch or destroy the highly porous coating.
- Never clean the self-cleaning surface with a scouring pad.
- Light discoloration of the enamel does not affect self-cleaning.

Cleaning the bottom of the cooking compartment, ceiling, and side walls: Use a dish rag and hot soapy water or vinegar solution.

## Cleaning agent

To ensure that the different surfaces are not damaged by using the wrong cleaning agent, observe the information in the table.

Do not use:

- Harsh or abrasive cleaning agents.
- Metal or glass scrapers to clean the glass in the appliance door.
- Metal or glass scrapers to clean the door seal.
- Hard scouring pads or sponges.

Wash new sponge cloths thoroughly before use.

Area	Cleaning agent
Appliance front	Hot soapy water: Clean using a dish cloth and then dry with a soft cloth. Do not use a metal or glass scraper for cleaning.
Display	Wipe down using a microfiber cloth or a slightly damp cloth. Do not wipe with a wet cloth.
Stainless steel	Hot soapy water: Clean using a dish cloth and then dry with a soft cloth. Remove flecks of limescale, grease, starch and albumin (e.g. egg white) immediately. Corrosion can form under such flecks. Special stainless-steel cleaning agents are available from customer service or from specialist retailers.
Aluminum	Clean with a mild window cleaning agent. Using a window cloth or a non-fluffing microfiber cloth, wipe over the surfaces lightly in a horizontal direction.
Cooking compartment (self-cleaning back wall)	Do not use oven cleaner! Remove residue with dry cloth or soft brush. Refer to section "Self-cleaning surface in the cooking compartment"
Cooking compartment (except for stainless steel)	Hot soapy water or vinegar solution: Clean using a dish cloth and then dry with a soft cloth. If oven is very dirty: use oven cleaner, but only when oven is cold.
Cooking compartment made of stainless steel	Do not use oven spray or any other aggressive oven cleaners or abrasive materials. Scouring pads, rough sponges and pan cleaners are also unsuitable. These items scratch the surface. Allow the interior surfaces to dry thoroughly.
Very dirty stainless steel or enameled cooking compartment	Oven cleaner gel (order number 463582 from customer service or in the online shop).  <b>Please note:</b> <ul style="list-style-type: none"> <li>• May not get on seals on the door and lamp!</li> <li>• Soak for max. 12 hours.</li> <li>• Do not use on warm surfaces.</li> <li>• Rinse thoroughly with water.</li> <li>• Observe the manufacturer's instructions.</li> </ul>

<b>Area</b>	<b>Cleaning agent</b>
Glass cover for the cooking compartment light	Hot soapy water: Clean with a dish cloth.
Door panels	Glass cleaner: Clean with a dish cloth. Do not use a glass scraper.
Do not remove door seal.	Hot soapy water: Clean with a dish cloth and do not scour. Do not use a metal or glass scraper for cleaning.
Accessories	Hot soapy water: Soak and clean with a dish cloth or brush.

### **Cleaning the glass cover**

The glass oven-light cover is located on the left side wall inside the oven. Undo the screw from the cover. Then you can clean the glass with soapy water.

---

### **WARNING**

#### **Risk of burns!**

The glass cover for the oven light gets hot. Only touch the glass cover with temperature-resistant gloves.

---

---

### **AVERTISSEMENT**

#### **Risque de brûlures**

Le couvercle en verre de la lampe du four devient chaud. Touchez le couvercle en verre uniquement avec des gants résistant à la température.

---

---

## Troubleshooting

---

You can often easily eliminate problems that may occur on your own. Before calling customer service, take into account the following information.

---

### WARNING

---

#### Risk of electric shock!

Incorrect repairs are dangerous. Repairs may only be carried out by one of our trained after-sales engineers. If the appliance is faulty, unplug the mains plug or switch off the fuse in the fuse box. Contact the after-sales service.

---

---



### AVERTISSEMENT

---

#### Risque de choc électrique

Les réparations non-conformes sont source de danger. Les réparations doivent être faites exclusivement par un technicien après-vente formé par nos soins. Si l'appareil est défectueux, débranchez la fiche d'alimentation secteur ou désactivez le coupe-circuit concerné sur le tableau électrique. Appelez le service après-vente.

---

Disruption	Possible cause	Solution
Appliance not working, no display	Power failure	Check whether other kitchen appliances are working.
	Fuse defective	Have a qualified electrician check in the fuse box whether the fuse for the appliance is in working order.
	Operating error	Switch off the fuse for the appliance in the fuse box and switch it on again after about 10 seconds.
Appliance cannot be started	Appliance door is not quite closed	Close appliance door
The food takes longer than usual to heat up	The microwave power setting is too low	Select a higher power setting
	A larger amount than usual has been placed in the appliance	Double the amount = almost double the time
	The food was colder than usual.	Stir or turn the food during cooking
Appliance is not working, display is not responding.  appears in the display.	Child lock activated	Deactivate child lock (see section entitled 'Child lock')
Appliance does not heat up,  appears in the display	Appliance is in the demo mode	Deactivate demo mode in the basic settings
Error Message E300	Incorrect wiring at first power up	Check wiring of appliance at connection point. Wiring should be checked by a qualified person.
	L1 & L2 not powered up simultaneously	Power on L1 & L2 simultaneously.
	Failure module combination	Please contact after-sales service and inform them of the error code.
Error message "Exxx"		If an error message appears, turn the program selection to 0; if the display goes off, it was a one-time problem. If the problem occurs repeatedly or if the display stops, please contact after-sales service and inform them of the error code.

---

## Power cut

Your appliance can bridge a power cut of a few seconds. Operation continues.

If the power cut was for a longer period and the appliance was in operation, a message appears in the display. Operation is interrupted.

Set the function selector to **0**, then the appliance can be operated again as usual.

## Demo mode

The demo mode is activated if the  symbol appears in the display. The appliance does not heat up.

Briefly disconnect the appliance from the mains (switch off the domestic fuse or the circuit-breaker in the fuse box). Then deactivate the demo mode within 3 minutes in the basic setting. → *"Basic Settings" on page 39*

---

## Technical Specifications

---

Power supply	208/240 V, 60 Hz
Max. total connected load	3,300 W
Microwave output	1,000 W (IEC 60705)
Max. grill output power	2,000 W
Convection output power	1,600/2,100 W
Microwave frequency	2,450 MHz
Fuse	20 A
Appliance dimensions W/H/D	23 <sup>1</sup> / <sub>4</sub> " x 17 <sup>7</sup> / <sub>8</sub> " x 22" (590 mm x 455 mm x 559 mm)
Overall volume	1.3 cu.ft (37 l)
Usable oven space	1.3 cu.ft (36 l)
Overall oven interior dimensions W/H/D	17 <sup>1</sup> / <sub>2</sub> " x 9 <sup>3</sup> / <sub>8</sub> " x 13 <sup>7</sup> / <sub>8</sub> " (445 mm x 239 mm x 352 mm)
Usable oven interior dimensions W/H/D	17" x 9 <sup>1</sup> / <sub>4</sub> " x 13 <sup>3</sup> / <sub>4</sub> " (432 mm x 236 mm x 350 mm)

---

---

## Customer service

---

If your appliance needs repairs, our customer service is there for you. We work hard to help solve problems quickly and without unnecessary service calls, getting your appliance back up and running correctly in the least amount of time possible.

When you call, please indicate the product number (E-Nr.) and serial number (FD-Nr.) so that we can support you in a qualified manner. You will find the type plate with these numbers at the inside of the appliance door. To avoid having to search for a long time when you need it, you can enter your appliance data and the customer support telephone number here.

---

**E-Nr.** **FD-Nr.**

---

---

**Customer Service** ☎

---

Please read the use and care instructions provided with your appliance. Failure to do so may result in an error in using the appliance. This could result in a service call that instead of fixing a mechanical issue is only needed for customer education. Such calls are not covered by the appliance warranty.

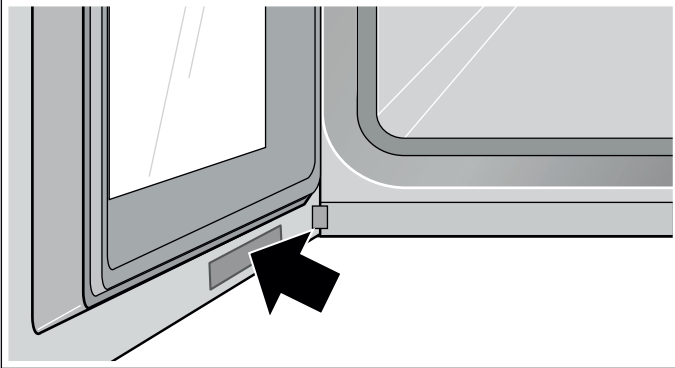

Please find the contact data of all countries in the enclosed customer service list.

### To book an engineer visit and product advice

**USA** 877 442 4436  
toll-free

**CANADA** 877 442 4436  
toll-free

You can rely on the manufacturer's expertise. Rest assured that the repair will be handled by trained service technicians who have the original replacement parts for your appliance.

---

## Tables and tips

---

Here, you can find a selection of dishes and the ideal settings for them. We will show you which type of heating and which temperature or microwave power setting is best for your meal. You can find information about suitable accessories and the height at which they should be inserted. There are also tips about cookware and preparation methods.

Do not use this element!

### Notes

- The values in the table always apply to food placed in the cooking compartment when it is cold and empty. Only preheat the appliance if the table specifies that you should do so. Before using the appliance, remove all accessories from the cooking compartment that you will not be using.
- Do not line the accessories with greaseproof paper until after they have been preheated.
- The times specified in the tables are only guidelines. They will depend on the quality and composition of the food.
- Use the accessories provided. Additional accessories may be obtained as optional accessories from specialist retailers or from customer service.
- Always use an oven cloth or oven gloves when taking hot accessories or cookware out of the cooking compartment.

---

### WARNING

---

#### Risk of scalding!

When pulling out the glass tray, hot liquid may overflow. Carefully pull the glass tray out of the cooking compartment.

---

---

### AVERTISSEMENT

---

#### Risque de brûlure

Du liquide chaud peut déborder lors du retrait de la lèchefrite en verre. Retirez prudemment la lèchefrite en verre du compartiment de cuisson.

---

The following tables provide you with numerous options and settings for the microwave.

The times given in the tables are guidelines; they depend on the cookware used, and the quality, temperature and consistency of the food.

Time ranges are often specified in the tables. Set the shortest time first and then extend the time if necessary.

It may be that you have different quantities from those specified in the tables. There is a rule of thumb for operating the microwave: Double the amount = double the time, half the amount = half the time.

You can place the cookware in the middle of the wire rack or on the cooking compartment floor. The food will then absorb the microwaves from all sides.

## Defrosting

Place the frozen food in an open container on the oven floor.

Delicate parts such as chicken legs and wings or fatty outer layers of roasts can be covered with small pieces of aluminum foil. The foil may not touch the walls of the appliance. You can remove the foil halfway through the defrosting time.

Turn or stir the food once or twice during the defrosting time. Large pieces of food should be turned several times. When turning, remove any liquid that has been produced during defrosting.

Leave defrosted items to stand at room temperature for an additional 10 to 60 minutes so that the temperature can even out. You can remove the giblets from poultry at this point.

**Note:** Place the cookware on the cooking compartment floor.

---

**⚠ WARNING**

---

**Health Risk!**

Liquid will be produced when defrosting meat or poultry. Drain off this liquid when turning meat and poultry, and under no circumstances, use it for other purposes, or allow it to come into contact with other foods.

---

---

**⚠ AVERTISSEMENT**

---

**Risques à la santé**

Du liquide sera produit lors de la décongélation de viande ou de volaille. Drainez ce liquide quand vous retournez la viande ou la volaille et en aucune circonstance devriez-vous l'utiliser à d'autres fins ou lui permettre d'entrer en contact avec d'autres aliments.

---

Dish	Amount	Microwave power in watts, cooking time in minutes	Notes
Whole pieces of beef, pork or veal (on the bone or boned)	28.2 oz (800 g)	180 W, 15 min. + 90 W, 15 - 25 min.	Turn several times.
	2.2 lb (1000 g)	180 W, 15 min. + 90 W, 25 - 35 min.	
	3.3 lb (1500 g)	180 W, 20 min. + 90 W, 25 - 35 min.	
Meat in pieces or slices of beef, veal or pork	7.1 oz (200 g)	180 W, 5 min. + 90 W, 4 - 6 min.	Separate the slices/pieces of meat when turning.
	17.6 oz (500 g)	180 W, 10 min. + 90 W, 5 - 10 min.	
	28.2 oz (800 g)	180 W, 10 min. + 90 W, 10 - 15 min.	
Hamburger meat, mixed	7.1 oz (200 g)	90 W, 15 min.	Freeze food flat if possible. Turn several times during defrosting and remove any Hamburger meat that has already defrosted.
	17.6 oz (500 g)	180 W, 5 min. + 90 W, 10 - 15 min.	
	28.2 oz (800 g)	180 W, 10 min. + 90 W, 15 - 20 min.	
Poultry or poultry portions	21.2 oz (600 g)	180 W, 5 min. + 90 W, 10 - 15 min.	Turn during defrosting. Remove liquid that escapes during defrosting.
	2.6 lb (1200 g)	180 W, 10 min. + 90 W, 20 - 25 min.	
Duck	4.4 lb (2000 g)	180 W, 20 min. + 90 W, 30 - 40 min.	Turn several times. Remove liquid that escapes during defrosting.
Goose	9.9 lb (4500 g)	180 W, 30 min. + 90 W, 60 - 80 min.	Turn every 20 minutes. Remove liquid that escapes during defrosting.
Fish Fillet, fish steak, slices	14.1 lb (400 g)	180 W, 5 min. + 90 W, 10 - 15 min.	Separate any defrosted parts.
Whole fish	10.6 oz (300 g)	180 W, 3 min. + 90 W, 10 - 15 min.	Turn during defrosting.
	21.2 oz (600 g)	180 W, 8 min. + 90 W, 15 - 25 min.	
Vegetables, e.g. peas	10.6 oz (300 g)	180 W, 10 - 15 min.	Stir carefully during defrosting.
	21.2 oz (600 g)	180 W, 10 min. + 90 W, 8 - 13 min.	



Dish	Amount	Microwave power in watts, cooking time in minutes	Notes
Fruit, e.g. raspberries	10.6 oz (300 g) 17.6 oz (500 g)	180 W, 7 - 10 min. 180 W, 8 min. + 90 W, 5 - 10 min.	Stir carefully during defrosting and separate any defrosted parts.
Butter, defrosting	4.4 oz (125 g) 8.8 oz (250 g)	90 W, 6 - 8 min. 180 W, 2 min. + 90 W, 3 - 5 min.	Remove all packaging.
Bread, loaf	17.6 oz (500 g) 2.2 oz (1000 g)	180 W, 3 min. + 90 W, 10 - 15 min. 180 W, 5 min. + 90 W, 15 - 25 min.	Turn during defrosting.
Cakes, dry, e.g. sponge cake	17.6 oz (500 g) 26.5 oz (750 g)	90 W, 10 - 15 min. 180 W, 3 min. + 90 W, 10 - 15 min.	Separate the pieces of cake. Only for cakes without icing, whipped cream or crème pâtissière.
Cakes, moist, e.g. cake topped with fruit, cheesecake	17.6 oz (500 g) 26.5 oz (750 g)	180 W, 5 min. + 90 W, 15 - 25 min. 180 W, 7 min. + 90 W, 15 - 25 min.	Only for cakes without icing, whipped cream or gelatin.

## Defrosting, heating up or cooking frozen food

Take ready meals out of the packaging. They will heat up more quickly and evenly in microwavable cookware. The different components of the meal may not require the same amount of time to heat up.

Food that lies flat will cook more quickly than food that is piled high. You should therefore distribute the food so that it is as flat as possible in the cookware. Food should not be placed in layers on top of one another.

Always cover the food. If you do not have a suitable cover for your container, use a plate or special microwave foil.

Stir or turn the food 2 or 3 times during cooking.

After heating, allow the food to stand for an additional 2 to 5 minutes to allow the temperature to even out.

This will help the food retain its own distinct taste, so it will require less seasoning.

**Note:** Place the cookware on the cooking compartment floor.

Dish	Amount	Microwave power in watts, cooking time in minutes	Notes
Menu, plated meal, ready meal (2-3 components)	10.6 - 14.1 oz (300 - 400 g)	600 W, 11 - 15 min.	Covered
Soups	14.1 - 17.6 oz (400 - 500 g)	600 W, 8 - 13 min.	Cookware with lid
Stew	17.6 oz (500 g) 2.2 lb (1000 g)	600 W, 11 - 15 min. 600 W, 20 - 25 min.	Cookware with lid
Slices or pieces of meat in sauce, e.g. goulash	17.6 oz (500 g) 2.2 lb (1000 g)	600 W, 12 - 17 min. 600 W, 25 - 30 min.	Cookware with lid

Dish	Amount	Microwave power in watts, cooking time in minutes	Notes
Fish, e.g. fillet steaks	14.1 oz (400 g)	600 W, 10 - 15 min.	Covered
	28.2 oz (800 g)	600 W, 20 - 25 min.	
Side dishes, e.g. rice, pasta	8.8 oz (250 g)	600 W, 2 - 5 min.	Cookware with lid, add liquid
	17.6 oz (500 g)	600 W, 8 - 10 min.	
Vegetables, e.g. peas, broccoli, carrots	10.6 oz (300 g)	600 W, 8 - 10 min.	Cookware with lid, add 1 tbsp of water
	21.2 oz (600 g)	600 W, 14 - 17 min.	
Creamed spinach	15.9 oz (450 g)	600 W, 11 - 16 min.	Cook without additional water

## Heating food

### WARNING

#### Risk of scalding!

There is a possibility of delayed boiling when a liquid is heated. This means that the liquid reaches boiling temperature without the usual steam bubbles rising to the surface. Even if the container only vibrates a little, the hot liquid may suddenly boil over and spatter. When heating liquids, always place a glass rod/spoon in the container. This will prevent delayed boiling.

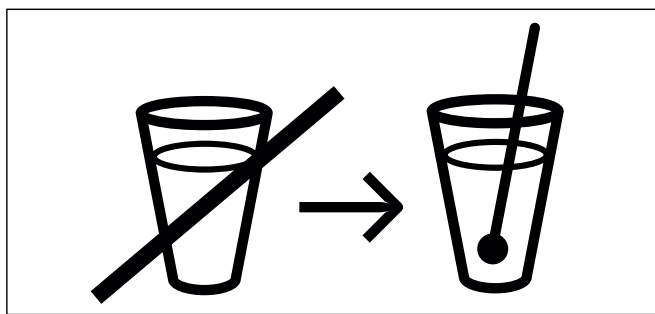

### AVERTISSEMENT

#### Risque de brûlure

Un retard d'ébullition peut se produire lorsque vous chauffez des liquides. Cela signifie que la température d'ébullition est atteinte sans que les bulles de vapeur typiques remontent. À la moindre secousse ou vibration, le liquide chaud peut alors subitement déborder et jaillir. Lorsque vous chauffez des liquides, mettez toujours une tige d'ébullition/cuillère dans le récipient. Vous éviterez ainsi un retard d'ébullition.

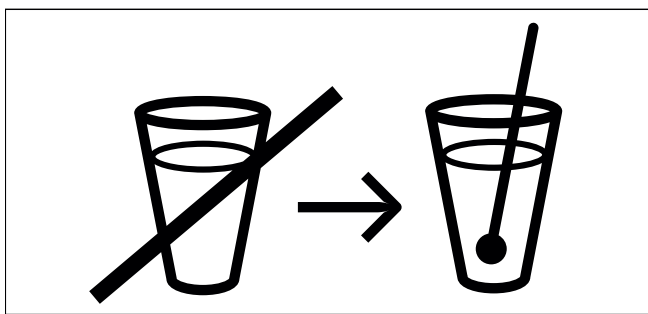

---

**⚠ CAUTION**

---

Metal e.g. a spoon in a glass must be kept at least 1" (25 mm) from the oven walls and the inside of the door. Sparks could irreparably damage the glass on the inside of the door.

---

---

**⚠ ATTENTION**

---

Du métal - par ex. une cuillère dans un verre - doit se trouver à une distance d'au moins 1 po (25 mm) des parois du four et de l'intérieur de porte. Des étincelles pourraient détériorer la vitre de la porte.

---

**Notes**

- Take ready meals out of the packaging. They will heat up more quickly and evenly in microwavable cookware. The different components of the meal may not require the same amount of time to heat up.
- Always cover the food. If you do not have a suitable cover for your container, use a plate or special microwave foil.
- Stir or turn the food several times during the heating time. Check the temperature.
- After heating, allow the food to stand for an additional 2 to 5 minutes to allow the temperature to even out.
- Always use an oven cloth or oven gloves when removing plates from the appliance.

**Note:** Place the cookware on the cooking compartment floor.

Heating food	Weight	Microwave output in watts, cooking time in minutes	Notes
Menu, plated meal, ready meal (2-3 components)	12.3 - 17.6 oz (350-500 g)	600 W, 4-8 min.	Covered
Beverages	0.32 pt (150 ml)	1000 W, 1-2 min.	Always place a glass rod/spoon in the container. Do not overheat alcoholic drinks; check occasionally while heating.
	0.62 pt (300 ml)	1000 W, 2-3 min.	
	1.1 pt (500 ml)	1000 W, 4-5 min.	
Baby food, e.g. baby bottles	0.11 pt (50 ml)	360 W, ½-1 min.	No nipples or lids. Always shake well after heating. You must check the temperature!
	0.21 pt (100 ml)	360 W, ½-1½ min.	
	0.63 pt (200 ml)	360 W, 1-2 min.	
Soup 1 cup	6.2 oz (175 g) each	600 W, 2-3 min.	-
Soup, 2 cups	6.2 oz (175 g) each	600 W, 3-4 min.	-
Soup, 4 cups	6.2 oz (175 g) each	600 W, 6-8 min.	-
Meat or pieces of meat in sauce	17.6 oz (500 g)	600 W, 8-11 min.	Covered
Stew	14.1 oz (400 g)	600 W, 6-8 min.	Cookware with lid
	28.2 oz (800 g)	600 W, 8-11 min.	
Vegetables, 1 portion	5.3 oz (150 g)	600 W, 2-3 min.	Add a little liquid
Vegetables, 2 portions	10.6 oz (300 g)	600 W, 3-5 min.	

## Cooking food

Food that lies flat will cook more quickly than food that is piled high. You should therefore distribute the food so that it is as flat as possible in the cookware. Food should not be placed in layers on top of one another.

Cook the food in cookware with a lid. It should be turned or stirred occasionally.

This will help the food retain its own distinct taste, so it will require less seasoning.

After heating, allow the food to stand for an additional 2 to 5 minutes to allow the temperature to even out.

**Note:** Place the cookware on the cooking compartment floor.

Dish	Amount	Microwave power in watts, cooking time in minutes	Notes
Whole chicken, fresh, no giblets	2.6 lb (1200 g)	600 W, 25 - 30 min.	Turn halfway through the cooking time.
Fish fillet, fresh	14.1 lb (400 g)	600 W, 7 - 12 min.	
Fresh vegetables	8.8 oz (250 g)	600 W, 6 - 10 min.	Cut the vegetables into pieces of equal size. Add 1 to 2 tbsp water per 3.5 oz (100 g) of vegetables, stir.
	17.6 oz (500 g)	600 W, 10 - 15 min.	
Side dishes, Potatoes	8.8 oz (250 g)	600 W, 8 - 10 min.	Cut the potatoes into pieces of equal size. Add 1 tbsp water per 3.5 oz (100 g) of vegetables, stir.
	17.6 oz (500 g)	600 W, 12 - 15 min.	
	26.5 oz (750 g)	600 W, 15 - 22 min.	
Rice	4.4 oz (125 g)	600 W, 4 - 6 min. + 180 W 12 - 15 min.	Add double the amount of liquid.
	8.8 oz (250 g)	600 W, 6 - 8 min. + 180 W 15 - 18 min.	
Sweet foods, e.g. pudding (instant)	1.1 pt (500 ml)	600 W, 6 - 8 min.	Stir the pudding thoroughly 2 to 3 times using an egg whisk while heating.
Fruit, compote	17.6 oz (500 g)	600 W, 9 - 12 min.	Stir while heating.

## Microwave tips

### CAUTION

Do not leave oven unattended while popping corn. Popcorn may ignite and cause fire.

### ATTENTION

Ne laissez pas le four sans surveillance lorsque vous faites éclater le popcorn. Le popcorn pourrait s'enflammer et provoquer un incendie.

<b>You cannot find any information about the settings for the quantity of food you have prepared.</b>	Lengthen or shorten the cooking time according to the following rule of thumb: Double the amount = double the time, half the amount = half the time
<b>The food has become too dry.</b>	Next time, set a shorter cooking time or select a lower microwave power setting. Cover the food and add more liquid.
<b>The time has elapsed but the food is not defrosted, hot or cooked.</b>	Set a longer time. Large quantities and food that is piled high require longer times.
<b>Time has elapsed but the food is overheated at the edge but not done in the middle.</b>	Stir it during the cooking time and next time, select a lower microwave power setting and a longer cooking time.
<b>After defrosting, the poultry or meat is defrosted on the outside but not defrosted in the middle.</b>	Next time, select a lower microwave output setting. If you are defrosting a large quantity, turn it several times.

## Cakes and pastries

**Baking tins:** It is best to use dark-colored metal baking tins.

When using the microwave, use baking containers made of glass, ceramic or plastic. These must be heat-resistant up to 480° F (250°C). Cakes will not brown so well if you use these types of baking containers.

**Tables:** The times given apply to food placed in a cold oven.

The temperature and baking time depend on the consistency and amount of the mixture. This is why temperature ranges are given in the tables. Begin with the lowest temperature and, if necessary, use a higher setting the next time. A lower temperature results in more even browning.

More information can be found in the “**Baking tips**” section that follows the tables.

Always place the cake pan in the center of the wire rack.

Cake	Cookware	Height	Type of heating	Temperature °F (°C)	Cooking time in minutes
Sponge cake, simple	Ring-shaped cake pan/Vienna ring	1	✚	320 - 340 (160-170)	60-80
Sponge cake, delicate (e.g. sandcake)	pan/cake pan	1		300 - 320 (150-160)	60-70
Cake base with edge of short-crust pastry	Springform cake pan	1	✚	320 - 340 (160-170)	35-45
Sponge cake base	Fruit sponge cake pan	1	✚	320 - 340 (160-170)	35-45
Hot water sponge cake	Springform cake pan	1	✚	340 - 355 (170-180)	45-50
Cake with dry topping (sponge)	Glass tray	2	✚	320 - 340 (160-170)	35-50
Cake with moist topping, e.g. yeast dough with apple crumble	Glass tray	2	✚	310 - 330 (155-165)	55-65
Plaited loaf with 17.6 oz (500 g) flour	Glass tray	2	✚	320 - 340 (160-170)	30-40

\* Allow cake to cool in the oven for approx. 20 minutes.

\*\* Never pour water directly into a hot oven.

Cake	Cookware	Height	Type of heating	Temperature °F (°C)	Cooking time in minutes
Stollen with 17.6 oz (500 g) flour	Glass tray	2	✦	340 - 355 (170-180)	60-70
Pizza	Glass tray	2	✦	390 - 410 (200-210)	30-40
Yeast bread 2.2 lb (1 kg)**	Glass tray	2	✦	355 - 375 (180-190)	50-60

\* Allow cake to cool in the oven for approx. 20 minutes.

\*\* Never pour water directly into a hot oven.

Cake	Cookware	Height	Microwave power setting in watts	Cooking time in minutes	Type of heating	Temperature °F (°C)
Nut cake	Springform cake pan	1	90 W	30-35	✦	340 - 355 (170-180)
Fruit tart or cheesecake with pastry*	Springform cake pan	2	360 W	40-50	✦	300 - 320 (150-160)
Fruit pie, delicate with sponge	Ring cake pan or springform cake pan	1	90 W	30-45	✦	340 - 375 (170-190)
Savory cakes (e.g. quiche/onion tart)	Springform cake pan or quiche pan	2	90 W	50-70	✦	320 - 355 (160-180)

\* Allow cake to cool in the oven for approx. 20 minutes.

Small baked products	Cookware	Height	Type of heating	Temperature °F (°C)	Cooking time in minutes
Cookies	Glass tray	2	✦	300 - 340 (150-170)	20-35
Meringue	Glass tray	2	✦	230 (110)	90-120
Macaroons	Glass tray	2	✦	230 (110)	35-45
Puff pastry	Glass tray	2	✦	355 - 390 (180-200)	35-45
Bread rolls (e.g. rye bread rolls)	Glass tray	2	✦	355 - 390 (180-200)	25-45

## Baking tips

<b>You want to bake according to your own recipe.</b>	Use similar items in the baking tables as a guide.
<b>How to tell whether sponge cake is baked through.</b>	Approximately 10 minutes before the end of the baking time specified in the recipe, poke the cake with a toothpick at its highest point. If the toothpick comes out clean, the cake is ready.
<b>The cake collapses.</b>	Use less fluid next time or set the oven temperature 10 degrees lower. Observe the specified mixing times in the recipe.
<b>The cake has risen in the middle but is lower around the edge.</b>	Only grease the base of the springform cake pan. After baking, loosen the cake carefully with a knife.
<b>The cake is too dark.</b>	Select a lower temperature and bake the cake for a little longer.
<b>The cake is too dry.</b>	Make tiny holes in the finished cake using a toothpick. Then drizzle fruit juice or an alcoholic beverage over it. Next time, select a temperature 10 degrees higher and reduce the baking time.
<b>The bread or cake (e.g. cheesecake) looks good, but is soggy on the inside (sticky, with streaks of water).</b>	Use slightly less fluid next time and bake for slightly longer at a lower temperature. When baking cakes with a moist topping, bake the base first, cover with almonds or bread crumbs and then add the topping. Please follow the recipe and follow the baking times.

<b>The cake cannot be turned out of the dish when it is turned upside down.</b>	Let the cake cool for 5 to 10 minutes after baking; then it will be easier to turn out of the pan. If it still does not turn out, carefully loosen it around the edges with a knife. Turn the cake pan upside down again and cover it several times with a cold, wet cloth. Next time, grease the pan well and sprinkle some bread crumbs into it.
<b>You have measured the temperature of the oven using your own meat thermometer and found there is a discrepancy.</b>	The oven temperature is measured by the manufacturer after a specified period of time using a test rack in the center of the cooking compartment. Cookware and accessories affect the temperature measurement, so there will always be some discrepancy when you measure the temperature yourself.
<b>Sparks are generated between the pan and the wire rack.</b>	Check that the pan is clean on the outside. Change the position of the pan in the cooking compartment. If this does not help, continue baking without microwave or use the glass tray as a surface. The baking time will then be longer.

## Roasting and grilling

**Tables:** The times given apply to food placed in a cold oven.

The temperature and roasting time depend on the type and amount of food being cooked. This is why temperature ranges are given in the tables. Begin with the lowest temperature and, if necessary, use a higher setting the next time.

For more information, see the section entitled "**Tips for grilling and roasting**" that follows the tables.

**Cookware:** You may use any heat-resistant cookware that is suitable for use in a microwave. Metal roasting dishes are only suitable for roasting without microwaves.

The cookware can become very hot. Use oven gloves to take the cookware out of the oven.

Place hot glass cookware on a dry kitchen towel after it has been removed from the oven. The glass could crack if placed on a cold or wet surface.

**Tips for roasting:** Use a deep roasting dish for roasting meat and poultry.

Check that your cookware fits in the cooking compartment. It should not be too big.

**Meat:** Cover the bottom of the cookware with liquid. Add slightly more liquid for pot roasts. Turn pieces of meat halfway through the cooking time. When the roast is ready, turn off the oven and allow it to rest for an additional 10 minutes. This allows better distribution of the meat juices.

**Grilling tip:** Always keep the oven door closed when grilling and do not preheat.

As far as possible, the pieces of food you are grilling should be of equal thickness. Steaks should be at least 1 inch (25 mm) thick. This will allow them to brown evenly and remain succulent and juicy. Only add salt to steaks once they have been grilled.













Use tongs to turn the pieces of food you are grilling. If you pierce the meat with a fork, the juices will run out and it will become dry.

Dark meat, such as beef, browns more quickly than lighter-colored meat, such as veal or pork. When grilling light-colored meat or fish, these often only brown slightly on the surface, although they are cooked and juicy on the inside.

The grill element switches off and on again automatically. This is normal. The grill setting determines how frequently this occurs.

**Steaming tips:** Use cookware with a lid for braising fish.

Put two to three tablespoons of liquid and a little lemon juice or vinegar into the cookware.

Dish	Amount	Microwave power setting in watts, cooking time in minutes	Height	Type of heating	Temperature °F (°C), grill setting	Notes
Pot-roasted beef	Approx. 2.2 lb (1000 g)	180 W, 80-90 min.	0		320 - 340 (160-170)	Cookware with lid
Steak, medium rare	Approx. 2.2 lb (1000 g)	180 W, 30-40 min.	0		355 - 390 (180-200)	Cookware without lid. Turn halfway through the cooking time.
Pork roast without (e.g. neck)	Approx. 26.5 oz (750 g)	360 W, 35-45 min.	0		340 - 355 (170-180)	Cookware without lid.
Boned pork with rind* (e.g. shoulder)	Approx. 2.2 lb (1000 g)	180 W, 80-90 min.	0		340 - 355 (170-180)	Cookware without lid. Do not turn.
Pork tenderloin	Approx. 17.6 - 21.2 oz (500-600 g)	180 W, 35-40 min.	0		355 - 375 (180-190)	Cookware without lid.
Meat loaf	Approx. 26.5 oz (750 g)	360 W, 30-35 min.	0		390 - 410 (200-210)	Cookware without lid.
Chicken, whole	Approx. 2.2 - 2.6 lb (1000-1200 g)	360 W, 30-40 min.	0		355 - 375 (180-190)	Cookware with lid. Place with the breast side up. Do not turn.
Chicken portions, e.g. chicken quarters	Approx. 28.2 oz (800 g)	360 W, 20-30 min.	0		355 - 375 (180-190)	Cookware without lid. Place with the skin side up. Do not turn.
Duck	Approx. 3.3 - 3.7 lb (1500-1700 g)	180 W, 70-80 min.	0		445 - 480 (230-250)	Cookware with lid. Do not turn.
Duck breast Duck breast, 2 pieces	Approx. 17.6 oz (500 g)  8.8 - 10.6 oz (250-300 g) each	180 W, 15-20 min.	0		3	Cookware without lid. Place with the skin side up. Do not turn.
Turkey breast, turkey legs	24.7 - 31.7 oz (700-900 g)	180 W, 30-40 min.	0		2	Deep cookware without lid. Do not turn.
Fish, grilled	Approx. 17.6 oz (500 g)	600 W, 10-15 min.	0		3	Cookware without lid. Defrost frozen fish before cooking.

\* Make cuts in the pork rind.



Dish	Amount	Weight	Height	Type of heating	Grill setting	Cooking time in minutes
Steaks, ca. 1 in (25 mm) thick	2 - 3 pieces	approx. 7.1 oz (200 g) each	1+3**	~~~~~	3 3	1st side: approx. 10 - 15 2nd side: approx. 5 - 10
Grilled sausages	4 - 6 pieces	approx. 5.3 oz (150 g) each	1+3**	~~~~~	3 3	1st side: approx. 10 - 15 2nd side: approx. 5 - 10
Fish steak*	2 - 3 pieces	approx. 5.3 oz (150 g) each	1+3**	~~~~~	3 3	1st side: approx. 10 - 12 2nd side: approx. 8 - 12
Fish fillet*	2 - 3 pieces	approx. 10.6 oz (300 g) each	1+3**	~~~~~	3 3	1st side: approx. 10 - 15 2nd side: approx. 10 - 15
Toast	12 slices	-	3	~~~~~	3 3	1st side: approx. 3 - 5 2nd side: approx. 2 - 3
Toast with topping	2-4 slices***	-	1+3**	~~~~~	3	Depending on topping: 8-10

\* Grease the wire rack first with oil.

\*\* Slide the wire rack in at level 3 and the glass tray at level 1.

\*\*\* Toast the slices of bread in advance

## Tips for roasting and grilling

<b>The table does not contain information for the weight of the roast.</b>	For small roasts, select a higher temperature and a shorter cooking time. For larger roasts, select a lower temperature and a longer cooking time.
<b>This is how you can tell when the roast is ready.</b>	Use a meat thermometer (available from specialist shops) or carry out a "spoon test." Press down on the roast with a spoon. If it feels firm, it is ready. If the spoon can be pressed in, it needs to be cooked for a little longer.
<b>The roast looks good but the juices are burnt.</b>	Next time, use a smaller roasting dish or add more liquid.
<b>The roast looks good but the juices are too clear and watery.</b>	Next time, use a larger roasting dish and add less liquid.
<b>The roast is not well-done enough.</b>	Carve the roast. Prepare the gravy in the roasting dish and place the slices of roast meat in the gravy. Finish cooking the meat using the microwave only.



## Casseroles, gratins

The table applies to dishes placed in a cold oven.

Place the casserole in microwaveable cookware on the cooking compartment floor.

Use large shallow cookware for casseroles and gratins. Food takes longer to cook in narrow, deep containers and browns more on top.







Casseroles and gratins should be left to cook in the oven for an additional 5 minutes after the oven has been switched off.

Dish	Amount	Cookware	Height	Microwave watts	Cooking time in minutes	Type of heating	Temperature °F (°C)
Casseroles, sweet, e.g. quark soufflé with fruit	Approx. 3.3 lb (1500 g)	Flat ovenproof dish ca. 2 in (50 mm) height, e.g. tart pan	0	180 W	25-35		265 - 300 (130-150)
Savory casseroles made from cooked ingredients (e.g. pasta bake)	Approx. 2.2 lb (1000 g)	Flat ovenproof dish ca. 2 in (50 mm) height, e.g. 9 in x13 in casserole	0	600 W	20-30		320 - 375 (160-190)
Savory casseroles made from raw ingredients (e.g. potato gratin)	Approx. 2.4 lb (1100 g)	Flat ovenproof dish ca. 2 in (50 mm) height, e.g. 9 in x13 in casserole	0	600 W	25-35		340 - 355 (170-180)

## Frozen convenience products

Observe the instructions on the packaging.

The values in the table apply to food placed in a cold oven.

Dish	Cookware	Height	Type of heating	Temperature °F (°C)	Cooking time in minutes
Strudel with fruit filling*	Glass tray	2		390 - 430 (200-220)	40-50
French fries	Glass tray	2		410 - 445 (210-230)	20-30
Pizza	Wire rack	2		355 - 390 (180-200)	10-20
Pizza baguette	Wire rack	2		320 - 375 (160-190)	15-20
Croquettes	Glass tray	2		390 - 430 (200-220)	20-30
Rösti	Glass tray	2		390 - 430 (200-220)	20-30

\* Preheat the oven for 5 minutes.

## Test dishes

The quality and function of microwave combination appliances are tested by testing institutes using the following dishes.

In accordance with EN 60705, IEC 60705, DIN 44547, and EN 60350



### Microwave defrosting

Dish	Microwave power in watts, cooking time in minutes	Notes
Meat, 17.6 oz (500 g)	180 W, 7 min. +90 W, 8-12 min. or "Defrost Hamburger meat" program	Place Pyrex dish with a diameter of 9 in (230 mm) on the oven floor.

### Microwave cooking

Dish	Microwave power in watts, cooking time in minutes	Notes
Custard, 35.3 oz (1000 g)	600 W, 11-12 min. + 180 W, 15-20 min.	Place Pyrex dish on the oven floor.
Sponge, 16.8 oz (475 g)	600 W, 8-10 min.	Place Pyrex dish with a diameter of 9 in (230 mm) on the oven floor.
Meat loaf, 31.7 oz (900 g)	600 W, 25-30 min.	Place Pyrex dish on the oven floor.





### Combined microwave cooking

Dish	Microwave power in watts, cooking time in minutes	Type of heating	Temperature in °F (°C), grill setting	Notes
Potato gratin	360 W, 30-35 min.		1	Place Pyrex dish with a diameter of 9 in (230 mm) on the oven floor.
Cake	180 W, 20-25 min.		375 - 390 (190-200)	Place Pyrex dish with a diameter of 9 in (230 mm) on the wire rack, on level 1.
Chicken	360 W, 30-35 min.		465 (240)	Put the chicken breast-side down in deep cookware without a lid and place on the cooking compartment floor. Turn halfway through the cooking time.

In accordance with DIN 44547 and EN 60350

### Baking

The values in the table apply to food placed in a cold oven.

Dish	Notes regarding cookware	Height	Type of heating	Temperature °F (°C)	Baking time in minutes
Piped cookies	Glass tray	2		320 - 340 (160-170)	30-35
Small cakes*	Glass tray	2		320 - 340 (160-170)	25-30
Hot water sponge cake	Springform cake pan on the wire rack	1		340 - 355 (170-180)	45-50
Yeast sheet cake	Glass tray	2		320 - 355 (160-180)	50-60

Dish	Notes regarding cookware	Height	Type of heating	Temperature °F (°C)	Baking time in minutes
Double crust apple pie	Dark springform cake pan directly on the wire rack	2	✚	340 - 375 (170-190)	80-100

\* Preheat the oven for 5 minutes.

## Grilling

The values in the table apply to food placed in a cold oven.

Dish	Accessories	Height	Grill <sup>www</sup>	Cooking time in minutes
Browning toast	Wire rack	3	3	4-5
Beef burgers, x 12*	Wire rack and glass tray	3+1	3	30-35

\* turn over after ½ of the cooking time.

## Acrylamide in foodstuffs

Which foods are affected?

Acrylamide is mainly produced in grain and potato products that are heated to high temperatures, such as potato chips, french fries, toast, bread rolls, bread, fine baked goods (cookies, gingerbread, Spekulatius).

<b>Tips for keeping acrylamide to a minimum when preparing food</b>	
General	Keep cooking times to a minimum. Cook meals until they are golden brown, but not too dark. Large, thick pieces of food contain less acrylamide.
Baking	With Convection max. 355°F (180°C).
Cookies	Egg or egg yolk reduces the production of acrylamide. Spread out a single layer evenly on the glass tray.
Oven fries	Cook at least 14.1 oz (400 g) at once on a glass tray so that the fries do not dry out.







BSH Home Appliance Corporation  
1901 Main Street, Suite 600  
Irvine, CA 92614 +1.877.442.4436  
USA  
[www.gaggenau-usa.com](http://www.gaggenau-usa.com)  
© 2024 BSH Home Appliances



900128704

1 (040620) en-us

**GAGGENAU**