

SIEMENS



Free standing cooker

HG211TQ50M

siemens-home.bsh-group.com/welcome

[en] Instruction manual

Register
your
product
online

en Table of contents

Important safety information	4
Causes of damage	7
Hob	7
Damage to the oven.....	7
Storage compartment	7
Measures to be noted during transport	7
If the original packaging is no longer available	7
Installation	8
Fitting the adjustable feet	8
Positioning and levelling	8
Positioning the appliance	8
Aligning the appliance	8
Adjacent units.....	8
Wall fixing	8
Gas connection	9
For the licensed expert or after-sales service	9
Flexible hoses.....	9
Checking for leaks.....	9
Initial use.....	9
Faults in the gas installation/smell of gas	9
Moving the appliance by the gas line or door handle.....	9
Electrical connection	10
Energy and environment tips	10
Saving energy.....	10
Saving energy with the gas hob	10
Environmentally-friendly disposal.....	10
Your new appliance	11
The control panel.....	11
The timer.....	11
The hob.....	12
Oven	13
The cooking compartment.....	13
The storage compartment.....	13
Accessories	14
Before using for the first time	14
Baking out the oven	14
Cleaning the burner caps and cups	14
Cleaning the accessories.....	14
Operating the appliance	15
Hob	15
Oven	15
Using combi mode	16
Rotary spit	16
Care and cleaning	18
Cleaning agents	18
Keeping the appliance clean.....	19
Appliance door	20
Detaching and attaching the oven door.....	20
Trouble shooting	21
Replacing the oven light bulb.....	21
After-sales service	22
E number and FD number	22

Additional information on products, accessories, replacement parts and services can be found at www.siemens-home.bsh-group.com and in the online shop www.siemens-home.bsh-group.com/eshops

Important safety information

Read these instructions carefully. Only then will you be able to operate your appliance safely and correctly. Retain the instruction manual and installation instructions for future use or for subsequent owners.

These instructions are only valid if the appropriate country symbol appears on the appliance. If the symbol does not appear on the appliance, it is necessary to refer to the technical instructions which will provide the necessary instructions concerning modification of the appliance to the conditions of use of the country.

Check the appliance for damage after unpacking it. Do not connect the appliance if it has been damaged in transport.

Only allow a licensed professional to connect the appliance and to convert the appliance to a different type of gas. The appliance must be installed (electric and gas connections) in accordance with the instruction and installation manual. An incorrect connection or incorrect settings may lead to serious accidents and damage to the appliance. The appliance manufacturer accepts no liability for damage of this kind. The appliance's warranty becomes void.

This appliance is intended for domestic use and the household environment only. This appliance must only be used to prepare food and drinks and must never be used as a heater. Do not leave the appliance unattended during operation. Only use the appliance indoors.

This appliance is intended for use up to a maximum height of 2000 metres above sea level.

Caution: The use of a gas cooking appliance results in the production of heat, moisture and products of combustion in the room in which it is installed. Ensure that the kitchen is well ventilated especially when the appliance is in use: keep natural ventilation holes open or install a mechanical ventilation device (mechanical extractor hood).

Prolonged intensive use of the appliance may call for additional ventilation, for example opening of a window, or more effective ventilation, for example increasing the level of mechanical ventilation where present.

This appliance is not designed for operation with an external timer or by remote control. Do not use inappropriate child safety shields or hob guards. These can cause accidents.

This appliance may be used by children over the age of 8 years old and by persons with reduced physical, sensory or mental capabilities or by persons with a lack of experience or knowledge if they are supervised or are instructed by a person responsible for their safety how to use the appliance safely and have understood the associated hazards.

Children must not play with, on, or around the appliance. Children must not clean the appliance or carry out general maintenance unless they are at least 15 years old and are being supervised.

Keep children below the age of 8 years old at a safe distance from the appliance and power cable.

Always slide accessories into the cooking compartment correctly. See "*Description of accessories*" in the instruction manual.

Close the safety valve on the gas supply line if the cooker will not be used for a prolonged period.

Risk of fire!

- A draught is created when the appliance door is opened. Greaseproof paper may come into contact with the heating element and catch fire. Do not place greaseproof paper loosely over accessories during preheating. Always weight down the greaseproof paper with a dish or a baking tin. Only cover the surface required with greaseproof paper. Greaseproof paper must not protrude over the accessories.
- Combustible objects that are left in the cooking compartment may ignite. Never store combustible items in the cooking compartment. Never open the appliance door if there is smoke inside. Switch off the appliance and unplug the mains plug or switch off the fuse in the fuse box. Shut off the gas supply.

- Hot oil and fat can ignite very quickly. Never leave hot fat or oil unattended. Never use water to put out burning oil or fat. Switch off the hotplate. Extinguish flames carefully using a lid, fire blanket or something similar.
- The hotplates become very hot. Never place combustible items on the hob. Never place objects on the hob.
- The appliance becomes very hot, and flammable materials can easily catch fire. Do not store or use any flammable objects (e.g. aerosol cans, cleaning agents) under or in the vicinity of the oven. Do not store any flammable objects inside or on top of the oven.
- When gas hotplates are in operation without any cookware placed on them, they can build up a lot of heat. The appliance and the extractor hood above it may become damaged or be set on fire. Grease residue in the filter of the extractor hood may ignite. Only operate the gas burners with cookware on them.
- The rear of the appliance becomes very hot. This may cause damage to the power cables. Electricity and gas lines must not come into contact with the rear of the appliance.
- Never place flammable objects on the burners or store them in the cooking compartment. Never open the appliance door if there is smoke inside. Switch off the appliance. Pull out the mains plug or switch off the appliance at the circuit breaker in the fuse box. Shut off the gas supply.
- The surfaces of the plinth drawer may become very hot. Only store oven accessories in the drawer. Flammable and combustible objects must not be stored in the plinth drawer.
- Alcoholic vapours may catch fire in the hot cooking compartment. Never prepare food containing large quantities of drinks with a high alcohol content. Only use small quantities of drinks with a high alcohol content. Open the appliance door with care.
- The hotplates and surrounding area (particularly the hob surround, if fitted) become very hot. Never touch the hot surfaces. Keep children at a safe distance.
- During operation, the surfaces of the appliance become hot. Do not touch the surfaces when they are hot. Keep children away from the appliance.
- Empty cookware becomes extremely hot when set on a gas hotplate that is in operation. Never heat up empty cookware.
- The appliance becomes hot during operation. Allow the appliance to cool down before cleaning.
- **Caution:** Accessible parts may be hot when the grill is in use. Young children should be kept away from the appliance.
- If the liquefied gas bottle is not upright, liquefied propane/butane can enter the appliance. Intense darting flames may therefore escape from the burners. Components may become damaged and start to leak over time so that gas escapes uncontrollably. Both can cause burns. Always use liquefied gas bottles in an upright position.

Risk of scalding!

Risk of burns!

- The accessible parts become hot during operation. Never touch the hot parts. Keep children at a safe distance.
- When you open the appliance door, hot steam may escape. Open the appliance door with care. Keep children at a safe distance.
- Water in a hot cooking compartment may create hot steam. Never pour water into the hot cooking compartment.
- The appliance becomes very hot. Never touch the interior surfaces of the cooking compartment or the heating elements. Always allow the appliance to cool down. Keep children at a safe distance.
- Accessories and ovenware become very hot. Always use oven gloves to remove accessories or ovenware from the cooking compartment.

Risk of injury!

- Scratched glass in the appliance door may develop into a crack. Do not use a glass scraper, sharp or abrasive cleaning aids or detergents.
- Incorrect repairs are dangerous. Repairs may only be carried out, and damaged power and gas lines replaced, by an after-sales engineer trained by us. If the appliance is faulty, unplug the mains plug or switch off the fuse in the fuse box. Shut off the gas supply. Contact the after-sales service.
- Faults or damage to the appliance are dangerous. Never switch on a faulty appliance. Unplug the appliance from the mains or switch off the circuit breaker in the fuse box. Shut off the gas supply. Contact the after-sales service.
- Unsuitable pan sizes, damaged or incorrectly positioned pans can cause serious injury. Observe the instructions which accompany the cookware.
- **Caution:** Glass lids may shatter when heated. Turn off all the burners before shutting the lid. Wait until the oven has cooled down before closing the glass cover.

Before opening the top cover, remove any spills with a cloth.



- If the appliance is placed on a base and is not secured, it may slide off the base. The appliance must be fixed to the base.
- The hinges on the appliance door move when opening and closing the door, and you may be trapped. Keep your hands away from the hinges.

Risk of tipping!

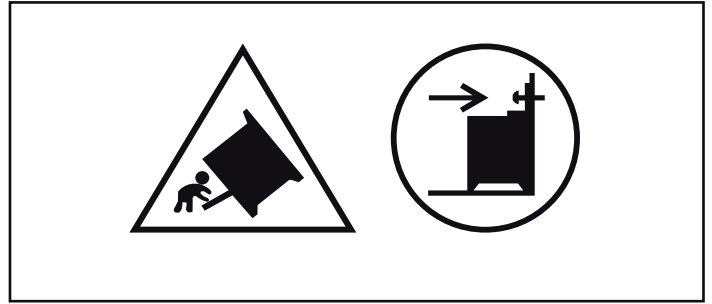

Warning: In order to prevent tipping of the appliance, this stabilizing means must be installed. Refer to the instructions for installation.

Risk of electric shock!

- Incorrect repairs are dangerous. Repairs may only be carried out by one of our trained after-sales engineers. If the appliance is faulty, unplug the mains plug or switch off the fuse in the fuse box. Contact the after-sales service.
- The cable insulation on electrical appliances may melt when touching hot parts of the appliance. Never bring electrical appliance cables into contact with hot parts of the appliance.
- Do not use any high-pressure cleaners or steam cleaners, which can result in an electric shock.
- When replacing the cooking compartment bulb, the bulb socket contacts are live. Before replacing the bulb, unplug the appliance from the mains or switch off the circuit breaker in the fuse box.
- A defective appliance may cause electric shock. Never switch on a defective appliance. Unplug the appliance from the mains or switch off the circuit breaker in the fuse box. Contact the after-sales service.

Causes of damage

Hob

Caution!

- Only use the burners when cookware has been placed on top. Do not heat up empty pots or pans. The saucepan base will be damaged.
- Only use pots and pans with an even base.
- Place the pot or pan centrally over the burner. This will optimise transfer of the heat from the burner flame to the pot or pan base. The handle does not become damaged, and greater energy savings are guaranteed.
- Clear up spills immediately. Use deep pots for dishes with a lot of liquid. This will prevent the food from boiling over.
- Do not use roasting dishes if they must be heated using two burners. This will cause heat accumulation. The appliance could be damaged.
- Cooking on gas burners releases extra heat and moisture. Adjacent units may become damaged over time. For long cooking times, switch on the cooker hood or ventilate the room.
- Observe the manufacturer's instructions when using special ovenware. Aluminium foil and plastic containers can melt and stick on hot burners.
- Ensure that the gas burners are clean and dry. The burner cup and burner cap must be positioned exactly.
- Ensure that the top cover is not closed when the oven is started up.

Damage to the oven

Caution!

- Accessories, foil, greaseproof paper or ovenware on the cooking compartment floor: do not place accessories on the cooking compartment floor. Do not cover the cooking compartment floor with any sort of foil or greaseproof paper. Do not place ovenware on the cooking compartment floor if a temperature of over 50 °C has been set. This will cause heat to accumulate. The baking and roasting times will no longer be correct and the enamel will be damaged.

- Water in a hot cooking compartment: do not pour water into the cooking compartment when it is hot. This will cause steam. The temperature change can cause damage to the enamel.
- Moist food: do not store moist food in the cooking compartment when it is closed for prolonged periods. This will damage the enamel.
- Fruit juice: when baking particularly juicy fruit pies, do not pack the baking tray too generously. Fruit juice dripping from the baking tray leaves stains that cannot be removed. If possible, use the deeper universal pan.
- Cooling with the appliance door open: only allow the cooking compartment to cool when it is closed. Even if the appliance door is only open a little, front panels of adjacent units could be damaged over time.
- Very dirty door seal: If the door seal is very dirty, the appliance door will no longer close properly when the appliance is in use. The fronts of adjacent units could be damaged. Always keep the door seal clean.
- Appliance door as a seat, shelf or worktop: Do not sit on the appliance door, or place or hang anything on it. Do not place any cookware or accessories on the appliance door.
- Inserting accessories: depending on the appliance model, accessories can scratch the door panel when closing the appliance door. Always insert the accessories into the cooking compartment as far as they will go.
- Carrying the appliance: do not carry or hold the appliance by the door handle. The door handle cannot support the weight of the appliance and could break.
- Heavy accessories: do not pull out heavily laden accessories too far without first unloading them sufficiently. Heavy accessories will tip when pulled out. This causes pressure to be exerted on the shelf supports in the cooking compartment, which can damage the enamel. Relieve the strain on the accessories when they are pulled out by raising them slightly with one hand. Caution: always use an oven cloth or oven gloves when handling hot accessories.

Storage compartment

Caution!

Do not place hot objects in the storage compartment. It could be damaged.

Measures to be noted during transport

Secure all mobile parts in and on the appliance using an adhesive tape that can be removed without leaving any traces. Push all accessories (e.g. baking tray) into the corresponding slots with cardboard at the edges, in order to avoid damaging the appliance. Place cardboard or similar between the front and rear side to prevent knocks against the inside of the glass door. Secure the door and, if available, the top cover to the appliance sides using adhesive tape.

Keep the original appliance packaging. Only transport the appliance in the original packaging. Observe the transport arrows on the packaging.

If the original packaging is no longer available

pack the appliance in protective packaging to guarantee sufficient protection against any transport damage.

Transport the appliance in an upright position. Do not hold the appliance by the door handle or the connections on the rear, as these could be damaged. Do not place any heavy objects on the appliance.

Installation

This appliance is supplied with a set of adjustable feet and a glass cover. The glass cover is prefitted.

Fitting the adjustable feet

1. Remove all parts that are not permanently fixed, especially the pan supports and burners.
2. Remove any accessories from the oven.
3. Lift one side of the appliance off the floor and tilt it slightly.

4. Screw the adjustable feet into the mounting holes on the underside of the appliance.

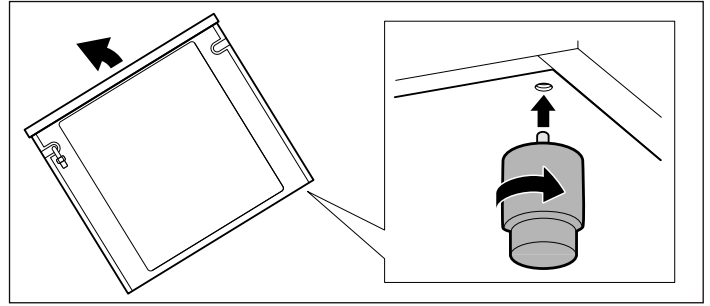

Note: If the appliance needs to be moved again, screw the adjustable feet in fully.

5. Only finally level the appliance once the electricity and gas have been connected and all of the installation work is complete.

Positioning and levelling

Positioning the appliance

When installing the appliance, make sure that there is enough space in the final installation location to pull the appliance forwards for cleaning and maintenance work.

The ground underneath must be hard and firm. The wall immediately behind the appliance must be made from non-flammable material, e.g. tiles.

If you need to move the appliance in order to position it, make sure that the adjustable feet are fully screwed in.

Aligning the appliance

Turn the adjustable feet to align the appliance.

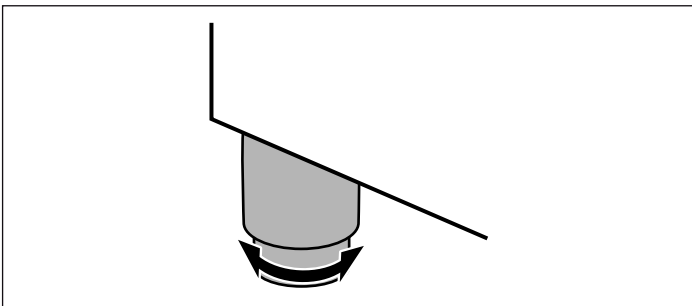

Note: Do not align the appliance until all other work has been completed.

The adjustable feet can be used to elevate the appliance by a maximum of 50 mm.

Check the alignment of the appliance once it has been installed in the intended place.

Adjacent units

Any adjacent units must not be made of flammable materials. The fronts of any adjacent units must be heat-resistant up to at least 90 °C. If the appliance is installed very close to any other units, the minimum clearances given in the figure must be maintained.

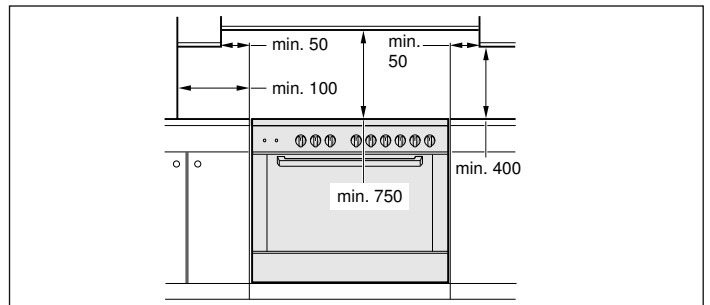

Wall fixing

To prevent the cooker from tipping over, you must fix it to the wall using the enclosed bracket. Please observe the installation instructions for fixing the oven to the wall.

Gas connection

Installation must only be performed by an approved expert or a licensed after-sales service engineer in accordance with the instructions specified under "Gas connection and conversion to a different gas type".

For the licensed expert or after-sales service

Caution!

- The settings for configuring this appliance can be found on the rating plate.
- Before setting up the appliance, check the grid access conditions (gas type and gas pressure) and ensure that the gas setting of the appliance meets these conditions. If the appliance settings have to be changed, follow the instructions in the section "Gas connection and conversion to a different gas type".
- This appliance is not connected to a waste gas main. It must be connected and commissioned in accordance with the installation conditions. Do not connect the appliance to a waste gas main. All ventilation regulations must be observed.
- The gas connection must be made via a fixed, i.e. not mobile connection (gas line) or via a safety hose.
- If using the safety hose, ensure that the hose is not trapped or crushed. The hose must not come into contact with hot surfaces.
- The connection must have an easily accessible locking device.

Flexible hoses

For flexible hoses, observe the following points:

- Do not pinch or squeeze hoses.
- Do not subject the hoses to twisting or pulling forces.
- Keep the hoses away from sharp edges.
- Do not let the hoses come into contact with parts that may reach a temperature higher than 70 °C above room temperature.
- Make sure that the full length of the hoses is accessible for inspection.

Checking for leaks

After connecting the gas line, check the connections for leaks using soapy water.

Initial use

Switch the appliance on as described in the instructions for use. Light all the burners and check that the flames remain stable at both the high and low settings.

Faults in the gas installation/smell of gas

If you notice a smell of gas or faults in the gas installation, you must

- immediately shut off the gas supply and/or close the gas cylinder valve
- immediately extinguish all naked flames and cigarettes
- switch off electrical appliances and lights
- open windows and ventilate the room
- call the after-sales service or the gas supplier

Moving the appliance by the gas line or door handle

Do not move the appliance while holding the gas line; the gas pipe could be damaged. There is a risk of a gas leak! Do not move the appliance while holding it by the door handle. The door hinges and door handle could be damaged.

Electrical connection

The appliance must only be connected to the mains electricity supply by specialist personnel. The appliance must be installed in accordance with the most recent IEE guidelines (Institute of Electrical Engineers). The appliance may be damaged if it is not connected correctly.

Make sure the voltage of the power supply matches the value specified on the rating plate.

Make sure that the power supply is properly earthed and that the fuse and the cable/wiring system in the building is sufficiently dimensioned for the electrical power of the appliance.

We recommend configuring the power circuit for the appliance to 16 A.

Always observe the following when laying the connection cable:

- Do not pinch or squeeze the cable.
- Keep the cable away from sharp edges.
- Do not allow the cable to come into contact with parts that can reach temperatures of over 50 °C above room temperature.

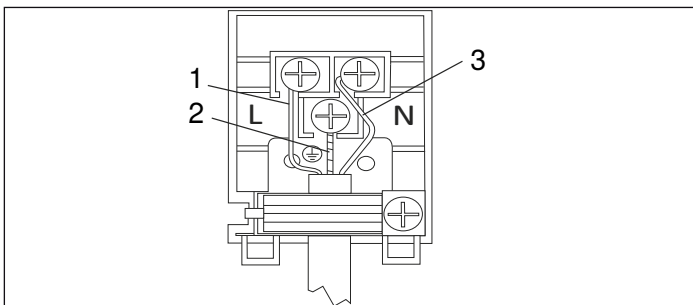

Explanatory notes

1	Brown
2	Green and yellow
3	Blue

⚠ Danger of death!

There is a risk of electric shock if you touch live components.

- Always make sure your hands are dry when you touch or hold the mains plug.
- Only pull out the mains cable by taking hold of the plug and removing the plug; never pull it out by the mains cable itself, as this could damage it.
- Never unplug the mains plug when the appliance is in operation.

Please note the following information and ensure that:

Notes

- The mains plug fits the socket.
- The cable cross section is adequate.
- The earthing system is properly installed.
- The mains cable is only replaced by a qualified electrician (if this is necessary). Spare mains cables can be ordered from our after-sales service.
- No power strips/multi-way connectors or extension cables are used.
- If using a residual current device, only use one that bears the mark . The presence of this mark is the only way to be sure that it fulfils all the applicable regulations.
- The mains plug can be accessed at all times.
- The mains cable is not kinked, crushed, modified or severed.
- The mains cable does not come into contact with heat sources.

Energy and environment tips

Here you can find tips on how to save energy when baking and roasting in the oven and when cooking on the hob, and how to dispose of your appliance properly.

Saving energy

- Only preheat the oven if this is specified in the recipe or in the tables in the instruction manual.
- Use dark, black lacquered or enamelled baking tins, because they absorb heat particularly well.
- Open the oven door as infrequently as possible while the food is baking and roasting.
- For longer cooking times, the oven can be turned off 10 minutes before the end of the cooking time, and the meal can be finished using residual heat.

Saving energy with the gas hob

- Always use a saucepan which is the correct size for your food. A larger, less full saucepan requires a lot of energy.
- Always place a suitable lid on the saucepan.
- The gas flame must always be in contact with the base of the saucepan.

Environmentally-friendly disposal

Dispose of packaging in an environmentally-friendly manner.



This appliance is labelled in accordance with European Directive 2012/19/EU concerning used electrical and electronic appliances (waste electrical and electronic equipment - WEEE). The guideline determines the framework for the return and recycling of used appliances as applicable throughout the EU.

Your new appliance

Get to know your appliance. You will find information about the control panel and hob, as well as the oven, types of heating and accessories.

Depending on the appliance model, individual details may differ.

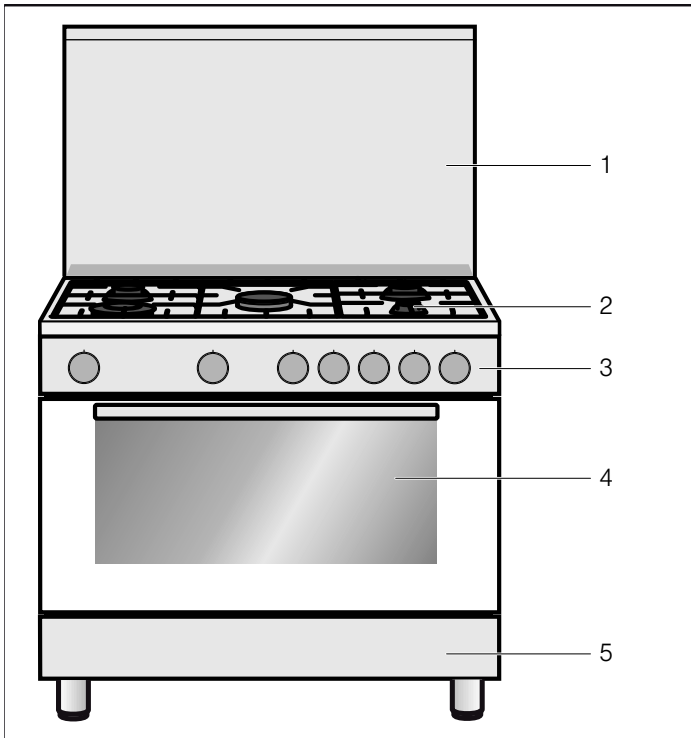

Explanation

1	Hob cover
2	Hob
3	Control panel
4	Oven
5	Storage compartment

The control panel

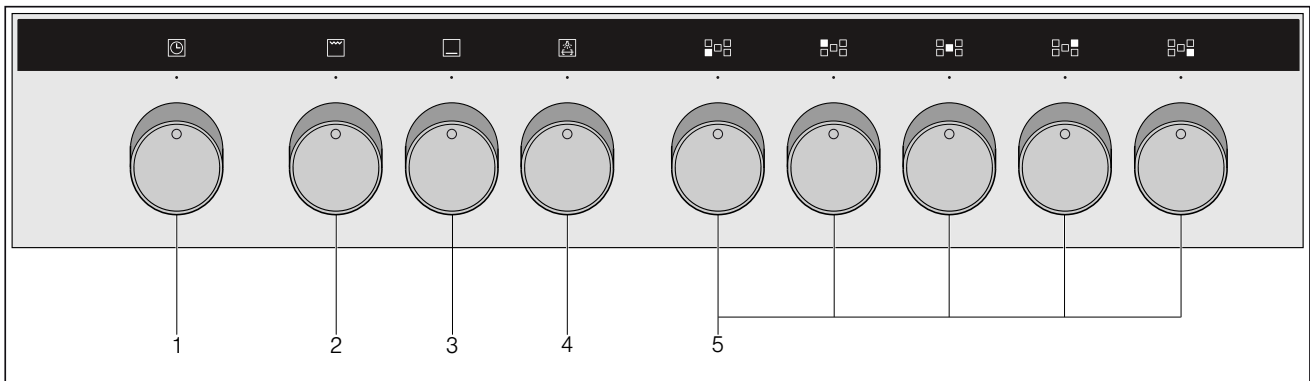

Description

1	Control knob for the timer
2	Control knob for the oven/gas grill
3	Control knob for the oven
4	Control knob for the oven light and rotisserie spit
5	Control knob for the gas burners

The timer

You can use the timer to set a cooking time.

An audible signal sounds once the cooking time has elapsed.

The timer runs independently of the oven. It can be used like a kitchen timer.

Control knob for the timer

Position	Meaning
●	Off
10 - 100	Cooking time in minutes

The hob

Risk of burns!

Hot air flows out from the ventilation opening on the hob. Never touch the ventilation opening.

Please note that, in the case of appliances with a hob cover, the burners in the oven must also only be switched on if the hob cover is open.

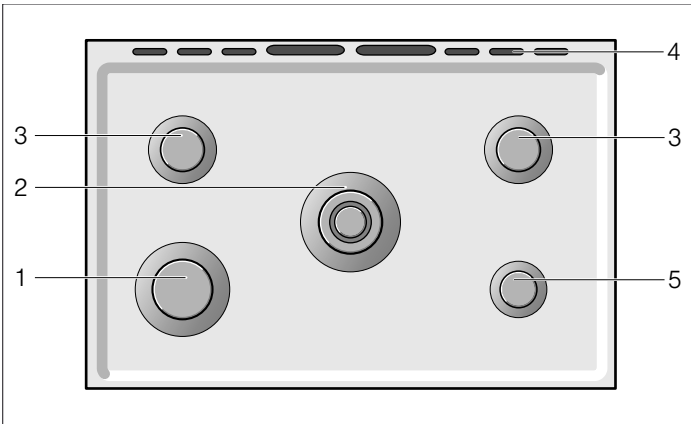

Description

1	High output burner (2.9 kW)
2	Wok burner (3.6 kW)
3	Standard output burner (1.65 kW)
4	Steam outlet
5	Economy burner (0.9 kW)

Types of gas burner

Gas burner	Pot/pan diameter
Economy burner	12 - 18 cm
Standard output burner	14 - 22 cm
High output burner	22 - 26 cm
Wok burner	22 - 26 cm

Precautions for use

The following advice is intended to help you save energy and prevent pan damage:

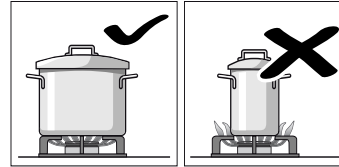

Use pans which are the right size for each burner.
Do not use small pans on large burners. The flame must not touch the sides of the pan.

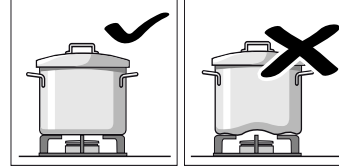

Do not use damaged pans, which do not sit evenly on the hob. Pans may tip over.
Only use pans with a thick, flat base.

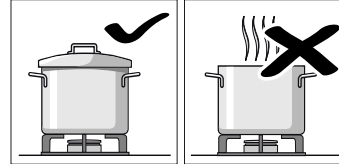

Do not cook without using a lid and make sure the lid is properly fitted. This wastes energy.

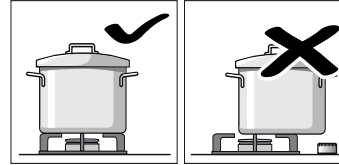

Always centre the pan over the burner, not to one side. Otherwise it could tip over.
Do not place large pans on the burners near the control knobs. These may be damaged by the very high temperatures.

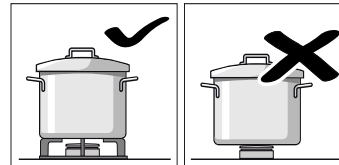

Place the pans on the pan supports, never directly on the burner.
Make sure that the pan supports and burner caps are correctly positioned before using the appliance.

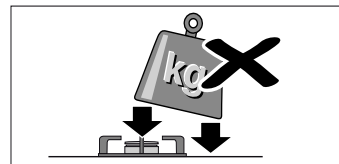

Pans should be placed on the hob carefully.
Do not strike the hob and do not place excessive weight on it.

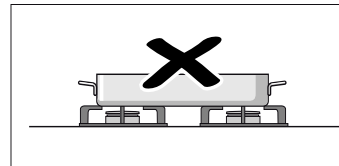

Never use two burners or heat sources to heat one single pan.
Do not use grill pans, earthenware casserole dishes, etc. for a long period of time on maximum power.

Control knob for hotplates

This control knob is used to adjust the heat setting of the gas burner hotplates.

The symbols above the control knob show you the gas burner to which the control knob belongs.

Position	Meaning
○	Off
⊕	Large flame, highest setting
⊖	Economy flame, lowest setting

Oven

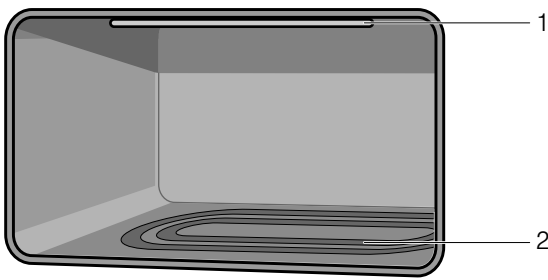

Description

- | | |
|---|--------------------------|
| 1 | Gas grill (3.1 kW) |
| 2 | Oven gas burner (4.2 kW) |

Control knob for oven

This control knob is used to adjust the heat setting of the oven.

Position	Meaning
○	Off. The oven is not heating up.
140 - 280	Oven gas burner on, temperature range in °C

There is a limit stop between positions 280 and ○. Do not turn the control knob beyond this point.

Control knob for grill

This control knob is used to adjust the heat setting of the grill.

Position	Meaning
○	Off. In this position, the grill does not heat
🔥	Large flame, highest setting
🔥	Economy flame, lowest setting

There is a limit stop between positions 🔥 and ○. Do not turn the knob beyond this point.

Control knob for the oven light and rotisserie spit

You can use this control knob to switch the oven light and rotisserie spit on and off.

Position	Meaning
●	Off
🔦	Switching on the oven light
🍴	Switching on the rotisserie spit and oven light

The cooking compartment

The oven light is located in the cooking compartment.

Steam outlet

The hot air from the cooking compartment escapes at the rear of the hob. Caution: do not cover the ventilation slots. Otherwise the oven will overheat.

Cooling fan

The hot air escapes via the ventilation opening. This cooling fan switches on and off as required. Caution! Do not cover the ventilation slots. Otherwise the oven will overheat.

The storage compartment

Open the storage compartment by folding down the fascia panel.

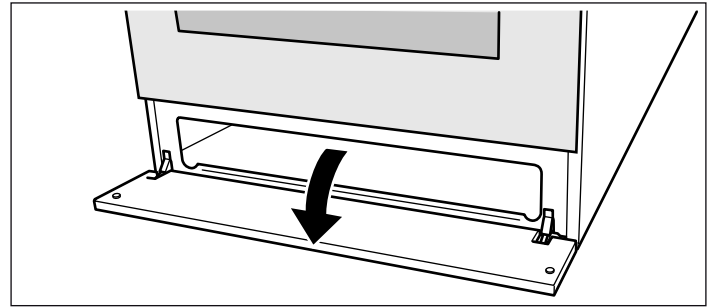

This compartment can be used to store hob or oven accessories.

⚠ Risk of fire!

Never leave combustible items in the storage compartment.

Accessories

Your appliance is accompanied by a range of accessories. Here, you can find an overview of the accessories included and information on how to use them correctly.



Baking and roasting shelf

For ovenware, cake tins, joints of meat, grilled items and frozen meals.



Universal pan

For moist cakes, pastries, frozen food and large joints of meat. The universal pan can be used to catch dripping fat when grilling directly on the wire rack.



Coffee maker trivet

Coffee maker trivet; place on the economy burner.

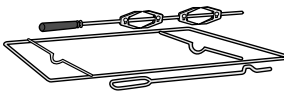

Rotisserie spit

With spit adaptor and metal frame
For roasting joints and large items of poultry.

The baking tray and the wire rack can be pushed into five different levels in the cooking compartment. Always push accessories in fully so that they do not touch the door panel. Make sure that you always insert the accessories into the cooking compartment the right way round.

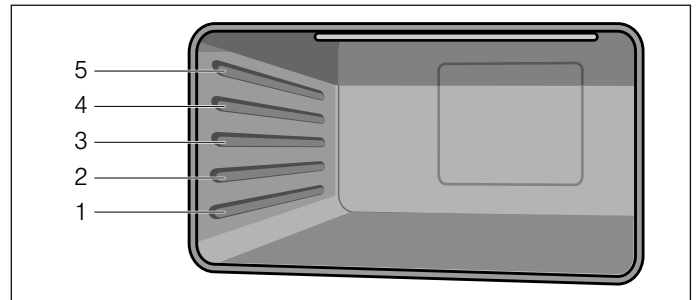

Risk of fire!

Under no circumstances should a roasting tin, baking tray, frying pan or any other form of cookware be placed directly on the oven floor. This causes the floor of the appliance to overheat and can seriously damage the appliance.

Before using for the first time

In this section, you can find out what you must do before using your oven or hob to prepare food for the first time. Read the following section beforehand.

Remove the appliance packaging and dispose of it appropriately.

Baking out the oven

Precleaning the oven

1. Remove accessories and hook-in racks from the cooking compartment.
2. Fully remove any remaining packaging, such as small pieces of polystyrene, from the cooking compartment.
3. Some parts are covered with a protective film. Remove the protective film.
4. Clean the outside of the appliance with a soft, damp cloth.
5. Clean the cooking compartment with hot soapy water.

Heating up the oven

To remove the new cooker smell, heat up the oven when it is empty and closed.

1. Turn the temperature selector to the maximum temperature.
2. Switch off the oven after 45 minutes.

Cleaning the burner caps and cups

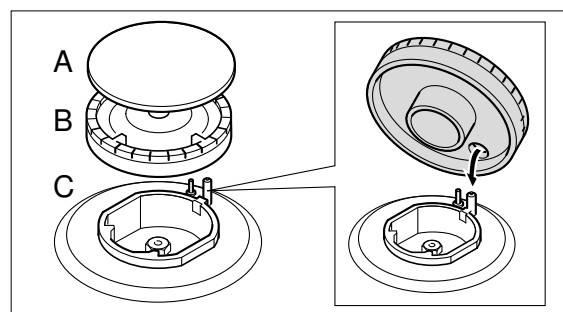

1. Clean the burner caps (A) and cups (B) with water and washing-up liquid.
2. Dry the parts well.
3. Place the burner cup (B) onto the burner (C).
4. Position the burner cap (A) exactly on the burner cup (B).

Cleaning the accessories

Before using the accessories, clean them thoroughly using a cloth and warm soapy water.

Operating the appliance



You have already learnt about the controls and how they work. Now we will explain how to set your appliance. You will learn about what happens when you switch the appliance on and off, and how to select the operating mode.





Hob

Switching on the gas burner

Notes

- Appliances with a hob cover must only be switched on if the hob cover is open.
 - The burner caps must always be positioned exactly on top of the burner cups. The slots on the burner cup must be free from obstruction. All parts must be dry.
 - Ensure that the burner is not subjected to draughts caused by air conditioning systems, fans or similar appliances.
1. Press the control knob for the hotplate you require and turn it to position .
Gas will begin to flow out and the gas burner will ignite.
 2. Press and hold the control knob for a few seconds until the flame stabilises.
 3. Select the required setting.

Position	Meaning
	Off
	Large flame, highest setting
	Economy flame, lowest setting

The flame is not stable between positions  and . Always select a position between  and .

If the flame goes out

Switch off the control knob. Wait one minute and switch the burner on again.

Risk of fire!

If the flame goes out, gas will escape. Never leave the gas burner unattended during operation. Ensure that there are no draughts.

If the gas burner does not ignite

In the event of a power cut or damp ignition plugs, light the gas burner with a gas lighter or a match.

Switching off the gas burner

Turn the control knob for the required hotplate to position .

Oven

Operating the oven

Note that, in the case of appliances with a hob cover, the burners in the oven must only be switched on if the hob cover is open.

Risk of overheating!

The cooling fan will not work without power. The appliance could overheat. Never operate the oven without power.

Oven lighting

Switching on the oven light

Turn the control knob to position .





Switching off the oven light

Turn the control knob to position .

The oven light will now switch off.

Operating modes

The following operating modes are available:

	Operating mode	Use
	Oven gas burner 140 - 280 °C	For cakes and pastries, bakes, poultry, lean joints of meat, e.g. beef, veal and game.
	Gas grill	For steak, sausages, fish and toasted sandwiches.
 and 	Combi mode (oven gas burner and grill gas burner)	For cakes and pastries, bakes, toasted sandwiches, poultry, fish, joints of meat, sausages and steak.

Operating the oven

Switching on the oven gas burner

1. Open the appliance door.
2. Press the control knob for the oven and turn it to the maximum position.
3. While holding the switch for the lower gas burner depressed, press the ignition button .
The gas escaping from the oven's lower gas burner is ignited using the ignition button.
4. Close the appliance door carefully.

If the flame goes out

Switch off the control knob. Wait one minute and switch the burner on again.

Risk of fire!

If the flame goes out, gas will escape. Never leave the gas burner unattended during operation. Ensure that there are no draughts.

Switching off the oven gas burner



Turn the control knob to the  position. Press and hold the control knob while doing this.





Operating the grill

The appliance door must be closed during grilling.

Note: When using the grill, a cooking time of 60 minutes must not be exceeded.

1. Open the appliance door.
2. Press and hold the control knob for the grill and turn it to position .
The gas burner will ignite.
3. Press and hold the control knob for a few seconds until the flame stabilises.
4. Select the required setting.

Position	Meaning
	Off. In this position, the grill does not heat
	Large flame, highest setting
	Economy flame, lowest setting

Note: The flame is not stable between positions  and .
Always select a position between  and .

5. Close the appliance door carefully.

If the flame goes out

Switch off the control knob. Wait one minute and switch the burner on again.

Risk of fire!

If the flame goes out, gas will escape. Never leave the gas burner unattended during operation. Ensure that there are no draughts.

Switching off the grill

Turn the control knob to position .

Using combi mode

Notes

- The temperature range marked on the control knob for the oven applies only when using conventional heating. In combi mode, the temperature in the oven is higher than the temperature that has been set.
- When you use the gas grill on the lowest setting, you must also set the oven to the lowest heat setting.

Switching on combi mode

1. Open the appliance door.
2. Press and hold the control knob for the grill and turn it anti-clockwise to the "Max." position.
The grill gas burner will ignite. Press and hold the control knob for a few seconds until the flame stabilises.
3. Carefully close the appliance door.
4. Open the appliance door after 10 minutes.
5. Press and hold the control knob for the oven and turn it anti-clockwise to the maximum temperature.
The oven gas burner will ignite. Press and hold the control knob for a few seconds until the flame stabilises.
6. Carefully close the appliance door.
7. Set the required temperature using the control knob for the grill and oven.
8. Wait 15 minutes for the oven to heat up. Carefully open the appliance door and slide the baking tray in.

Notes

- If the gas burner does not ignite within 15 seconds, stop attempting to ignite the flame, open the appliance door and wait for 60 seconds.
- If the flame inadvertently goes out, turn the control knob to the "0" position and wait for 60 seconds.

Switching on the grill

To achieve an extra gold top on certain dishes, the grill can be switched on briefly at the end of the cooking time when using conventional heating.

1. Open the appliance door.
2. Press and hold the control knob for the grill and turn it anti-clockwise to switch on the grill.
The grill gas burner will ignite. Press and hold the control knob for a few seconds until the flame stabilises.
3. Set the required temperature using the control knob for the oven/gas grill.
4. Carefully close the appliance door.

Switching off combi mode

Turn the control knob for the grill and oven to the  position.

Rotary spit

Preparing the rotary spit

1. Slide a retaining clip onto the rotary spit and screw on the handle.

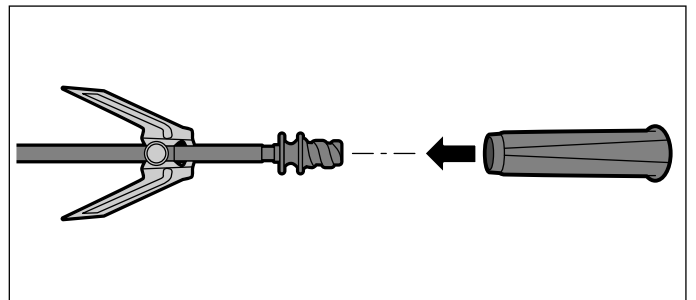

2. Place the roast as close as possible to the centre of the rotary spit.
3. Use retaining clips to secure the roast in place.
4. Use milled screws to secure the retaining clips.

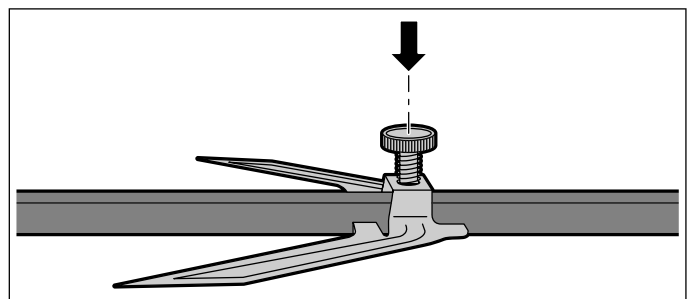

Inserting the rotisserie spit

Risk of burns!

Never touch the hot surfaces of the cooking compartment or the heating elements. Children must be kept at a safe distance from the appliance at all times. Open the appliance door carefully. Hot steam may escape.

1. Push the rotisserie spit rack fully into the appliance on shelf level 3.
2. Place the rotisserie spit onto the rotisserie spit rack and unscrew the handle.

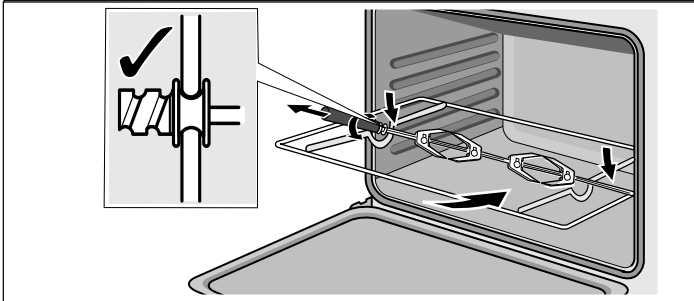

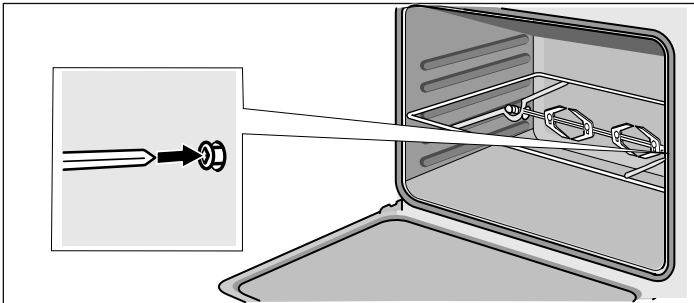

3. Push the rotisserie spit rack in fully.
4. Push the rotisserie spit rack to the right and into the motor adaptor.



5. Pour water into a baking tray and slide it in on shelf level 1 to collect any fat that drips out.
6. Close the appliance door.

Switching on the rotary spit

Note: Preheat the oven with the  heating function if you are using the rotisserie spit.

1. Turn the control knob for the oven to position .
2. Set the temperature.

Note: Pour some water into the universal pan to catch any fat that drips out.

Removing the rotisserie spit

Risk of burns!

Never touch the hot surfaces of the cooking compartment or the heating elements. Children must be kept at a safe distance from the appliance at all times. Open the appliance door carefully. Hot steam may escape.

Risk of burns!

Never directly touch the rotisserie spit or other accessories when they are hot. Always use a pot holder or wear oven gloves to handle accessories when they are hot.

1. Open the appliance door carefully.
2. Pull the rotisserie spit rack with the metal frame to the left and out of the motor adaptor.

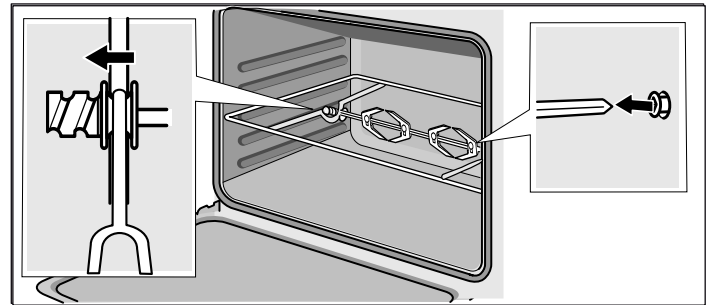

3. Pull the rotisserie spit rack out of the oven as far as possible.
4. Hold the rotisserie spit on the right-hand side with a pot holder and screw the grill onto the rotisserie spit.

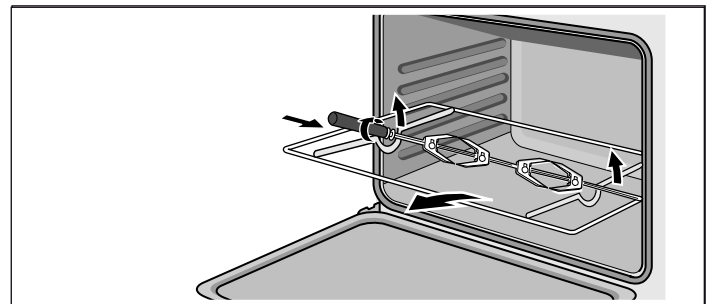

5. Carefully lift the rotisserie spit off the rotisserie spit rack.
6. Remove the rotary spit rack and the baking tray from the oven.

Care and cleaning

With attentive care and cleaning, your hob and oven will retain its looks and remain in good working order for a long time. We will explain here how you should care for and clean them correctly.

Notes

- Slight differences in the colours on the front of the oven are caused by the use of different materials, such as glass, plastic and metal.
- Shadows on the door panel which look like streaks, are caused by reflections made by the oven light.
- Enamel is baked on at very high temperatures. This can cause some slight colour variations. This is normal and does not affect operation. The edges of thin trays cannot be completely enamelled. As a result, these edges can be rough. This will not impair the anti-corrosion protection.

Risk of electric shock!

Do not use any high-pressure cleaners or steam cleaners, which can result in an electric shock.

Risk of burns!

The appliance becomes very hot. Never touch the interior surfaces of the cooking compartment or the heating elements. Always allow the appliance to cool down. Keep children at a safe distance.

Cleaning agents

Damage to the various different surfaces caused by using the wrong cleaning agent can be avoided by observing the following instructions.

When cleaning the hob do not use

- undiluted washing-up liquid or dishwasher detergent,
- scouring pads,
- abrasive cleaning agents such as oven cleaner or stain remover,
- high-pressure cleaners or steam jets.
- Do not clean individual parts in the dishwasher.

When cleaning the oven do not use

- sharp or abrasive cleaning agents,
- cleaning agent with a high alcohol content,
- scouring pads,
- high-pressure cleaners or steam jets.
- Do not clean individual parts in the dishwasher.

Wash new sponges thoroughly before first use.

Zone	Cleaning agent
Stainless steel surfaces* (depending on appliance model)	Hot soapy water: Clean with a dish cloth and dry with a soft cloth. On stainless steel surfaces, always wipe parallel to the natural grain. Otherwise, you may scratch the surface. Remove patches and splashes of limescale, grease, starch and albumin (e.g. egg white) immediately. Corrosion can form under such patches and splashes. Special care products suitable for hot stainless steel surfaces are available from our after-sales service and from specialist retailers. Apply a thin layer of care product with a soft cloth.

* Optional (available for some appliances, depending on the appliance model)

Zone	Cleaning agent
Enamel, painted, plastic and screen-printed surfaces* (depending on appliance model)	Hot soapy water: Clean with a dish cloth and dry with a soft cloth. Do not use glass cleaner or glass scrapers for cleaning.
Control panel	Hot soapy water: Clean with a dish cloth and dry with a soft cloth. Do not use glass cleaner or glass scrapers for cleaning.
Upper glass cover* (depending on appliance model)	Glass cleaner: Clean with a soft cloth. You can remove the upper glass cover for cleaning. To find out how to do this, please refer to the section <i>Upper glass cover</i> .
Rotary knobs Do not remove.	Hot soapy water: Clean with a dish cloth and dry with a soft cloth.
Hob surround	Hot soapy water: Do not clean with a glass scraper, lemon juice or vinegar.
Gas hob and pan supports* (depending on appliance model)	Hot soapy water. Use very little water. Water must not be allowed to enter the appliance through the base of the burners. Clean off boiled-over liquids and spilt food immediately. You can remove the pan supports. Cast iron pan supports*: Do not clean in the dishwasher.
Gas burners* (depending on appliance model)	Remove the burner head and cap and clean with hot soapy water. Do not clean in the dishwasher. The gas outlet openings must remain unobstructed at all times. Ignition plugs: Small, soft brush. The gas burners only work properly when the ignition plugs are dry. Dry all parts thoroughly. Ensure that they are refitted correctly. The burner caps are coated in black enamel. The colour may change over time. This does not impair their performance.
Electric hotplate* (depending on appliance model)	Abrasive materials or sponges: Briefly heat up the hotplate afterwards, so that it dries. Hotplates can rust over time if they remain wet. Apply care product to finish. Clean off boiled-over liquids and spilt food immediately.
Hotplate ring* (depending on appliance model)	Remove yellow to blue iridescent discoloration from the hotplate ring with a steel care product. Do not use any abrasive materials that may scratch surfaces.

* Optional (available for some appliances, depending on the appliance model)

Zone	Cleaning agent
Ceramic hob* (depending on appliance model)	Care: Protective/care products for ceramics Cleaning: Cleaning agents suitable for ceramics. Follow the cleaning instructions on the packaging. ⚠ Glass scraper for stubborn dirt: Remove the protective cover and clean using the blade only. Caution: The blade is very sharp. Risk of injury. Cover the blade again after cleaning. Replace damaged blades immediately.
Glass hob* (depending on appliance model)	Care: Protective/care products for glass Cleaning: Cleaning agents for glass. Follow the cleaning instructions on the packaging. ⚠ Glass scraper for stubborn dirt: Remove the protective cover and clean using the blade only. Caution: The blade is very sharp. Risk of injury. Cover the blade again after cleaning. Replace damaged blades immediately.
Glass panel	Glass cleaner: Clean with a soft cloth. Do not use the glass scraper. The door can be removed to facilitate cleaning. To find out how to do this, please refer to the section <i>Removing and refitting the oven door</i> .
Childproof lock* (depending on appliance model)	Hot soapy water: Clean with a dish cloth. If a childproof lock has been fitted to the oven door, it must be removed before cleaning. If it is very dirty, the childproof lock will not work properly.
Seal Do not remove.	Hot soapy water: Clean with a dish cloth. Do not scour.
Cooking zone	Hot soapy water or a vinegar solution: Clean with a dish cloth. For stubborn dirt, use a stainless steel scouring pad or oven cleaner. Only use when the cooking compartment is cold. ⚠ Please use the self-cleaning function to clean self-cleaning surfaces. To find out how to do this, please refer to the section <i>Self-cleaning</i> . Caution! Never use oven cleaner on self-cleaning surfaces.
Glass cover for the oven light	Hot soapy water: Clean with a dish cloth.

* Optional (available for some appliances, depending on the appliance model)

Zone	Cleaning agent
Shelf	Hot soapy water: Clean with a dish cloth or a brush. You can remove the shelves for cleaning. To find out how to do this, please refer to the section <i>Removing and refitting shelves</i> . Telescoping extension rails* (depending on appliance model) Hot soapy water: Clean with a dish cloth or a brush. Do not remove the lubricant from the extension rails. It is best to clean them when they are pushed in. Do not soak, clean in the dishwasher, or clean in the oven as part of the self-cleaning programme. This may damage the shelves and they may no longer work properly as a result.
Accessories	Hot soapy water: Soak and then clean with a dish cloth or a brush. Aluminium baking tray*: (depending on appliance model) Dry with a soft cloth. Do not clean in the dishwasher. Never use oven cleaner. To prevent scratches, never touch the metal surfaces with a knife or a similar sharp object. Harsh cleaning products, scratchy sponges and rough cleaning cloths are not suitable. Otherwise, you may scratch the surface. Rotary spit* (depending on appliance model) Hot soapy water: Clean with a dish cloth or a brush. Do not clean in the dishwasher.
	Meat thermometer* (depending on appliance model) Hot soapy water: Clean with a dish cloth or a brush. Do not clean in the dishwasher.
Plinth drawer* (depending on appliance model)	Hot soapy water: Clean with a dish cloth.

* Optional (available for some appliances, depending on the appliance model)

Keeping the appliance clean

Always keep the appliance clean and remove dirt immediately so that stubborn deposits of dirt do not build up.

⚠ Risk of fire!

Loose food remnants, fat and meat juices may catch fire. Before using the appliance, remove the worst of the food remnants from the cooking compartment, heating elements and accessories.

Clean the cooking compartment after each use. This will ensure that dirt cannot be baked on.

Always remove flecks of limescale, grease, starch and albumin (e.g. egg white) immediately.

Use the universal pan for baking very moist cakes.

Use suitable ovenware for roasting, e.g. a roasting dish.

Appliance door

With good care and cleaning, your appliance will retain its appearance and remain fully functional for a long time to come. This will tell you how to clean the appliance door.

Detaching and attaching the oven door

For cleaning purposes and to remove the door panels, you can detach the oven door.

The oven door hinges each have a locking lever. When the locking levers are closed (figure A), the oven door is secured in place. It cannot be detached. When the locking levers are open in order to detach the oven door (figure B), the hinges are locked. They cannot snap shut.

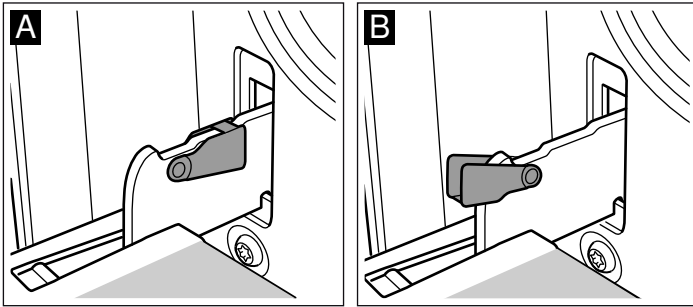

⚠ Risk of injury!

Whenever the hinges are not locked, they snap shut with great force. Ensure that the locking levers are always fully closed or, when detaching the oven door, fully open.

Detaching the door

1. Open the oven door fully.
2. Fold up the two locking levers on the left and right (figure A).
3. Close the oven door as far as the limit stop. With both hands, grip the door on the left and right-hand sides. Close the door a little further and pull it out (figure B).

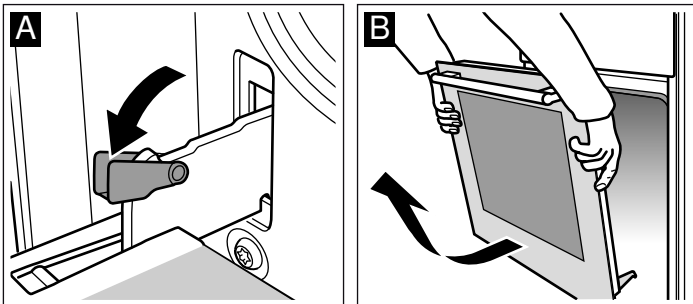

Attaching the door

Reattach the oven door in the reverse sequence to removal.

1. When attaching the oven door, ensure that both hinges are inserted straight into the opening (figure A).
2. The notch on the hinge must engage on both sides (figure B).

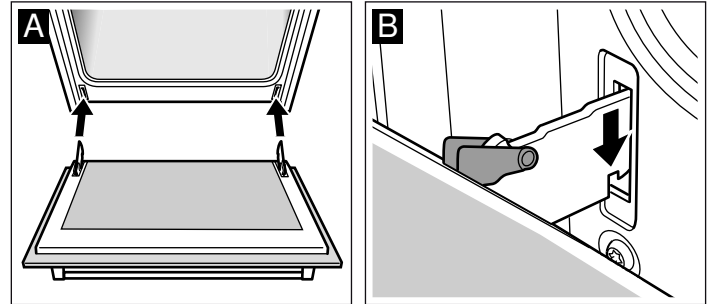

3. Fold back both locking levers (figure C). Close the oven door.

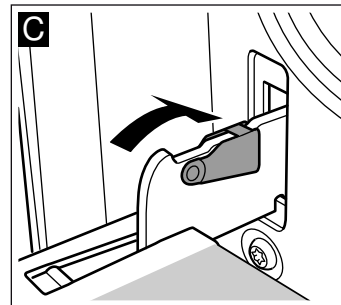

⚠ Risk of injury!

Risk of injury. If the oven door falls out accidentally or a hinge snaps shut, do not reach into the hinge. Call the after-sales service.

Trouble shooting

Faults often have simple explanations. Refer to the table before calling the after-sales service, as you may be able to remedy the fault yourself.

Risk of injury!

Incorrect repairs may cause serious hazards. Repairs to the appliance must only be carried out by a qualified technician. If repairs are required, contact the after-sales service.

Fault table

Fault	Possible cause	Remedy/information
The appliance is not working.	The circuit breaker is faulty	Look in the fuse box and check that the circuit breaker is in working order.
	Power cut	Check whether the kitchen light works.
The oven light has failed.	Faulty oven light	Change the oven light bulb. (See section "Replacing the oven light")
The gas burner will not ignite.	Power cut or damp ignition plugs	Light the gas burner with a gas lighter or a match.
		Do not operate the oven without power.
The flame (oven) does not burn through all outlet openings.	Normal build-up of dirt	The burner must be cleaned by a professional.
All dishes that are cooked in the oven burn within an extremely short period of time.	Faulty thermostat	Call the after-sales service.
The door panel steams up when the oven is hot.	Normal occurrence; caused by the difference in temperature	Not possible; this has no effect on oven performance.
The oven switches off.	The gas pressure is too high	Check whether the correct pressure regulator is being used.
	Power cut	Check the oven's power supply.

Replacing the oven light bulb

If the bulb in the oven light fails, it must be replaced. Replacement heat-resistant bulbs can be obtained from the after-sales service or from specialist retailers. Please supply your appliance's E number and FD number. Do not use any other type of bulb.

Risk of electric shock!

When replacing the cooking compartment bulb, the bulb socket contacts are live. Before replacing the bulb, unplug the appliance from the mains or switch off the circuit breaker in the fuse box.

1. Pull out the mains plug or switch off the circuit breaker.
2. Open the appliance door.
3. When the oven is cold, place a tea towel inside to prevent damage.

4. Remove the glass cover for the defective oven light in the cooking compartment.

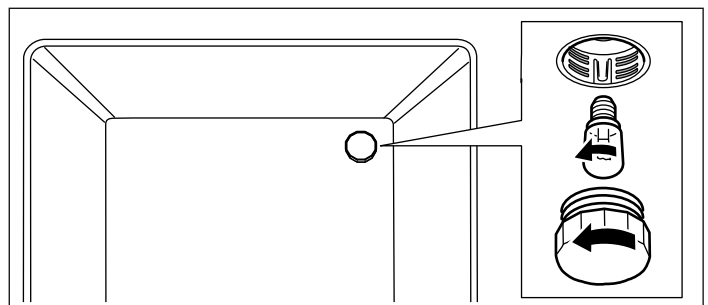

5. Replace the oven light bulb with one of the same type.
 - Voltage:** 230 V;
 - Power:** 25 W;
 - Thread:** E14;
 - Temperature resistance:** 300 °C
6. Put the glass cover for the oven light bulb back on.
7. Remove the tea towel and switch the circuit breaker back on or plug the mains plug in again.
8. Switch on the oven light and check that it is working correctly.

After-sales service

Our after-sales service is there for you if your appliance needs to be repaired. We will always find the right solution in order to avoid unnecessary visits from a service technician.

E number and FD number

When calling us, please give the product number (E no.) and the production number (FD no.) so that we can provide you with the correct advice. The rating plate containing these numbers can be found on the right-hand side of the oven door. You can make a note of the numbers of your appliance and the telephone number of the after-sales service in the space below to save time should it be required.

E no.

FD no.

After-sales service 

Please note that there will be a fee for a visit by a service technician in the event of a malfunction, even during the warranty period.

After-sales contact details for all countries can be found in the attached after-sales service directory.



BSH Hausgeräte GmbH
Carl-Wery-Straße 34, 81739 München
GERMANY

siemens-home.bsh-group.com

Manufactured by BSH Hausgeräte GmbH under Trademark License of Siemens AG



9001281555 02 220997