

SIEMENS



Extractor hood









LF959RB51, LF259RB51, LF959RA51B, LF959RB51B, LF959RB21, LF959RB21B

siemens-home.bsh-group.com/welcome

[en]Instruction manual

Register
your
product
online

Table of contents

	Important safety information	3
	Environmental protection	5
	Saving energy	5
	Environmentally-friendly disposal	5
	Operating modes	6
	Exhaust air mode	6
	Air recirculation	6
	Operating the appliance	6
	Controls	6
	Setting the fan	7
	Intensive setting	7
	Intermittent mode	7
	Run-on function	7
	Lighting	8
	Saturation signal	8
	Cleaning and maintenance	8
	Cleaning agents	8
	Cleaning the metal mesh grease filters	9
	Removing metal grease filter	9
	Installing the metal mesh grease filter	9
	Replacing the batteries in the remote control	9
	Trouble shooting	10
	Customer service	10
	Accessories for air recirculation mode	11

Additional information on products, accessories, replacement parts and services can be found at www.siemens-home.bsh-group.com and in the online shop www.siemens-home.bsh-group.com/eshops

Important safety information

Read these instructions carefully. Only then will you be able to operate your appliance safely and correctly. Retain the instruction manual and installation instructions for future use or for subsequent owners.

The appliance can only be used safely if it is correctly installed according to the safety instructions. The installer is responsible for ensuring that the appliance works perfectly at its installation location.

This appliance is intended for domestic use and the household environment only. The appliance is not intended for use outside. Do not leave the appliance unattended during operation. The manufacturer is not liable for damage which is caused by improper use or incorrect operation.

This appliance is intended for use up to a maximum height of 2000 metres above sea level.

This appliance is not intended for use by persons (including children) with reduced physical, sensory or mental capabilities, or lack of experience and knowledge, unless they have been given supervision or instruction concerning use of the appliance by a person responsible for their safety.

Children must not play with, on, or around the appliance. Children must not clean the appliance or carry out general maintenance unless they are at least 8 years old and are being supervised.

Keep children below the age of 8 years old at a safe distance from the appliance and power cable.

Check the appliance for damage after unpacking it. Do not connect the appliance if it has been damaged in transport.

Only a licensed professional may connect appliances without plugs. Damage caused by incorrect connection is not covered under warranty.

Warning – Danger of suffocation!

Packaging material is dangerous to children. Never allow children to play with packaging material.

⚠ Warning – Danger of death!

Risk of poisoning from flue gases that are drawn back in.

Always ensure adequate fresh air in the room if the appliance is being operated in exhaust air mode at the same time as room air-dependent heat-producing appliance is being operated.

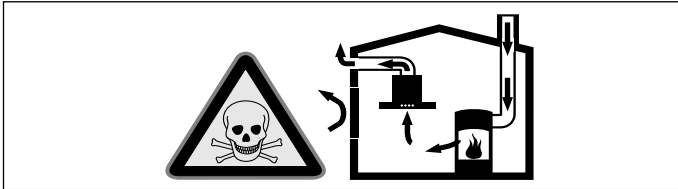

Room air-dependent heat-producing appliances (e.g. gas, oil, wood or coal-operated heaters, continuous flow heaters or water heaters) obtain combustion air from the room in which they are installed and discharge the exhaust gases into the open air through an exhaust gas system (e.g. a chimney).

In combination with an activated vapour extractor hood, room air is extracted from the kitchen and neighbouring rooms - a partial vacuum is produced if not enough fresh air is supplied. Toxic gases from the chimney or the extraction shaft are sucked back into the living space.

- Adequate incoming air must therefore always be ensured.
- An incoming/exhaust air wall box alone will not ensure compliance with the limit.

Safe operation is possible only when the partial vacuum in the place where the heat-producing appliance is installed does not exceed 4 Pa (0.04 mbar). This can be achieved when the air needed for combustion is able to enter through openings that cannot be sealed, for example in doors, windows, incoming/exhaust air wall boxes or by other technical means.

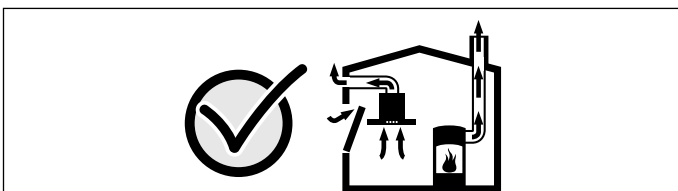

In any case, consult your responsible Master Chimney Sweep. He is able to assess the house's entire ventilation setup and will suggest the suitable ventilation measures to you.

Unrestricted operation is possible if the vapour extractor hood is operated exclusively in the circulating-air mode.

⚠ Warning – Risk of fire!

- Grease deposits in the grease filter may catch fire.

Clean the grease filter at least every 2 months.

Never operate the appliance without the grease filter.

- Grease deposits in the grease filter may catch fire. Never work with naked flames close to the appliance (e.g. flambéing). Do not install the appliance near a heat-producing appliance for solid fuel (e.g. wood or coal) unless a closed, non-removable cover is available. There must be no flying sparks.
- Hot oil and fat can ignite very quickly. Never leave hot fat or oil unattended. Never use water to put out burning oil or fat. Switch off the hotplate. Extinguish flames carefully using a lid, fire blanket or something similar.
- When gas burners are in operation without any cookware placed on them, they can build up a lot of heat. A ventilation appliance installed above the cooker may become damaged or catch fire. Only operate the gas burners with cookware on them.
- Operating several gas burners at the same time gives rise to a great deal of heat. A ventilation appliance installed above the cooker may become damaged or catch fire. Never operate two gas burners simultaneously on the highest flame for longer than 15 minutes. One large burner of more than 5 kW (wok) is equivalent to the power of two gas burners.

⚠ Warning – Risk of burns!

The accessible parts become very hot when in operation. Never touch hot parts. Keep children at a safe distance.

⚠ Warning – Risk of injury!

- Components inside the appliance may have sharp edges. Wear protective gloves.
- Items placed on the appliance may fall down. Do not place any objects on the appliance.
- The light emitted by LED lights is very dazzling, and can damage the eyes (risk group 1). Do not look directly into the switched on LED lights for longer than 100 seconds.

⚠ Warning – Risk of electric shock!

- A defective appliance may cause electric shock. Never switch on a defective appliance. Unplug the appliance from the mains or switch off the circuit breaker in the fuse box. Contact the after-sales service.
- Incorrect repairs are dangerous. Repairs may only be carried out and damaged power cables replaced by one of our trained after-sales technicians. If the appliance is defective, unplug the appliance from the mains or switch off the circuit breaker in the fuse box. Contact the after-sales service.
- Do not use any high-pressure cleaners or steam cleaners, which can result in an electric shock.

Causes of damage**Caution!**

Risk of damage due to corrosion. Always switch on the appliance while cooking to avoid condensation. Condensate can produce corrosion damage.

Always replace faulty bulbs to prevent the remaining bulbs from overloading.

Risk of damage due to ingress of humidity into the electronic circuitry. Never clean operator controls with a wet cloth.

Surface damage due to incorrect cleaning. Clean stainless steel surfaces in the direction of the grain only. Do not use any stainless steel cleaners for operator controls.

Surface damage due to strong or abrasive cleaning agents. Never use strong and abrasive cleaning agents.

Risk of damage from returning condensate. Install the exhaust duct in such a way that it falls away from the appliance slightly (1° slope).

 Environmental protection

Your new appliance is particularly energy-efficient. Here you can find tips on how to save even more energy when using the appliance, and how to dispose of your appliance properly.

Saving energy

- Only switch the ventilation on when necessary. You do not need to switch the ventilation on when cooking something for a short time that does not have a strong smell.
- Select a fan setting according to what you are cooking.
- Switch the ventilation off again after cooking.
- Cleaning the grease filter regularly will increase the efficiency of the ventilation.

Environmentally-friendly disposal

Dispose of packaging in an environmentally-friendly manner.



This appliance is labelled in accordance with European Directive 2012/19/EU concerning used electrical and electronic appliances (waste electrical and electronic equipment - WEEE). The guideline determines the framework for the return and recycling of used appliances as applicable throughout the EU.

Operating modes

Exhaust air mode



The air which is drawn in is cleaned by the grease filters and conveyed to the exterior by a pipe system.

Note: The air must not be discharged into a flue that is used for exhausting fumes from appliances burning gas or other fuels (not applicable to appliances that only discharge the air back into the room).

- Before conveying the exhaust air into a non-functioning smoke or exhaust gas flue, obtain the consent of the heating engineer responsible.
- If the exhaust air is conveyed through the outer wall, a telescopic wall box should be used.

Air recirculation



The air which is drawn in is cleaned by the grease filters and an activated carbon filter, and is conveyed back into the kitchen.

Note: To bind odours in air recirculation mode, you must install an activated carbon filter. The different options for operating the appliance in air recirculation mode can be found in the brochure. Alternatively, ask your dealer. The required accessories are available from specialist retailers, from customer service or from the Online Shop.

Operating the appliance

Notes

- Press the buttons briefly to activate the various functions. The function you are trying to select will not be activated if you hold the button down for too long.
- The appliance will emit a beep to confirm that a button has been pressed.

Note: Switch on the extractor hood when you start cooking and switch it off again several minutes after you have finished cooking. This is the most effective way of removing the kitchen fumes.

Controls



Use the remote control to set and adjust the various different functions of your appliance.

Note: The remote control requires 23AE 12 V batteries. For information on how to insert the batteries, refer to the section entitled → "Cleaning and maintenance" on page 8

Note: Heat and penetrating moisture may damage the remote control. Never expose the remote control to intense heat or moisture.



Remote control



1. Press the  button. *!* will appear in the display.
2. Press the **+** button. The following fan settings will appear in the display: *2* → *3* → *!* → *2*, etc.
3. Press the  button to confirm the fan setting for intermittent mode.

Note: Pressing any of the buttons (except the button for the light) will deactivate intermittent mode.

Operating buttons

Explanation	
	Light on/off/dimming
	Intermittent ventilation
	Fan run-on
+	Increase fan setting
-	Decrease fan setting

Connecting the remote control to the appliance

If the appliance cannot be operated with the remote control, e.g. after the battery has been changed, the connection between the remote control and the appliance must be re-established.

1. Press and hold the **+** button.
2. Attach the appliance to the mains voltage.
A long audible signal sounds. The remote control has been connected to the appliance.

Note: If no audible signal sounds within 30 seconds, repeat this procedure.

Extractor hood's control panel

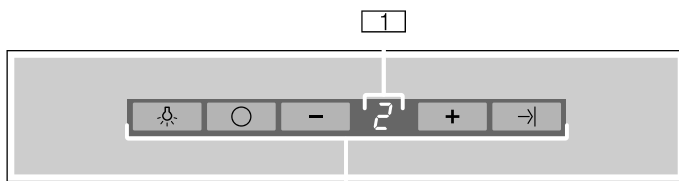

1	Fan settings display
2	Operating buttons

Operating buttons

Explanation	
Light icon	Light on/off/dimming
○	Switches the extractor hood on and off
−	Decrease fan setting
+	Increase fan setting
→	Fan run-on

Setting the fan

Note: Always adjust the setting according to the current conditions. To eliminate strong cooking smells, select a high fan setting.

Switching on

1. Press the **+** button.
The fan will start at fan setting 2.
2. Press the **+** or **−** button to set a different fan setting.

Note: The appliance has three fan settings and an intensive setting. To set the lowest setting, press **−** once. If you press it more than once, the appliance will switch off again.

Switching off

Press and hold the **−** button until the appliance switches off.

or press the ○ button.

Intensive setting

You can use the intensive setting if there is a large build-up of odours and fumes/vapours.

Press and hold the **+** button until **P** appears in the fan settings display .

Note: Intensive mode runs for four minutes. Once this time has elapsed, the appliance will switch back to fan setting 2.

Intermittent mode

Intermittent mode automatically switches on the extractor hood for 10 minutes every hour. The function switches itself off again after 24 hours.

This function can be activated from the control panel or using the remote control.

Note: If intensive mode or the run-on function has been activated, the intermittent function will not be available.

Switching on intermittent mode from the control panel

1. Press the ○ and **+** buttons at the same time until **!** appears in the display.
2. Press the **+** button. The following fan settings will appear in the display: 2 → 3 → 1 → 2, etc.
3. Press the ○ and **+** buttons at the same time to confirm the fan setting for intermittent mode.

Switching on intermittent mode using the remote control

1. Press the **!** button. **!** will appear in the display.
2. Press the **+** button. The following fan settings will appear in the display: 2 → 3 → 1 → 2, etc.
3. Press the **!** button to confirm the fan setting for intermittent mode.

Note: Pressing any of the buttons (except the button for the light) will deactivate intermittent mode.

Run-on function

The run-on function allows the extractor hood to continue running for a few minutes after it has been switched off. This eliminates any remaining cooking smells. The extractor hood will then switch itself off automatically.

Switching on

Note: If intensive mode has been activated, the run-on function will not be available.

Press the →| button on the control panel or the |→| button on the remote control.

The fan will run for 10 minutes at setting **!** and a dot will flash in the display during this time. Then the fan will switch itself off automatically.

Switching off

Press the →| or ○ button on the control panel or the |→| button on the remote control for the extractor hood.

This will deactivate the run-on function immediately.



Lighting

The lighting can be switched on and off independently of the ventilation.

Press the  button.

Saturation signal

The following will happen when the filters are saturated:

- The  symbol appears in the display: Clean the metal grease filter
- The  symbol appears in the display and a signal sounds: Replace the activated charcoal filter



See the "CleanAir air recirculation module" printed supplement or the section entitled → "Cleaning and maintenance" on page 8

Resetting the saturation signal

When the fan is switched off, the signal is also switched off.

The relevant filter(s) should be cleaned now if you have not already done so.



Switching over the appliance to air recirculation

1. Switch off the appliance.
2. Press the  and  buttons on the control panel at the same time until the  indicator lights up. Then release the buttons.

The  indicator will go out shortly afterwards. The electronic controller has now been switched over to air recirculation mode.

Switching over the appliance to air extraction

Note: The default setting is air extraction mode.

1. Switch off the appliance.
2. Press the  and  buttons on the control panel at the same time until the  indicator lights up. Then release the buttons.

The  indicator will go out shortly afterwards. The electronic controller has now been switched over to air extraction mode.



Cleaning and maintenance

Warning – Risk of burns!

The appliance becomes hot during operation. Allow the appliance to cool down before cleaning.

Warning – Risk of electric shock!

Penetrating moisture may result in an electric shock. Clean the appliance using a damp cloth only. Before cleaning, pull out the mains plug or switch off the circuit breaker in the fuse box.

Warning – Risk of electric shock!

Do not use any high-pressure cleaners or steam cleaners, which can result in an electric shock.

Warning – Risk of injury!

Components inside the appliance may have sharp edges. Wear protective gloves.

Cleaning agents

To ensure that the different surfaces are not damaged by using the wrong cleaning agent, observe the information in the table. Do not use any of the following:

- Harsh or abrasive cleaning agents,
- Cleaning agents with a high alcohol content,
- Hard scouring pads or cleaning sponges,
- High-pressure cleaners or steam cleaners.

Wash new sponge cloths thoroughly before use.

Follow all instructions and warnings included with the cleaning agents.

Area	Cleaning agent
Stainless steel	Hot soapy water: Clean with a dish cloth and then dry with a soft cloth. Clean stainless steel surfaces in the grind direction only. Special stainless steel cleaning products are available from our after-sales service or from specialist retailers. Apply a very thin layer of the cleaning product with a soft cloth.
Painted surfaces	Hot soapy water: Clean using a damp dish cloth and dry with a soft cloth/towel. Do not use any stainless steel cleaners.
Aluminium and plastic	Glass cleaner: Clean with a soft cloth.
Glass	Glass cleaner: Clean with a soft cloth. Do not use a glass scraper.
Controls	Hot soapy water: Clean using a damp dish cloth and dry with a soft cloth/towel. Risk of electric shock caused by penetrating moisture. Risk of damage to the electronics from penetrating moisture. Never clean operating controls with a wet cloth. Do not use any stainless steel cleaners.

Cleaning the metal mesh grease filters

These instructions apply to several appliance variants. It is possible that individual features are described which do not apply to your appliance.

⚠ Warning – Risk of fire!

Grease deposits in the grease filter may catch fire.

Clean the grease filter at least every 2 months.

Never operate the appliance without the grease filter.

Notes

- Do not use any aggressive, acidic or alkaline cleaning agents.
- When cleaning the metal mesh grease filters, also clean the holder for the metal mesh grease filters in the appliance using a damp cloth.
- The metal mesh grease filters can be cleaned in the dishwasher or by hand.

By hand:

Note: You can use a special grease solvent for stubborn dirt. It can be ordered via the Online Shop.

- Soak the metal mesh grease filters in a hot soapy solution.
- Clean the filters with a brush and then rinse them thoroughly.
- Leave the metal mesh grease filters to drain.

In the dishwasher:

Note: If the metal mesh grease filters are cleaned in the dishwasher, slight discolouration may occur. This has no effect on the function of the metal mesh grease filters.

- Do not clean heavily soiled metal mesh grease filters together with utensils.
- Place the metal mesh grease filters loosely in the dishwasher. The metal mesh grease filters must not be wedged in.

Removing metal grease filter

1. Open the filter cover by pulling it downwards.

Notes

- The filter cover is heavy. Hold the filter cover with both hands.
- Open the filter cover slowly and carefully.

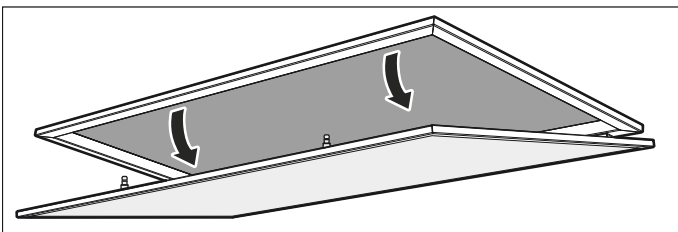

2. Press the lock on the metal grease filters.

Note: To avoid causing damage, do not bend the metal grease filter.

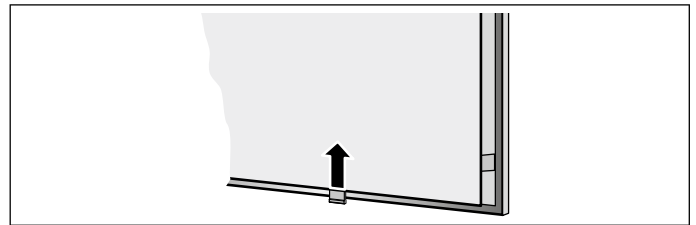

3. Take the metal grease filter out of the holder.

Note: Fat may accumulate in the bottom of the metal grease filter. Hold the metal grease filter level to prevent fat from dripping out.

4. Clean the appliance from the inside.
5. Clean the metal grease filter and let it dry before refitting it.

Installing the metal mesh grease filter

1. Insert metal grease filter. While doing this, place your other hand under the metal grease filter.

2. Fold up metal grease filter and engage the lock.

3. Close the filter cover upwards.

Note: Ensure that the filter cover lock engages correctly.

Replacing the batteries in the remote control

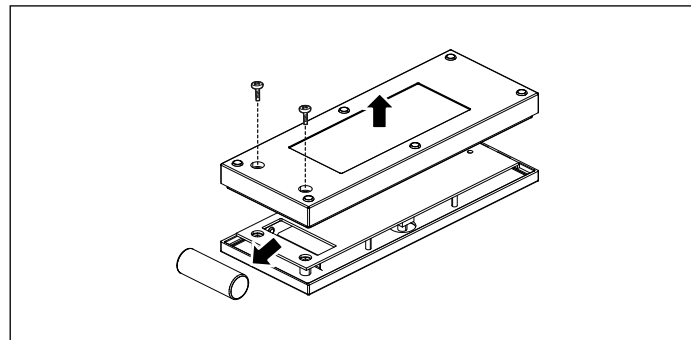

1. Undo screws.
2. Remove cover.
3. Remove the batteries.
4. Correctly insert the new batteries (23AE 12 V).
5. Dispose of flat or faulty batteries according to local regulations.

Note: Do not dispose of batteries in general household waste.

Trouble shooting

Malfunctions often have simple explanations. Please read the following notes before calling the after-sales service.

Warning – Risk of electric shock!

Incorrect repairs are dangerous. Repairs may only be carried out and damaged power cables replaced by one of our trained after-sales technicians. If the appliance is defective, unplug the appliance from the mains or switch off the circuit breaker in the fuse box. Contact the after-sales service.

LED lights

Defective LED lights must only be replaced by the manufacturer, their customer service department or a licensed technician (electrician).

Malfunction table

Fault	Possible cause	Solution
The appliance does not work	The plug is not plugged into the mains	Connect the appliance to the power supply
	Power cut	Check whether other kitchen appliances are working
	The fuse is faulty	Check in the fuse box to make sure that the fuse for the appliance is in working order
The lighting is not working	The LED lights are defective	Call the after-sales service
The  symbol appears in the display and a signal sounds.	The activated charcoal filter is saturated.	Replace the filter; see the "CleanAir air recirculation module" printed supplement
The remote control is not working	The battery is flat	Replace the batteries in the remote control. → "Cleaning and maintenance" on page 8
The appliance is not responding to the remote control	The remote control is not connected to the appliance	Connect the remote control to the appliance. → "Cleaning and maintenance" on page 8

Customer service

When calling us, please give the product number (E no.) and the production number (FD no.) so that we can provide you with the correct advice. The rating plate with these numbers can be found inside the appliance (remove the metal mesh grease filter to gain access).

You can make a note of the numbers of your appliance and the telephone number of the after-sales service in the space below to save time should it be required.

E no.	FD no.
After-sales service 	

Please be aware that a visit by an after-sales engineer will be charged if a problem turns out to be the result of operator error, even during the warranty period.

Please find the contact data of all countries in the enclosed customer service list.

To book an engineer visit and product advice

GB 0344 892 8999
Calls charged at local or mobile rate.

IE 01450 2655
0.03 € per minute at peak. Off peak 0.0088 € per minute.

Rely on the professionalism of the manufacturer. You can therefore be sure that the repair is carried out by trained service technicians who carry original spare parts for your appliances.

Accessories for air recirculation mode

(not supplied)

LZ56700

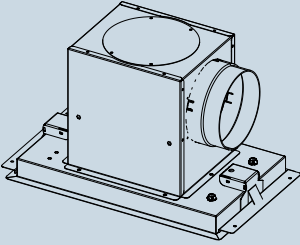

LZ56200

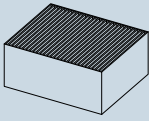

BSH Hausgeräte GmbH
Carl-Wery-Str. 34, 81739 München
GERMANY

siemens-home.bsh-group.com

Manufactured by BSH Hausgeräte GmbH under Trademark License of Siemens AG



9001255393
961012