

SIEMENS



Built-in oven

HR676GB.6B

siemens-home.bsh-group.com/welcome

en Instruction manual

Register
your
product
online

Table of contents

 Intended use	4	 Basic settings	18
 Important safety information	5	Changing settings	18
General information	5	List of settings	18
Steam	5	Changing the time	19
Cleaning function	6	 Steam	19
 Causes of damage	6	Noise	19
General information	6	Steam-assisted cooking	19
Steam	7	Reheating	19
 Environmental protection	7	Prove dough	20
Saving energy	7	Filling the water tank	20
Environmentally-friendly disposal	8	After every steam operation	21
 Getting to know your appliance	9	 Sabbath mode	22
Control panel	9	Starting Sabbath mode	22
Controls	9	 Cleaning function	22
Display	9	Self-cleaning	22
Operating modes menu	10	Prior to initiating the cleaning function	22
Types of heating	10	Setting the self-cleaning function	23
Steam	11	Once the cleaning function has ended	23
Further information	11	Descaling	23
Cooking compartment functions	11	 Home Connect	24
Water tank	12	Setting up	24
 Accessories	12	Remote Start	26
Accessories included	12	Home Connect settings	26
Inserting accessories	12	About data protection	27
Optional accessories	13	Declaration of Conformity	27
 Before using for the first time	14	 Cleaning agent	27
Before using for the first time	14	Suitable cleaning agents	27
Initial use	14	Keeping the appliance clean	28
Cleaning the cooking compartment	14	 Rails	29
Cleaning the accessories	14	Detaching and refitting the rails	29
 Operating the appliance	15	 Appliance door	29
Switching the appliance on and off	15	Removing and fitting the appliance door	29
Starting or interrupting operation	15	Removing the door cover	30
Selecting an operating mode	15	Removing and installing the door panels	30
Setting the type of heating and temperature	15	 Trouble shooting	32
Rapid heat up	16	Fault table	32
 Time-setting options	16	Maximum operating time exceeded	33
Timer	16	Cooking compartment bulbs	33
Cooking time	17	 Customer service	33
End time	17	E number and FD number	33
 Childproof lock	18	 Dishes	34
Activating and deactivating	18	Information on the settings	34
The appliance door is locked	18	Selecting a dish	34
		Applying settings for dishes	34



Tested for you in our cooking studio. 35

Silicone moulds 35
 Baking 35
 Roasting and braising 39
 Grilling 42
 Convenience products 45
 Yogurt 47
 Eco types of heating 47
 Acrylamide in foodstuffs. 48
 Slow cook 49
 Drying. 50
 Preserving 51
 Proving dough 52
 Defrosting. 53
 Reheating. 53
 Keeping warm 54
 Test dishes. 54

Additional information on products, accessories, replacement parts and services can be found at www.siemens-home.bsh-group.com and in the online shop www.siemens-home.bsh-group.com/eshops



Intended use

Read these instructions carefully. Only then will you be able to operate your appliance safely and correctly. Retain the instruction manual and installation instructions for future use or for subsequent owners.

This appliance is only intended to be fully fitted in a kitchen. Observe the special installation instructions.

Check the appliance for damage after unpacking it. Do not connect the appliance if it has been damaged in transport.

Only a licensed professional may connect appliances without plugs. Damage caused by incorrect connection is not covered under warranty.

This appliance is intended for domestic use only. The appliance must only be used for the preparation of food and drink. The appliance must be supervised during operation. Only use this appliance indoors.

This appliance is intended for use up to a maximum height of 4000 metres above sea level.

This appliance may be used by children over the age of 8 years old and by persons with reduced physical, sensory or mental capabilities or by persons with a lack of experience or knowledge if they are supervised or are instructed by a person responsible for their safety how to use the appliance safely and have understood the associated hazards.

Children must not play with, on, or around the appliance. Children must not clean the appliance or carry out general maintenance unless they are at least 15 years old and are being supervised.

Keep children below the age of 8 years old at a safe distance from the appliance and power cable.

Always slide accessories into the cooking compartment the right way round.

→ "Accessories" on page 12

Important safety information

General information

Warning – Risk of fire!

- Combustible items stored in the cooking compartment may catch fire. Never store combustible items in the cooking compartment. Never open the appliance door if there is smoke inside. Switch off the appliance and unplug it from the mains or switch off the circuit breaker in the fuse box.
- Loose food remnants, fat and meat juices may catch fire. Before using the appliance, remove the worst of the food remnants from the cooking compartment, heating elements and accessories.
- A draught is created when the appliance door is opened. Greaseproof paper may come into contact with the heating element and catch fire. Do not place greaseproof paper loosely over accessories during preheating. Always weight down the greaseproof paper with a dish or a baking tin. Only cover the surface required with greaseproof paper. Greaseproof paper must not protrude over the accessories.

Warning – Risk of burns!

- The appliance becomes very hot. Never touch the interior surfaces of the cooking compartment or the heating elements. Always allow the appliance to cool down. Keep children at a safe distance.
- Accessories and ovenware become very hot. Always use oven gloves to remove accessories or ovenware from the cooking compartment.
- Alcoholic vapours may catch fire in the hot cooking compartment. Never prepare food containing large quantities of drinks with a high alcohol content. Only use small quantities of drinks with a high alcohol content. Open the appliance door with care.

Warning – Risk of scalding!

- The accessible parts become hot during operation. Never touch the hot parts. Keep children at a safe distance.
- When you open the appliance door, hot steam can escape. Steam may not be visible, depending on its temperature. When opening, do not stand too close to the appliance. Open the appliance door carefully. Keep children away.

- Water in a hot cooking compartment may create hot steam. Never pour water into the hot cooking compartment.

Warning – Risk of injury!

- Scratched glass in the appliance door may develop into a crack. Do not use a glass scraper, sharp or abrasive cleaning aids or detergents.
- The hinges on the appliance door move when opening and closing the door, and you may be trapped. Keep your hands away from the hinges.

Warning – Risk of electric shock!

- Incorrect repairs are dangerous. Repairs may only be carried out and damaged power cables replaced by one of our trained after-sales technicians. If the appliance is defective, unplug the appliance from the mains or switch off the circuit breaker in the fuse box. Contact the after-sales service.
- The cable insulation on electrical appliances may melt when touching hot parts of the appliance. Never bring electrical appliance cables into contact with hot parts of the appliance.
- Do not use any high-pressure cleaners or steam cleaners, which can result in an electric shock.
- A defective appliance may cause electric shock. Never switch on a defective appliance. Unplug the appliance from the mains or switch off the circuit breaker in the fuse box. Contact the after-sales service.

Warning – Hazard due to magnetism!

Permanent magnets are used in the control panel or in the control elements. They may affect electronic implants, e.g. heart pacemakers or insulin pumps. Wearers of electronic implants must stay at least 10 cm away from the control panel.

Steam

Warning – Risk of scalding!

- The water in the water tank may become very hot if you continue to operate the appliance. Empty the water tank after every operation with steam.
- Hot steam is generated in the cooking compartment. Do not reach into the cooking compartment during any operation with steam.

- Hot liquid may spill over the sides of the accessory when it is removed from the cooking compartment. Remove hot accessories with care and always wear oven gloves.

⚠ Warning – Risk of injury and risk of fire!
Flammable liquids can catch fire in the cooking compartment when it is hot (explosion). Do not fill the water tank with any flammable fluids (e.g. alcoholic drinks). Only fill the water tank with water or with the descaling solution that is recommended by us.

Cleaning function

⚠ Warning – Risk of fire!

- Loose food residues, grease and meat juices may catch fire during the cleaning function. Before starting the cleaning function, remove coarse dirt from the cooking compartment and from the accessories.
- The appliance will become very hot on the outside during the cleaning function. Never hang combustible objects, e.g. tea towels, on the door handle. Do not place anything against the front of the appliance. Keep children away from the appliance.

⚠ Warning – Risk of serious damage to health!

The appliance will become very hot during the cleaning function. The non-stick coating on baking trays and tins is destroyed and noxious gases are released. Never clean non-stick baking trays and baking tins using the cleaning function. Only clean enamelled accessories using the cleaning function.

⚠ Warning – Risk of burns!

- The cooking compartment becomes extremely hot during the cleaning function. Never open the appliance door. Allow the appliance to cool down. Keep children away from the appliance.
- **⚠** The appliance will become very hot on the outside during the cleaning function. Never touch the appliance door. Allow the appliance to cool down. Keep children away from the appliance.

Causes of damage

General information

Caution!

- Accessories, foil, greaseproof paper or ovenware on the cooking compartment floor: do not place accessories on the cooking compartment floor. Do not cover the cooking compartment floor with any sort of foil or greaseproof paper. Do not place ovenware on the cooking compartment floor if a temperature of over 50 °C has been set. This will cause heat to accumulate. The baking and roasting times will no longer be correct and the enamel will be damaged.
- Aluminium foil: Aluminium foil in the cooking compartment must not come into contact with the door glass. This could cause permanent discolouration of the door glass.
- Water in a hot cooking compartment: do not pour water into the cooking compartment when it is hot. This will cause steam. The temperature change can cause damage to the enamel.
- Moisture in the cooking compartment: Over an extended period of time, moisture in the cooking compartment may lead to corrosion. Allow the cooking compartment to dry after use. Do not keep moist food in the closed cooking compartment for extended periods of time. Do not store food in the cooking compartment.
- Cooling with the appliance door open: Following operation at high temperatures, only allow the cooking compartment to cool down with the door closed. Do not trap anything in the appliance door. Even if the door is only left open a crack, the front of nearby furniture may become damaged over time. Only leave the cooking compartment to dry with the door open if a lot of moisture was produced whilst the oven was operating.
- Fruit juice: when baking particularly juicy fruit pies, do not pack the baking tray too generously. Fruit juice dripping from the baking tray leaves stains that cannot be removed. If possible, use the deeper universal pan.
- Extremely dirty seal: If the seal is very dirty, the appliance door will no longer close properly during operation. The fronts of adjacent units could be damaged. Always keep the seal clean.
- Appliance door as a seat, shelf or worktop: Do not sit on the appliance door, or place or hang anything on it. Do not place any cookware or accessories on the appliance door.
- Inserting accessories: depending on the appliance model, accessories can scratch the door panel when closing the appliance door. Always insert the accessories into the cooking compartment as far as they will go.
- Carrying the appliance: do not carry or hold the appliance by the door handle. The door handle cannot support the weight of the appliance and could break.

Steam

Caution!

- Baking tins: Ovenware must be heat and steam resistant. Silicone baking tins are not suitable for combined operation with steam.
- Ovenware with areas of rust: Do not use any ovenware which displays areas of rust. Even the smallest spots of rust can lead to corrosion in the cooking compartment.
- Dripping liquids: When steaming with a perforated cooking container, always insert the baking tray, the universal pan or the solid cooking container underneath. Dripping liquid is caught.
- Hot water in the water tank: Hot water can damage the pump. Only fill the water tank with cold water.
- Enamel damage: Do not start any operations when there is water on the cooking compartment floor. Before operation, wipe away the water from the cooking compartment floor.
- Descaling solution: Do not allow any descaling solution to come into contact with the control panel or other surfaces on the appliance. This damages the surfaces. If this does happen, remove the descaling solution immediately with water.
- Cleaning the water tank: Do not clean the water tank in the dishwasher. Otherwise, the water tank will be damaged. Clean the water tank with a soft cloth and standard washing-up liquid.

Environmental protection

Your new appliance is particularly energy-efficient. Here you can find tips on how to save even more energy when using the appliance, and how to dispose of your appliance properly.

Saving energy

- Only preheat the appliance if this is specified in the recipe or in the tables in the operating instructions.
- Leave frozen food to defrost before placing it in the cooking compartment.

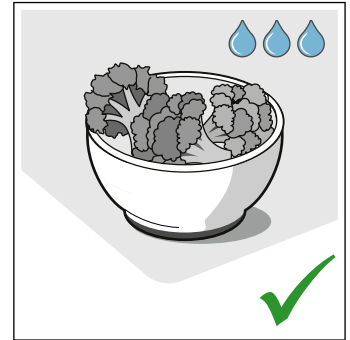
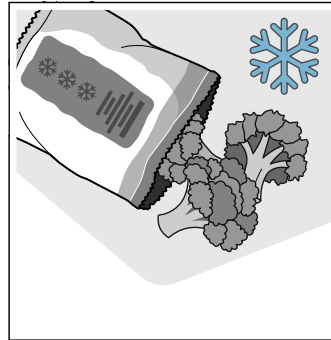

- Use baking tins that are dark-coloured, painted black or have an enamel coating. These absorb the heat particularly well.

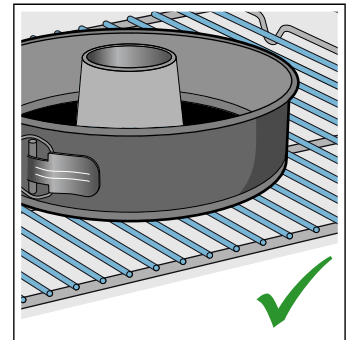
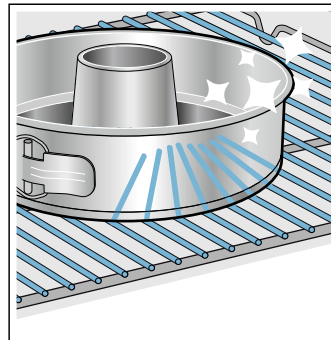

- Remove any unnecessary accessories from the cooking compartment.

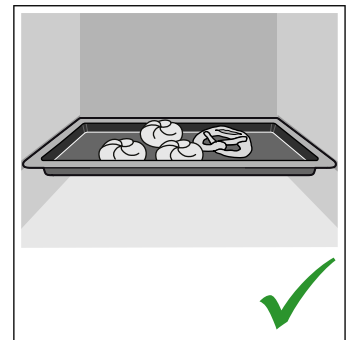
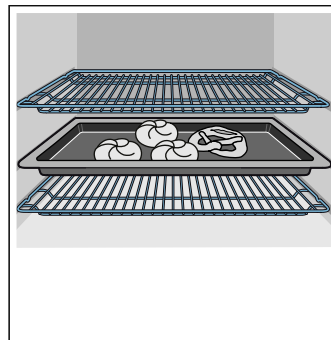

- Open the appliance door as infrequently as possible when the appliance is in use.

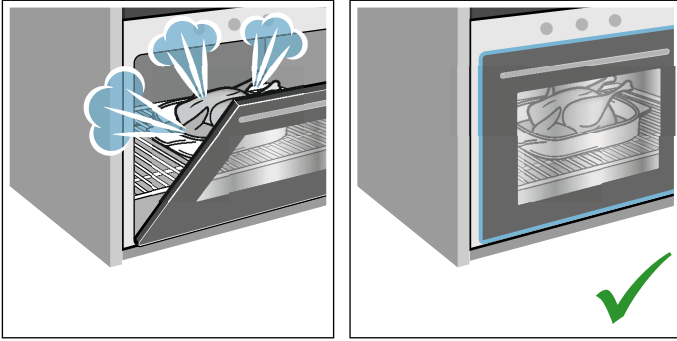

- It is best to bake several cakes one after the other. The cooking compartment stays warm. This reduces the baking time for the second cake. You can place two cake tins next to each other in the cooking compartment.

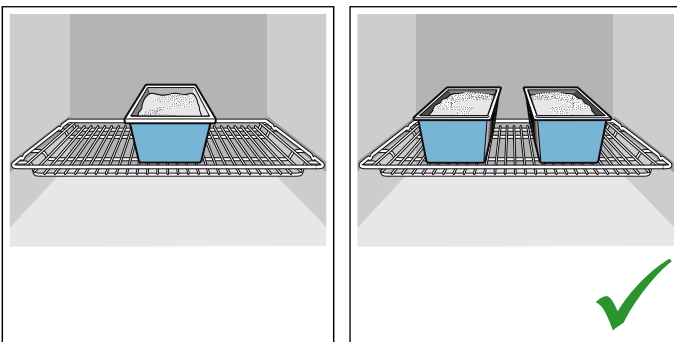

- For longer cooking times, you can switch the appliance off 10 minutes before the end of the cooking time and use the residual heat to finish cooking.

Environmentally-friendly disposal

Dispose of packaging in an environmentally-friendly manner.



This appliance is labelled in accordance with European Directive 2012/19/EU concerning used electrical and electronic appliances (waste electrical and electronic equipment - WEEE). The guideline determines the framework for the return and recycling of used appliances as applicable throughout the EU.

Getting to know your appliance

In this chapter, we will explain the indicators and controls. You will also find out about the various functions of your appliance.

Note: Depending on the appliance model, individual details and colours may differ.

Control panel

In the control panel, you can use the various buttons and the rotary selector to set the required function of the appliance. The current settings are shown on the display.

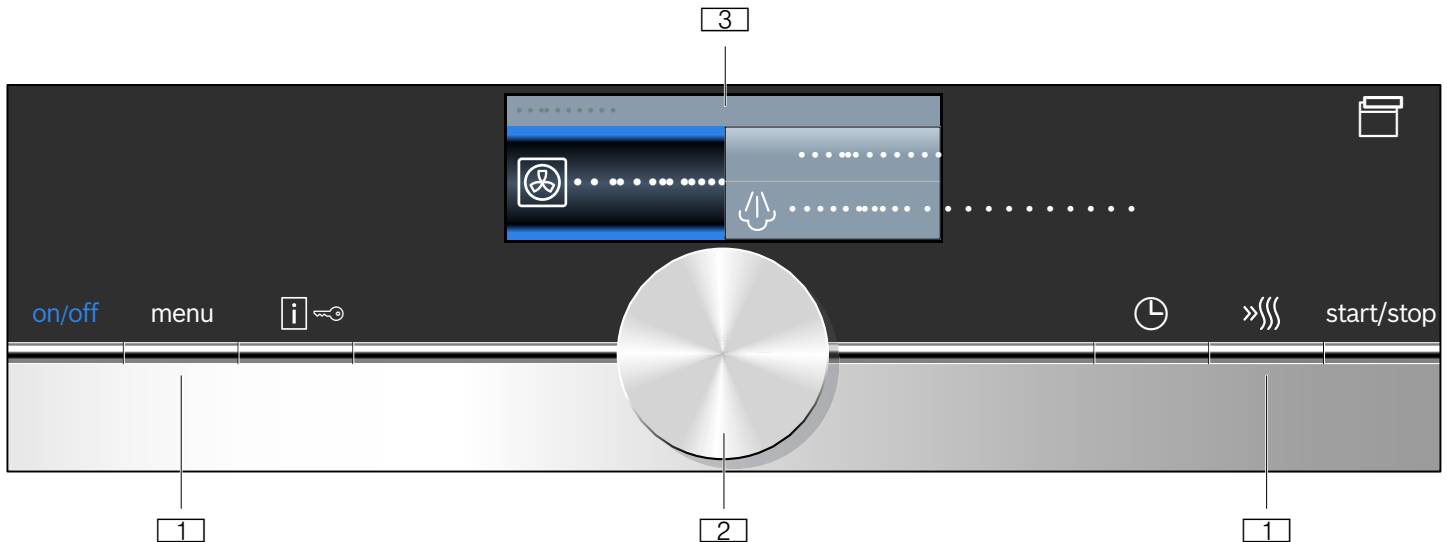

1 Buttons

The buttons to the left and right of the rotary selector have a pressure point. Press these buttons to activate them.

2 Rotary selector

You can turn the rotary selector clockwise and anti-clockwise.

3 Touch display

You can see the current adjustment values, options or notes in the touch display. To implement settings, touch the appropriate text field. The text fields change depending on the selection.

Start/Stop	Starts, pauses or cancels operation
Touch fields	
	Open panel
	Fill or empty the water tank

Rotary selector

Use the rotary selector to change the operating modes and adjustment values shown in the display.



In most selection lists, e.g. types of heating, the first selection follows the last. For temperature for example, you must turn the rotary selector back when the minimum or maximum temperature is reached.

Controls

The individual controls are adapted for the various functions of your appliance. You can set your appliance simply and directly.

Buttons and touch fields

Here you can find a short explanation of the various buttons and touch fields.

Buttons	Meaning	
on/off		Switches the appliance on and off
menu	Menu	Opens the operating modes menu
	Information	Displays notes
	Childproof lock	Activates/deactivates the childproof lock
	Time-setting options	Opens the time-setting options menu
	Rapid heat up	Switches rapid heat up on and off

Display

The display is structured so that the information can be read at a glance.

The value that you can currently set is in focus. It is displayed in white lettering with a dark background.

Status bar

The status bar is at the top of the display. The time and set time functions are displayed here.

Progress line

The progress line shows you how much the oven has already heated up or how much time has elapsed, for example. The straight line below the in-focus value progresses from left to right, the longer the operation continues to run.

Countdown

If you have started your appliance without a cooking time, you can see how long the operation has already been running for at the top right in the status bar.

If you had set a cooking time and it was deleted, the countdown applies the time that has already elapsed and continues to count down from this time. You can therefore always check how long the operation has already been running.

Temperature indicator

The temperature indicator bars show the heating phases or residual heat in the cooking compartment.

Heating indicator	The heating indicator displays the rising temperature in the cooking compartment. When all bars are filled, the optimum time for placing the dish in the oven has been reached. The bars do not appear when settings are applied for grilling and cleaning.
Residual heat indicator	When the appliance is switched off, the temperature indicator shows the residual heat in the cooking compartment. Once the temperature has dropped to approximately 60 °C, the display goes out.

Note: Due to thermal inertia, the temperature displayed may be slightly different to the actual temperature inside the oven. You can use the **i** button to check the current heating temperature when heating up.

Operating modes menu

The menu is divided into different operating modes. In this way, you can quickly access the required function.







Depending on the appliance type, there are a various number of operating modes. In the status bar at the top right, you can see how many pages there are in the operating modes menu. If 1/2 is displayed in the status bar, then you are on the first page of two pages.







Operating mode	Use
Types of heating	There are several finely tuned types of heating for you to prepare your dishes.
Dishes → "Dishes" on page 34	Here you can find pre-programmed setting values which are suitable for many dishes.
Steaming → "Steam" on page 19	There are finely tuned steam types of heating for you to prepare your dishes.
Drying → "Steam" on page 19	Use after every operation with steam.
Descalc → "Cleaning function" on page 22	You can use this to remove limescale from the evaporator.
Self-cleaning → "Cleaning function" on page 22	The self-cleaning function cleans your oven automatically.
Settings → "Basic settings" on page 18	You can adapt your appliance's basic settings to suit your needs.
HomeConnect → "Home Connect" on page 24	This function allows you to connect your oven with a mobile device.

Types of heating

In order for you to find the correct type of heating for your dish, we have explained the differences and scopes of application here.

When cooking at very high temperatures, the appliance lowers the temperature slightly after an extended period.

Types of heating	Temperature	Use
 4D hot air	30-275 °C	For baking and roasting on one or more levels. The fan distributes the heat from the ring heating element in the back panel evenly around the cooking compartment.
 Top/bottom heating	30-300 °C	For traditional baking and roasting on one level. Especially suitable for cakes with moist toppings. Heat is emitted evenly from above and below.
 Hot air eco	30-275 °C	For gentle cooking of selected dishes on one level without preheating. The fan distributes the heat from the ring heating element in the back panel around the cooking compartment.
 Top/bottom heating eco	30-300 °C	For gentle cooking of selected dishes on one level. The heat is emitted from above and below.
 Hot air grilling	30-300 °C	For roasting poultry, whole fish and larger pieces of meat. The grill heating element and the fan switch on and off alternately. The fan circulates the hot air around the food.
 Grill, large area	Grill settings: 1 = low 2 = medium 3 = high	For grilling flat items such as steaks, sausages or bread, and for browning food. The whole area of the grill heating element becomes hot.



	Grill, small area	Grill settings: 1 = low 2 = medium 3 = high	For grilling small quantities of food such as steaks, sausages or bread, and for browning food. The centre part under the grill heating element becomes hot.
	Pizza setting	30-275 °C	For preparing pizza and dishes which require a lot of heat from underneath. The bottom heating element and the ring heating element in the back panel heat up.
	Slow cooking	70-120 °C	For gentle and slow cooking of seared, tender pieces of meat in ovenware without a lid. The heat is emitted evenly from the top and bottom at low temperatures.
	Bottom heating	30-250 °C	For cooking in a bain marie and for the final baking stage. The heat is emitted from below.
	Keeping warm	60-100 °C	For keeping cooked food warm.
	Preheating ovenware	30-70 °C	For preheating ovenware.
	CoolStart function	30-275 °C	For the quick preparation of frozen products on level 3. The temperature depends on the manufacturer's instructions. Use the highest temperature specified on the packaging. The cooking time is as specified or shorter. Preheating is not required.

Default values

For each type of heating, the appliance specifies a default temperature or level. You can accept this value or change it in the appropriate area.

Steam

To make sure you always use the right type of heating to steam your food, we have explained the differences and applications below.

Type of heating	Temperature	Use
 Reheating	80-180 °C	For gently heating food up and for crisping up pastries. The steam ensures that the food does not dry out.
 Dough proving	30-50 °C	For proving yeast dough and sourdough and for culturing yogurt. Dough will prove more quickly than at room temperature. The surface of the dough will not dry out.

Further information

In most cases, the appliance provides notes and further information on the action just carried out. To do this, press the  button. The note is shown for a few seconds.

Some notes are displayed automatically, for example as confirmation, or to provide an instruction or warning.

Cooking compartment functions

Some functions make your appliance easier to use. This, for example, enables the cooking compartment to be well lit and a cooling fan to prevent the appliance from overheating.

Opening the appliance door

If you open the appliance door during an operation, the operation is paused. Operation continues to run when you close the door.

Interior lighting

When you open the appliance door, the interior lighting switches on. If the door remains open for longer than 15 minutes, the lighting switches off again.

For most operating modes, the interior lighting switches on as soon as the operation is started. When the operation has finished, the lighting switches off.

Note: You can set the interior lighting not to come on during the operation in the basic settings.

Cooling fan

The cooling fan switches on and off as required. The hot air escapes above the door.

Caution!

Do not cover the ventilation slots. Otherwise the oven will overheat.

So that the cooking compartment cools down more quickly after operation, the cooling fan continues to run for a certain period afterwards.

Note: You can change how long the cooling fan continues to run for in the basic settings. → "Basic settings" on page 18

Water tank

The appliance is fitted with a water tank. The water tank is behind the panel. For operations with steam, fill the water tank with water. → "Steam" on page 19

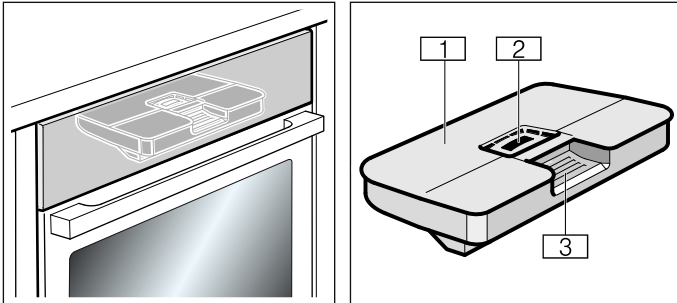

- 1 Tank cover
- 2 Filling opening
- 3 Handle for removing and inserting the water tank

Accessories

Your appliance is accompanied by a range of accessories. Here, you can find an overview of the accessories included and information on how to use them correctly.

Accessories included

Your appliance is equipped with the following accessories:

	<p>Wire rack For ovenware, cake tins and ovenproof dishes. For roasts, grilled items and frozen meals.</p>
	<p>Universal pan For moist cakes, pastries, frozen meals and large roasts. It can be used to catch dripping fat when you are grilling directly on the wire rack.</p>

Only use genuine accessories. They are specially adapted for your appliance.

You can buy accessories from the after-sales service, from specialist retailers or online.

Note: The accessories may become deformed when they become hot. This does not affect their function. Once they cool down again, they regain their original shape.

Inserting accessories

The cooking compartment has five shelf positions. The shelf positions are counted from the bottom up.

In some appliances, the highest shelf position is marked on the cooking compartment with the grill symbol.

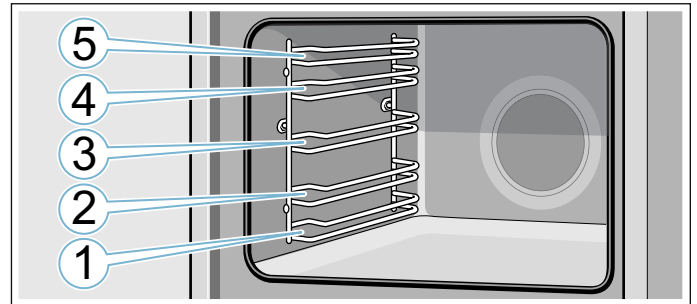

Always insert the accessory between the two guide bars for a shelf position.

Accessories can be pulled out approximately halfway without tipping.

Notes

- Make sure that you always insert the accessories into the cooking compartment the right way round.
- Always insert accessories fully into the cooking compartment so that they do not touch the appliance door.
- Take any accessories that you will not be using out of the cooking compartment.

Locking function

The accessories can be pulled out approximately halfway until they lock in place. The locking function prevents the accessories from tilting when they are pulled out. The accessories must be inserted into the cooking compartment correctly for the tilt protection to work properly.

When inserting the wire rack, ensure that lug **a** is at the rear and is facing downwards. The open side must be facing the appliance door and the outer rail must be facing downwards.

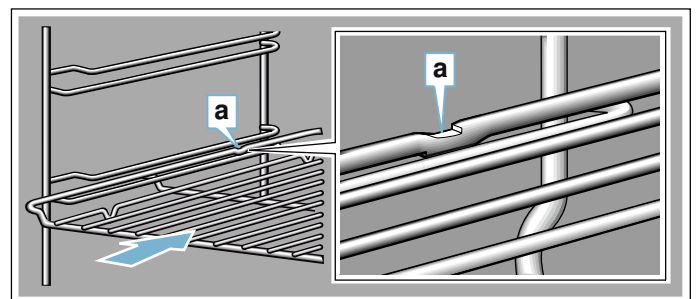

When inserting baking trays, ensure that lug **a** is at the rear and is facing downwards. The sloping edge of the accessory **b** must be facing towards the appliance door.

Example in the picture: Universal pan

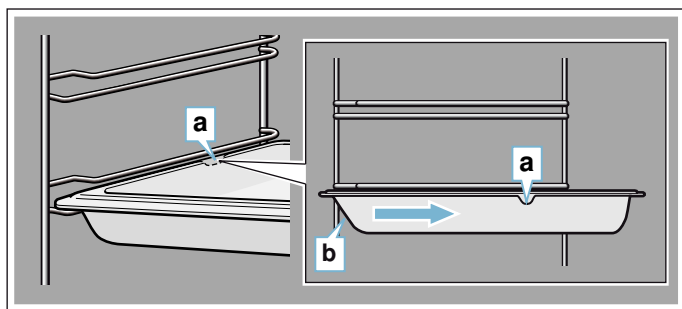

Combining accessories

You can insert the wire rack and the universal pan at the same time to catch drops of liquid.

When inserting the wire rack, ensure that both spacers **a** are at the rear edge. When inserting the universal pan, the wire rack is on top of the upper guide rod of the shelf position.

Example in the picture: Universal pan

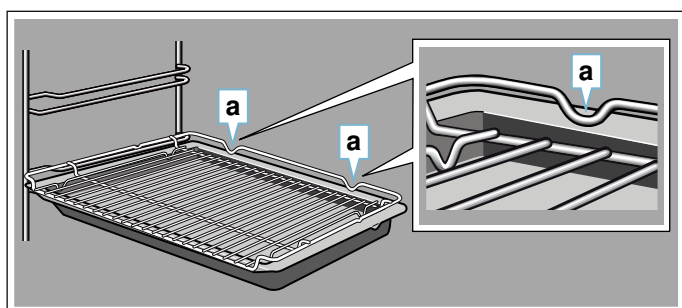

Optional accessories

You can buy optional accessories from the after-sales service, from specialist retailers or online. *You will find a comprehensive range of products for your appliance in our brochures and online.

Both availability and whether it is possible to order online differ between countries. Please see your sales brochures for more details.

Note: Not all optional accessories are suitable for every appliance. When purchasing, please always quote the exact identification number (E-no.) of your appliance.

→ "Customer service" on page 33

Optional accessories

Wire rack

For ovenware, cake tins and ovenproof dishes, and for roasts and grilled food.

Universal pan, Self-cleaning

For moist cakes, pastries, frozen meals and large roasts. It can be used to catch dripping fat when you are grilling directly on the wire rack.

Baking tray, Self-cleaning

For tray bakes and small baked products.

Wire insert

For meat, poultry and fish. For inserting into the universal pan to catch dripping fat and meat juices.

Profi pan

For preparing large quantities.

Lid for the Profi pan

The lid turns the Profi pan into a Profi roasting dish.

Pizza tray

For pizzas and large round cakes.

Grill tray, Self-cleaning

Use for grilling in place of the wire rack or as a splatter guard. Only use in the universal pan.

Bread-baking stone, Self-cleaning

For home-made bread, bread rolls and pizzas that require a crispy base.

The baking stone must be preheated to the recommended temperature.

Glass roasting dish

For stews and bakes.

Particularly suitable for the "Meals" operating mode.

Glass tray

For large roasts, moist cakes and bakes.

Glass tray

For bakes, vegetable dishes and baked goods.

Pull-out system, 1 level, Self-cleaning

The pull-out rails at level 2 allow you to pull the accessories out further without them tipping.

Pull-out system, 2 levels, Self-cleaning

The pull-out rails at levels 2 and 3 allow you to pull the accessories out further without them tipping.

Pull-out system, 3 levels, Self-cleaning

The pull-out rails at levels 1, 2 and 3 allow you to pull the accessories out further without them tipping.

Decorative trims

For concealing the lower shelf of the unit and the base of the appliance.



Before using for the first time

Before you can use your new appliance, you must make some settings. You must also clean the cooking compartment and accessories.

Before using for the first time

Before using the appliance for the first time, enquire about the water hardness of your tap water from your water supplier.

So that the appliance can reliably remind you to decalcify it when required, you must correctly set your water hardness range.

Caution!

The appliance may become damaged due to the use of unsuitable liquids.

Do not use distilled water, highly chlorinated tap water (>40 mg/l) or other liquids.

Only use cold, fresh tap water, softened water or non-carbonated mineral water.

Notes

- If your water is very hard, we recommend that you use softened water.
- If you only use softened water, you can set the water hardness range to "softened" in this case.
- If you use mineral water, set the water hardness range to "4 very hard".
- If you use mineral water, you must only use non-carbonated mineral water.

Water hardness range	Setting
0	0 softened
1 (up to 1.3 mmol/l)	1 soft
2 (1.3 - 2.5 mmol/l)	2 medium
3 (2.5 - 3.8 mmol/l)	3 hard
4 (above 3.8 mmol/l)	4 very hard

Initial use

After connecting the appliance to the power or following a power cut, the settings for initial use are shown in the display.

Note: You can change these settings at any time in the basic settings. → "Basic settings" on page 18

Setting the language

German is the preset language.

1. Use the rotary selector to select the required language.
2. Touch the √ arrow.
The next setting appears.

Setting the clock

The time starts at 12:00.

1. Use the rotary selector to set the current time.

2. Touch the √ arrow

Setting the date

The default date is 1.1.2014.

1. Always touch the √ arrow to move to the next setting.
2. Use the rotary selector to set the current day, month and year.

Setting the water hardness

The default water hardness setting is "very hard".

Change this setting if your water is softer. You can ask your water supplier about the water hardness level.

1. Set the hardness using the rotary selector.
2. Touch the √ arrow.
A message appears on the display confirming that the initial use has been completed.

With HomeConnect

1. Touch "Set using the assistant".
2. Further instructions can be found in section → "Home Connect" on page 24

Cleaning the cooking compartment

To remove the new-appliance smell, heat up the cooking compartment when it is empty and with the oven door closed.

1. Remove the accessories from the cooking compartment.
2. Remove leftover packaging, such as polystyrene pellets, from the cooking compartment.
3. Before heating the appliance, wipe the smooth surfaces in the cooking compartment with a soft, wet cloth.
4. Press the On/Off button to switch on the appliance.
5. Fill the water tank.
6. Set the type of heating, temperature and added steam, then start the appliance operation.

Settings

Type of heating	<input type="checkbox"/> Top/bottom heating with added steam ("low" intensity)
Temperature	240 °C
Duration	1 hour

7. Keep the kitchen ventilated while the appliance is heating up.
8. Use the On/Off touch button to switch off the appliance after the indicated time.
9. Wait until the cooking compartment has cooled down.
10. Clean the smooth surfaces with soapy water and a dish cloth.
11. Empty the water tank and dry the cooking compartment.

Cleaning the accessories

Clean the accessories thoroughly using soapy water and a dish cloth or soft brush.

Operating the appliance

You have already learnt about the controls and how they work. Now we will explain how to set your appliance. You will learn about what happens when you switch the appliance on and off, and how to select the operating mode.

Switching the appliance on and off

Before you are able to set the appliance, you must switch it on.

Exception: The childproof lock and the timer can be set when the appliance is switched off.

Displays or information, e.g the residual heat indicator in the cooking compartment, remain visible in the display after the appliance has been switched off.

Switch off your appliance when you do not need to use it. If no settings are applied for a long time, the appliance switches itself off automatically.

Switching the appliance on

Use the On/Off button to switch the appliance on. The on/off symbol above the button is illuminated in blue.

The Siemens logo appears in the display, and then a type of heating and a temperature.

Note: You can specify which operating modes should appear after the appliance is switched on in the basic settings.

Switching off the appliance

Use the On/Off button to switch off the appliance. The lighting above the button goes out.

A set function is cancelled.

The time appears in the display.

Note: You can set whether or not the time should be displayed when the appliance is switched off in the basic settings.

Starting or interrupting operation

To start operation or to interrupt an operation which has started running, press the Start/Stop button. The cooling fan may continue to run after an operation is interrupted.

Press the On/Off button to delete all settings.

If you open the cooking compartment door during operation, operation is interrupted. Close the cooking compartment door to continue operation.

Selecting an operating mode

When you select an operating mode, the appliance must be switched on.

1. Press the menu button.
The operating modes menu opens.
2. Touch the required operating mode.
Depending on the operating mode, different options are available.
3. Use the rotary selector to change the selection.
Depending on the selection, change further settings.
4. Use the start/stop button to start.
The elapsed time appears in the display. The settings and progress line can be seen.

Setting the type of heating and temperature

After the appliance is switched on, the set suggested type of heating appears with the temperature. You can start this setting immediately with the Start/Stop button. If you want to set another type of heating, proceed as follows.

For other settings, you can change the values as follows:

Example in the picture: Top/bottom heating at 180 °C.

1. Use the rotary selector to change the type of heating.

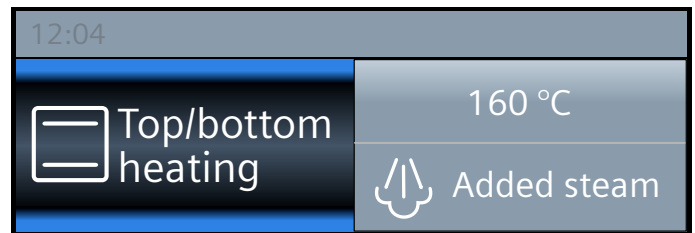

2. Touch the suggested temperature.
3. Use the rotary selector to change the temperature.

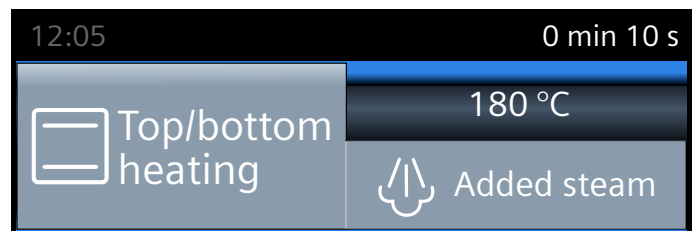

4. Press the Start/Stop button to start.

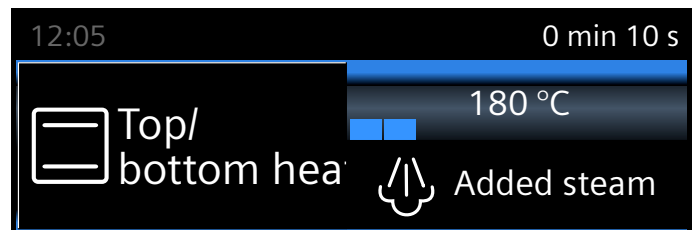



The set type of heating and the temperature are shown on the display.

Rapid heat up

You can use the »»» button to heat up the cooking compartment particularly quickly. The rapid heat up function is not possible for all types of heating.

Suitable types of heating:

	4D hot air
	Top/bottom heating

To ensure an even cooking result, do not place your food and the accessory in the cooking compartment until rapid heating is complete.

Making settings

Ensure you have selected a suitable type of heating. The temperature must be set to above 100 °C, otherwise the rapid heating function cannot be started.

1. Set the type of heating and temperature.
2. Press the »»» button.

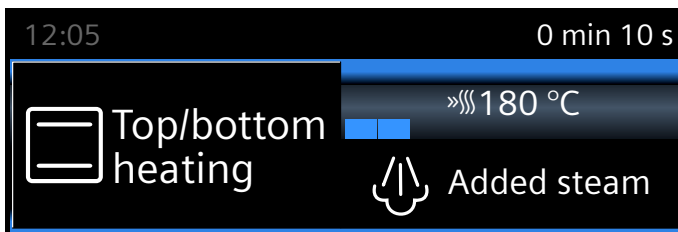

The »»» symbol appears on the left next to the temperature. The temperature indicator starts to fill in.

When rapid heating is complete, a signal sounds. The »»» symbol goes out. Place your dish in the cooking compartment.

Notes



- If you change the type of heating or the temperature, the rapid heating function is cancelled.
- If a duration has been set, this runs independently of rapid heating and counts down immediately when the operation is started.
- You can use the  button to check the current cooking compartment temperature during rapid heating.

Cancelling

Press the »»» button. The »»» symbol disappears from the display.

Time-setting options

Your appliance has different time-setting options.

Time-setting option	Use
 Timer	The timer functions like an egg timer. An audible signal sounds once the set time has elapsed.
 Cooking time	A signal sounds once a set cooking time has elapsed. The appliance switches off automatically.
 End	Set a cooking time and an end time. The appliance switches on automatically so that the operation ends at the desired time.

Notes

- A cooking time of up to one hour can be set exactly to the minute. A cooking time of over one hour can be set in 5-minute increments.
- Depending on which direction you turn the rotary selector, the cooking time starts at a default value: Anti-clockwise, 10 minutes, Clockwise, 30 minutes.
- After a time-setting option has elapsed, a signal sounds.
- Using the  button, you can request information during operation, which then appears briefly in the display.

Timer

You can set the timer at any time, even if the appliance is switched off. It runs parallel to the other time settings and has a separate audible signal. In this way, you can tell whether it is the timer or a cooking time which has elapsed.

The maximum setting you can apply is 24 hours.



1. Press the  button. The field for the timer opens.
2. Use the rotary selector to set the timer duration. The timer starts after a few seconds.

The  symbol for the timer and the time counting down are displayed on the left in the status bar.



When the time has elapsed

An audible signal sounds. "Timer elapsed" appears in the display. Use the  button to cancel the audible signal early.

Cancelling the timer duration

Press the  button to open the time-setting options menu and turn the time back. Press the  button to close the menu.

Changing the timer duration

Use the  button to open the time-setting options menu and change the timer time in the next few seconds using the rotary selector. Start the timer with the  button.

Cooking time

If you set the cooking time for your meal, the operation stops automatically once this time has elapsed. The oven stops heating.

Prerequisite: A type of heating and a temperature have been set.

For example: Setting for 4D hot air, 180 °C, cooking time 45 minutes.

1. Press the  button.
The time-setting options menu opens.

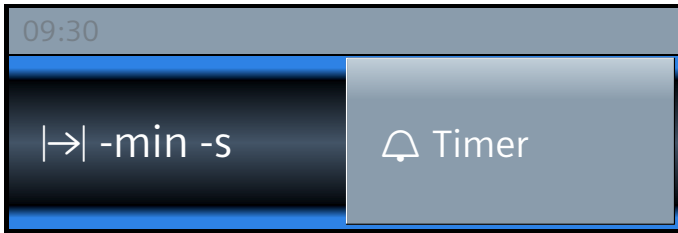

2. Set the cooking time using the rotary selector.

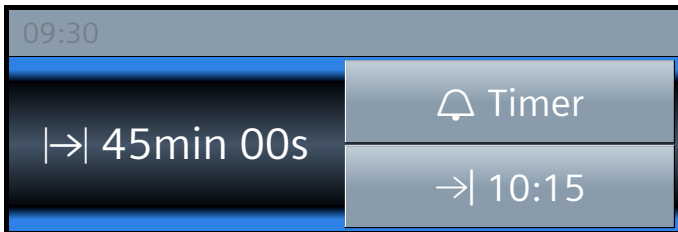

3. Press the Start/Stop button to start.
You can see the  cooking time counting down in the status bar.

The cooking time has elapsed

A signal sounds. The oven stops heating. "Finished" appears in the status bar. You can cancel the audible signal early using the  button.

Cancelling the cooking time

Press the  button to open the time-setting options menu. Turn the time back. The type of heating and temperature set are shown in the display.

Changing the cooking time

Press the  button to open the time-setting options menu. Change the cooking time using the rotary selector.

End time

If you change the end time, please remember that easily spoiled foods must not be allowed to remain in the cooking compartment for too long.

Prerequisite: The selected operation has not already begun. A cooking time has been set. The time-setting options menu  is open.

Example in the picture: You put the dish in the cooking compartment at 9:30. It takes 45 minutes to cook and will be ready at 10:15, but you would like it to be ready at 12:45 instead.

1. Touch the "End " field.
The end time is displayed.

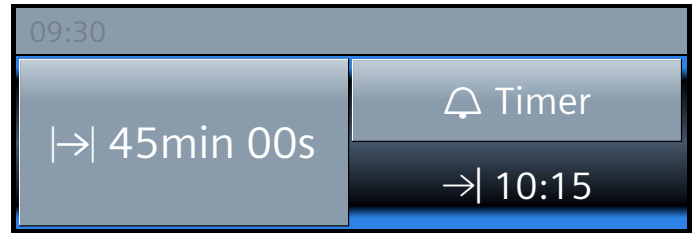

2. Using the rotary selector, set a later end time.

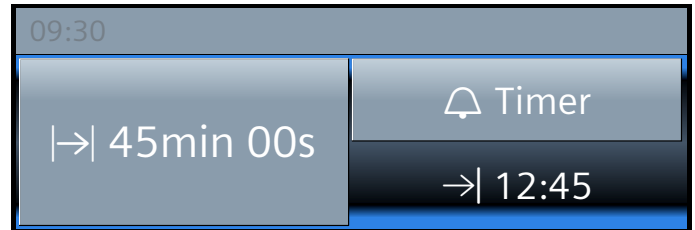

3. Confirm with the Start/Stop button.

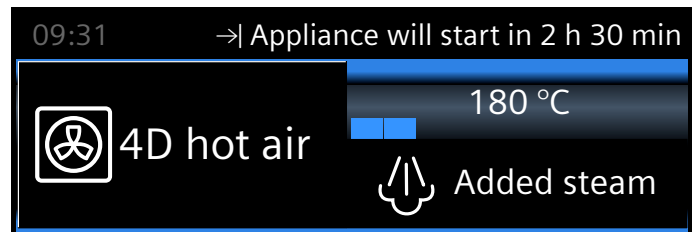



The oven is in standby. The  symbol and the time when the operation will be finished appear in the status bar. The operation starts at the appropriate time. You can see the cooking time counting down in the status bar.



The cooking time has elapsed

A signal sounds. The oven stops heating. "Finished" appears in the status bar. You can cancel the audible signal early using the  button.

Correcting the end time

This is possible if the oven is in standby. Use the  button to open the time-setting options menu, touch "End " and use the rotary selector to correct the end time. Press the  button to close the menu.

Cancelling the end time



This is possible if the oven is on standby. To do so, open the time-setting options menu using the  button. Touch "End " and reset the End time using the rotary selector. The cooking time immediately starts to count down.

Childproof lock

Your appliance is equipped with a childproof lock so that children cannot switch it on accidentally or change any settings.

Activating and deactivating

You can activate and deactivate the childproof lock when the appliance is switched on or off.

In each case, press the  button for approx. 4 seconds. A confirmation note appears in the display and the  symbol appears in the status bar.

The appliance door is locked



In the basic settings, you can change the settings so that the appliance door is also locked in addition to the control panel.

The appliance door locks if the temperature in the cooking compartment reaches approx. 50 °C. The  symbol is displayed in the status bar. When the oven is switched off, the appliance door locks immediately if the childproof lock has been activated.

Basic settings

There are various settings available to you in order to help use your appliance effectively and simply. You can change these settings as required.

Changing settings

1. Press the On/Off button.
2. Press the menu button.
The operating modes menu opens.
3. Select the "Settings" operating mode.
The first basic setting appears and can be changed using the rotary selector.
4. Touch the  arrow.
5. Use the rotary selector to change the values.
6. Use the  arrow to switch to the next basic settings.
7. Press the menu button to save.
"Save" or "Discard" appears on the display.

List of settings

This list tells you all the basic settings and how to change them. Depending on the model of the appliance you own, the display will show only those settings that apply to your appliance.

You can change the following settings:

Setting	Options
Select language	Additional languages possible
Time of day	Sets the current time
Date	Sets the current date

Water hardness	0 (softened)
	1 (soft)
	2 (medium)
	3 (hard)
Audible signal duration	4 (very hard)
	Short (30 s)
	Medium (1 m)
Button tone	Long (5 m)
	Switched off (button tone still sounds when switching on/off using the "On/off" button)
Display brightness	Switched on
	Can be adjusted to one of five different levels
Clock display	Digital with date
	Analogue
	Off
Lighting	On during operation
	Off during operation
Childproof lock*	Door lock + button lock
	Button lock only
Operation after switching on	Main menu
	Heating modes
	Steaming
	Dishes*
Night-time dimming	Switched off
	Switched on (display dimmed between 10 p.m. and 5.59 a.m.)
Brand name logo	Display
	Do not display
Fan run-on time	Recommended
	Minimum
Pull-out system	Not retrofitted
	Retrofitted
Sabbath mode	Switched on
	Switched off
Home Connect	Switches Wi-Fi on or off → "Home Connect" on page 24
Factory settings	Restore
	Do not restore

*) Included, depending on appliance model

Caution!

For shelves and single rails: "Not retrofitted" setting.
For sets of two or three rails: "Retrofitted" setting.

Note: Changes to the language, button tone and display brightness settings take effect immediately. All other changes take effect after the settings have been saved.

Changing the time

You can change the time in the basic settings.
For example: Changing from summer to winter time.

1. Press the On/Off button.
2. Press the menu button.
The operating modes menu opens.
3. Touch "Settings".
4. Use the > arrow to switch to "Clock".
5. Use the rotary selector to change the time.
6. Press the menu button.
"Save" or "Discard" appears on the display.

Power cut

Following a long power cut, the settings for initial use are shown in the display.

Reset the language, time and date.

Steam

With some types of heating, you can prepare food with steam assistance. In addition, the Dough proving and Reheating types of heating are available.

Warning – Risk of scalding!

When you open the appliance door, hot steam can escape. Steam may not be visible, depending on its temperature. When opening, do not stand too close to the appliance. Open the appliance door carefully. Keep children away.

Noise

Pump

You will hear a humming noise while the pump is in operation and after switching it off. This noise is caused by the pump function test. It is a normal operating noise.

Control panel

You will hear a humming or clicking noise when opening the control panel. These noises are caused by the control panel being pushed out. They are normal operating noises.

Steam-assisted cooking

When you cook with steam assistance, steam is introduced into the cooking compartment at various intervals and with varying degrees of intensity. This gives you a better cooking result.

Your food

- Becomes crispy on the outside
- Develops a shiny surface
- Is succulent and tender on the inside
- Only undergoes a minimum reduction in volume

You set the type of heating and steam intensity combination that you want. Use the information in the

tables to select a suitable type of heating and steam intensity, or select a programme.





Steam intensity

Different intensity levels are available when adding steam:

- Low
- Medium
- High

Suitable types of heating

You can switch on steam assistance for these types of heating:

- 4D hot air 
- Top/bottom heating 
- Hot air grilling 
- Keeping warm 

Starting

1. Fill the water tank.
2. Set the type of heating using the rotary selector.
3. Touch the "Temperature" field and set the temperature using the rotary selector.
4. Touch the "Added steam" field and set the steam intensity using the rotary selector.
5. Press the Start/Stop button to start.
The appliance heats up.

Note: If the water tank runs dry during a steam operation, a message appears on the display prompting you to fill up the water tank. The operation continues without adding steam.

Cancelling steam addition

To switch off steam assistance early, touch the "Added steam" field. Use the rotary selector to set to "Off".

Note: The operation continues without adding steam.

Cancelling appliance operation

Touch the Start/Stop button to cancel the operation.

Finishing

Touch the On/Off button to switch off the appliance.

Reheating

With the "Reheating 

" type of heating, you can gently reheat food that has already been cooked or crisp up day-old baked goods. Steam is switched on automatically.

Note: If the water tank runs dry during the operation with the Reheating setting, the operation is interrupted. Fill the water tank.

Starting

1. Fill the water tank.
2. Touch the Menu button.
3. Touch the "Steaming" field.
4. Use the rotary selector to set to "Reheating ".
5. Touch the "Temperature" field and set the temperature using the rotary selector.

6. Touch the "Duration" field and set the duration using the rotary selector.
7. Press the Start/Stop button to start.
The appliance heats up.

A signal sounds. The oven stops heating. You can cancel the audible signal early using the ⏸ button.

Cancelling

Touch the Start/Stop button to cancel the operation.

Finishing

Touch the On/Off button to switch off the appliance.

Prove dough

Dough will prove considerably more quickly using the "Dough proving"  type of heating than at room temperature and does not dry out.

Use the information in the tables to select the appropriate setting. → "Tested for you in our cooking studio" on page 35

Note: If the water tank runs dry during the operation with the Dough proving setting, the operation is interrupted. Fill the water tank.

Starting

1. Fill the water tank.
Note: Only switch on Dough proving once the cooking compartment has completely cooled down (to room temperature).
2. Touch the Menu button.
3. Touch the "Steaming" field.
4. Use the rotary selector to set to "Dough proving" .
5. Touch the "Temperature" field and set the temperature using the rotary selector.
6. Touch the "Duration" field and set the duration using the rotary selector.
7. Press the Start/Stop button to start.
The appliance heats up.

A signal sounds. The oven stops heating. You can cancel the audible signal early using the ⏸ button.

Cancelling

Touch the Start/Stop button to cancel the operation.

Finishing

Touch the On/Off button to switch off the appliance.

Filling the water tank

The water tank is located behind the control panel. Before starting an operation with steam, open the control panel and fill the water tank with water.

Make sure that you have set the water hardness range correctly. → "Basic settings" on page 18

Warning – Risk of injury and risk of fire!

Only fill the water tank with water or with the descaling solution that is recommended by us. Do not pour any flammable liquids (e.g. alcoholic drinks) into the water tank. Due to hot surfaces, vapours from flammable

liquids may catch fire in the cooking compartment (explosion). The appliance door may spring open. Hot steam and jets of flame may escape.

Warning – Risk of burns!

The water tank may heat up while the appliance is in operation. Wait until the water tank has cooled down after the previous appliance operation. Remove the water tank from the water tank recess.

Caution!

The appliance may become damaged due to the use of unsuitable liquids. Do not use distilled water, highly chlorinated tap water (> 40 mg/l) or other liquids. Only use cold, fresh tap water, softened water or uncarbonated mineral water.

Notes

- If your water is very hard, we recommend that you use softened water.
 - If you use only softened water, you can set your appliance to the "softened" water hardness range.
 - If you use mineral water, set the water hardness range to "4 very hard".
 - If you use mineral water, you must only use non-carbonated mineral water.
1. Touch the  field.
The control panel is automatically pushed forwards.
 2. Pull the control panel forwards with both hands and then push it upwards until it locks into place (Fig. **1**).
 3. Lift the water tank and remove it from the water tank recess (Fig. **2**).

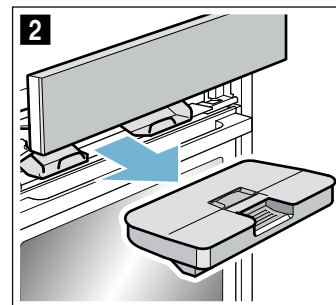
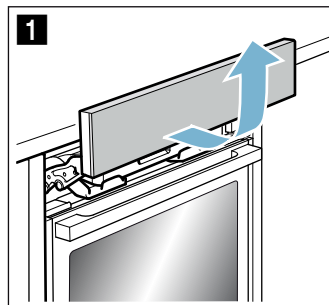

4. Press down on the lid along the seal to prevent water from leaking out of the water tank.
5. Remove the cover **a** (Fig. **3**).
6. Fill the water tank with cold water up to the "max." mark (Fig. **4**).

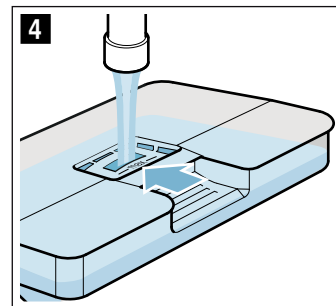
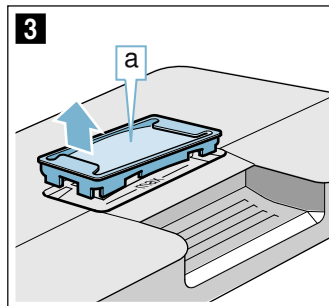

7. Reinsert the cover **a** into the opening in the water tank.
8. Insert the filled water tank (Fig. **5**). Ensure that the water tank locks into place behind both holders **b** (Fig. **6**).

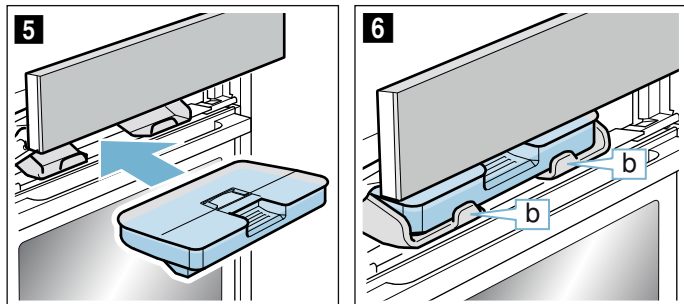

9. Slowly push the control panel downwards and then towards the rear until it is closed completely. The water tank has been filled. You can start operations with steam.

Refilling the water tank

Notes

- Steam-assisted operations continue without adding steam.
- If the water tank runs dry during the operation with the Dough proving or Reheating setting, the operation is interrupted. Fill the water tank.

1. Open the control panel.
2. Remove and refill the water tank.
3. Insert the filled water tank and close the control panel.

After every steam operation

⚠ Warning – Risk of scalding!

When you open the appliance door, hot steam can escape. Steam may not be visible, depending on its temperature. When opening, do not stand too close to the appliance. Open the appliance door carefully. Keep children away.

⚠ Warning – Risk of burns!

The appliance becomes hot during operation. Allow the appliance to cool down before cleaning.

Caution!

Enamel damage: Do not start any operations when there is water on the cooking compartment floor. Before operation, wipe away the water from the cooking compartment floor.

The remaining water is pumped back into the water tank after every operation with steam. Then empty and dry the water tank. Moisture remains in the cooking compartment. To dry the cooking compartment, you can either use the "Drying function" operating mode or dry the cooking compartment by hand.

Notes

- Once the appliance has been switched off, the  field remains lit for a little longer to remind you to empty the water tank.

- Remove limescale marks with a cloth soaked in vinegar, then wipe with clean water and dry with a soft cloth.

Emptying the water tank

Caution!

- Do not dry the water tank in the hot cooking compartment. This will damage the water tank.
- Do not clean the water tank in the dishwasher. This will damage the water tank.

1. Open the control panel.
2. Remove water tank.
3. Carefully remove the lid of the water tank.
4. Empty the water tank, clean it with detergent and then rinse it thoroughly with clean water.
5. Dry all parts with a soft cloth.
6. Rub the seal on the lid until dry.
7. Leave to dry with the lid open.
8. Place the lid on the water tank and push it down.
9. Insert the water tank and close the control panel.

Cleaning the drip trough

1. Allow the appliance to cool down.
2. Open the appliance door.
3. Soak up the water in the drip trough **a** with a sponge cloth and wipe it carefully (figure **1**).

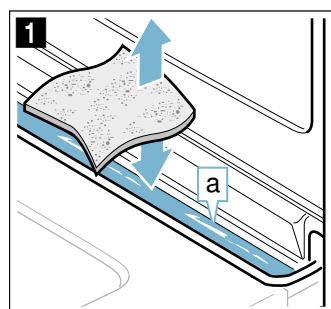

The drip trough **a** is located below the cooking compartment (figure **2**).

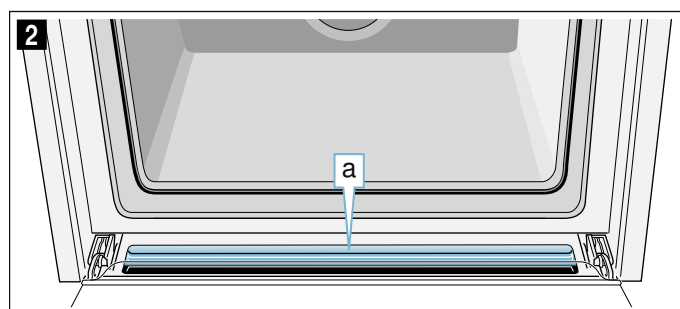

Starting the Drying function

To dry the cooking compartment, it is heated up so that the moisture in the cooking compartment evaporates. You will then need to open the appliance door to allow the steam to escape from the cooking compartment.

Caution!

Enamel damage: Do not start any operations when there is water on the cooking compartment floor. Before operation, wipe away the water from the cooking compartment floor.

1. Leave the appliance to cool down.

- Remove the worst dirt from the cooking compartment immediately and wipe away moisture from the cooking compartment floor.
- If necessary, press the On/Off button to switch on the appliance.
- Press the menu button.
The options for selecting an operating mode are displayed.
- Touch the "Next" field.
- Touch the "Drying" field.
- Press the Start/Stop button.
The drying function starts and ends automatically after 10 minutes.
- Open the appliance door and leave it open for 1 to 2 minutes so that the moisture in the cooking compartment can escape.

Drying the cooking compartment by hand

- Allow the appliance to cool down.
- Remove any food remnants from the walls of the cooking compartment.
- Dry the cooking compartment with a sponge.
- Leave the appliance door open for 1 hour so that the cooking compartment dries completely.



Sabbath mode

With the Sabbath mode, a cooking time of up to 74 hours can be set. You can keep the food in the cooking compartment warm without having to switch the oven on or off.

Starting Sabbath mode

Prerequisite: "Sabbath mode activated" is activated in the basic settings. → *"Basic settings" on page 18*

The cooking compartment heats up with top/bottom heating and a temperature between 85 °C and 140 °C.

- Press the On/Off button.
A type of heating and a temperature are suggested in the display.
- Turn the rotary selector anti-clockwise and select the "Sabbath mode" type of heating.
- Touch the suggested temperature and set the temperature using the rotary selector.
- Press the  button to open the time-setting options menu and touch the "Cooking time" field.
25:00 hours are suggested.
- Use the rotary selector to set the required cooking time.
- Press the Start/Stop button to start.
You can see the cooking time counting down in the status bar.

The cooking time has elapsed

A signal sounds. The oven stops heating. "Finished" appears in the status bar.

Setting a later end time

It is not possible to set a later end time.

Cancelling Sabbath mode

Press the On/Off button. All settings are deleted. You can apply new settings.



Cleaning function

Your appliance is equipped with the "Self-cleaning" and "Descaling" operating modes. You can use the "Self-cleaning" operating mode to clean the cooking compartment effortlessly. You can use the "Descaling" operating mode to remove limescale from the evaporator.

Self-cleaning

The cooking compartment is heated up to a very high temperature. Residues from roasting, grilling and baking will burn.

You can choose from three cleaning settings.

Setting	Cleaning level	Duration
1	Light	Approx. 1 hour, 15 minutes
2	Medium	Approx. 1 hour, 30 minutes
3	Intensive	Approx. 2 hours

The dirtier the cooking compartment and the longer the dirt has been there, the higher the cleaning setting should be. A cleaning cycle requires only approx. 2.5 – 4.7 kilowatt hours.

Note: For your safety, the cooking compartment door locks automatically. It cannot be opened again until the  symbol for the locking mechanism goes out in the status bar. The interior lighting remains off during cleaning.

Warning

Risk of burns!

- The cooking compartment becomes extremely hot during the cleaning function. Never open the appliance door. Allow the appliance to cool down. Keep children away from the appliance.
-  The appliance will become very hot on the outside during the cleaning function. Never touch the appliance door. Allow the appliance to cool down. Keep children away from the appliance.

Prior to initiating the cleaning function

Caution!

Before cleaning is started, remove the water tank from the appliance. → *"Steam" on page 19*

When using the cleaning function, you can clean an accessory at the same time, e.g. the universal pan or the baking tray. Before cleaning is started, remove the worst dirt. Slide the accessory in at level 2.

Clean the inside of the appliance door and along the surface edges of the cooking compartment in the area around the seal. Do not scrub the seal, do not remove!

Note: When using the cleaning function, you can clean the enamel accessory provided at the same time. You cannot clean any of the wire racks when using the cleaning function. The wire racks are not suitable for cleaning using the cleaning function; this will discolour them. Further accessories suitable for cleaning using the cleaning function are listed in the table for special accessories. → "Accessories" on page 12

Warning **Risk of fire!**

- Loose food residues, grease and meat juices may catch fire during the cleaning function. Before starting the cleaning function, remove coarse dirt from the cooking compartment and from the accessories.
- The appliance will become very hot on the outside during the cleaning function. Never hang combustible objects, e.g. tea towels, on the door handle. Do not place anything against the front of the appliance. Keep children away from the appliance.



Warning – Risk of serious damage to health!

The appliance will become very hot during the cleaning function. The non-stick coating on baking trays and tins is destroyed and noxious gases are released. Never clean non-stick baking trays and baking tins using the cleaning function. Only clean enamelled accessories using the cleaning function.

Setting the self-cleaning function

1. Press the menu button.
The operating modes menu opens.
2. Select the "Self-cleaning" operating mode.
Cleaning setting 3 is suggested. You can start the cleaning process immediately using the "Start/stop" button or
3. select a different cleaning setting using the rotary selector.
4. Press the "Start/stop" button to start the cleaning operation.

Ventilate the kitchen when the cleaning function is running.

The cooking compartment door locks shortly after operation starts. The  symbol for the locking mechanism appears on the right-hand side of the status bar next to the elapsing duration. The cooking compartment door cannot be opened until the  symbol goes out in the status bar.

Once the cleaning has finished

An audible signal sounds. The oven stops heating. "Finished" appears in the status bar. Use the  button to switch off the audible signal.

Cancelling the cleaning operation

Use the "On/off" button to switch off the oven. The cooking compartment door cannot be opened until the  symbol goes out in the status bar.

Adjusting the cleaning setting

Once cleaning starts, the cleaning setting can no longer be changed.

You can set the cleaning to run overnight

In the section "Time settings", you can find out how to delay the end time. This allows you to use the oven at any time throughout the day. → "Time-setting options" on page 16

Once the cleaning function has ended

Once the cooking compartment has cooled down, use a damp cloth to wipe off the ash that has been left behind in the cooking compartment and around the appliance door.

Note: Very bad soiling may cause white deposits to remain on the enamel surfaces. This is residue from the food and is harmless. It does not affect performance. You can remove these residues using lemon juice if required.

Descaling

The appliance must be descaled regularly in order for it to continue operating correctly.

There are several steps in the descaling programme. For hygiene reasons, the descaling programme must be run through completely so that the appliance can be ready for operation again. In total, the descaling programme runs for approx. 70-90 minutes.

- Descal (approx. 55-70 minutes), then empty and refill the water tank
- First rinsing cycle (approx. 6-9 minutes), then empty and refill the water tank
- Second rinsing cycle (approx. 6-9 minutes), then empty and dry the water tank

If the descaling process is interrupted (for example, due to a power failure or because the appliance has been switched off), you are prompted to rinse the appliance twice after it is switched back on. The appliance cannot be used until the second rinsing cycle has come to an end.

The frequency with which the appliance must be descaled depends on the hardness of the water used. When only five more steam-assisted operations are possible, or fewer, the appliance reminds you to descale it with a message on the display. The number of remaining operations is displayed after the appliance is switched on. You can therefore prepare for the descaling in good time.

Starting

Caution!

- Risk of damage to the appliance: Only use liquid descalers recommended by us for the descaling programme. The time the product needs to work during descaling depends on the type of descaler used. Other descalers may damage the appliance. Descaler order no. 311 680

- Descaling solution: Do not allow any descaling solution or descaler to come into contact with the control panel or other surfaces on the appliance. This damages the surfaces. If this does happen, remove the descaling solution immediately with water.

If you have used a steam-assisted operation immediately before descaling, you must first switch the appliance off so that the residual water is pumped out of the evaporator system.

1. Mix 400 ml water with 200 ml liquid descaler to make a descaling solution.
2. Press the On/Off button.
3. Remove the water tank and fill it with descaling solution.
4. Once the water tank has been filled with descaling solution, push it back in again fully.
5. Close the control panel.
6. Press the Menu button.
The operating modes menu opens.
7. Select the "Descaling" operating mode.
If you touch the "Next" field, information on the cleaning operation is displayed.
The duration of the descaling programme is displayed. It cannot be changed.
8. Press the "Start/stop" button to start the cleaning operation.
The appliance is descaled. You can see the duration counting down in the status bar. An audible signal sounds once descaling has finished.

First rinsing cycle

1. Open the control panel.
2. Remove the water tank, rinse thoroughly, fill with water and reinsert.
3. Close the control panel.
4. Press the Start/Stop button to start.
The appliance rinses. As soon as the rinsing cycle has run through, a signal sounds.

Second rinsing cycle

1. Open the control panel.
2. Remove the water tank, rinse thoroughly, fill with water and reinsert.
3. Close the control panel.
4. Press the Start/Stop button to start.
The appliance rinses. As soon as the rinsing cycle has run through, a signal sounds.

Final cleaning

1. Open the control panel.
2. Empty and dry the water tank.
3. Switch off the appliance.
Descaling is complete and the appliance is ready for use again.

Home Connect

This appliance is WiFi-capable and can be remotely controlled using a mobile device.

If the appliance is not connected to the home network, the appliance functions in the same way as an oven with no network connection and can still be operated via the display.

Notes

- Ensure that you follow the safety instructions in this instruction manual and that these are complied with even when operating the appliance via the Home Connect app and when you are away from home. Follow the instructions in the Home Connect app. → "Important safety information" on page 5
- Operation on the appliance always has priority. During this time, it is not possible to operate the appliance using the Home Connect app.

Setting up

To implement settings via Home Connect, you must have installed and set up the Home Connect app on your mobile device.

Observe the Home Connect documents supplied for this.

Follow the steps specified by the app to make the settings.

The app must be open in order to perform the setup process.

Automatic registration in the home network

Notes

- You require a router that has WPS functionality.
 - You can start the Home Connect Assistant during initial start-up or using the menu.
1. Press the menu button.
 2. Touch "Home Connect Assistant".
The appliance is ready to connect to the network automatically.

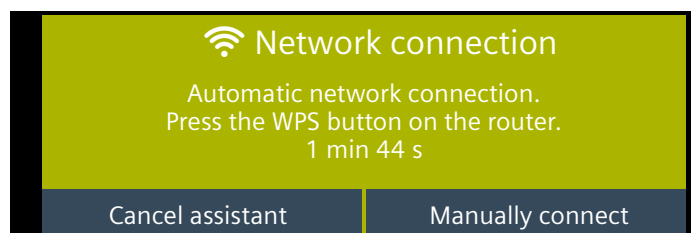

3. Press the WPS button on the router.
Wait until "Network connection successful" is shown on the display.

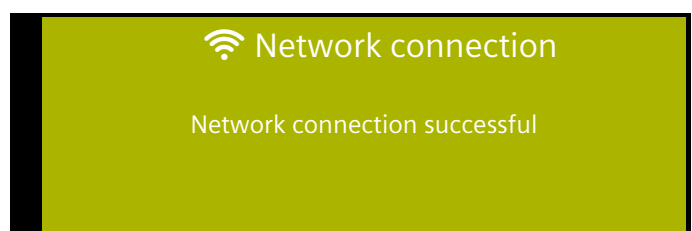

4. Touch "Connect to the app".

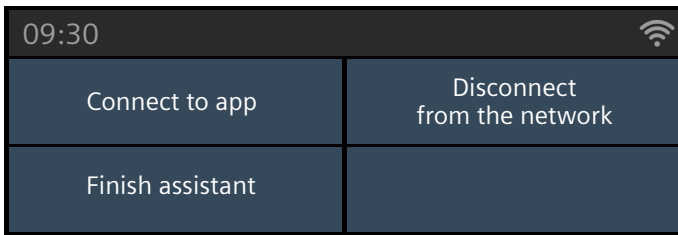

The appliance is ready to connect to the app.

5. Start the app on the mobile device and follow the instructions for automatic network registration. The process for registering is completed once "Successfully connected to the app" is shown on the display.

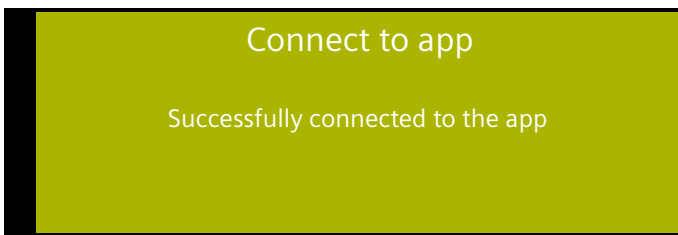

Manual registration in the home network

Note: You can start the Home Connect Assistant during initial start-up or using the menu.

1. Press the menu button.
2. Touch "Home Connect Assistant".
3. Touch "Connect manually".

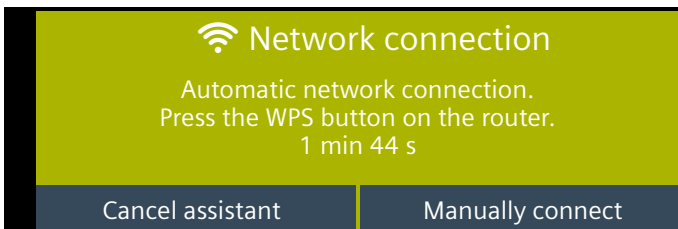

The appliance is ready to connect to the network manually.

The SSID and the key for the oven network are shown on the display.

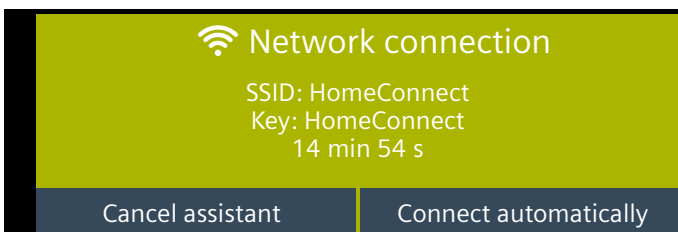

4. Use the "Home Connect" SSID and the "Home Connect" key to register the mobile device on the oven network.



Wait until "Network connection successful" is shown on the display.

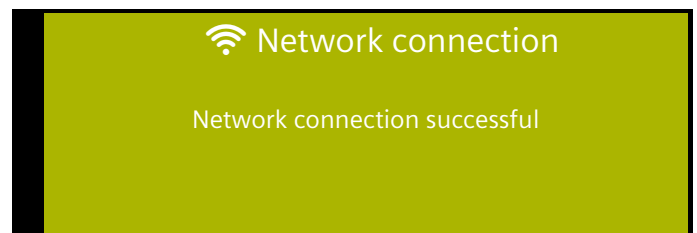

5. Touch "Connect to the app".

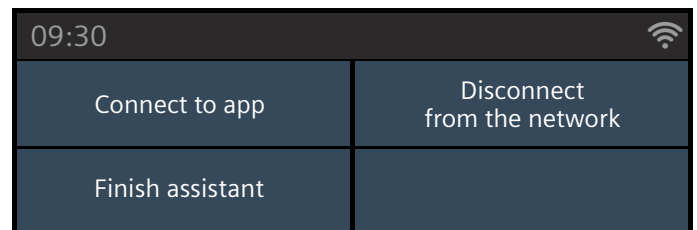

The appliance is ready to connect to the app.

6. Start the app on the mobile device and follow the instructions for manual network registration. The process for registering is completed once "Successfully connected to the app" is shown on the display.

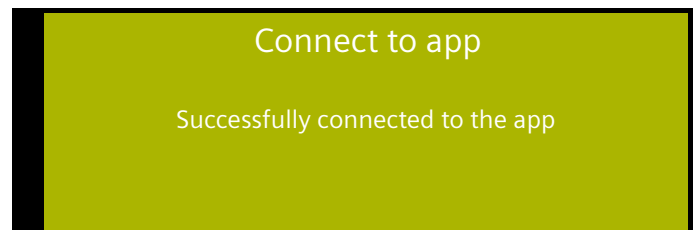

Remote Start

If you want to start an oven operation using your mobile device, you must activate remote start.

Notes

- "Remote start" is only visible if the Home Connect Assistant has been successfully completed.
- Note that some operating modes can only be started on the oven itself.

1. Press the menu button.
2. Touch "Remote Start".

☞ appears in the display

Remote start is automatically deactivated in the following situations:

- The oven door is opened 15 minutes after remote start is activated.
- The oven door is opened 15 minutes after the oven operation ends.
- 24 hours after remote start is activated.

When you start the oven operation on the appliance, remote start is automatically activated. You can therefore make changes on your mobile device or start a new programme.

Home Connect settings

You can adjust Home Connect to suit your requirements at any time.

Note: In the Home Connect settings, press the ⓘ button to display network and device information.

WiFi

If WiFi is activated, you can use the Home Connect functions.

Note: In the networked standby mode, your appliance requires a maximum of 3 W.

1. Press the menu button
2. Touch "Settings".
3. Touch the arrow > to switch to "Home Connect".
4. Touch "Home Connect settings".
5. Touch "WiFi" to switch the radio module on or off.



Disconnecting from the network

You can disconnect your oven from the network at any time.

Note: If your oven is disconnected from the network, it is not possible to operate the oven using Home Connect.

1. Press the menu button.
2. Touch "Settings".
3. Touch the arrow > to switch to "Home Connect".

4. Touch "Home Connect settings".
5. Touch "Disconnect from network".

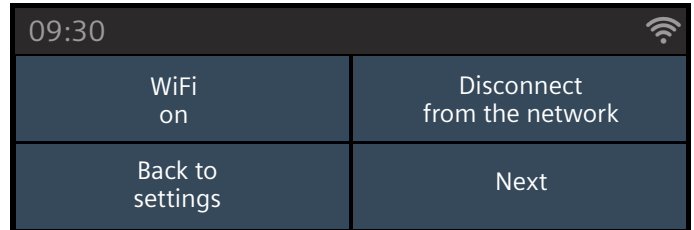

Connecting to the network

1. Press the menu button.
2. Touch "Settings".
3. Touch the arrow > to switch to "Home Connect".
4. Touch "Home Connect settings".
5. Touch "Connect to network".
6. Touch "Connect manually" or "Connect automatically".
7. Follow the instructions in the section entitled "Manual registration in the home network" or "Automatic registration in the home network".

Connect to the app

If the Home Connect app is installed on your mobile device, you can connect it to your oven.

Note: The appliance must be connected to the network.

1. Press the menu button.
2. Touch "Settings".
3. Touch the arrow > to switch to "Home Connect".
4. Touch "Home Connect settings".
5. Touch "Next".
6. Touch "Connect to the app".

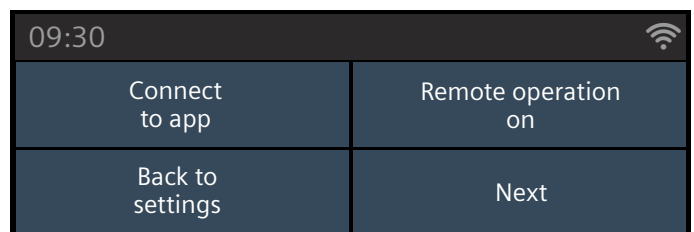

Remote control

You can use the Home Connect app to easily access the functions of your oven.

Notes

- If the appliance is being operated by means of the controls on the appliance itself, this mode of operation always has priority. During this time, it will not be possible to operate the appliance using the Home Connect app.
- The remote control is already activated when the appliance is delivered.
- If the remote control has been deactivated, only the oven's operating statuses will be displayed in the Home Connect app.
- The remote control is automatically activated when the remote start is activated.

1. Press the menu button.
2. Touch "Settings".
3. Touch the arrow > to switch to "Home Connect".
4. Touch "Home Connect settings".

5. Touch "Next".
6. Touch "Remote control" to switch operation via the Home Connect app on or off.

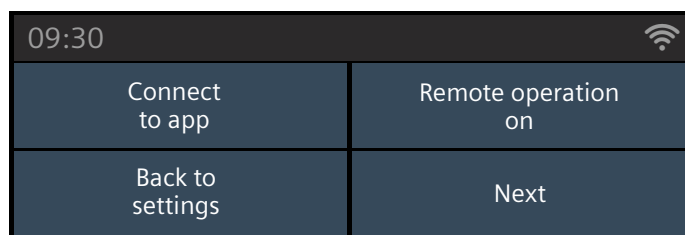

About data protection

When your appliance is connected for the first time to a WLAN network, which is connected to the Internet, your appliance transmits the following categories of data to the Home Connect server (initial registration):

- Unique appliance identification (consisting of appliance codes as well as the MAC address of the installed WiFi communication module).
- Security certificate of the WiFi communication module (to ensure a secure IT connection).
- The current software and hardware version of your domestic appliance.
- Status of any previous resetting to factory settings.

This initial registration prepares the Home Connect functions for use and is only required when you want to use these Home Connect functions for the first time.

Note: Ensure that the Home Connect functions can be used only in conjunction with the Home Connect app. Information on data protection can be accessed in the Home Connect app.

Declaration of Conformity

BSH Hausgeräte GmbH hereby declares that the appliance which features Home Connect is in accordance with the basic requirements and the other relevant provisions of the directive 2014/53/EU.

A detailed RED Declaration of Conformity can be found online at www.siemens-home.bsh-group.com on the product page of your appliance with the additional documents.



Cleaning agent

With good care and cleaning, your appliance will retain its appearance and remain fully functioning for a long time to come. We will explain here how you should correctly care for and clean your appliance.

Suitable cleaning agents

To ensure that the different surfaces are not damaged by using the wrong cleaning agent, observe the information in the table. Depending on the appliance model, not all of the areas listed may be on/in your appliance.

Caution! Risk of surface damage

Do not use:

- Harsh or abrasive cleaning agents,
- Cleaning agents with a high alcohol content,
- Hard scouring pads or cleaning sponges,
- High-pressure cleaners or steam cleaners,
- Special cleaners for cleaning the appliance while it is hot.

Wash new sponge cloths thoroughly before use.

Tip: Highly recommended cleaning and care products can be purchased through the after-sales service. Observe the respective manufacturer's instructions.

Warning – Risk of burns!

The appliance becomes very hot. Never touch the interior surfaces of the cooking compartment or the heating elements. Always allow the appliance to cool down. Keep children at a safe distance.

Area	Cleaning
Appliance exterior	
Stainless steel front	Hot soapy water: Clean with a dish cloth and then dry with a soft cloth. Remove flecks of limescale, grease, starch and albumin (e.g. egg white) immediately. Corrosion can form under such flecks. Special stainless steel cleaning products suitable for hot surfaces are available from our after-sales service or from specialist retailers. Apply a very thin layer of the cleaning product with a soft cloth.
Plastic	Hot soapy water: Clean with a dish cloth and then dry with a soft cloth. Do not use glass cleaner or a glass scraper.
Painted surfaces	Hot soapy water: Clean with a dish cloth and then dry with a soft cloth.
Control panel	Hot soapy water: Clean with a dish cloth and dry with a soft cloth. Do not use glass cleaner or a glass scraper. If descaler comes into contact with the control panel, wipe it off immediately. If you leave it, it may stain the control panel.

Door panels	Hot soapy water: Clean with a dish cloth and then dry with a soft cloth. Do not use a glass scraper or a stainless steel scouring pad.
Door handle	Hot soapy water: Clean with a dish cloth and then dry with a soft cloth. If descaler comes into contact with the door handle, wipe it off immediately. Otherwise, any stains will not be able to be removed.
Appliance interior	
Enamelled surfaces	Hot soapy water or a vinegar solution: Clean with a dish cloth and then dry with a soft cloth. Soften baked-on food residues with a damp cloth and soapy water. Use stainless steel wire wool or oven cleaner to remove stubborn dirt. Leave the cooking compartment open to dry after cleaning. Using the cleaning function gives the best results. → "Cleaning function" on page 22 Note: Food residues can cause white deposits to form. These are harmless and do not affect how the appliance works. Remove using lemon juice if required.
Glass cover for the interior lighting	Hot soapy water: Clean with a dish cloth and then dry with a soft cloth. If the cooking compartment is heavily soiled, use oven cleaner.
Door cover	made from stainless steel: Use stainless steel cleaner. Follow the manufacturers' instructions. Do not use stainless steel care products. made from plastic: Clean using hot soapy water and a dish cloth. Dry with a soft cloth. Do not use glass cleaner or a glass scraper. Remove the door cover for cleaning.
Rails	Hot soapy water: Soak and clean with a dish cloth or brush.
Pull-out system	Hot soapy water: Clean with a dish cloth or a brush. Do not remove the lubricant while the pull-out rails are pulled out – it is best to clean them when they are pushed in. Do not clean in the dishwasher.
Accessories	Hot soapy water: Soak and clean with a dish cloth or brush. If there are heavy deposits of dirt, use a stainless steel scouring pad.
Water tank	Hot soapy water: Clean with a dish cloth and rinse thoroughly to remove residual detergent. Then dry with a soft cloth. Leave the water tank to dry with the lid open. Rub the seal on the lid until dry. Do not clean in the dishwasher.

Notes

- Slight differences in colour on the front of the appliance are caused by the use of different materials, such as glass, plastic and metal.
- Shadows on the door panels, which look like streaks, are caused by reflections made by the interior lighting.
- Enamel is baked on at very high temperatures. This can cause some slight colour variation. This is normal and does not affect operation. The edges of thin trays cannot be completely enamelled. As a result, these edges can be rough. This does not impair the anti-corrosion protection.

Keeping the appliance clean

Always keep the appliance clean and remove dirt immediately so that stubborn deposits of dirt do not build up.

Warning – Risk of fire!

Loose food remnants, fat and meat juices may catch fire. Before using the appliance, remove the worst of the food remnants from the cooking compartment, heating elements and accessories.

Tips

- Clean the cooking compartment after each use. This will ensure that dirt cannot be baked on.
- Always remove flecks of limescale, grease, starch and albumin (e.g. egg white) immediately.
- Use the universal pan for baking very moist cakes.
- Use suitable ovenware for roasting, e.g. a roasting dish.

Rails

With good care and cleaning, your appliance will retain its appearance and remain fully functional for a long time to come. This will tell you how to remove the shelves and clean them.

Detaching and refitting the rails

Warning – Risk of burns!

The rails become very hot. Never touch the hot rails. Always allow the appliance to cool down. Keep children away from the appliance.

Detaching the rails

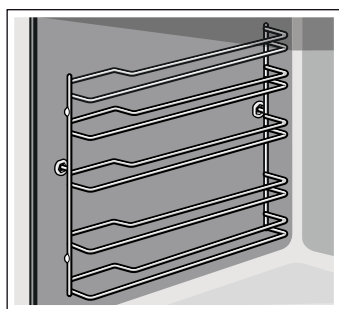

1. Lift the rail slightly at the front **a** and detach it **b** (figure **1**).
2. Then pull the whole rail towards you and take it out (figure **2**).

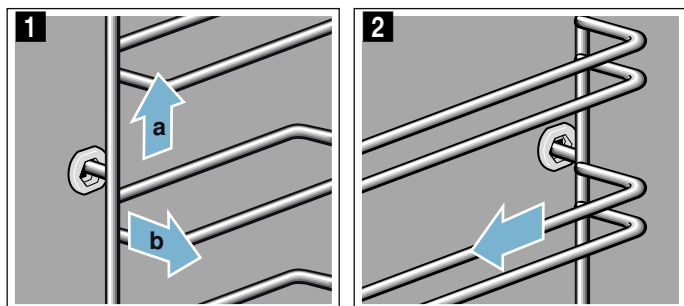

Clean the rails with cleaning agent and a sponge. For stubborn deposits of dirt, use a brush.

Attaching the rails

The rails only fit on the right or the left side. For both rails, ensure that the curved rods are at the front.

1. First, insert the rail in the middle of the rear socket **a**, until the rail rests against the cooking compartment wall, and push it back **b** (figure **1**).
2. Then insert the rail into the front socket **c**, until the rail also rests against the cooking compartment wall here, and press it downwards **d** (figure **2**).

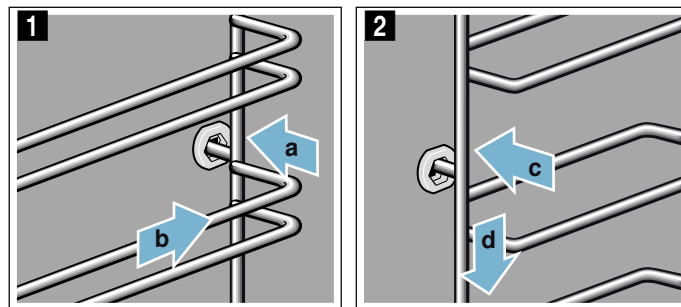

Appliance door

With good care and cleaning, your appliance will retain its appearance and remain fully functional for a long time to come. This will tell you how to remove the appliance door and clean it.

Removing and fitting the appliance door

For cleaning purposes and to remove the door panels, you can detach the appliance door.

The appliance door hinges each have a locking lever. When the locking levers are closed (figure **1**), the appliance door is secured in place. It cannot be detached.

When the locking levers are open in order to detach the appliance door (figure **2**), the hinges are locked. They cannot snap shut.

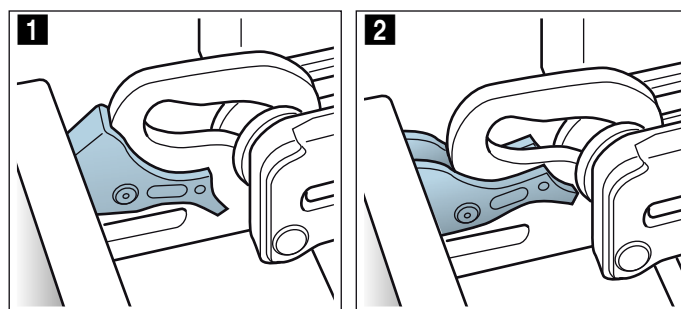

Warning **Risk of injury!**

- If the hinges are not locked, they can snap shut with great force. Ensure that the locking levers are always fully closed or, when detaching the appliance door, fully open.
- The hinges on the appliance door move when opening and closing the door, and you may be trapped. Keep your hands away from the hinges.

Removing the appliance door

1. Open the appliance door fully and push it in the direction of the appliance.
2. Fold up the two locking levers on the left and right (figure 1).
3. Close the appliance door as far as it goes **a**. With both hands, grip the door on the left- and right-hand side and pull it up and out (figure 2).

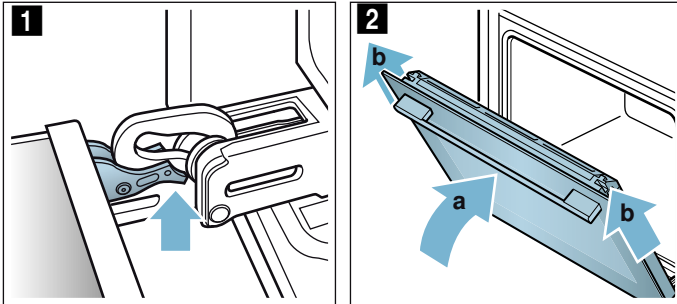

Fitting the appliance door

Reattach the appliance door in the opposite sequence to removal.

1. When attaching the appliance door, ensure that both hinges are inserted straight into the opening (figure 1). Place both hinges at the bottom on the outer panel and use this as a guide. Ensure that the hinges are inserted into the correct opening. You must be able to insert them easily and without resistance. If you can feel any resistance, check that the hinges are inserted into the correct opening.

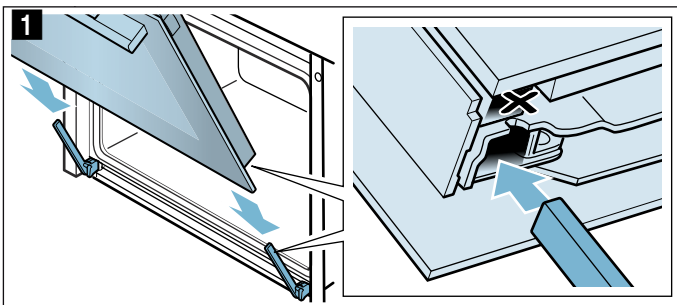

2. Open the appliance door fully. Fold both locking levers closed again (figure 2).

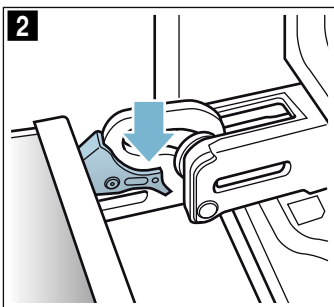

3. Close the cooking compartment door.

Removing the door cover

The stainless steel inlay in the door cover may become discoloured. To carry out thorough cleaning, you can remove the cover.

1. Open the appliance door slightly.
2. Press on the right and left side of the cover (figure 1).
3. Remove the cover (figure 2). Close the appliance door carefully.

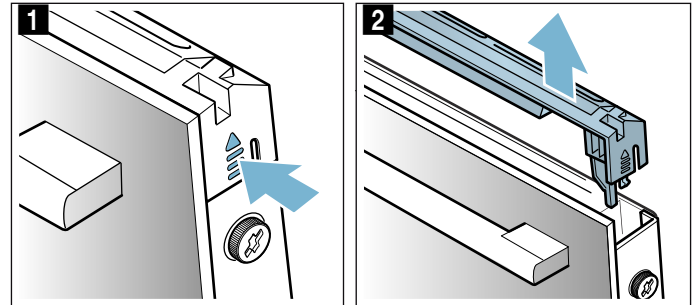

Note: Clean the stainless steel inlay in the cover with stainless steel cleaner. Clean the rest of the door cover with soapy water and a soft cloth.

4. Open the appliance door again slightly. Put the cover back in place and press on it until it clicks audibly into place (figure 3).

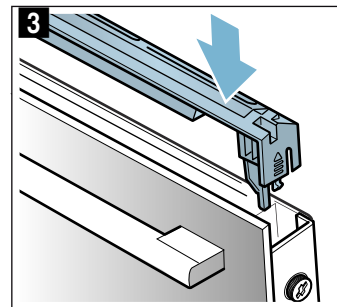

5. Close the appliance door.

Removing and installing the door panels

To facilitate cleaning, you can remove the glass panels from the appliance door.

Removing the door from the appliance

1. Open the appliance door slightly.
2. Press on the right and left side of the cover (figure 1).
3. Remove the cover (figure 2).

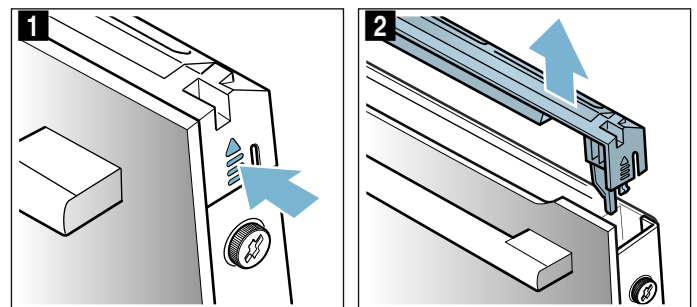

4. Loosen and remove the screws on the left and right of the appliance door (figure 3).
5. Before closing the door again, trap a tea towel which has been folded several times in the door (figure 4). Pull out the front panel upwards and lay it on a flat surface with the door handle facing downwards.

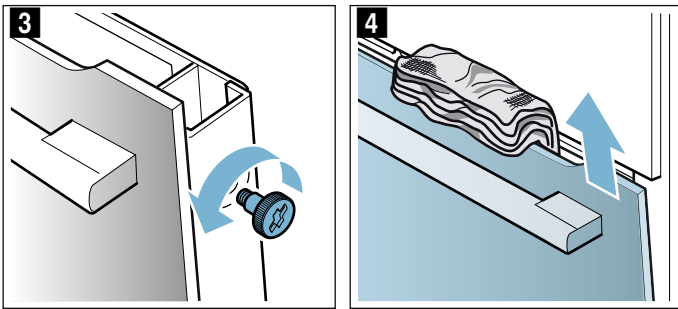

6. Push both retainers on the intermediate panel upwards, but do not remove it (figure 5). Hold the panel with one hand. Remove the panel.

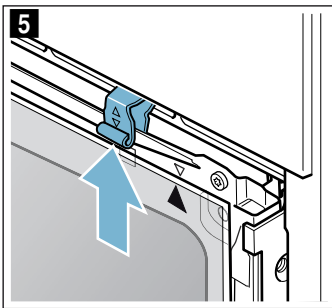

Clean the panels with glass cleaner and a soft cloth.

⚠ Warning
Risk of injury!

- Scratched glass in the appliance door may develop into a crack. Do not use a glass scraper, sharp or abrasive cleaning aids or detergents.
- The hinges on the appliance door move when opening and closing the door, and you may be trapped. Keep your hands away from the hinges.

Fitting the door on the appliance

When fitting the intermediate panel, make sure that the arrow is in the top right of the panel and that it aligns with the arrow on the metal panel.

1. Insert the intermediate panel at the bottom into the retainer and push it in firmly at the top (figure 1).
2. Push both retainers downwards (figure 2).

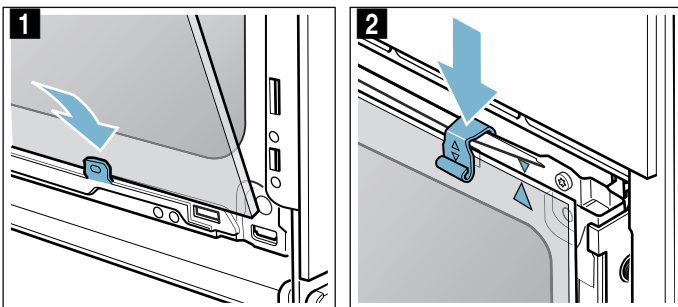

3. Insert the front panel at the bottom into the retainers (figure 3).
4. Close the front panel until both upper hooks are opposite the opening (figure 4).

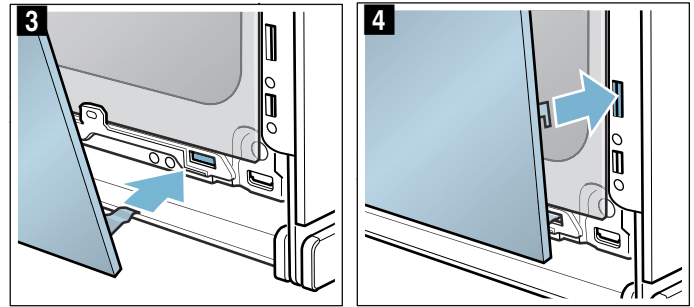

5. Press the front panel at the bottom until it clicks audibly into place (figure 5).
6. Open the appliance door again slightly and remove the tea towel.
7. Screw both screws back in on the left and right.
8. Put the cover back in place and press on it until it clicks audibly into place (figure 6).

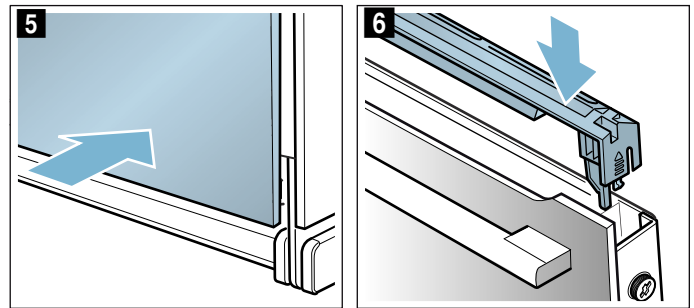

9. Close the appliance door.

Caution!

Do not use the cooking compartment again until the panels have been correctly fitted.

Trouble shooting

If a fault occurs, there is often a simple explanation. Before calling the after-sales service, please refer to the fault table and attempt to correct the fault yourself.

Note: If a dish does not turn out as well as you had hoped, refer to the table section at the end of the instruction manual, where you will find plenty of tips and

information. → "Tested for you in our cooking studio" on page 35







Warning – Risk of electric shock!

Incorrect repairs are dangerous. Repairs may only be carried out and damaged power cables replaced by one of our trained after-sales technicians. If the appliance is defective, unplug the appliance from the mains or switch off the circuit breaker in the fuse box. Contact the after-sales service.

Fault table

If an error message beginning with 'E' is shown, e.g. E0111, switch the appliance off and then on again. If

this message appears again, contact the after-sales service.

Fault	Possible cause	Information/remedial action
The appliance does not work	The fuse is faulty	Check in the fuse box to make sure that the fuse for the appliance is in working order
	Power cut	Check whether other kitchen appliances are working
The appliance door will not open; the  symbol is shown in the display	The appliance door is locked until the cooking compartment has cooled down.	Wait until the  symbol goes out
Although the appliance is switched on, it cannot be operated; the  symbol is shown in the display	The child lock is activated	Press and hold the  button until the  symbol goes out
E8010	The appliance door was opened immediately after the  button was pressed.	Close the appliance door and press the On/Off button
The interior lighting has failed	The LED bulb is defective	Call the after-sales service
Operations with steam or descaling do not start or do not continue	Water tank empty	Refill water tank
	The panel is open	Close the panel
	Descaling locks operations with steam	Carry out descaling
	Faulty sensor	Call the after-sales service
The appliance prompts you to rinse	The power supply was interrupted or the appliance was switched off during the descaling process	Once the appliance is switched on again, rinse it twice
The appliance prompts you to descale without the counter appearing beforehand	The set water hardness range is too low	Carry out descaling Check the set water hardness range and adjust it, if necessary
Buttons flash	Normal occurrence caused by condensation behind the control panel	As soon as the condensation has evaporated, the buttons no longer flash
The cooking compartment does not heat and "Demo mode on" is shown in the display	The appliance is in demo mode	Switch off the fuse in the fuse box and switch it back on again after approx. 10 seconds. Switch on the appliance and select "Demo mode off" in the settings.
The appliance will not start and "Cooking compartment too hot" appears on the display	The cooking compartment is too hot for the selected dish or type of heating	Allow the cooking compartment to cool down and start again
The "Fill water tank" message appears even though the water tank is full	The panel is open	Close the panel
	The water tank is not clicked into place	Click the water tank into place → "Steam" on page 19
	Faulty sensor	Call the after-sales service
	The water tank has fallen off. Due to the impact, components inside the water tank have come loose, and the tank is leaking.	Order a new water tank

Panel does not open 	Power cut	Check whether other kitchen appliances are working
	The circuit breaker is faulty	Check in the fuse box to make sure that the fuse for the appliance is in working order
	Faulty sensor	Call the after-sales service If required, empty the water tank: Open the appliance door, take hold of the lower part of the panel on the left and right with your fingers and pull out the panel
Home Connect does not work correctly.		Go to www.home-connect.com

Maximum operating time exceeded

Your appliance automatically ends the operation if no duration has been set and the setting has not been changed for a long time.

The point at which this occurs depends on the temperature or grill setting that has been set.

A message appears on the display on the appliance to say that the operation is being ended automatically. The operation is then cancelled.

To use the appliance again, first switch it off. To switch the appliance back on again set the required operation.

Tip: Set a cooking time so that the appliance does not switch off when you do not want it to, e.g. with an extremely long preparation time. The appliance heats up until the set cooking time has elapsed.

Cooking compartment bulbs

To light the interior of your cooking compartment, your appliance has one or more long-life LED bulbs.

However, if ever an LED bulb or the bulb's glass cover is defective, call the after-sales service. The lamp cover must not be removed.

Customer service

Our after-sales service is there for you if your appliance needs to be repaired. We will always find an appropriate solution, also in order to avoid after-sales personnel having to make unnecessary visits.

E number and FD number

When calling us, please quote the full product number (E no.) and the production number (FD no.) so that we can provide you with the correct advice. The rating plate bearing these numbers can be found when you open the appliance door.

If your appliance operates with steam, you will find the rating plate on the right-hand side behind the panel.

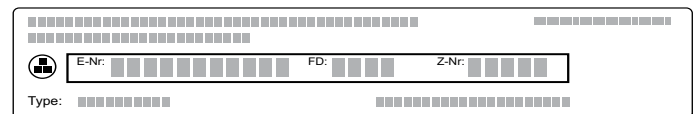

To save time, you can make a note of the numbers for your appliance and the telephone number of the after-sales service in the space below in case you need them.

E no.

FD no.

After-sales service 

Please note that a visit from an after-sales service engineer is not free of charge in the event that the appliance has been misused, even during the warranty period.

Please find the contact data of all countries in the enclosed customer service list.

To book an engineer visit and product advice

GB 0344 892 8999

Calls charged at local or mobile rate.

IE 01450 2655

0.03 € per minute at peak. Off peak 0.0088 € per minute.

Rely on the professionalism of the manufacturer. You can therefore be sure that the repair is carried out by trained service technicians who carry original spare parts for your appliances.

Dishes

You can use the "Dishes" operating mode to prepare a wide variety of food. The appliance chooses the optimal setting for you.

To achieve good results, the cooking compartment must not be too hot for the type of food you have selected. If it is, a message will appear on the display. Allow the cooking compartment to cool down and start again.

Information on the settings

- The cooking result depends on the quality of the food and the size and type of cookware. For an optimal cooking result, use food that is in good condition and chilled meat only. For frozen food, use food straight out of the freezer only.
- For some food, a temperature, heating mode and cooking time is suggested. The temperature and the cooking time can be changed according to your requirements.
- For other dishes, you will be asked to enter the weight. Always enter the total weight unless the appliance asks for something different. The appliance will then apply the time and temperature settings for you.
It is not possible to set weights outside of the intended weight range.
- When roasting dishes for which the appliance will apply the temperature selection for you, temperatures of up to 300 °C can be saved. Therefore, make sure that you use cookware that is sufficiently heat resistant.
- Information is provided, e.g. on cookware, shelf position or the addition of liquid when cooking meat. Some food requires turning or stirring, etc., during cooking. This is shown in the display shortly after operation starts. An audible signal will remind you at the right time.
- Information on the right kind of cookware to use and tips and tricks for the preparation can be found at the end of the instruction manual. → "Tested for you in our cooking studio" on page 35

Steam-assisted cooking

For some food, the steam function is automatically activated. General information on the steam function can be found in the relevant section. → "Steam" on page 19

Warning – Risk of scalding!

When you open the appliance door, hot steam can escape. Steam may not be visible, depending on its temperature. When opening, do not stand too close to the appliance. Open the appliance door carefully. Keep children away.

Selecting a dish

The dishes are arranged in a uniform structure:

- Category
- Food

■ Dish

The following table lists the categories with the corresponding food. One or more dishes are listed beside each food.

Categories	Food
Cake	Cakes in tins
	Cakes on baking trays
	Small baked items
	Biscuits
Bread, bread rolls	Bread
	Bread rolls
Pizza, savoury cakes	Pizza
	Savoury cakes, quiches
Bakes, soufflés	Lasagne, fresh
	Soufflé in individual moulds
	Fruit crumble
	Yorkshire pudding
Frozen products	Pizza
	Bread rolls
	Bakes
	Potato products
	Poultry, fish
Poultry	Chicken
	Duck, goose
	Turkey
Meat	Pork
	Beef
	Lamb
	Meat dishes
Fish	Fish
Vegetables	Baked potatoes, whole
	Vegetables
Reheat, crisp up	Menu
	Baked goods
	Side dishes

Applying settings for dishes

You will be guided through the entire setting process for your chosen food. Always touch the "Next" field.

1. Press the menu button.
The operating modes menu will open.
2. Select "Dishes" mode.
The first category will appear on the display.
3. Use the rotary selector to select the category you require.
4. Touch the "Next" field.
5. Use the rotary selector to select the food.
6. Touch the "Next" field.
7. Use the rotary selector to select the dish.
8. Touch the "Next" field.
9. Turn the rotary selector to set the weight.

Note: Touch the "Tip" field for information on the best shelf position, cookware, etc. to use.

10. Press the Start/Stop button to start.

Once you have implemented all the settings, start the appliance by pressing the Start/Stop button.

For settings that use steam, the appliance only starts after it has heated up.

The setting has ended

A signal sounds. "Finished" appears in the status bar. The oven stops heating. You can cancel the audible signal early using the ⏸ button.

If you are not satisfied with the cooking result, you can increase the cooking time again. Touch the "Extend cooking time" field. A cooking time is suggested. However, you can change this if you want.

If you are satisfied with the cooking result, touch "Finish". "Enjoy your meal" appears in the display.

Cancelling the setting

Press the On/Off button. All settings are deleted. You can implement new settings.

Setting a later end time

For some dishes, it is possible to set a later end time. You can find out how to set a later end time by looking in the time-setting options. → "Time-setting options" on page 16

Once you have set an end time, the display shows the waiting time. The status bar shows the time at which operation is to end. None of the settings can be changed. Please remember that easily spoiled foods must not be allowed to remain in the cooking compartment for too long.

Tested for you in our cooking studio

Here, you can find a selection of dishes and the ideal settings for them. We will show you which type of heating and temperature are best suited to your dish. You will get information on suitable cooking accessories and the height at which they should be placed in the oven. You will also get tips about cookware and preparation methods.

Note: A lot of steam can build up in the cooking compartment when cooking food. Your appliance is very energy-efficient and radiates very little heat to its surroundings during operation. Due to the high difference in temperature between the appliance interior and the external parts of the appliance, condensation may build up on the door, control panel or adjacent kitchen cabinet panels. This is a normal physical phenomenon. Condensation can be reduced by preheating the oven or opening the door carefully. During operation with steam assistance, it is desirable that there is a significant build-up of steam in the cooking compartment. Wipe the cooking compartment clean after cooking, once it has cooled off.

Silicone moulds

We recommend dark-coloured metal baking tins for ideal cooking results.

Nevertheless, if you wish to use silicone moulds, follow the manufacturer's instructions and recipes. Silicone moulds are often smaller than normal baking tins. Quantity and recipe specifications may vary.

Silicone moulds are unsuitable for steam-assisted cooking.

Baking

Here, you can find recommended settings for many dishes.

Also refer to the notes in the section on allowing dough to rise.

Only use original accessories supplied with your appliance. These have been tailored to the cooking compartment and the operating modes of your appliance.

Steam- assisted baking

Certain types of baked item (e.g. yeast-risen pastries) get a more crispy crust and a more glossy surface if baked with the steam assist mode. The baked item does not dry out as much.

Steam-assisted baking is only possible on one level.

Some food turns out better if it is baked in several stages. These dishes are indicated in the table.

Shelf positions

Use the indicated shelf positions.

Baking on one level

When baking on one level, use the following shelf positions:

- Tall baked items: Level 2
- Flat baked items: Level 3

If you are using 4D Hot air as the type of heating, you can choose between levels 1, 2, 3 and 4.

You can also prepare soufflés in a water bath in the universal pan. To do so, slide the universal pan in at level 2.

Baking on two levels

Use 4D hot air. Baked items that are placed into the oven on trays or in baking tins/dishes at the same time will not necessarily be ready at the same time.

- Universal pan: Level 3
Baking tray: Level 1
- Baking tins/dishes on the wire rack
First wire rack: Level 3
Second wire rack: Level 1

By preparing several dishes at the same time, you can make energy savings of up to 45 per cent. Position baking tins/dishes next to one another or offset and vertically stacked in the cooking compartment.

Accessories

Ensure that you always use suitable accessories and that they are placed in the oven the right way around.

Wire rack

Insert the wire rack with the open side facing the appliance door and the curved lip pointing downwards. Always place ovenware, tins and dishes on the wire rack.

Universal pan or baking tray

Slide the universal pan or the baking tray in carefully as far as the limit stop with the bevelled edge facing the appliance door.

When baking moist cakes or pastries with many toppings, use the universal pan so that any excess liquid does not overflow and make the cooking compartment dirty.

Baking tins

Dark- coloured metal baking tins are most suitable.

Tinplate baking tins, ceramic dishes and glass dishes extend baking time and mean that the baked item will not brown evenly. If you wish to bake using these

baking tins/dishes and using top/bottom heating, slide in the tin/dish at level 1.

The baking tins must be resistant to heat and steam for use in steam-assisted baking.

Greaseproof paper

Only use greaseproof paper that is suitable for the selected temperature. Always cut greaseproof paper to size.

Recommended setting values

The table lists the optimal heating type for various baked items. The temperature and baking time depend on the amount and consistency of the dough/mixture. For this reason, the table specifies setting ranges. Try using the lower values to start with. A lower temperature will result in more even browning. You can use a higher setting next time if necessary.

Note: Baking times cannot be reduced by using higher temperatures. Cakes or small baked items would only be cooked on the outside, and would not be fully baked in the middle.



The setting values apply to food that is placed into a cold cooking compartment; by doing this, you can make energy savings of up to 20 per cent. If you preheat the oven, you can reduce the indicated baking times by several minutes.

Preheating is necessary for selected food, and this is indicated in the table. Do not place your food or accessories into the cooking compartment until it has finished preheating.

If you wish to follow one of your own recipes when baking, you should use the setting values listed for similar baked items in the table as reference. Additional information can be found in the baking tips listed after the settings table.





Remove unused accessories from the cooking compartment. This will ensure that you achieve the best possible cooking results and energy savings of up to 20 per cent.

Types of heating used:

-  4D hot air
-  Top/bottom heating
-  Pizza setting





The levels of steam intensity are indicated as numbers in the table:

- 1 = Low
- 2 = Medium
- 3 = High

Dish	Accessories/cookware	Shelf position	Type of heating	Temperature in °C	Steam intensity	Cooking time in mins
One level baking						
Victoria sponge cake	2x Ø20 cm tins	2		160-170*	-	25-30
Victoria sponge cake	2x Ø20 cm tins	2		150-160	1	25-35
Light fruit cake	high Ø20 cm tin	2		140-160	-	70-90
Light fruit cake	high Ø20 cm tin	2		140-150	1	90-100
* Preheat						

Dish	Accessories/cookware	Shelf position	Type of heating	Temperature in °C	Steam intensity	Cooking time in mins
Rich fruit cake	high Ø23 cm tin	2	☉	130-150	-	150-180
Fruit crumble	flat glass dish	3	☉	150-170*	-	35-45
Sponge cake (fat-free), 3 eggs	springform cake tin Ø26 cm	2	☉	160-170*	-	25-35
Sponge cake (fat-free), 3 eggs	springform cake tin Ø26 cm	2	☉	150-160	1	10
					-	20-25
Sponge flan, 6 eggs	springform cake tin Ø28 cm	2	☉	150-170*	-	30-50
Sponge flan, 6 eggs	springform cake tin Ø28 cm	2	☉	150-160	1	10
					-	30-35
Swiss roll	swiss roll tin	3	☉	180-190*	-	10-15
Swiss roll	swiss roll tin	3	☉	180-190*	1	10-15
Fruit pie	plate Ø20 cm or pie tin	2	☉	160-170	-	55-65
Quiche	quiche tin (dark coated)	3	☉	190-210	-	30-40
(White) Bread	loaf tin (1x 900 g or 2x 450 g)	2	☉	180-200*	-	20-30
(White) Bread	loaf tin (1x 900 g or 2x 450 g)	2	☉	190-200	2	30-40
Scones	baking tray	3	☉	180-200*	-	10-14
Biscuits	baking tray	3	☉	140-160*	-	10-25
Small cakes	12-cup tin	3	☉	140-160*	-	20-30
Puff pastry slices	baking tray	3	☉	170-190*	-	20-35
Puff pastry slices	baking tray	3	☉	200-220*	1	15-25
Jam tarts	12-cup tin	3	☉	170-190*	-	15-30
Meringue	baking tray	3	☉	80-90*	-	120-150
Pavlova	baking tray	3	☉	90-100*	-	120-180
Soufflé	1.2l soufflé dish	2	☉	160-170*	-	35-45
Soufflé	1.2l soufflé dish	2	☉	160-180	2	35-45
Soufflé	individual moulds	2	☐	170-190	-	65-75
Choux pastry	baking tray	3	☉	190-210*	-	30-40
Choux pastry	baking tray	3	☉	200-220*	1	25-35
Meat pie	rectangular pie tin	2	☉	180-190	-	40-50
Meat pie	rectangular pie tin	2	☉	170-180	2	40-50
Yorkshire pudding	12-cup tin	3	☉	200-220*	-	15-25
Jacket potatoes	baking tray	3	☉	150-170	-	75-90
Jacket potatoes	universal pan	3	☉	180-190	2	40-50
Pizza, homemade	baking tray	3	☉	200-220	-	25-35
Pizza, homemade, thin base	pizza tray	2	☐	250-270	-	20-25
Pizza, homemade, thin base	pizza tray	2	☉	210-220	-	25-30
Multishelf baking						
Victoria sponge cake, 2 levels	4x Ø20 cm tins	3+1	☉	160-170*	-	25-35
Scones, 2 levels	2 baking trays	3+1	☉	170-190*	-	12-16
Biscuits, 2 levels	2 baking trays	3+1	☉	140-160*	-	10-25
Biscuits, 3 levels	3 baking trays	5+3+1	☉	140-160*	-	15-30
Small cakes, 2 levels	2x 12-cup tins	3+1	☉	140-160*	-	22-32
Puff pastry slices, 2 levels	2 baking trays	3+1	☉	170-190*	-	25-45
Puff pastry slices, 3 levels	3 baking trays	5+3+1	☉	170-190*	-	25-45

* Preheat

Dish	Accessories/cookware	Shelf position	Type of heating	Temperature in °C	Steam intensity	Cooking time in mins
Jam tarts, 2 levels	2x 12-cup tins	3+1		170-190*	-	20-35
Meringues, 2 levels	2 baking trays	3+1		80-90*	-	120-150
Jacket potatoes, 2 levels	universal pan + baking tray	3+1		150-170*	-	75-90
(White) Bread, 2 levels	4x loaf tins	3+1		170-190*	-	30-40
Pizza, homemade, 2 levels	universal pan + baking tray	3+1		180-200	-	35-45

* Preheat

Tips on baking

You want to find out whether the cake is completely cooked in the middle.	Push a cocktail stick into the highest point on the cake. If the cocktail stick comes out clean with no dough residue, the cake is ready.
The cake collapses.	Next time, use less liquid. Alternatively, set the temperature to be 10 °C lower and extend the baking time. Adhere to the specified ingredients and preparation instructions in the recipe.
The cake has risen in the middle but is lower around the edge.	Only grease the base of the springform cake tin. After baking, loosen the cake carefully with a knife.
The fruit juice overflows.	Next time, use the universal pan.
Small baked items stick to one another during baking.	There should be a gap of approx. 2 cm around each item. This gives enough space for the baked items to expand well and brown on all sides.
The cake is too dry.	Set the temperature 10 °C higher and shorten the baking time.
The cake is generally too light in colour.	If the shelf position and the cookware are correct, then you should increase the temperature if necessary or extend the baking time.
The cake is too light on top, and too dark underneath.	Bake the cake one level higher in the oven the next time.
The cake is too dark on top, and too light underneath.	Bake the cake one level lower in the oven the next time. Select a lower temperature and extend the baking time.
Cakes baked in a tray or tin are too brown at the back.	Place the baking tray in the middle of the accessories, not directly against the back wall.
The whole cake is too dark.	Select a lower temperature next time and extend the baking time if necessary.
The cake is unevenly browned.	Select a slightly lower temperature. Protruding greaseproof paper can affect the air circulation. Always cut greaseproof paper to size. Ensure that the baking tin does not stand directly in front of the openings in the cooking compartment back wall. When baking small items, you should use similar sizes and thicknesses wherever possible.
You were baking on several levels. The items on the top baking tray are darker than those on the lower baking tray.	Always select 4D hot air when baking on several levels. Baked items that are placed into the oven on trays or in baking tins/dishes at the same time will not necessarily be ready at the same time.
The cake looks good, but is not cooked properly in the middle.	Use a lower temperature and bake slightly longer; if necessary, add slightly less liquid. For cakes with a moist topping, bake the base first. Sprinkle it with almonds or breadcrumbs and then place the topping on top.
The cake cannot be turned out of the dish when it is turned upside down.	Allow the cake to cool down for 5 to 10 minutes after baking. If it still sticks, carefully loosen the cake around the edges again using a knife. Turn the cake tin upside down again and cover it several times with a cold, wet cloth. Next time, grease the baking tin/dish and sprinkle with breadcrumbs.

Roasting and braising

Here, you can find information on roasting and braising poultry and meat. You can find the ideal settings for many dishes in the settings tables.

Poultry

For duck or goose, pierce the skin on the underside of the wings. This allows the fat to run out.

If using duck breast, score the skin. Do not turn duck breasts.

When you turn poultry, ensure that the breast side or the skin side is underneath at first.

Poultry will turn out particularly crispy and brown if you baste it towards the end of the roasting time with butter, salted water or orange juice.

Meat

Baste lean meat with fat as required or cover it with strips of bacon.

Score the rind crosswise. If you turn the joint when cooking, ensure that the rind is underneath at first.

When the joint is ready, turn off the oven and allow it to rest for another 10 minutes in the cooking compartment. This allows the meat juices to be better distributed. Wrap the joint in aluminium foil if necessary. The recommended resting time is not included in the cooking time indicated.

Roasting on the wire rack

On the wire rack, poultry and meat will become very crispy on all sides. Roasting on the wire rack is well suited for larger poultry or for multiple pieces at the same time.

Depending on the size and type of the meat, add up to ½ litres of water to the universal pan. Any dripping fat and meat juices will be caught. You can prepare a sauce using these meat juices. In addition, less smoke is generated, and the cooking compartment stays cleaner.

Slide the universal pan into the oven at the indicated shelf position with the wire rack attached. Ensure that the wire rack is correctly positioned on the universal pan. → "Accessories" on page 12

Roasting and braising in cookware

It is more convenient to roast and braise meat in cookware. You can take the joint out of the cooking compartment more easily in the cookware, and prepare the sauce in the cookware itself.

Only use cookware which is suitable for use in an oven. Check whether the cookware fits in the cooking compartment.

Glass cookware is most suitable. Place hot glass cookware onto a dry mat after cooking. If the surface is damp or cold, the glass may crack.

Add in a little liquid for roasting if the meat is lean. A covering of approx. ½ cm depth should be applied to the base of any glass cookware.

The amount of liquid is dependent on the type of meat, the cookware material and also on whether or not a lid is used. If preparing meat in an enamelled or dark metal

roasting dish, it will need a little more liquid than if cooked in glass cookware.

The steam evaporates in the cookware when roasting. Carefully pour in more liquid if required.

Shiny roasting dishes made from stainless steel or aluminium reflect heat like a mirror and are therefore not particularly suitable. The meat cooks more slowly and will not brown so much. Use a higher temperature and/or a longer cooking time.

Observe the manufacturer's instructions for your roasting cookware.

Roasting in uncovered cookware

It is best to use a deep roasting tin/dish for roasting poultry and meat. Place the tin/dish onto the wire rack. If you do not have any suitable cookware, use the universal pan.

Braising in covered cookware

When preparing food with covered cookware, the cooking compartment remains considerably cleaner. Ensure that the lid fits well and closes properly. Place the cookware onto the wire rack.

The distance between the meat and the lid must be at least 3 cm. The meat may rise.

Very hot steam may escape when opening the lid after cooking. Lift the lid at the rear, so that the hot steam can escape away from you.

If necessary, braise the meat first by searing it. Add water, wine, vinegar or a similar liquid to the braising liquid. A covering at least 2 cm deep should be applied to the base of the cookware.

The steam evaporates in the cookware when roasting. Carefully pour in more liquid if required.

Steam-assisted roasting and braising

Certain dishes become crispier if cooked using steam, and do not dry out as much.

Use uncovered cookware. Cookware must be heat- and steam-resistant.

The joints do not have to be turned.

Use steam-assisted cooking if it is indicated in the settings table. Some dishes turn out best if they are cooked in several stages. These are indicated in the table.

Recommended setting values

In the table, you can find the ideal heating type for poultry and meat. Temperature and cooking time depend on the quantity, composition and temperature of the food. Different settings ranges are indicated for this reason. Try using the lower values at first. You can increase the temperature next time if necessary.

The setting values are based on the assumption that unstuffed, chilled, ready-to-roast poultry and meat are placed into a cold cooking compartment. By doing so, you can make energy savings of up to 20 per cent. If you preheat the oven, the indicated cooking times will be reduced by several minutes.

In the table, you can find specifications for poultry and meat with default values for the weight. If you wish to prepare heavier poultry or meat, use the lower temperature in every case. If roasting several joints, use

the weight of the heaviest piece as a basis for determining the cooking time. The individual pieces should be approximately equal in size.

A general rule: the larger the poultry or piece of meat is, the lower the cooking temperature and the longer the cooking time.

Turn the poultry and meat after approx. 1/2 to 2/3 of the indicated time.

Remove unused accessories from the cooking compartment. This will achieve the best possible cooking results and energy savings of up to 20 per cent.

Cooking time calculation (e. g. 20+35):
Please calculate the cooking time with 20 minutes per

500 g meat + 35 minutes additional time. For 1,5 kg the calculated cooking time would be 95 minutes.



















Cooking time range (e. g. 10-15):
The food is done within the stated minutes.

Type of heating used:

-  4D hot air

The levels of steam intensity are indicated as numbers in the table:

- 1 = Low
- 2 = Medium
- 3 = High

Dish	Accessories/cookware	Shelf position	Type of heating	Temperature in °C	Steam intensity	Time in min.
Beef						
Slow roasting joint	wire rack	2		140-150	-	35+40
Slow roasting joint, 1.5 kg	wire rack	2		130-140	1	70-80
					-	40-50
Top side / Top rump	wire rack	2		160-170	-	30+25
Top side / Top rump, 1.5 kg	wire rack	2		170-180	1	100-120
Lamb						
Leg (bone-in)	wire rack	2		160-170	-	25+25
Leg (bone-in), 1.5 kg	wire rack	2		180-190	1	80-90
Shoulder (bone-in)	wire rack	2		160-170	-	25+20
Shoulder (boned and rolled)	wire rack	2		170-180	-	25+25
Rack of lamb**	wire rack	2		180-190*	-	15+25
Rack of lamb (each 700 g)	wire rack	2		200	-	20
				170-180	1	25-30
Pork						
Roasting joint	wire rack	2		180-190	-	30+35
Roasting joint, 1.5 kg	wire rack	2		120	3	30
				190-200	-	30
				160-170	1	80-100
Loin joint	wire rack	2		180-190	-	35+35
Loin joint, 1 kg	wire rack	2		180-190	-	25-30
				170-180	1	70-80
Belly	wire rack	2		170-180	-	30+25
Gammon joint	wire rack	2		160-170	-	30+30
Gammon joint, 1.5 kg	wire rack	2		170-180	2	100-120
Poultry						
Chicken, whole	wire rack	2		170-180	-	25+15

* Preheat

** Without fat layer (best and neck), do not turn

*** Skin side down

**** Bone side down

***** Turn after app. 1 hour

Dish	Accessories/cookware	Shelf position	Type of heating	Temperature in °C	Steam intensity	Time in min.
Chicken, whole, 1.5 kg	wire rack	2	☉	180-190	2	65-75
Chicken, portion (each 200-250 g)***	wire rack	2	☉	190-200	-	35-45
Chicken, portion (each 200-250 g)***	wire rack	2	☉	200-210	2	35-45
Duck	wire rack	2	☉	180-190	-	25+20
Duck, 2-3 kg	wire rack	2	☉	160-170	2	70-90
				170-180	-	30-40
Turkey, crown****	wire rack	2	☉	150-160	-	20+15
Turkey, crown, 3 kg	wire rack	2	☉	140-150	2	100-140
Turkey, thighs	wire rack	2	☉	170-180	-	25+30
Turkey, whole, 4-8 kg*****	wire rack	2	☉	150-160	-	12+12
Turkey, whole, 7 kg	wire rack	1	☉	140-150	2	120-150
				170-180	-	30-40
Meat dishes						
Meat loaf	cookware, uncovered	2	☉	170-180	-	20+35
Meat loaf, 1 kg	cookware, uncovered	2	☉	190-200	1	70-80
Casserole						
Diced meat (beef, pork, lamb), 500 g meat	cookware, covered	2	☉	140*	-	100-120
Diced chicken (boned), 500 g meat	cookware, covered	2	☉	140*	-	90-100
Braising steak	cookware, covered	2	☉	140	-	65+60
Complete meal						
With beef	wire rack + wire rack	4+1	☉	160, then 200 (Yorkshire Pudding)	-	calculation for meat (see table above) + 15-25 for Yorkshire Pudding
With chicken	wire rack + wire rack	4+1	☉	180	-	calculation for chicken (see table above)
With chicken, 1.5 kg	wire rack + wire rack	4+2	☉	180	low (steam 0 when Yorkshire Pudding is inserted)	65-75
* Preheat						
** Without fat layer (best and neck), do not turn						
*** Skin side down						
**** Bone side down						
***** Turn after app. 1 hour						

Tips on roasting and braising

The cooking compartment becomes very dirty.	Prepare your food in an enclosed roasting dish with higher temperature or use the grill tray. You will achieve the best roasting results if you use the grill tray. The grill tray can be bought later as a special accessory.
The roast is too dark and the crackling is burned in places, and/or the roast is too dry.	Check the shelf position and temperature. Select a lower temperature the next time and reduce the roasting time if necessary.
The crackling is too thin.	Increase the temperature or switch on the grill briefly at the end of the roasting time.

The roast looks good but the juices are burnt.	Next time, use a smaller roasting dish and add more liquid if necessary.
The roast looks good but the juices are too clear and watery.	Next time, use a larger roasting dish and add less liquid if necessary.
The meat gets burned during braising.	The roasting dish and lid must fit together well and close properly. Reduce the temperature and add more liquid when braising if necessary.

Grilling

Here, you can find information on grilling poultry, meat and fish, as well as toast. You can find the ideal settings for certain dishes in the settings tables.

Grilling with circulated air

Circulated air grilling is very well suited to the preparation of whole poultry, fish, and also meat, e.g. roast pork with crackling.

Poultry

For duck or goose, pierce the skin on the underside of the wings. This allows the fat to run out.

If using duck breast, score the skin. Do not turn duck breasts.

When you turn poultry, ensure that the breast side or the skin side is underneath at first.

Poultry will turn out particularly crispy and brown if you baste it towards the end of the roasting time with butter, salted water or orange juice.

Meat

Baste lean meat with fat as required or cover it with strips of bacon.

Score the rind crosswise. If you turn the joint when cooking, ensure that the rind is underneath at first.

When the joint is ready, turn off the oven and allow it to rest for another 10 minutes in the cooking compartment. This allows the meat juices to be better distributed. Wrap the joint in aluminium foil if necessary. The recommended resting time is not included in the cooking time indicated.

Fish

Fish cooked whole does not have to be turned. Place the whole fish into the cooking compartment in swimming position with the dorsal fin facing upwards. Placing half a potato or a small oven-proof container in the stomach cavity of the fish will provide stability.

You can tell when the fish is cooked because the dorsal fin can be removed easily.

Roasting on the wire rack

On the wire rack, poultry and meat will become very crispy on all sides. Roasting on the wire rack is well suited for larger poultry or for multiple pieces at the same time.

Depending on the size and type of the meat, add up to ½ litres of water to the universal pan. Any dripping fat and meat juices will be caught. You can prepare a sauce using these meat juices. In addition, less smoke is generated, and the cooking compartment stays cleaner.

Slide the universal pan into the oven at the indicated shelf position with the wire rack attached. Ensure that

the wire rack is correctly positioned on the universal pan. → "Accessories" on page 12

Roasting in cookware

It is more convenient to roast and braise meat in cookware. You can take the joint out of the cooking compartment more easily in the cookware, and prepare the sauce in the cookware itself.

Only use cookware which is suitable for use in an oven. Check whether the cookware fits in the cooking compartment.

Glass cookware is most suitable. Place hot glass cookware onto a dry mat after cooking. If the surface is damp or cold, the glass may crack.

Add in a little liquid if the meat is lean. A covering of approx. ½ cm depth should be applied to the base of any glass cookware.

The quantity of liquid is dependent on the type of meat, the cookware material and also on whether or not a lid is used. If preparing poultry, meat or fish in an enamelled or dark metal roasting dish, it will need a little more liquid than if cooked in glass cookware.

The steam evaporates in the cookware when roasting. Carefully pour in more liquid if required.

Shiny roasting dishes made from stainless steel or aluminium reflect heat like a mirror and are therefore not particularly suitable. The meat cooks more slowly and will not brown so much. Use a higher temperature and/or a longer cooking time.

Observe the manufacturer's instructions for your roasting cookware.

Uncovered cookware

Use a deep roasting tin/dish for roasting meat. Place the tin/dish onto the wire rack. If you do not have any suitable cookware, use the universal pan.

Covered cookware

When cooking with covered cookware, the cooking compartment remains considerably cleaner. Ensure that the lid fits well and closes properly. Place the cookware onto the wire rack.

The distance between the meat and the lid must be at least 3 cm. The meat may rise.

Very hot steam may escape when opening the lid after cooking. Lift the lid at the rear, so that the hot steam can escape away from you.

If necessary, braise the meat first by searing it. Add water, wine, vinegar or a similar liquid to the braising liquid. A covering approx. 1-2 cm deep should be applied to the base of the cookware.

The steam evaporates in the cookware when roasting. Carefully pour in more liquid if required.

Meat can also become crispy in a covered roasting dish. To do so, use a roasting dish with a glass lid and set a higher temperature.

Steam- assisted roasting

Certain foodstuffs will become crispier during steam-assisted cooking. Their surface becomes glossier and they dry out less.

Use uncovered cookware. Cookware must be heat- and steam-resistant.

Use steam-assisted cooking if it is indicated in the settings table. Some dishes turn out best if they are cooked in several stages. These are indicated in the table.

Grilling flat pieces

Flat pieces of poultry, meat and fish, such as steaks, drumsticks and burgers, can be prepared well using the "Grill" heating type. Excellent results are also achieved when grilling toast.

Grilling

Keep the appliance door closed when using the grill. Never grill with the appliance door open.

Place the food to be grilled on the wire rack. In addition, slide the universal pan in at least one shelf position lower, with the slanted edge facing the appliance door. Any dripping fat will be caught.

When grilling, try wherever possible to use pieces of food which are of a similar thickness and weight. This will allow them to brown evenly and remain succulent and juicy. Place the food to be grilled directly onto the wire rack.

Use tongs to turn the pieces of food you are grilling. If you pierce the meat with a fork, the juices will run out and it will become dry.

Do not add salt until after the meat has been grilled. Salt draws water from the meat.

Notes

- The grill element switches itself continuously on and off; this is normal. The grill setting determines how frequently this occurs.
- Smoke may be produced when grilling.

Recommended setting values

In the table, you can find the ideal heating type for your poultry, meat and fish, in addition to toast. Temperature and cooking time depend on the quantity, composition and temperature of the food. Settings ranges are indicated for this reason. Try using the lower values at first. You can use a higher setting next time if necessary.

The setting values are based on the assumption that unstuffed, chilled, ready-to-roast poultry, meat and fish are placed into a cold cooking compartment.

In the table, you can find specifications for poultry, meat and fish with default values for the weight. If you wish to prepare heavier poultry, meat or fish, use the lower temperature in every case. If roasting several joints, use the weight of the heaviest piece as a basis for determining the cooking time. The individual pieces should be approximately equal in size.

A general rule: the larger the poultry, meat or fish is, the lower the cooking temperature and the longer the cooking time.



Turn the poultry, meat and fish after approx. 1/2 to 2/3 of the indicated time.

Remove unused accessories from the cooking compartment. This will achieve the best possible cooking results and energy savings of up to 20 per cent.

Cooking time calculation (e. g. 20+35):
Please calculate the cooking time with 20 minutes per 500 g meat + 35 minutes additional time. For 1,5 kg the calculated cooking time would be 95 minutes.



Cooking time range (e. g. 10-15):
The food is done within the stated minutes.

Types of heating used:

-  Circulated air grilling
-  Grill, large area

The levels of steam intensity are indicated as numbers in the table:

- 1 = Low
- 2 = Medium
- 3 = High

Dish	Accessories	Shelf position	Type of heating	Temperature in C / Grill setting	Steam intensity	Time in min.
Beef						
Steaks, height 2-3 cm**	wire rack	3		3	-	1st side 10-12 2nd side 3-5
Burger, height 1-2 cm	wire rack	3		3*	-	1st side 6-8 2nd side 4-6
Top side / Top rump	wire rack	2		150-160	-	30+30

- * Preheat
- ** Do not preheat
- *** Preheat 3 minutes
- **** Preheat 3 minutes, turn over several times
- ***** Preheat 5 minutes
- ***** Skin side down

Dish	Accessories	Shelf position	Type of heating	Temperature in C / Grill setting	Steam intensity	Time in min.
Lamb						
Steaks, height 2-3 cm	wire rack	3		3*	-	1st side 8-10 2nd side 4-6
Chops, height 2-3 cm	wire rack	3		3	-	1st side 6-8 2nd side 6-8
Leg (bone-in)	wire rack	2		170-180	-	25+30
Leg (bone-in), 1.5 kg	wire rack	2		170-180	1	80-90
Shoulder (bone-in)	wire rack	2		170-190	-	25+15
Shoulder (boned and rolled)	wire rack	2		170-180	-	20+15
Rack of lamb	wire rack	2		190-200	-	15+25
Pork						
Steaks, height 2 cm	wire rack	5		2	-	1st side 10-12 2nd side 5-7
Chops, height 2-3 cm	wire rack	3		3*	-	1st side 10-12 2nd side 9-10
Burger, height 1-2 cm	wire rack	3		3***	-	1st side 6-8 2nd side 4-6
Bacon rashers	wire rack	3		3*****	-	1st side 4-5 2nd side 3-4
Sausages, thickness 2-4 cm	wire rack	3		3****	-	10-15
Roasting joint	wire rack	2		180-200	-	30+40
Loin joint	wire rack	2		180-200	-	35+35
Belly	wire rack	2		200-220	-	30+25
Belly, 1 kg	wire rack	2		170-180 190-200	1 -	50-60 25-35
Gammon joint	wire rack	2		180-200	-	30+25
Poultry						
Chicken drumstick, 150 g each	wire rack	3		210-230	-	20-30
Chicken drumstick, 150 g each	wire rack	3		210-220	2	30-40
Chicken breast, boned, 150 g each	wire rack	3		3***	-	1st side 10-15 2nd side 10-15
Chicken breast, boned, 150 g each	wire rack	3		200-210	2	20-30
Chicken, whole	wire rack	2		200-220	-	20+15
Chicken, whole, 1.5 kg	wire rack	2		180-190	2	65-75
Chicken, portion, bone-in 200-250 g each*****	wire rack	3		200-220	-	30-45
Chicken, portion, bone-in 200-250 g each*****	wire rack	3		200-210	2	35-45
Duck, 2-3 kg	wire rack	2		190-200	-	20+20
* Preheat						
** Do not preheat						
*** Preheat 3 minutes						
**** Preheat 3 minutes, turn over several times						
***** Preheat 5 minutes						
***** Skin side down						

Dish	Accessories	Shelf position	Type of heating	Temperature in C / Grill setting	Steam intensity	Time in min.
Duck, 2-3 kg	wire rack	2		150-160	2	100-120
Turkey, thighs	wire rack	2		180-190	-	25+30
Turkey, whole, 4-8 kg	wire rack	2		140-160	-	12+12
Turkey, whole, 7 kg	wire rack	1		140-150	2	120-150
				170-180	-	30-40
Fish						
Trout, whole, 300 g each	wire rack	2		170-190	-	20-30
Fillets, each 150 g	wire rack	4		1***	-	1st side 5-10
						2nd side 5-10
Toast						
Grilling white bread**	wire rack	5		3	-	4-6
* Preheat						
** Do not preheat						
*** Preheat 3 minutes						
**** Preheat 3 minutes, turn over several times						
***** Preheat 5 minutes						
***** Skin side down						

Convenience products

Here, you can find the ideal settings for preparing chilled and frozen food.

Only use original accessories supplied with your appliance. These have been tailored to the cooking compartment and the operating modes of your appliance.

Tips

- The cooking result greatly depends on the quality of the food. Pre-browning and unevenness may already be present on the packaged product.
- Do not use frozen products that are heavily frosted. Remove any ice on the food.
- Distribute foods which are in pieces, such as bread rolls and potato products, so that they are spread flat and evenly on the accessories. Leave a little space between the individual pieces.
- Observe the instructions on the packaging.

Steam- assisted baking

Certain types of baked item (e.g. yeast-risen pastries) get a more crispy crust and a more glossy surface if baked with the steam assist mode. The baked item does not dry out as much.

Steam-assisted baking is only possible on one level.

Shelf positions

Use the indicated shelf positions.

Baking on one level

When baking on one level, use the following shelf positions:

- Tall baked items: Level 2
- Flat baked items: Level 3

If you are using 4D Hot air as the type of heating, you can choose between levels 1, 2, 3 and 4.

Baking on two levels

Use 4D hot air. Baked items that are placed into the oven on trays or in baking tins/dishes at the same time will not necessarily be ready at the same time.

- Universal pan: Level 3
- Baking tray: Level 1

Accessories

Ensure that you always use suitable accessories and that they are placed in the oven the right way around.

Wire rack

Insert the wire rack with the open side facing the appliance door and the curved lip pointing downwards. Always place ovenware, tins and dishes on the wire rack.

Universal pan or baking tray

Slide the universal pan or the baking tray in carefully as far as the limit stop with the bevelled edge facing the appliance door.

Greaseproof paper

Only use greaseproof paper that is suitable for the selected temperature. Always cut greaseproof paper to size.

Recommended setting values

In the table, you can find the ideal heating type for various dishes. Temperature and cooking time depend on the quantity and composition of the product. Setting ranges are indicated for this reason. Try using the lower values at first. A lower temperature results in more even browning. You can use a higher setting next time if necessary.

Note: Cooking times cannot be reduced by using higher temperatures. The dish would only be cooked on the outside, but would not be fully cooked in the middle.





The setting values apply to dishes placed into a cold cooking compartment. By doing so, you can make energy savings of up to 20 per cent. If you preheat the oven, the indicated cooking times will be reduced by several minutes.

Preheating is necessary for selected dishes, and this is indicated in the table.

Remove unused accessories from the cooking compartment. This will achieve the best possible





















cooking results and energy savings of up to 20 per cent.

Types of heating used:

-  4D hot air
-  Top/bottom heating
-  Pizza setting
-  coolStart function



The levels of steam intensity are indicated as numbers in the table:

- 1 = Low
- 2 = Medium
- 3 = High

Dish	Accessories/cookware	Shelf position	Type of heating	Temperature in °C	Steam intensity	Cooking time in mins.
Pizza, chilled						
Pizza, chilled	wire rack	3		190-210	-	10-15
Pizza, frozen						
Pizza, thin base*	wire rack	3		-	-	-
Pizza, thin base, 2 levels	universal pan + wire rack	3+1		190-210	-	20-25
Pizza, thick base	wire rack	3		-	-	-
Pizza, thick base, 2 levels	universal pan + wire rack	3+1		190-210	-	20-30
Pizza baguette*	wire rack	3		-	-	-
Potatoe products, frozen						
Oven chips*	universal pan	3		-	-	-
Oven chips, 2 levels	universal pan + baking tray	3+1		190-210	-	30-40
Croquettes*	universal pan	3		-	-	-
Hash browns*	universal pan	3		-	-	-
Potatoe wedges*	universal pan	3		-	-	-
Baked goods, frozen, prebaked						
Rolls, baguettes*	universal pan	3		-	-	-
Rolls, baguettes	universal pan	3		180-200	1	15-25
Fried food, frozen						
Fish fingers**	universal pan	3		200-220	-	20-30
Chicken nuggets	universal pan	3		-	-	-
Food, chilled						
Lasagna, 500 g	ovenproof dish on wire rack	2		-	-	-
Lasagna, 500 g	ovenproof dish on wire rack	2		180-190	2	30-40
Lasagna, 1,5 kg	ovenproof dish on wire rack	2		180-200	-	30-40
Lasagna, 1,5 kg	ovenproof dish on wire rack	2		160-170	2	35-45
Food, frozen						
Lasagna, 500 g	ovenproof dish on wire rack	2		-	-	-
Lasagna, 500 g	ovenproof dish on wire rack	2		180-190	2	40-50

* Observe information on the packaging

** Turn during cooking

Dish	Accessories/cookware	Shelf position	Type of heating	Temperature in °C	Steam intensity	Cooking time in mins.
Lasagna, 1,5 kg	ovenproof dish on wire rack	2		180-200	-	50-70
Lasagna, 1,5 kg	ovenproof dish on wire rack	2		160-170	2	45-55

* Observe information on the packaging
** Turn during cooking

Yogurt

You can make your own yogurt using your appliance.

Preparing yogurt

Remove accessories and shelves from the cooking compartment. The cooking compartment must be empty.

1. Heat 1 litre of milk (3.5 % fat) to 90 °C on the hob and then cool down to 40 °C.
It is sufficient to heat UHT milk to 40 °C.

2. Stir in 150 g (chilled) yogurt.
3. Pour into cups or small jars and cover with cling film.
4. Place the cups or jars onto the cooking compartment floor and use the settings indicated in the table.
5. After preparation, leave the yogurt to cool in the refrigerator.

Type of heating used:

-  Proving dough

Dish	Cookware	Shelf position	Type of heating	Temperature in °C	Cooking time in hours
Yoghurt	individual moulds	cooking compartment floor		35-40	5-6

Eco types of heating

Hot air eco and Top/bottom heating eco are intelligent heating types for the gentle preparation of meat, fish and pastries. The appliance optimally controls the supply of energy to the cooking compartment. The food is prepared in phases using residual heat. This means that it remains more succulent and browns less. Energy can be saved, depending on the preparation and food.

Place the food into the empty cooking compartment before it has heated up. Always keep the appliance door closed when cooking.

Remove unused accessories from the cooking compartment. This will allow you to achieve optimum cooking results and save energy.

Only use original accessories supplied with your appliance. These have been tailored to the cooking compartment and the operating modes of your appliance.

Accessories

Ensure that you always use suitable accessories and that they are placed in the oven the right way around.

Wire rack

Insert the wire rack with the open side facing the appliance door and the curved lip pointing downwards. Always place ovenware, tins and dishes on the wire rack.

Universal pan or baking tray

Slide the universal pan or the baking tray in carefully as far as the limit stop with the bevelled edge facing the appliance door.

Baking tins and cookware

Dark- coloured metal baking tins are most suitable. These allow you to make energy savings of up to 35 per cent.

Cookware made from stainless steel or aluminium reflects heat like a mirror. Non-reflective cookware made from enamel, heat-resistant glass or coated, die-cast aluminium is more suitable.

Tinplate baking tins, ceramic dishes or glass dishes prolong baking time, and the cake will not brown so evenly.

Greaseproof paper

Only use greaseproof paper that is suitable for the selected temperature. Always cut greaseproof paper to size.

Recommended setting values





















Here, you can find specifications for various dishes. The temperature and baking time are dependent on the quantity and composition of the dough. Different settings ranges are indicated for this reason. Try using the lower values at first. A lower temperature results in more even browning. If necessary, use a higher setting the next time.

Note: Baking times can not be reduced by using higher temperatures. Cakes or baked items would only be cooked on the outside, but would not be cooked completely in the middle.

Types of heating used:

■  Hotair Eco

■  Top/bottom heating Eco

Dish	Accessories/cookware	Shelf position	Type of heating	Temperature in °C	Cooking time in mins.
Baking					
Victoria Sponge Cake	2x Ø20 cm tins	2		170-180	25-35
Light Fruit Cake	high Ø20 cm tin	2		150-170	70-90
Rich Fruit Cake	high Ø23 cm tin	2		140-160	120-180
Fruit crumble	flat glass dish	3		160-180	40-70
Sponge Cake (fatless), 3 eggs	springform cake tin Ø26 cm	2		160-170	25-40
Swiss Roll	swiss roll tin	3		180-190	15-25
Fruit Pie	plate Ø20 cm or pie tin	2		170-190	60-75
Quiche	quiche tin (dark coated)	3		190-210	35-45
(White) Bread	loaf tin (1x 900 g or 2x 450 g)	2		190-200	40-50
Scones	baking tray	3		190-210	15-20
Jam tarts	12-cup-tin	3		180-200	20-30
Soufflé	1,2L-soufflé dish	2		160-170	40-50
Meat Pie	rectangular pie tin	2		190-200	40-55
Jacket Potatoes	baking tray	3		150-170	60-90
Meat					
Beef, slow roast joint	wire rack	2		140-150	35+40
Casserole					
Diced meat (beef, pork, lamb), 500 g meat	cookware, covered	2		140	100-120
Braising steak	cookware, covered	2		140	65+60
Fish					
Fish, braised, whole 300 g, e. g. trout	cookware, covered	2		190-210	25-35
Fish, braised, whole 1,5kg, e. g. salmon	cookware, covered	2		190-210	45-55
Fish fillet, plain, braised, 100 g	cookware, covered	2		190-210	15-25

Acrylamide in foodstuffs

Acrylamide is mainly produced in grain and potato products prepared at high temperatures, such as potato

crisps, chips, sliced bread, bread rolls, bread or fine baked goods (biscuits, gingerbread, spiced biscuit).

Tips for keeping acrylamide to a minimum	
General	<ul style="list-style-type: none"> ■ Keep cooking times as short as possible. ■ Cook food until it is golden brown, but not too dark. ■ Large, thick pieces of food contain less acrylamide.
Baking	With top/bottom heating at max. 200 °C. With hot air at max. 180 °C.
Biscuits	With top/bottom heating at max. 190 °C. With hot air at max. 170 °C. Egg or egg yolk reduces the production of acrylamide.
Oven chips	Spread out a single layer evenly on the baking tray. Cook at least 400 g at once on a baking tray so that the chips do not dry out.

Slow cook

Slow cooking is a technique for cooking food over a long period at low temperatures. For this reason, it is also called "low-temperature cooking".

Slow cooking is ideal for all prime cuts (e.g. tender portions of beef, veal, pork, lamb or poultry) which are to be cooked "à point". The meat will remain succulent and tender.

The benefit of this cooking method is that it allows lots of scope for menu planning because slow-cooked meat is easy to keep warm. You do not have to turn the meat when cooking. Keep the appliance door closed in order to maintain an even cooking climate.

Only use fresh, clean and hygienic meat without bones. Carefully remove sinews and fat from around the edge. Fat develops a strong, distinct flavour during slow cooking. You can also use seasoned or marinated meat. Do not use defrosted meat.

Meat can be carved immediately following slow cooking. No standing time is required. Due to the special cooking method, the meat looks pink, but is not raw or undercooked.

Note: Delayed-start operation with an end time is not possible for the slow cooking heating type.

Cookware

Use shallow cookware, e.g. a glass/porcelain serving dish. Place the cookware into the cooking compartment to preheat it.

Always place the uncovered cookware onto the wire rack at level 2.

You can find additional information in the tips on slow cooking attached to the settings table.

Your appliance features the heating type "Slow cook". Only start operation when the cooking compartment has fully cooled down. Allow the cooking compartment to warm up for approx. 15 minutes with the cookware inside.













Sear the meat on the hotplate at a very high heat and for a sufficiently long time on all sides, even on the ends. Place into the preheated cookware right away. Place the cookware containing the meat into the cooking compartment once again and cook slowly.

Recommended setting values

The slow cooking temperature and cooking time are dependent on the size, thickness and quality of the meat. Different settings ranges are indicated for this reason.

Type of heating used:

-  Slow cooking

Dish	Cookware	Shelf position	Heating function	Searing time in mins	Temperature in °C	Cooking time in mins
Poultry						
Duck breast, medium rare, 300 g each	Cookware, uncovered	2		6-8	90*	45-60
Chicken breast fillet, 200 g each, well done	Cookware, uncovered	2		4	120*	45-60
Turkey breast, boned, 1 kg, well done	Cookware, uncovered	2		6-8	120*	110-130
Pork						
Pork tenderloin steak, 5-6 cm thick, 1.5 kg	Cookware, uncovered	2		6-8	80*	130-180
Fillet of pork, whole	Cookware, uncovered	2		4-6	80*	45-70
Beef						
Joint of beef (rump), 6-7 cm thick, 1.5 kg	Cookware, uncovered	2		6-8	100*	150-180
Fillet of beef, 1 kg	Cookware, uncovered	2		4-6	80*	90-120
Sirloin, 5-6 cm thick	Cookware, uncovered	2		6-8	80*	120-180
Beef medallions/rump steak, 4 cm thick	Cookware, uncovered	2		4	80*	30-60
Veal						
Joint of veal, 4-5 cm thick, 1.5 kg	Cookware, uncovered	2		6-8	80*	80-140
Joint of veal, 7-10 cm thick, 1.5 kg	Cookware, uncovered	2		6-8	80*	140-200
Fillet of veal, whole, 800 g	Cookware, uncovered	2		4-6	80*	70-120
Veal medallions, 4 cm thick	Cookware, uncovered	2		4	80*	30-50

* Preheat

Dish	Cookware	Shelf position	Heating function	Searing time in mins	Temperature in °C	Cooking time in mins
Lamb						
Saddle of lamb, boneless, 200 g each	Cookware, uncovered	2		4	80*	30-45
Leg of lamb, boned, medium, 1 kg, tied	Cookware, uncovered	2		6-8	95*	120-180
* Preheat						

Tips for slow cooking

Slow-cooking duck breast.	Place the cold duck breast into a pan and fry the skin side first. After slow cooking, grill for 3 to 5 minutes until crispy.
The slow-cooked meat is not as hot as conventionally roasted meat.	So that the roasted meat does not cool so quickly, warm the plates and serve the sauces very hot.

Drying

With 4D hot air, you can dry foods with outstanding results. With this type of preserving, flavourings are concentrated by the dehydration.

Only use unblemished fruit, vegetables and herbs and wash them thoroughly. Line the wire rack with greaseproof paper or parchment paper. Drain the excess water from the fruit and dry it.

If necessary, cut it into equal chunks or thin slices. Place unpeeled fruit onto the dish with the sliced surfaces facing upwards. Ensure that neither fruit nor mushrooms overlap on the wire rack.

Grate vegetables and then blanch them. Allow the blanched vegetables to drain off and distribute them evenly on the wire rack.

Dry herbs on the stem. Position the herbs evenly and slightly heaped on the wire rack.

Use the following shelf positions for drying:

- 1 wire rack: Level 3

- 2 wire racks: Level 3+1

Turn very juicy fruit and vegetables several times. After drying, remove the dried products from the paper immediately.

Recommended setting values

In the table, you can find settings for drying various foodstuffs. The temperature and cooking time are dependent on the type, moisture, ripeness and thickness of the food to be dried. The longer you leave the food to be dried, the better it will be preserved. The thinner the slices are, the quicker the drying process will be and the more aromatic the dried food will remain. Setting ranges are indicated for this reason.

If you wish to dry additional foodstuffs, you should use similar foodstuffs in the table as a reference.

Type of heating used:

- 4D hot air

Fruit, vegetables and herbs	Accessories	Type of heating	Temperature in °C	Cooking time in hours
Pomes (apple rings, 3 mm thick, 200 g per wire rack)	1-2 wire racks		80	5-9
Stone fruit (plums)	1-2 wire racks		80	8-10
Root vegetables (carrots), grated, blanched	1-2 wire racks		80	5-8
Sliced mushrooms	1-2 wire racks		60	6-9
Herbs, washed	1-2 wire racks		60	2-6

Preserving

You can preserve fruit and vegetables using your appliance.

Warning – Risk of injury!

If the food is preserved incorrectly, the preserving jars may burst. Follow the instructions for preserving.

Jars

Use only clean and undamaged preserving jars. Only use heat-resistant, clean and undamaged rubber rings. Check clips and clamps in advance.

For each preserving process, only use preserving jars that are the same size and contain the same food. In the cooking compartment, you can preserve the contents of a maximum of six ½, 1 or 1½-litre preserving jars at the same time. Do not use jars that are larger or taller than this. The lids could rupture.

Preserving jars must not touch one another in the cooking compartment during the preserving process.

Preparing fruit and vegetables

Only use fruit and vegetables that are in good condition. Wash them thoroughly.

Peel, core and chop fruit and vegetables appropriate to their type and fill the preserving jars with them up to approx. 2 cm below the rim.

Fruit

Fill the preserving jars with the fruit along with a hot, skimmed sugar solution (approx. 400 ml for a 1-litre jar). For one litre of water:

- Approx. 250 g sugar for sweet fruit
- Approx. 500 g sugar for sour fruit

Vegetables

Fill the jars with the vegetables along with hot, boiled water.

Wipe the rims of the jars, as they must be clean. Place a damp rubber ring and a lid on each jar. Seal the jars with clamps. Place the jars into the universal pan so that they do not touch each other. Pour 500 ml hot water (approx. 80 °C) into the universal pan. Use the settings indicated in the table.

Ending the preserving process

Fruit

After a short while, small bubbles will form at short intervals. Switch off the appliance once all preserving jars are bubbling. Remove the jars from the cooking compartment after the indicated cooling time.

Vegetables

After a short while, small bubbles will form at short intervals. As soon as all preserving jars are bubbling, reduce the temperature to 120 °C and allow the jars to continue to bubble in the closed cooking compartment as indicated in the table. After this time has elapsed, switch off the appliance and make use of the residual heat for several minutes as indicated in the table.





After preserving, remove the jars from the cooking compartment and place them onto a clean cloth. Do not place these hot jars onto a cold or damp surface, as they may crack. Cover the preserving jars to protect them from draughts. Only remove the clamps once the jars are cold.

Recommended setting values

The indicated times in the settings table are average values for preserving fruit and vegetables. They may be influenced by room temperature, the number of jars, quantity, heat and quality of the jar contents. The specifications are based on 1-litre round jars. Before you switch off the appliance or change the cooking mode, check whether the contents of the jars are bubbling as they should. The bubbling process starts after approx. 30-60 minutes.

Type of heating used:

-  4D hot air

Preserving	Cookware	Shelf position	Type of heating	Temperature in °C	Cooking time in mins.
Vegetables, e.g. carrots	1-litre preserving jars	1		160-170	Before it starts bubbling:30-40
				120	When it starts to bubble: 30-40
				-	Residual heat: 30
Vegetables, e.g. cucumbers	1-litre preserving jars	1		160-170	Before it starts bubbling: 30-40
				-	Residual heat: 30
				-	Residual heat: 30
Stone fruit, e.g. cherries, damsons	1-litre preserving jars	1		160-170	Before it starts bubbling:30-40
				-	Residual heat:35
				-	Residual heat: 25
Pomes, e.g. apples, strawberries	1-litre preserving jars	1		160-170	Before it starts bubbling:30-40
				-	Residual heat: 25
				-	Residual heat: 25

Proving dough

Dough will prove considerably more quickly using the "Dough proving" heating type than at room temperature and does not dry out. Only start operation when the cooking compartment has fully cooled down.

Always allow yeast dough to prove twice. Observe the specifications in the settings tables for the 1st and 2nd proving processes (dough fermentation and final fermentation).

Dough fermentation

Position the dough bowl on the wire rack for the dough fermentation. Use the settings indicated in the table.

Do not open the appliance door during the proving process, as moisture will escape. Do not cover the dough.

Final fermentation

Place your baked item into the oven at the shelf position indicated in the table.

Wipe moisture from the cooking compartment before baking.

Recommended setting values

The temperature and proving time are dependent on the type and quantity of the ingredients. The values in the table are therefore only meant to be average values.

Type of heating used:

-  Proving dough

Dish	Accessories/cookware	Shelf position	Type of heating	Step	Temperature in °C	Cooking time in mins.
Yeast dough, sweet						
E.g. small baked items	Bowl	2		Dough fermentation	35-40	30-45
	Universal pan	2		Final fermentation	35-40	10-20
Rich dough, e.g. panettone	Bowl	2		Dough fermentation	40-45	40-90
	Tin on wire rack	2		Final fermentation	40-45	30-60
Yeast dough, savoury						
E.g. pizza	Bowl	2		Dough fermentation	35-40	20-30
	Universal pan	2		Final fermentation	35-40	10-15
Bread dough						
White bread	Bowl	2		Dough fermentation	35-40	30-40
	Universal pan	2		Final fermentation	35-40	15-25
Multigrain bread	Bowl	2		Dough fermentation	35-40	25-40
	Universal pan	2		Final fermentation	35-40	10-20
Bread rolls	Bowl	2		Dough fermentation	35-40	30-40
	Universal pan	2		Final fermentation	35-40	15-25

Defrosting

Use heating type 4D hot air to defrost fruit, vegetables and baked items. Poultry, meat and fish should ideally be defrosted in the refrigerator.

Use the following shelf positions when defrosting:

- 1 wire rack: Level 2
- 2 wire racks: Level 3+1

Recommended setting values

The times in the table are average values. They are dependent on the quality, freezing temperature (-18 °C) and composition of the food. Time ranges are indicated. Set the shortest time first and then extend the time if necessary.

Dish	Accessories	Shelf position	Type of heating	Temperature in °C	Cooking time in mins.
Bread, bread rolls					
Bread & bread rolls general	Baking tray	2		50	40-70
Cake					
Cake, moist	Baking tray	2		50	70-90
Cake, dry	Baking tray	2		60	60-75

Reheating

Using heating type "Reheating", food is reheated gently using steam. It tastes and looks as though it has been freshly prepared. Even baked items from the day before can be re-crisped.

Use containers which are as flat, wide and heat-resistant as possible. Cold containers prolong the reheating process.

Where possible, only reheat dishes of the same size and type at the same time. If this is not possible, the time required for the component with the longest reheating time should be used as a basis.

Do not cover food while it is being reheated.

Place the food in the cookware onto the wire rack or place it directly onto the wire rack at level 2.

Do not open the appliance door during operation, as a lot of steam will escape.

Dish	Accessories/cookware	Shelf position	Type of heating	Temperature in °C	Cooking time in mins.
Vegetables, chilled					
1 kg	Cookware, uncovered	2		120-130	15-25
250 g	Cookware, uncovered	2		120-130	5-15
Dishes, chilled					
Plated meal, 1 portion	Cookware, uncovered	2		120-130	15-25
Soup, stew, 400 ml	Cookware, uncovered	2		120-130	10-25
* Preheat					

Tip: Items which were frozen flat or portioned defrost faster than those frozen in a block.

Remove frozen food from the packaging and place it in suitable cookware onto the wire rack.

Stir the food or turn it once or twice in between. Large pieces of food should be turned several times. Occasionally split the food or remove items which have already defrosted from the cooking compartment.

Leave the defrosted food to rest for another 10 to 30 minutes in the appliance whilst it is switched off, so that the temperature balances out.

Type of heating used:

- 4D hot air

Recommended setting values







In the table, you can find the ideal settings for various dishes. The times specified are only average values. They are dependent on the cookware used, the quality, temperature and consistency of the food. Time ranges are indicated. Set the shortest time first and then extend the time if necessary.

The values in the table apply to dishes placed into a cold cooking compartment. Preheating is necessary for selected dishes, and this is indicated in the table.

Remove unused accessories from the cooking compartment. This will allow you to achieve ideal cooking results and save energy.

Type of heating used:

- Reheating

Dish	Accessories/cookware	Shelf position	Type of heating	Temperature in °C	Cooking time in mins.
Side dishes, e.g. pasta, dumplings, potatoes, rice	Cookware, uncovered	2		120-130	8-25
Bakes, e.g. lasagne, potato gratin	Cookware, uncovered	2		120-140	10-25
Pizza, cooked	Wire rack	2		170-180*	5-15
Baked goods					
Bread rolls, baguette, baked	Wire rack	2		150-160*	10-20
Pastries (vol-au-vents)	Wire rack	2		180*	4-10
Baked goods, frozen					
Pizza, cooked	Wire rack	2		170-180*	5-15
Bread rolls, baguette, baked	Wire rack	2		160-170*	10-20
* Preheat					

Keeping warm

You can keep cooked dishes warm using the "Keeping warm" heating type. You can use the various moisture levels to prevent the cooked dishes from drying out.

Do not cover the food.

Do not keep cooked dishes warm for longer than two hours. Be aware that some dishes may continue cooking whilst being kept warm. Do not cover the food.

The various steam levels are suitable for keeping the following foods warm:

- Level 1: Roasted joints and pan-fried foods
- Level 2: Bakes and side dishes
- Level 3: Stews and soups

Test dishes

These tables have been produced for test institutes to facilitate appliance testing.

As per EN 60350-1.

Baking

Baked items that are placed into the oven on trays or in baking tins/dishes at the same time will not necessarily be ready at the same time.

Shelf positions for baking on two levels:

- Universal pan: Level 3
Baking tray: Level 1
- Baking tins/dishes on the wire rack
First wire rack: Level 3
Second wire rack: Level 1

Shelf positions for baking on three levels:

- Baking tray: Level 5
- Universal pan: Level 3
- Baking tray: Level 1

Apple pie

Apple pie on one level: place dark-coloured springform cake tins diagonally next to each other.

Apple pie on two levels: position dark-coloured springform cake tins above each other so that they are offset.

Cakes in tinplate springform cake tins: bake on one level with top/bottom heating. Place the springform cake tin onto the universal pan instead of onto the wire rack.



Fatless sponge cake

Fatless sponge cake on two levels: vertically stack springform cake tins in an offset manner on the wire racks.

Notes







- The setting values apply to dishes placed into a cold cooking compartment.
- Please note the information in the tables about preheating. The setting values are valid without rapid heating-up.
- For baking, use the lower of the indicated temperatures first.

Types of heating used:

-  4D hot air
-  Top/bottom heating
-  Pizza setting

The levels of steam intensity are indicated as numbers in the table:

- 1 = Low
- 2 = Medium
- 3 = High



Dish	Accessory	Shelf position	Type of heating	Temperature in °C	Steam intensity	Cooking time in mins.
Baking						
Shortbread	Baking tray	3		140-150*	-	25-40
Shortbread	Baking tray	3		140-150*	-	25-40
Shortbread, 2 levels	Universal pan + baking tray	3+1		140-150*	-	30-40
Shortbread, 3 levels	Baking trays + universal pan	5+3+1		130-140*	-	35-55
Small cakes	Baking tray	3		160*	-	20-30
Small cakes	Baking tray	3		150*	-	25-35
Small cakes, 2 levels	Universal pan + baking tray	3+1		150*	-	25-35
Small cakes, 3 levels	Baking trays + universal pan	5+3+1		140*	-	35-45
Fatless sponge cake	Springform cake tin, diameter 26 cm	2		160-170**	-	25-35
Fatless sponge cake	Springform cake tin, diameter 26 cm	2		160-170**	-	30-40
Fatless sponge cake	Springform cake tin, diameter 26 cm	2		150-160	1	10
					-	20-25
Fatless sponge cake, 2 levels	Springform cake tin, diameter 26 cm	3+1		150-170**	-	30-50
Apple pie	2 x black plate tins, diameter 20 cm	2		170-180	-	60-80
Apple pie	2 x black plate tins, diameter 20 cm	2		180-200	-	60-80
Apple pie, 2 levels	2 x black plate tins, diameter 20 cm	3+1		170-190	-	70-90
* Preheat for 5 mins, do not use quick heat function						
** Preheat, do not use quick heat function						

Grilling

Also slide in the universal pan. The liquid will be caught and the cooking compartment stays cleaner.

Type of heating used:

-  Grill, large area

Dish	Accessories	Shelf position	Type of heating	Grill setting	Cooking time in mins.
Grilling					
Toasting bread*	Wire rack	5		3	4-6
Beefburger, 12 pieces**	Wire rack	4		3	25-30
* Do not preheat					
** Turn after 2/3 of the total time					

BSH Hausgeräte GmbH
Carl-Wery-Str. 34, 81739 München
GERMANY

siemens-home.bsh-group.com

Manufactured by BSH Hausgeräte GmbH under Trademark License of Siemens AG



9001240958
961011