

SIEMENS



Flex induction cooktop with integrated ventilation system

EX8..LX3.E

siemens-home.bsh-group.com/welcome

en Instruction manual

Register
your
product
online

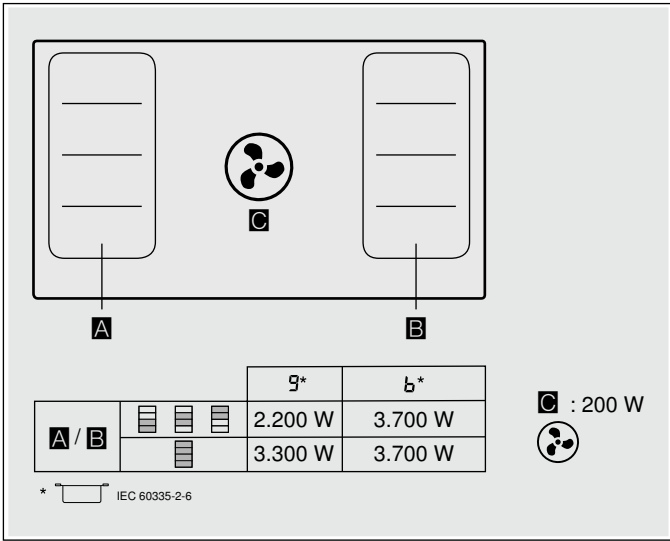



Table of contents

	Intended use	4		ShortBoost function	22
	Important safety information	5	Recommendations for use	22	
	Causes of damage	7	Activating	22	
	Environmental protection	8	Deactivating	22	
	Saving energy	8		Keep warm function	22
	Environmentally-friendly disposal	8	Activating	22	
	Induction cooking	8	Deactivating	22	
	Advantages of induction cooking	8		Transferring settings	23
	Cookware	8	Activation	23	
	Getting to know your appliance	10		Cooking assist functions	24
	Your new appliance	10	Cooking assistant function types	24	
	Special accessories	10	Suitable cookware	24	
	The control panel	11	Sensors and special accessories	25	
	Residual heat indicator	11	Functions and heat settings	25	
	Cooking sensor function (optional)	12	Recommended dishes	28	
	Operating modes	12	Preparing and maintaining the wireless temperature sensor	33	
	Before using for the first time	12	Declaration of Conformity	34	
	Initial use	12		Childproof lock	35
	Operating the appliance	13	Activating and deactivating the childproof lock	35	
	Switching the hob on and off	13	Childproof lock	35	
	Applying hotplate settings	13		Wipe protection	35
	Switching the ventilation system on and off	14		Automatic safety cut-out	35
	Intensive setting	14		Basic settings	36
	Automatic start	14	To access the basic settings:	37	
	Automatic mode with sensor control	15		Energy consumption indicator	38
	Run-on function	15		Cookware check	39
	Chef's recommendations	15		Cleaning	39
	Flex Zone	18	Cleaning agents	39	
	Advice on using cookware	18	Components to clean	40	
	As a single hotplate	18	Hob surround (only on appliances with hob surrounds)	40	
	As two independent hotplates	18	Hob	41	
	Move function	19	Ventilation system	41	
	Activation	19	Cleaning the overflow container	43	
	Deactivating	19	Wireless temperature sensor	43	
	Time-setting options	20		Frequently Asked Questions (FAQ)	44
	Programming the cooking time	20		Trouble shooting	46
	The kitchen timer	20			
	Stopwatch function	21			
	PowerBoost function	21			
	Activating	21			
	Deactivating	21			

	Customer service	48
	E number and FD number	48
	Test dishes	49

Additional information on products, accessories, replacement parts and services can be found at www.siemens-home.bsh-group.com and in the online shop www.siemens-home.bsh-group.com/eshops

Intended use

Read these instructions carefully. Please keep the instruction and installation manual, as well as the appliance certificate, in a safe place for later use or for subsequent owners.

Check the appliance after removing it from the packaging. If it has suffered any damage in transport, do not connect the appliance, contact the Technical Assistance Service and provide written notification of the damage caused, otherwise you will lose your right to any type of compensation.

This appliance must be installed according to the installation instructions included.

This appliance is intended for private domestic use and the household environment only. The appliance must only be used for the preparation of food and beverages. The cooking process must be supervised. A short cooking process must be supervised without interruption. Only use the appliance in enclosed spaces.

This appliance is intended for use up to a maximum height of 2000 metres above sea level.

Do not use covers. These can cause accidents, for example due to overheating, catching fire or materials shattering.

Only use safety devices or child protection grilles approved by ourselves. Unsuitable safety devices or child protection grilles may result in accidents.

This appliance is not intended for operation with an external clock timer or a remote control.

This appliance may be used by children over the age of 8 years old and by persons with reduced physical, sensory or mental capabilities or by persons with a lack of experience or knowledge if they are supervised or are instructed by a person responsible for their safety how to use the appliance safely and have understood the associated hazards.

Children must not play with, on, or around the appliance. Children must not clean the appliance or carry out general maintenance unless they are at least 15 years old and are being supervised.

Keep children below the age of 8 years old at a safe distance from the appliance and power cable.

When using the cooking functions, set the hotplate on which you have placed the saucepan with the temperature sensor.

We advise that you exercise caution using or standing near an induction hob while it is in operation, if you wear a pacemaker or a similar medical device. Consult your doctor or the device manufacturer concerning its conformity or any possible incompatibilities,

Important safety information

The appliance can only be used safely if it is correctly installed according to the safety instructions. The installer is responsible for ensuring that the appliance works perfectly at its installation location.

Only a licensed professional may connect appliances without plugs. Damage caused by incorrect connection is not covered under warranty.

Dangerous or explosive materials and vapours must not be extracted.

Ensure that no small parts or liquids get into the appliance.

Check the appliance for damage after unpacking it. Do not connect the appliance if it has been damaged in transport.

This appliance is not intended for operation with an external clock timer or a remote control.

Warning – Danger of suffocation!

Packaging material is dangerous to children. Never allow children to play with packaging material.

Warning – Danger of death!

Risk of poisoning from flue gases that are drawn back in.

Always ensure adequate fresh air in the room if the appliance is being operated in exhaust air mode at the same time as room air-dependent heat-producing appliance is being operated.

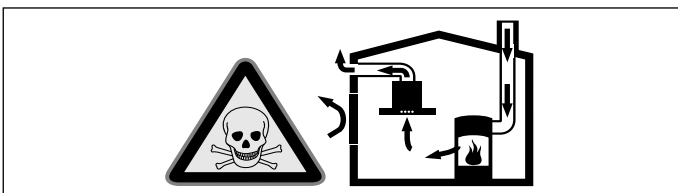

Room air-dependent heat-producing appliances (e.g. gas, oil, wood or coal-operated heaters, continuous flow heaters or water heaters) obtain combustion air from the room in which they are installed and discharge the exhaust gases into the open air through an exhaust gas system (e.g. a chimney).

In combination with an activated vapour extractor hood, room air is extracted from the kitchen and neighbouring rooms - a partial vacuum is produced if not enough fresh air is supplied. Toxic gases from the chimney or the extraction shaft are sucked back into the living space.

- Adequate incoming air must therefore always be ensured.
- An incoming/exhaust air wall box alone will not ensure compliance with the limit.

Safe operation is possible only when the partial vacuum in the place where the heat-producing appliance is installed does not exceed 4 Pa (0.04 mbar). This can be achieved when the air needed for combustion is able to enter through openings that cannot be sealed, for example in doors, windows, incoming/exhaust air wall boxes or by other technical means.

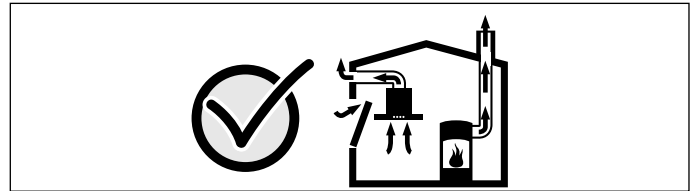

In any case, consult your responsible Master Chimney Sweep. He is able to assess the house's entire ventilation setup and will suggest the suitable ventilation measures to you.

Unrestricted operation is possible if the vapour extractor hood is operated exclusively in the circulating-air mode.

Warning – Risk of fire!

- Hot oil and fat can ignite very quickly. Never leave hot fat or oil unattended. Never use water to put out burning oil or fat. Switch off the hotplate. Extinguish flames carefully using a lid, fire blanket or something similar.
- The hotplates become very hot. Never place combustible items on the hob. Never place objects on the hob.
- The appliance gets hot. Do not keep combustible objects or aerosol cans in drawers directly underneath the hob.
- The hob switches off automatically and can no longer be operated. It may switch on unintentionally at a later point. Switch off the circuit breaker in the fuse box. Contact the after-sales service.

- Grease deposits in the grease filter may catch fire.
Clean the grease filter at least once a month.
Never operate the appliance without the grease filter.
- Fatty deposits in the filters may catch fire. Clean the appliance as described. Comply with the cleaning intervals. Never operate the appliance without the grease filter.
- When the ventilation system is switched on, fatty deposits in the grease filter may catch fire. Never work with naked flames close to the appliance (e.g. flambéing). Do not install the appliance near a solid fuel heating appliance (e.g. wood- or coal-burning) unless a sealed, non-removable cover is fitted. There must be no flying sparks.

⚠ Warning – Risk of burns!

- The hotplates and surrounding area (particularly the hob surround, if fitted) become very hot. Never touch the hot surfaces. Keep children at a safe distance.
- The hotplate heats up but the display does not work. Switch off the circuit breaker in the fuse box. Contact the after-sales service.
- Metal objects on the hob quickly become very hot. Never place metal objects (such as knives, forks, spoons and lids) on the hob.
- The filter cover will get very hot very quickly if left on the hob. Never place the filter cover on the hob. Do not place pots, pans or other hot objects on the filter cover.
- After each use, always turn off the hob at the main switch. Do not wait until the hob turns off automatically after the pan is removed.
- The accessible parts become very hot when in operation. Never touch hot parts. Keep children at a safe distance.
- The appliance will become hot during operation. If hot liquids penetrate the appliance, leave the appliance to cool for at least two hours before removing the filter cover, the metal grease filter, the container, the overflow reservoir or the appliance housing.

⚠ Warning – Risk of electric shock!

- Incorrect repairs are dangerous. Repairs may only be carried out and damaged power cables replaced by one of our trained after-sales technicians. If the appliance is defective, unplug the appliance from the mains or switch off the circuit breaker in the fuse box. Contact the after-sales service.
- Do not use any high-pressure cleaners or steam cleaners, which can result in an electric shock.
- A defective appliance may cause electric shock. Never switch on a defective appliance. Unplug the appliance from the mains or switch off the circuit breaker in the fuse box. Contact the after-sales service.
- Cracks or fractures in the glass ceramic may cause electric shocks. Switch off the circuit breaker in the fuse box. Contact the after-sales service.

⚠ Warning – Electromagnetic hazards!

- This appliance complies with safety and electromagnetic compatibility standards. However, people with pacemakers or insulin pumps must refrain from using this appliance. It is impossible to ensure that all of these devices available on the market comply with current electromagnetic compatibility standards, and that interference which may prevent the device from working correctly will not occur. It is also possible that people with other types of devices, such as a hearing aids, could experience some discomfort.
- The wireless temperature sensor is magnetic. The magnetic elements in it may damage electronic implants, e.g. pacemakers or insulin pumps. People fitted with electronic implants should therefore not carry the temperature sensor in their pockets and always keep it at least 10 cm away from their pacemaker or similar medical device.

⚠ Warning – Risk of injury!

- When cooking in a bain marie, the hob and cooking container could shatter due to overheating. The cooking container in the bain marie must not directly touch the bottom of the water-filled pot. Only use heat-resistant cookware.
- Saucepans may suddenly jump due to liquid between the pan base and the hotplate. Always keep the hotplate and saucepan bases dry.
- Cookware and cooktops become very hot. Never reach across the hot cooktop or take hold of hot cookware.
- The wireless cooking sensor is equipped with a battery, which may become damaged if it is exposed to high temperatures. Remove the sensor from the cookware and store it away from any heat sources.
- The temperature sensor may be very hot when removing it from the saucepan. Wear oven gloves or use a tea towel to remove it.
- Unsuitable woks may cause accidents. Only use woks supplied by the manufacturer (available as optional accessories).

⚠ Warning – Risk of fault!

A fan is located on the underside of this hob. If a drawer is located on the underside of the hob, do not store any small or sharp objects, paper or tea towels in it. These may be sucked in and damage the fan or impair the cooling. There must be a clearance of at least 2 cm between the contents of the drawer and the fan entry point.

 Causes of damage**Caution!**

- Objects that are hard or sharp may damage the hob. Do not allow hard or sharp objects to fall on the hob.
- Heating cookware when empty may cause surface damage. Never leave empty cookware on the heat.
- Hot pots or pans may damage the hob. Never place hot pots or pans on the control panel, the displays/ indicators, the hob surround or the filter cover.
- Never leave aluminium foil or plastic containers on hot hotplates as this may damage the hob. Do not use oven liners.
- Risk of damage: Risk of breaking the filter cover. Take the filter cover off with care. Do not drop the filter cover.
- Using unsuitable cleaning products may cause surface damage, discolouration and stains. Only use cleaning products that are suitable for this type of hob.
- Friction from pots and pans may cause surface damage and discolouration. Always lift pots and pans up before repositioning them; do not slide them across the surface of the hob.
- Burnt-on food may cause surface damage and staining. Immediately remove any food that has boiled over using a glass scraper.
- Salt, sugar and sand may cause surface damage. Do not use the hob as a work surface or storage space.
- Using cookware with a rough base may cause surface damage. Check all cookware before use.
- Sugar and foods with a high sugar content may cause surface damage or conchoidal fracturing. Immediately remove any food that has boiled over using a glass scraper.

Environmental protection

In this section, you can find information about saving energy and disposing of the appliance.

Saving energy

- Always place suitable lids on saucepans. Cooking without a lid consumes significantly more energy. Use a glass lid so that you can see into the pan without having to lift the lid.
- Use pots and pans with flat bases. Uneven bases increase the energy consumption.
- The base diameter of pots and pans should be the same size as the hotplate. Please note: Cookware manufacturers often specify the diameter of the top of the saucepan, which is usually larger than the diameter of the base of the saucepan.
- Use small saucepans for small quantities. Using a large saucepan with little in it consumes a lot of energy.
- Cook with only a little water. This will save energy and preserve the vitamins and minerals in vegetables.
- Switch back to a lower heat setting in good time. This will save energy.
- During cooking, ensure that there is a sufficient supply of air to enable the ventilation system to work efficiently and with a low level of operating noise.
- Adjust the fan speed to the amount of steam produced during cooking. Only use intensive mode when required. The lower the fan speed, the less energy is consumed.
- If cooking produces large amounts of steam, select a higher fan speed in good time. If the cooking steam has already spread around the kitchen, the ventilation system will need to be operated for longer.
- Switch the appliance off when you are not using it.
- Clean and (if required) replace the filter at regular intervals in order to increase the effectiveness of the ventilation system and to prevent the risk of fire.

Environmentally-friendly disposal

Dispose of packaging in an environmentally-friendly manner.



This appliance is labelled in accordance with European Directive 2012/19/EU concerning used electrical and electronic appliances (waste electrical and electronic equipment - WEEE). The guideline determines the framework for the return and recycling of used appliances as applicable throughout the EU.

Induction cooking

Advantages of induction cooking

Induction cooking is very different from traditional cooking methods, as heat builds up directly in the item of cookware. This offers numerous advantages:

- Saves time when boiling and frying.
- Saves energy.
- Easier to care for and clean. Spilled food does not burn on as quickly.
- Heat control and safety – the hob increases or decreases the heat supply as soon as the user changes the setting. The induction hotplate stops the heat supply as soon as the cookware is removed from the hotplate, without having to switch it off first.

Cookware

Only use ferromagnetic cookware for induction cooking, such as:

- Cookware made from enamelled steel
- Cookware made from cast iron
- Special induction-compatible cookware made from stainless steel.

To check whether your cookware is suitable for induction cooking, refer to the section entitled → "Cookware check".

To achieve a good cooking result, the ferromagnetic area on the base of the pan should match the size of the hotplate. If a hotplate does not detect an item of cookware, try placing it on another hotplate with a smaller diameter.

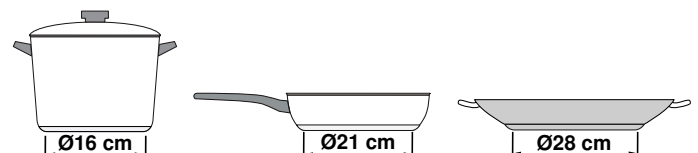

If the flexible cooking zone is being used as a single hotplate, larger items of cookware can be used as these are particularly suited to this area. You can find information on positioning cookware in the section entitled → "Flex Zone" on page 18.



Some induction cookware does not have a fully ferromagnetic base:

- If the base of the cookware is only partially ferromagnetic, only the area that is ferromagnetic will heat up. This may mean that heat will not be distributed evenly. The non-ferromagnetic area may not heat up to a sufficient temperature for cooking.

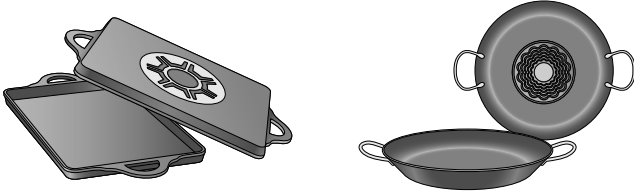

- The ferromagnetic area will also be reduced if the material from which the base of the cookware is made contains aluminium, for example. This may mean that the cookware will not become sufficiently hot or even that it will not be detected.

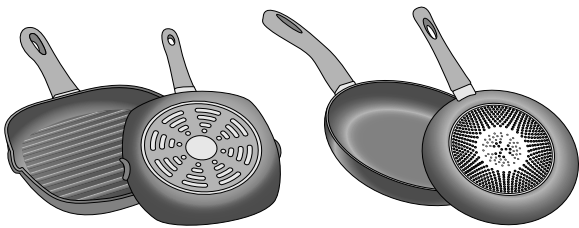

Unsuitable pans

Never use diffuser hobs or pans made from:

- common thin steel
- glass
- earthenware
- copper
- aluminium

Properties of the base of the cookware

The material(s) from which the base of the cookware is made can affect the cooking result. Using pots and pans made from materials that distribute heat evenly through them, such as stainless-steel pans with a three-layer base, saves time and energy.

Use cookware with a flat base; if the base of the cookware is uneven, this may impair the heat supply.

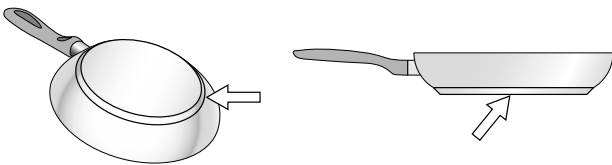

Absence of pan or unsuitable size

If no pan is placed on the selected hotplate, or if it is made of unsuitable material or is not the correct size, the power level displayed on the hotplate indicator will flash. Place a suitable pan on the hotplate to stop the flashing. If this takes more than 90 seconds, the hotplate will switch off automatically.

Empty pans or those with a thin base

Do not heat empty pans, nor use pans with a thin base. The hob is equipped with an internal safety system. However, an empty pan may heat up so quickly that the "automatic switch off" function may not have time to react and the pan may reach very high temperatures. The base of the pan could melt and damage the glass on the hob. In this case, do not touch the pan and switch the hotplate off. If it fails to work after it has cooled down, please contact the Technical Assistance Service.

Pan detection

Each hotplate has a lower limit for pan detection. This depends on the diameter of the ferromagnetic area of the cookware and the material from which its base is made. For this reason, you should always use the hotplate that best matches the diameter of the base of the pan.

Getting to know your appliance

You can find information on the dimensions and power of the hotplates in → Page 2

Your new appliance

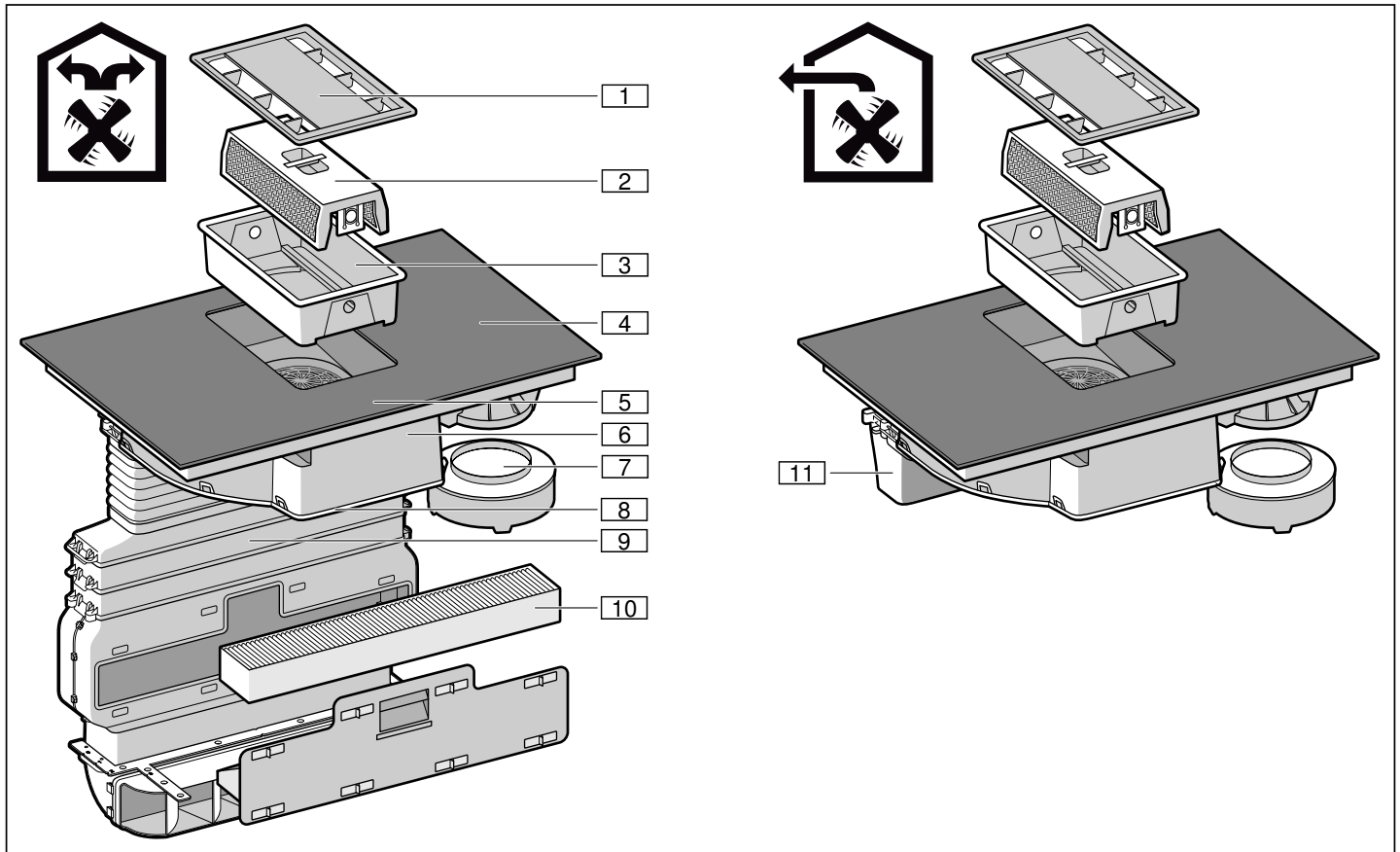

No.	Name
1	Filter cover
2	Metal grease filter
3	Container
4	Hob
5	Control panel
6	Fan housing
7	Overflow container
8	Housing cover
9	Piping*
10	Activated charcoal filter*
11	Exhaust pipe**

* in air recirculation mode only
 ** in air extraction mode only

In this section, we will explain the indicators and controls. You will also find out about the various functions of your appliance.

Special accessories

Air extraction set	HZ381400
Air recirculation set	HZ381500
Activated charcoal filter	HZ381700

Suitable cookware

There are pans that are optimally suited for the frying sensor function. They can be purchased from specialist retailers or through our technical after-sales service. Always quote the relevant reference number.

15 cm frying pan	HZ390210
19 cm frying pan	HZ390220
21 cm frying pan	HZ390230

The control panel

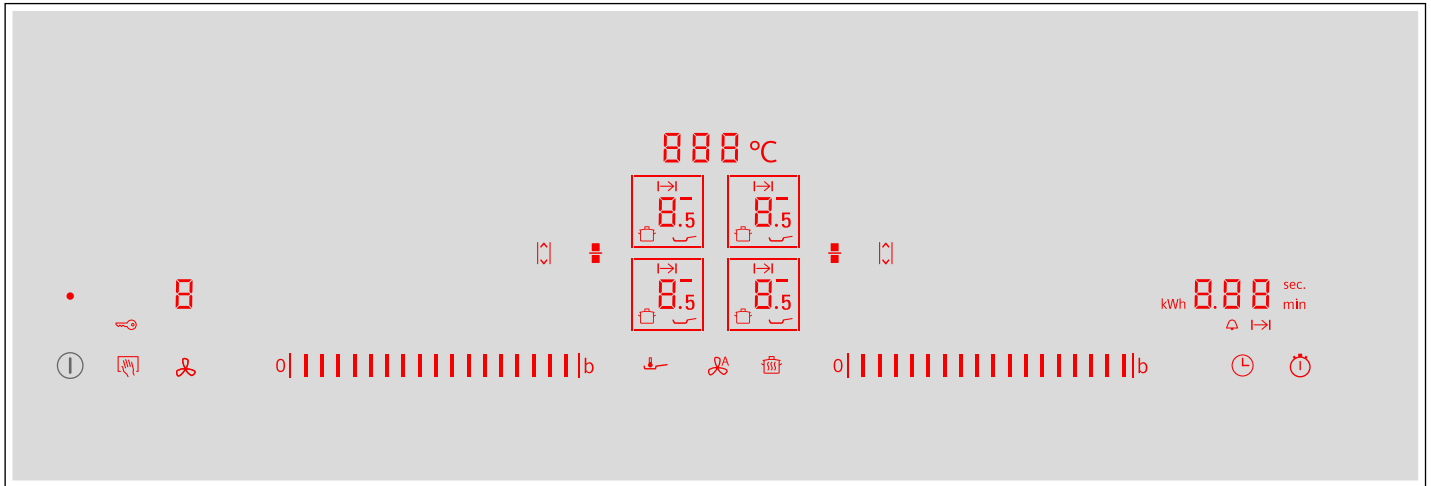

Touch controls

	Switch the appliance on and off
	Lock the control panel for cleaning and switch on the childproof lock
	Switch between the settings areas for the hob and the ventilation system/reset the saturation indicators
	Select a hotplate
	Apply heat settings/select fan settings 1-9 on the left-hand settings area
	Switch on the PowerBoost and ShortBoost functions for heat settings/intensive mode for the ventilation system
	Switch on the frying sensor
	Switch on automatic mode for the ventilation system
	Switch on the keep-warm function
	Programme the cooking time and kitchen timer
	Switch on the stopwatch function
	Activate the Move function
	Switch on the flexible cooking zone

Indicators/symbols

	Operating status
	Heat settings/fan settings
	Residual heat
	PowerBoost function/intensive mode for ventilation
	ShortBoost function
	Keep-warm function
	Frying sensor
	Cooking functions
	Temperature for cooking functions
	Childproof lock
	Timer function
	Set the cooking time
	Timer

Indicators/symbols

	Transferring settings
	Timer displays
	Energy consumption
	Ventilation system automatic mode
	Metal grease filter saturation indicator
	Activated charcoal filter saturation indicator

Controls

When the hob heats up, the symbols for the controls available at this time light up.

Touching a symbol activates the respective function.

Notes

- The corresponding symbols for the controls light up depending on whether they are available. The displays for the hotplates or the selected functions get brighter.
- Always keep the control panel clean and dry. Moisture can prevent it from working properly.
- Do not place any cookware near the indicators or sensors. The electronics could overheat.

Residual heat indicator

The hob has a residual heat indicator for each hotplate. This indicates that a hotplate is still hot. Do not touch a hotplate while the residual heat indicator is lit up.

The following indicators are shown depending on the amount of residual heat:

- Display **H**: High temperature
- Display **h**: Low temperature

If you remove the cookware from the hotplate during cooking, the residual heat indicator and the selected heat setting will flash alternately.

When the hotplate is switched off, the residual heat indicator will light up. Even after the hob has been switched off, the residual heat indicator will stay lit for as long as the hotplate is still warm.

Cooking sensor function (optional)

Depending on the appliance version, the temperature sensor will either be supplied with the appliance as a standard accessory or will be available to order as an optional accessory using the article no. below.

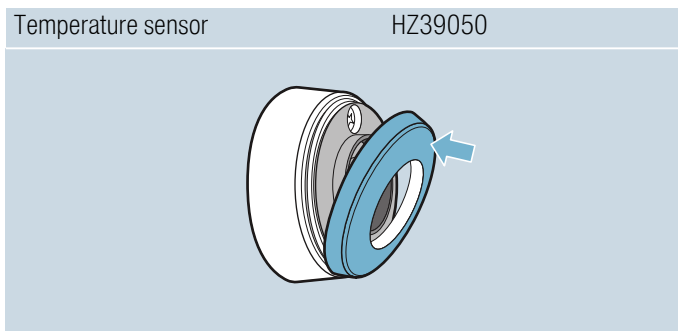

Operating modes

This appliance can be used in exhaust-air mode or circulating-air mode.

Exhaust air mode



The air which is drawn in is cleaned by the grease filters and conveyed to the exterior by a pipe system.

Note: The exhaust air must not be conveyed into a functioning smoke or exhaust gas flue or into a shaft which is used to ventilate installation rooms which contain heat-producing appliances.

- Before conveying the exhaust air into a non-functioning smoke or exhaust gas flue, obtain the consent of the heating engineer responsible.
- If the exhaust air is conveyed through the outer wall, a telescopic wall box should be used.

Circulating-air mode



The air which is drawn in is cleaned by the grease filters and an activated carbon filter and conveyed back into the kitchen.

Note: To bind odours in circulating-air mode, you must install an activated carbon filter. The different options for operating the appliance in circulating-air mode can be found in the brochure. Alternatively, ask your dealer. The required accessories are available from specialist outlets, from customer service or from the Online Shop.

Before using for the first time

Please read the following information before using the appliance for the first time:

Clean the appliance and all accessory parts thoroughly.

Before you can use your new appliance, you must apply certain settings.

Initial use

Note: When it is delivered, the appliance is preset to air recirculation mode.

Possible settings:

- In air recirculation mode, if **[17]** is displayed, the value **0** (factory setting) is set.
- In air extraction mode, if **[17]** is displayed, the value **1** is set.

To switch the appliance to air extraction mode, see → "Basic settings" on page 36.

Operating the appliance

This chapter explains how to set a hotplate. The table shows heat settings and cooking times for various meals.

Warning – Risk of burns!

The filter cover will get very hot very quickly if left on the hob. Never place the filter cover on the hob. Do not place pots, pans or other hot objects on the filter cover.

Note: Switch on the ventilation system when you start cooking and switch it off again a few minutes after you have finished cooking. This is the most effective way of removing steam from the kitchen.

Note: Never use the appliance without the container, metal grease filter or filter cover.

Switching the hob on and off

Switch the hob on and off using the main switch.

To switch on: Touch the  symbol. An audible signal sounds. The symbols for the hotplates and the functions available at this time light up. The hob is ready to use.

To switch off: Touch the  symbol until the indicators go out. The residual heat indicator remains lit until the hotplates have cooled down sufficiently.

Notes

- The hob will automatically switch itself off if all hotplates have been switched off for more than 30 seconds and the ventilation system is off.
- The selected settings are stored for 4 seconds after the hob has been switched off. If you switch it back on during this time, the hob will operate using the stored settings.

Applying hotplate settings

Set the required heat setting on the control panel.

Heat setting 1 = lowest setting.



Heat setting 9 = highest setting.

Every heat setting has an intermediate setting. This is designated .

Note: The left-hand hotplates are set in the settings area on the left and the right-hand hotplates are set in the settings area on the right.

Selecting a hotplate and heat setting

The hob must be switched on.

1. Touch the  and  symbols for the required hotplate.
The  indicator gets brighter.
2. Swipe your finger over the relative settings area until the required heat setting lights up.

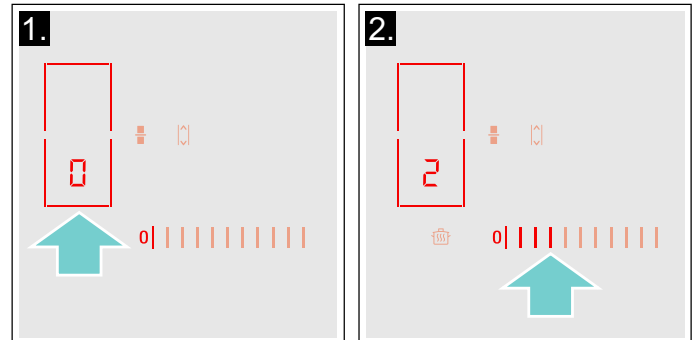

The heat setting is set.

Changing the power level

Select the hotplate and set the desired power level in the programming zone.

Switch off the hotplate

Select the hotplate and set it to  in the programming panel. The hotplate turns off and the residual heat indicator appears.

Notes

- If no pan has been placed on the hotplate, the selected power level flashes. After a certain time has elapsed, the hotplate switches off.
- If a pan has been placed on the hotplate before switching on the hob, it will be detected within 20 seconds of pressing the main switch and the hotplate will be selected automatically. Once detected, select the power level within the next 20 seconds or the hotplate will switch off.
- The ventilation system must be switched off separately. → "Switching off the ventilation system" on page 14

Switching the ventilation system on and off

Note: Always adjust the setting according to the current conditions. To eliminate strong cooking smells, select a high fan setting.





Note: If no metal grease filter is available, the ventilation system cannot be switched on. Insert the metal grease filter. The hob functions are also available if there is no metal grease filter. → "Cleaning" on page 39



Note: Do not obstruct the ventilation openings. Do not place objects on the filter cover, as this will reduce the power of the ventilation system.

Note: Using tall items of cookware may prevent the extraction system from working at optimum power. The extraction power can be improved by placing a lid on the cookware at an angle.

Note: When you switch on the ventilation system, the right-hand settings area is no longer available. You can change the fan setting for the ventilation system in the left-hand settings area.

Switching on the ventilation system

Note: If the  and  symbols are not available, insert the metal grease filter correctly. The  and  symbols are available. The ventilation system can be switched on.

1. Touch the  symbol.
The ventilation system starts at fan setting . The setting that is selected will be shown on the display panel and in the left-hand settings area. The right-hand settings area is not available.

Notes

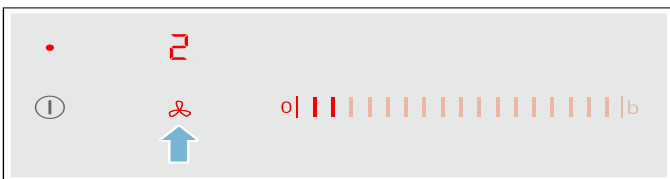

- Heat settings cannot be changed while the setting is being applied for the ventilation system.
 - During a period of a few seconds, a fan setting for the ventilation system can be selected. The settings area can then be used for selecting the heat settings again.
2. Select the required setting from the settings area. The setting that is selected will be displayed in the left-hand settings area.



3. To set a different setting, touch the  symbol and select the required setting from the settings area. The setting that is selected will be displayed in the left-hand settings area.

Switching off the ventilation system

If you want to switch off the appliance, touch the  symbol. If you only want to switch off the ventilation system, proceed as follows:



1. Touch the  symbol.
2. Select the  symbol in the settings area.
3. Touch the  symbol to switch to the setting area for the hob.



Note: The run-on will start once the appliance has been switched off (depending on the basic settings selected).

Intensive setting

Activate intensive mode if strong odours or large amounts of steam are produced. In this mode, the ventilation system briefly operates at maximum power. It automatically switches back to a low setting after a short time.

Switching on

1. Touch the  symbol.
2. Touch the  symbol.

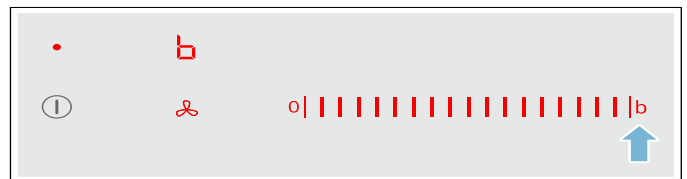

The  symbol and the symbols in the left-hand settings area will be lit.  is shown on the display panel. Intensive mode is now activated.



Note: After eight minutes, the appliance automatically switches back to fan setting .

Note: After a few seconds, the settings area for the heat settings will be displayed again.

Switching off

1. Touch the  symbol.
2. In the next few seconds, slide your finger over the settings area until setting  or another setting is displayed.

Automatic start

Depending on the basic settings selected, the following options will be available once you have selected the fan setting for a cooking zone:

- The ventilation system will not start.
- The ventilation system will start at the fan setting selected by the sensor.
- The ventilation will start at a specified fan setting.

Select the option you want to use in the basic settings. The basic settings also offer the option to adjust the sensitivity of the sensor. → "Basic settings" on page 36

Automatic mode with sensor control

Switching on

Touch the  symbol.

The optimum setting is set automatically using a sensor.  will be shown on the display panel.

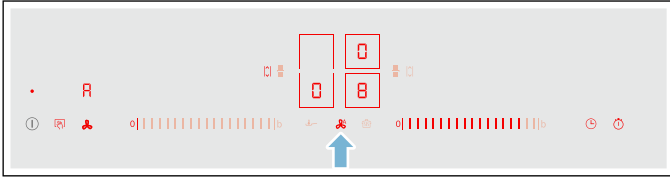

Switching off

Touch the  symbol.

The fan setting that was last selected by the sensor will be shown on the display panel. Automatic mode is switched off.



Run-on function

The run-on function leaves the ventilation system running for a few minutes after it has been switched off. This eliminates any remaining cooking smells. The ventilation system will switch off automatically afterwards.

In the basic settings, you can select the following options for the run-on:

- Deactivate the run-on
- Activate the automatic function with sensor-controlled run-on
- Activate the run-on for a fixed period at a fixed fan setting

Note: The run-on function will only switch on if at least one cooking zone has been switched on for at least 1 minute.

If the automatic function with sensor-controlled run-on has been activated, the  and  symbols will be lit during the run-on period.

Switching off

Touch the  symbol.

This will deactivate the run-on function immediately.

If one of the following conditions is present, the run-on function is switched off:

- The run-on time has expired.
- The appliance is switched on again.
- When the automatic function is activated with a sensor-controlled run-on, the sensor determines a corresponding room-air quality level.

Chef's recommendations

Recommendations

- When heating up puree, cream soups and thick sauces, stir occasionally.
- Set heat setting 8 to 9 for preheating.
- When cooking with the lid on, turn the heat setting down as soon as steam escapes between the lid and the cookware. Steam does not need to escape for a good cooking result.
- After cooking, keep the lid on the cookware until you serve the food.
- To cook with the pressure cooker, observe the manufacturer's instructions.
- Do not cook food for too long, otherwise the nutrients will be lost. The kitchen clock can be used to set the optimum cooking time.
- For a more healthy cooking result, smoking oil should be avoided.
- To brown food, fry small portions in succession.
- Cookware may reach high temperatures while the food is cooking. We recommend that you use oven gloves.
- You can find recommendations for energy-efficient cooking in section → "Environmental protection"

Cooking table

The table shows which heat setting is suitable for each type of food. The cooking time may vary depending on the type, weight, thickness and quality of the food.

	Heat setting	Cooking time (mins)
Melting		
Chocolate coating	1 - 1.5	-
Butter, honey, gelatine	1 - 2	-
Heating and keeping warm		
Stew, e.g. lentil stew	1.5 - 2	-
Milk*	1.5 - 2.5	-
Heating sausages in water*	3 - 4	-
Defrosting and heating		
Spinach, frozen	3 - 4	15 - 25
Goulash, frozen	3 - 4	35 - 55
Poaching, simmering		
Potato dumplings*	4.5 - 5.5	20 - 30
Fish*	4 - 5	10 - 15
White sauces, e.g. Béchamel sauce	1 - 2	3 - 6
Whisked sauces, e.g. sauce béarnaise, hollandaise	3 - 4	8 - 12
Boiling, steaming, braising		
Rice (with double the volume of water)	2.5 - 3.5	15 - 30
Rice pudding***	2 - 3	30 - 40
Unpeeled boiled potatoes	4.5 - 5.5	25 - 35
Boiled potatoes	4.5 - 5.5	15 - 30
Pasta, noodles*	6 - 7	6 - 10
Stew	3.5 - 4.5	120 - 180
Soups	3.5 - 4.5	15 - 60
Vegetables	2.5 - 3.5	10 - 20
Vegetables, frozen	3.5 - 4.5	7 - 20
Cooking in a pressure cooker	4.5 - 5.5	-
Braising		
Roulades	4 - 5	50 - 65
Pot roast	4 - 5	60 - 100
Goulash***	3 - 4	50 - 60
* Without lid		
** Turn several times		
*** Preheat to heat setting 8 - 8.5		

	Heat setting	Cooking time (mins)
Roasting/frying with little oil*		
Escalope, plain or breaded	6-7	6-10
Escalope, frozen	6-7	6-12
Chop, plain or breaded**	6-7	8-12
Steak (3 cm thick)	7-8	8-12
Poultry breast (2 cm thick)**	5-6	10-20
Poultry breast, frozen**	5-6	10-30
Rissoles (3 cm thick)**	4.5-5.5	20-30
Hamburgers (2 cm thick)**	6-7	10-20
Fish and fish fillet, plain	5-6	8-20
Fish and fish fillet, breaded	6-7	8-20
Fish, breaded and frozen, e.g. fish fingers	6-7	8-15
Scampi, prawns	7-8	4-10
Sautéing fresh vegetables and mushrooms	7-8	10-20
Stir-fry, vegetables, meat cut in Asian-style strips	7-8	15-20
Stir fry, frozen	6-7	6-10
Pancakes (baked in succession)	6.5-7.5	-
Omelette (cooked in succession)	3.5-4.5	3-10
Fried eggs	5-6	3-6
Deep-fat frying* (150-200 g per portion in 1-2 l oil, deep-fat fried in portions)		
Frozen products, e.g. chips, chicken nuggets	8-9	-
Croquettes, frozen	7-8	-
Meat, e.g. chicken portions	6-7	-
Fish, breaded or in beer batter	6-7	-
Vegetables, mushrooms, breaded or battered, tempura	6-7	-
Small baked items, e.g. doughnuts, fruit in batter	4-5	-
* Without lid		
** Turn several times		
*** Preheat to heat setting 8 - 8.5		

Flex Zone

You can use each flex zone as a single hotplate or as two independent hotplates, as required.

It consists of four inductors that work independently of each other. If using the flexible cooking zone, only the area that is covered by cookware is activated.

Advice on using cookware

To ensure that the cookware is detected and heat is distributed evenly, correctly centre the cookware:

As a single hotplate

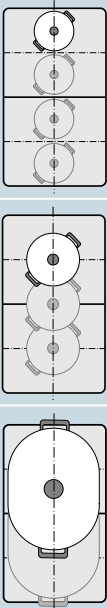

Diameter smaller than or equal to 13 cm
Place the cookware on one of the four positions that can be seen in the illustration.

Diameter greater than 13 cm
Place the cookware on one of the three positions that can be seen in the illustration.

If the cookware takes up more than one hotplate, place it starting on the upper or lower edge of the flexible cooking zone.

As two independent hotplates

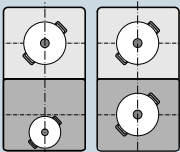

The front and rear hotplates each have two inductors and can be used independently of each other. Select the required heat setting for each of the hotplates. Use only one item of cookware on each hotplate.

As a single hotplate

The flexible cooking zone is activated as a single hotplate.

Activating

1. Select the flexible cooking zone by touching the  symbol.
2. Select the required heat setting from the settings area.

The flexible cooking zone has now been activated.

Changing the heat setting

Select the hotplate and change the heat setting in the relative settings area.

Adding a new item of cookware

Set the new piece of cookware down on the hotplate and then touch the  symbol twice. The new piece of cookware will be detected and the heat setting that was previously selected will be retained.

Note: If the cookware is moved to the hotplate being used or lifted up, the hotplate begins an automatic search and the heat setting selected previously is retained.

Deactivating



Touch the  symbol.

This deactivates the flexible cooking zone. The two hotplates will now function independently.

As two independent hotplates

Use the flexible cooking zone as two independent hotplates.

Disconnecting hotplates

1. Touch the  symbol.
2. Select the required hotplate by touching the  symbol.
3. Select the required heat setting from the settings area.

The hotplate is activated.

Notes

- If the hob switches itself off and then on again, the flexible cooking zone is used as a single hotplate again.
- To change the configuration settings for the flexible cooking zone, refer to section → "Basic settings".

Linking the two hotplates

Touch the  symbol.

The flexible cooking zone has now been activated.

Move function

This function activates the entire flexible cooking zone, which is divided into three cooking areas and which has preset heat settings.

Only use one item of cookware. The size of the cooking area depends on the cookware used and whether it is positioned correctly.

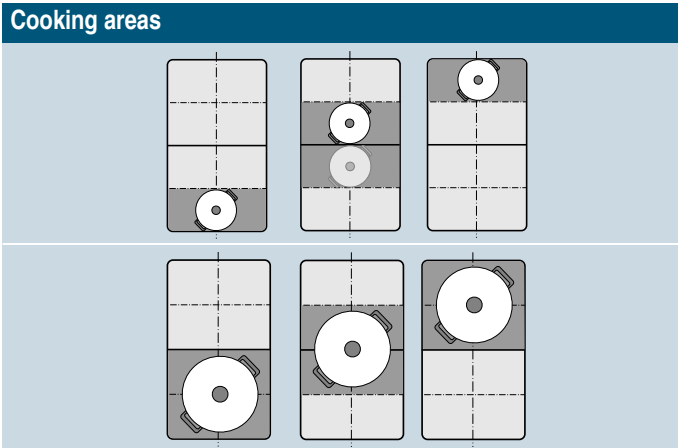

This means that an item of cookware can be moved during the cooking process to another cooking area with another heat setting:

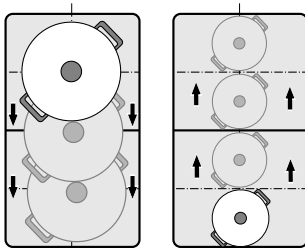

Preset heat settings:

Front area = heat setting **9**

Middle area = heat setting **5**

Rear area = heat setting **1.5**

The preset heat settings can be changed independently of one another. You can find out how to change these in the section on → "Basic settings".

Notes

- If more than one item of cookware is detected on the flexible cooking zone, the function is deactivated.
- If the cookware is moved within the flexible cooking zone or lifted up, the hob automatically starts searching and the heat setting of the area in which the vessel was detected is set.
- You can find information on the size and positioning of the cookware in the section on → "Flex Zone"

Activation

1. Select one of the two hotplates in the flexible cooking zone.
2. Touch the  symbol; it lights up more brightly. The flexible cooking zone is activated as a single hotplate. The heat setting in the area in which the cookware is located lights up in the hotplate display. The function has now been activated.

Changing the heat setting

The heat settings for the individual cooking areas can be changed during the cooking process. Set the cookware down on the cooking area and change the heat setting in the settings range.

Notes

- Only the heat setting in the area in which the cookware is located is changed.
- If the function is deactivated, the heat settings for the three cooking areas are reset to the preset values.

Deactivating

Touch the  symbol. It lights up dimly.

The function was deactivated.

Note: If one of the cooking areas is set to , the function deactivates after a few seconds.

Time-setting options

Your hob has three timer functions:

- Programming the cooking time
- Kitchen timer
- Stopwatch function

Programming the cooking time

The hotplate automatically switches off after the time that is set has elapsed.

Setting procedure:

1. Touch the ⏸ symbol twice.  and the I→ indicator light up in the timer display.
2. Select the hotplate. The I→ indicator lights up.
3. Within the next 10 seconds, set the required cooking time in the settings range.

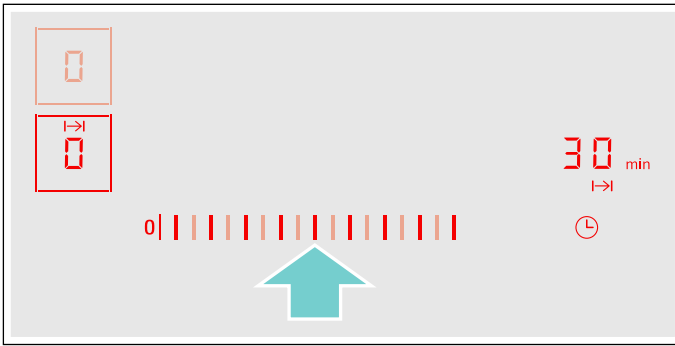

4. Touch the ⏸ symbol to confirm the selected setting.
5. Select the required heat setting.

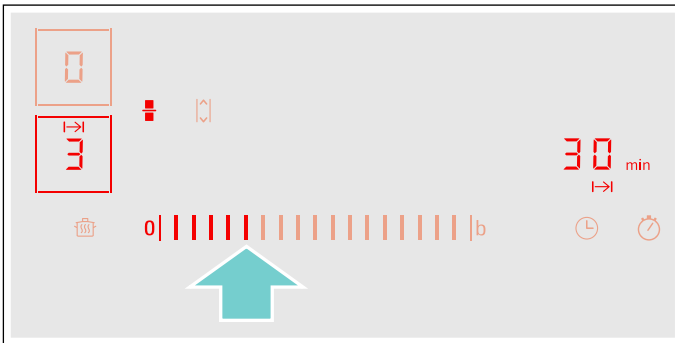

The cooking time begins to elapse.

Notes

- The same cooking time can be set automatically for all hotplates. The set time for each of the hotplates counts down independently. You can find information on automatically programming the cooking time in section → "Basic settings"
- If the flexible cooking zone is selected as the only hotplate, the set time for the entire cooking zone is the same.
- If the Move function is selected for the combined hotplate, the set time for the three hotplates is the same.

Frying sensor

If a cooking time has been programmed for a hotplate and the frying sensor has been activated, the cooking time will not begin to count down until the selected temperature setting has been reached.

Cooking functions

If a cooking time has been programmed for a hotplate and one of the cooking functions has been activated, the set cooking time will not start to count down until the temperature for the selected area has been reached.

Changing or deleting the time

Touch the ⏸ symbol twice and then select the hotplate.

Change the cooking time in the settings area or set  to delete the programmed cooking time.

Touch the ⏸ symbol to confirm the selected setting.

When the time has elapsed

The hotplate switches itself off, the I→ indicator flashes and the hotplate displays . An audible signal sounds.

 and the I→ indicator flash in the timer display.

When the ⏸ symbol is touched, the indicators go out and the acoustic signal ceases.

Notes



- If a cooking time has been programmed for several hotplates, the shortest cooking time appears in the timer display.
- To query a hotplate's remaining cooking time, touch the ⏸ symbol twice and select the hotplate.
- You can set a cooking time of up to **99** minutes.

The kitchen timer

You can use the kitchen timer to set a time of up to 99 minutes.

This functions independently from the hotplates and from other settings. This function does not automatically switch off a hotplate.

Setting procedure

1. Touch the ⏸ symbol.  and the  indicator light up in the timer display.
2. Select the required time in the settings area and confirm this setting by touching the ⏸ symbol. After a few seconds, the time begins to elapse.



Changing or deleting the time

Touch the ⏸ symbol.

Change the cooking time in the settings area or set  to delete the programmed cooking time.

Touch the ⏸ symbol to confirm the selected setting.

When the time has elapsed

An audible signal sounds once the time has elapsed.  and the  symbol flash in the timer display.



The indicators go out after touching the ⏸ symbol.

Stopwatch function

The stopwatch function displays the time that has elapsed since activation.



This functions independently from the hotplates and from other settings. This function does not automatically switch off a hotplate.

Activating

Touch the  symbol.  light up in the timer display.

The cooking time begins to elapse.

Deactivating

Touch the  symbol.  appear in the timer display and then go out.

The function is deactivated.

Note: This function must be selected in order to deactivate the stopwatch.

PowerBoost function

The PowerBoost function enables you to heat up large quantities of water faster than when using heat setting .

This function can always be activated for a hotplate, provided the other hotplate in the same group is not in use (see illustration).

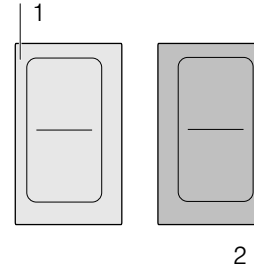

Note: The PowerBoost function can also be activated in the flexible area if the cooking zone is being used as a single hotplate.

Activating

1. Select a hotplate.
2. Touch the **b** symbol.
The **b** indicator lights up.
The function has now been activated.

Deactivating

1. Select a hotplate.
2. Touch the **b** symbol.
The **b** indicator goes out and the hotplate switches back to the  heat setting.
The function is deactivated.

Note: In certain circumstances, the PowerBoost function can switch itself off automatically in order to protect the electronic elements inside the hob.

ShortBoost function

The ShortBoost function enables you to heat cookware faster than when using heat setting **5**.

After deactivating the function, select the appropriate heat setting for your food.

This function can always be activated for a hotplate, provided the other hotplate in the same group is not in use (see illustration).

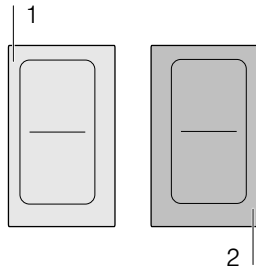

Note: With the flexible cooking zone, the ShortBoost function can be activated even if it is used as the only cooking zone.

Recommendations for use

- Always use cookware that has not been pre-heated.
- Use pots and pans with a flat base. Do not use cookware with a thin base.
- Never leave empty cookware, oil, butter or lard to heat up unattended.
- Do not place a lid on the cookware.
- Place the cookware on the centre of the hotplate. Ensure that the diameter of the base of the cookware corresponds to the size of the hotplate.
- You can find information on the type, size and positioning of the cookware in section → "Induction cooking"

Activating

1. Select a hotplate.
2. Touch the **b** symbol twice.
The **b** indicator lights up.
The function has now been activated.

Deactivating



1. Select a hotplate.
2. Touch the **b** symbol.
The **b** indicator goes out and the hotplate switches back to the **5** heat setting.
The function is deactivated.

Note: After 30 seconds, this function will automatically switch off.



Keep warm function

This function is suitable for melting chocolate or butter and for keeping food warm.

Activating

1. Touch the  symbol.
2. Select the required hotplate within the next 10 seconds.
The  indicator lights up.
The function has now been activated.

Deactivating

1. Touch the  symbol.
2. Select a hotplate.
The  indicator goes out. The hotplate switches itself off and the residual heat indicator lights up.
The function is deactivated.

Transferring settings

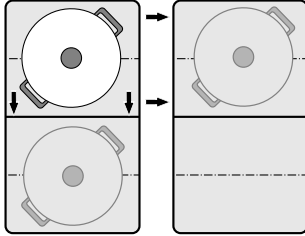

This function can be used to transfer the heat setting, the programmed cooking time and the selected cooking function from one hotplate to another.

To transfer the settings, move the cookware from the hotplate which is switched on to another hotplate.



Note: You can find additional information on the positioning of the cookware in the section on → "Flex Zone"

Activation

1. Move the cookware from the hotplate which is switched on to another hotplate.
The heat setting of the original hotplate flashes.
The cookware is detected and the previously selected heat setting and the  symbol flash in the new hotplate display.
2. Select the new hotplate to confirm the settings.
The heat setting of the original hotplate is set to .

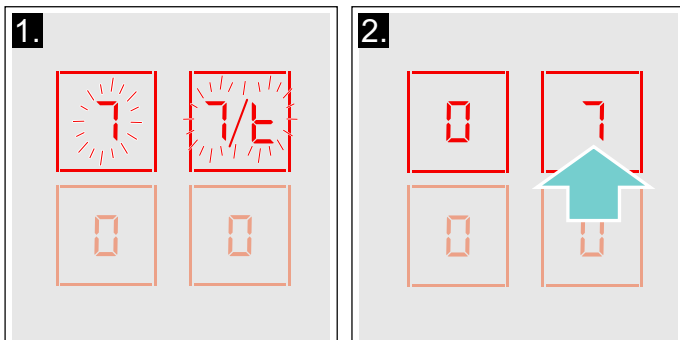

The settings have been transferred to the new hotplate.

Notes

- Move the cookware to a hotplate which is not switched on, which you have not yet preset or on which no other cookware has been placed.
- The PowerBoost or ShortBoost function can then only be moved from left to right or right to left if no hotplate is active.
- If a new item of cookware is set down on another hotplate before the settings have been confirmed, this function is ready for both cooking vessels.
- If several vessels are moved, the function is only ready for the vessel which was last moved.

Cooking assist functions

The cooking assistance functions make cooking easy and always give you excellent results. The recommended temperature settings are suitable for any type of cooking.

They enable you to cook without using excessive heat and promise the perfect cooking and frying results.

Sensors measure the heat of the saucepan or frying pan throughout the cooking process. This ensures that the power is continuously controlled and that the right temperature is maintained.

Food can be added once the selected temperature has been reached. Food will not be overheated and liquids will not boil over.

The hotplates that have a frying sensor are marked with the frying sensor symbol.

The cooking functions are available to all hotplates if a wireless temperature sensor is connected.











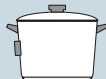

In this section, you will find information on:

- Cooking assistant function types
- Suitable cookware
- Sensors and special accessories
- Functions and heat settings
- Recommended dishes

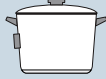
Cooking assistant function types

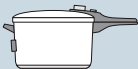
The cooking assistance functions are used to select the best cooking type for each kind of food.

The table shows the various different function settings that are available for the cooking assistants:

Cooking assistance functions	Temperature settings	Cookware	Available for	Activate
Frying sensor				
Roasting/frying with a small amount of oil	1, 2, 3, 4, 5			
Cooking functions				
Heating/keeping warm	1/70 °C		All hotplates	
Poaching	2/90 °C		All hotplates	
Cooking	3/100 °C		All hotplates	
Cooking in a pressure cooker	4/120 °C		All hotplates	
Frying with a large amount of oil in the saucepan*	5/170 °C		All hotplates	

*Preheat with the lid on and fry with the lid off.

If the hob does not have a wireless temperature sensor, this can be purchased from specialist retailers or through our technical after-sales service.

Suitable cookware

Select the hotplate with the diameter that most closely matches that of the base of the cookware and place the cookware in the centre of this hotplate.

The cooking functions are not suitable for frying food in a pan like you can with the frying sensor.

There are frying pans that are perfect for using with the frying sensor. These can be purchased from specialist retailers or through our technical after-sales service. Always quote the relevant reference number:

- HZ390210 15 cm frying pan.
- HZ390220 19 cm frying pan.
- HZ390230 21 cm frying pan.

These frying pans have a non-stick coating so that you can fry food with only a small amount of oil.

Notes

- The frying sensor has been configured specifically for this type and size of frying pan.
- Using a frying pan of a different size or one that is poorly positioned on the flexible cooking zones may result in the frying sensor not being activated. See the section entitled → "Flex Zone".
- Other frying pans may overheat and reach a temperature above or below the selected temperature setting. Try the lowest heat setting to begin with and change it if necessary.

Any cookware that is suitable for induction cooking can be used with the cooking functions. You can find information on which types of cookware can be used with an induction hob in the section entitled → "Induction cooking".

The cooking assistance functions table shows which cookware is suitable for which functions.

Sensors and special accessories

The sensors measure the temperature of the pot throughout the entire cooking process. This ensures that the cooking power is controlled with high precision to maintain the correct temperature and achieve optimum cooking results.

Your hob has two different temperature-measuring systems for achieving the best results:

- Temperature sensors that are located inside the hob and monitor the temperature of the base of the cookware. Suitable for the frying sensor.
- A wireless cooking sensor that transmits information about the temperature of the cookware to the control panel. Suitable for the cooking functions.

The cooking sensor is essential for using the cooking functions.

If your hob does not have a wireless cooking sensor, this can be purchased from specialist retailers, our technical after-sales service or our official website by quoting the reference number HZ39050.



You can find information about the cooking sensor in section → *"Preparing and maintaining the wireless temperature sensor"*

Temperature settings

Temperature level	Suitable for
1 very low	Preparing and reducing sauces, stewing vegetables and frying food in extra virgin olive oil, butter or margarine.
2 low	Frying food in extra virgin olive oil, butter or margarine, e.g. omelettes.
3 medium - low	Frying fish and thick food such as meatballs and sausages.
4 medium - high	Frying steaks (well done), breaded frozen products, and thin food such as schnitzel, strips of meat and vegetables.
5 high	Frying food at high temperatures, e.g. rare steaks (rare or medium), potato fritters and fried potatoes.

Setting procedure

Select the appropriate temperature level from the table. Set an empty item of cookware down on the cooking zone.

1. Touch the  symbol.
2. Select the hotplate. The  indicator lights up in the hotplate display.

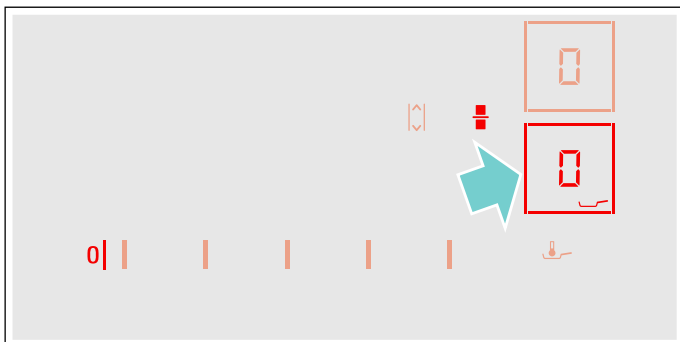

Functions and heat settings

Frying sensor

You can use the frying sensor when pan-frying food with a small amount of oil.

Hotplates with this function are marked with the frying sensor symbol.

Benefits

- The hotplate only heats up when necessary. This saves energy. Oil and fat will not overheat.
- A signal will sound once the empty frying pan has reached the optimum temperature for adding oil and food.

Notes

- Do not put the lid on the pan as this will prevent the controller from working. You can use a splatter guard to prevent the oil from spitting.
- Use oil or fat that is suitable for frying. If using butter, margarine, cold-pressed olive oil or lard, use temperature setting 1 or 2.
- Never leave fat or oil unattended while you are heating it.
- If the hotplate is a higher temperature than the cookware or vice versa, the temperature sensor will not be activated correctly.
- Always use the cooking functions when frying with a large amount of oil in the saucepan. "Frying with a large amount of oil in the saucepan", heat setting 5.

3. Within the next 10 seconds, select the required temperature setting from the settings range.

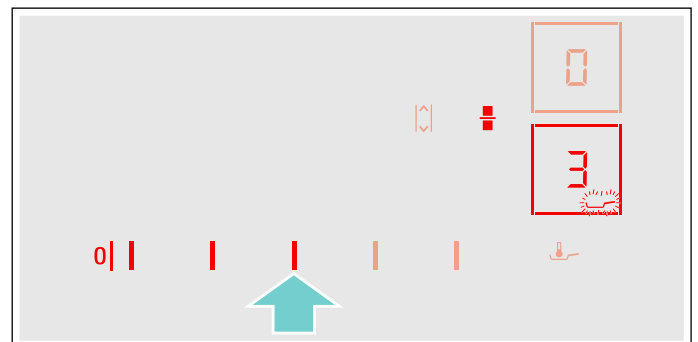

The function has now been activated.

The  temperature symbol flashes until the frying temperature is reached. A signal sounds and the temperature symbol stops flashing.

4. Once the frying temperature has been reached, add the fat and then the food to the pan.

Note: Turn the food so that it does not burn.

Switching off the frying sensor

Touch the  symbol and select the hotplate. The hotplate will switch off and the residual heat indicator will light up.

Cooking functions

You can use these functions to heat, simmer or cook food, or cook it in a pressure cooker or fry it in a saucepan with sufficient oil at a controlled temperature.

These cooking functions are available for all hotplates.

Benefits

- The cooking zone only continues heating for as long as this is necessary to maintain the temperature. This saves energy and prevents oil or fat from overheating.
- The temperature is continuously monitored. This prevents the food from spilling over. In addition, the temperature setting does not need to be changed.
- A signal sounds once the water or oil has reached the optimum temperature for adding the food. The table shows if the food needs to be added right at the start.

Temperature ranges and settings

Cooking functions	Temperature setting	Temperature range	Suitable for
Heating, keeping warm	1/70 °C	60 - 70 °C	E.g. soups, punch
Poaching	2/90 °C	80 - 90 °C	E.g. rice, milk
Cooking	3/100 °C	90 - 100 °C	E.g. pasta, vegetables
Cooking in a pressure cooker	4/120 °C	110 - 120 °C	E.g. chicken, stew.
Frying with a large amount of oil in the saucepan	5/170 °C	170 - 180 °C	E.g. doughnuts, meatballs

Tips for cooking with the cooking functions

- Heating/keep-warm function: Frozen products in portions, e.g. spinach. Place the frozen product in the cookware. Pour in the volume of water specified by the manufacturer. Cover the cookware and select the setting 1/70 °C. Stir occasionally.
- Poaching function: This function is suitable for cooking food at low temperatures and for thickening sauces and stews. Select setting 2/90 °C.
- Boiling function: This function allows you to boil water with a lid without it boiling over. You can boil efficiently thanks to the temperature control. Select setting 3/100 °C.
- Cooking in a pressure cooker function: Follow the manufacturer's recommendations. Continue cooking for the recommended time once the signal has sounded. Select setting 4/120 °C.
- Frying with a large amount of oil in the saucepan function: To heat the oil with the lid on. Remove the lid after the signal tone and add the food (insofar as there are no other instructions in the "Recommended dishes" table). Select setting 5/170 °C.

Notes

- Use pots and pans with a thick, flat base. Do not use pots and pans with a thin or domed base.
- Fill the pot so that the contents reach high enough to cover the cooking sensor's silicone patch.
- Use the frying sensor when frying with a small amount of oil.
- Position the cookware in such a way that the cooking sensor is pointing towards the outer side of the hob.
- Do not remove the cooking sensor from the pot during cooking.
- Remove the cooking sensor from the pot after cooking. Be careful as the cooking sensor may be very hot.

Notes

- Always cook with the lid on. Exception: "Frying with a large amount of oil in the saucepan", temperature setting 5/170 °C.
- If an audible signal does not sound, make sure that the lid is on the pan.
- Never leave oil unattended during heating. Use oil or fat that is suitable for frying. Do not mix different cooking fats together, e.g. oil and lard. Mixtures of different fats may froth up when hot.
- If you are not satisfied with the cooking result, e.g. when cooking potatoes, next time use less water but keep the recommended temperature setting.

Setting the boiling point

The point at which water starts to boil depends on the height of your home above sea level. You can set the boiling point if water is boiling too strongly or not strongly enough. To do this, proceed as follows:

- Select the basic setting **⌵ 4**; see the section on → "Basic settings"
- The basic setting is 3 as standard. If your home is between 200 and 400 metres above sea level, there is no need to set the boiling point. If not, choose the correct setting from the following table according to your altitude:

Height	Setting ⌵ 4
0 - 100 m.	1
100 - 200 m.	2
200 - 400 m.	3*
400 - 600 m.	4
600 - 800 m.	5
800 - 1000 m.	6
1000 - 1200 m.	7
1200 - 1400 m.	8
Above 1400 m.	9
* Basic setting	

Note: Temperature setting 3/100 °C is sufficient for efficient boiling, even if the water does not boil very strongly. However, the boiling point can be changed. For example, you can set a lower altitude if you want the water to boil more strongly.

Connecting the wireless temperature sensor to the control panel

To connect the wireless temperature sensor to the control panel, follow the instructions below:

1. Select the basic setting **⌵ 4**; see the section on → "Basic settings"
The indicator for one of the hotplates and the **—** indicator will light up. The control panels switch off.
2. Select the hotplate and its indicator will light up. A signal will sound. The **☰** indicator will flash.
3. Press the **☰** symbol on the wireless temperature sensor within 30 seconds.
After a few seconds, the status of the connection between the temperature sensor and the control panel will appear on the hotplate's display.

Status	
☰	Connected correctly
1	Not connected correctly: Transmission error.
2	Not connected correctly: Temperature sensor fault.

- The cooking functions are made available once the temperature sensor has been connected to the control panel correctly.
- If there is a fault with the temperature sensor, the connection may not be established correctly for the following reasons:
 - Bluetooth communication error.
 - You did not press the symbol on the temperature sensor within 30 seconds of selecting a hotplate.
 - The battery in the temperature sensor has run out.

Reset the wireless temperature sensor and follow the connection procedure once again.

- If the temperature sensor and the control panel are not connected correctly due to a transmission error, follow the connection procedure once again. If the display continues to show incorrect connection **1**, contact our technical after-sales service.

Resetting the wireless temperature sensor

1. Touch and hold the **☰** symbol for approximately 8-10 seconds.
While you are doing this, the temperature sensor's LED indicator will light up three times. When the LED lights up for the third time, it will start to reset the temperature sensor. At this point, you will need to lift your finger off the symbol.
Once the LED goes out, this means that the wireless temperature sensor has been reset.
2. Repeat the connection procedure from point 2.

Setting procedure

1. Attach the temperature sensor to the saucepan; see the section on → "Preparing and maintaining the wireless temperature sensor"
2. Place a saucepan filled with sufficient liquid on the required hotplate and always put the lid on.
3. Press the **☰** symbol on the wireless temperature sensor. The **☰** symbol for all hotplates will light up on the control panel.
4. Select the hotplate on which you have placed the saucepan with the temperature sensor.

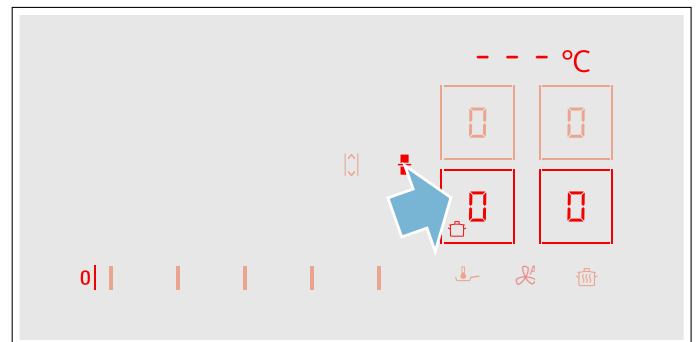

5. Select the right temperature setting from the table.

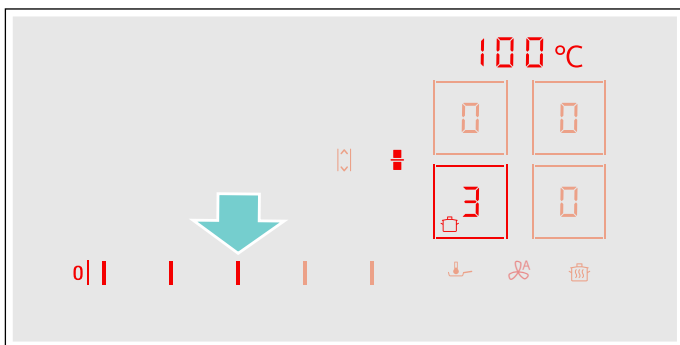

The function has now been activated.

The temperature symbol  will flash until the water or oil has reached the right temperature for adding the food. A signal will sound and the temperature symbol will stop flashing.

6. Once the signal has sounded, take the lid off and add the food. Keep the lid on during cooking.

Note: . Do not cover the pan when using the "Frying with a large amount of oil in the saucepan" function.

Switching off cooking functions

Select the hotplate and set it to  in the control panel. The hotplate will switch off and the residual heat indicator will appear.

Note: . To re-activate the cooking functions, wait for approximately 10 seconds.

Recommended dishes

The following table shows a selection of dishes and is arranged by food type. The temperature and the cooking time depend on the amount, the condition and the quality of the food.

Meat	Cooking assistance functions	Temperature setting	Total cooking time from signal tone (mins)
Function for frying with a small amount of oil			
Escalope, plain or breaded	Frying sensor	4	6 - 10
Fillet	Frying sensor	4	6 - 10
Chops*	Frying sensor	3	10 - 15
Cordon bleu, escalope*	Frying sensor	4	10 - 15
Steak, rare (3 cm thick)	Frying sensor	5	6 - 8
Steak, medium or well done (3 cm thick)	Frying sensor	4	8 - 12
Poultry breast (2 cm thick)*	Frying sensor	3	10 - 20
Sausages, pre-boiled or raw*	Frying sensor	3	8 - 20
Hamburgers, meatballs, stuffed meatballs*	Frying sensor	3	6 - 30
Meat loaf	Frying sensor	2	6 - 9
Strips of meat, gyros	Frying sensor	4	7 - 12
Minced meat	Frying sensor	4	6 - 10
Bacon	Frying sensor	2	5 - 8

* Turn several times.

** Heat the oil with the lid on. Fry in portions with the lid off (see table for cooking time per portion).

*** Add the food right at the beginning.

Meat	Cooking assistance functions	Temperature setting	Total cooking time from signal tone (mins)
Poaching function			
Sausages	Cooking functions	2 / 90 °C	10 - 20
Cooking function			
Meatballs	Cooking functions	3 / 100 °C	20 - 30
Chicken	Cooking functions	3 / 100 °C	60 - 90
Veal, boiled or stewed	Cooking functions	3 / 100 °C	60 - 90
Function for cooking in a pressure cooker			
Chicken, veal***	Cooking functions	4 / 120 °C	15 - 25
Function for frying with a large amount of oil			
Chicken portions and meatballs**	Cooking functions	5 / 170 °C	10 - 15
* Turn several times.			
** Heat the oil with the lid on. Fry in portions with the lid off (see table for cooking time per portion).			
*** Add the food right at the beginning.			

Fish	Cooking assistance functions	Temperature setting	Total cooking time from signal tone (mins)
Function for frying with a small amount of oil			
Frying a whole fish, e.g. trout	Frying sensor	3	10 - 20
Fish fillet, plain or breaded	Frying sensor	3 - 4	10 - 20
Prawns, scampi	Frying sensor	4	4 - 8
Poaching function			
Stewing fish, e.g. hake	Cooking functions	2 / 90 °C	15 - 20
Function for frying with a large amount of oil			
Fish, beer-battered or breaded*	Cooking functions	5 / 170 °C	10 - 15
* Heat the oil with the lid on. Fry in portions with the lid off (the table lists the cooking time per portion).			

Egg-based dishes	Cooking assistance functions	Temperature setting	Total cooking time from signal tone (mins)
Function for frying with a small amount of oil			
Pancakes*	Frying sensor	5	-
Omelette*	Frying sensor	2	3 - 6
Fried egg	Frying sensor	2 - 4	2 - 6
Scrambled egg	Frying sensor	2	4 - 9
Shredded raisin pancake	Frying sensor	3	10 - 15
French toast	Frying sensor	3	4 - 8
Cooking function			
Boiling eggs**	Cooking functions	3 / 100 °C	5 - 10
* Total cooking time per portion. Fry one after another.			
** Add the food right at the beginning.			

Vegetables and pulses	Cooking assistance functions	Temperature setting	Total cooking time from signal tone (mins)
Function for frying with a small amount of oil			
Garlic, onions	Frying sensor	1 - 2	2 - 10
Courgettes, aubergines	Frying sensor	3	4 - 12
Peppers, green asparagus	Frying sensor	3	4 - 15
Vegetables sautéed in oil, e.g. courgettes, green peppers	Frying sensor	1	10 - 20
Mushrooms	Frying sensor	4	10 - 15
Glazing vegetables	Frying sensor	3	6 - 10
Cooking function			
Fresh vegetables, e.g. broccoli	Cooking functions	3 / 100 °C	10 - 20
Fresh vegetables, e.g. Brussels sprouts	Cooking functions	3 / 100 °C	30 - 40
Chickpeas*	Cooking functions	3 / 100 °C	60 - 90
Peas	Cooking functions	3 / 100 °C	15 - 20
Lentil stew*	Cooking functions	3 / 100 °C	45 - 60
Function for cooking in a pressure cooker*			
Vegetables, e.g. green beans	Cooking functions	4 / 120 °C	3 - 6
Chickpeas, beans	Cooking functions	4 / 120 °C	25 - 35
Lentil stew	Cooking functions	4 / 120 °C	10 - 20
Function for frying with a large amount of oil			
Vegetables and mushrooms, breaded or beer-battered*	Cooking functions	5 / 170 °C	4 - 8
* Add the food right at the beginning.			
** Heat the oil with the lid on. Fry in portions with the lid off (see table for cooking time per portion).			

Potatoes	Cooking assistance functions	Temperature setting	Total cooking time from signal tone (mins)
Function for frying with a small amount of oil			
Fried potatoes (made from unpeeled boiled potatoes)	Frying sensor	5	6 - 12
Fried potatoes (made from raw potatoes)	Frying sensor	4	15 - 25
Potato fritter*	Frying sensor	5	2,5 - 3,5
Swiss rösti	Frying sensor	1	50 - 55
Glazed potatoes	Frying sensor	3	15 - 20
Poaching function			
Potato dumplings	Cooking functions	2 / 90 °C	30 - 40
Cooking function			
Potatoes**	Cooking functions	3 / 100 °C	30 - 45
Function for cooking in a pressure cooker			
Potatoes**	Cooking functions	4 / 120 °C	10 - 12
* Total cooking time per portion. Fry one after another.			
** Add the food right at the beginning.			

Pasta and cereals	Cooking assistance functions	Temperature setting	Total cooking time from signal tone (mins)
Poaching function			
Rice	Cooking functions	2 / 90 °C	25 - 35
Polenta*	Cooking functions	2 / 90 °C	3 - 8
Semolina pudding	Cooking functions	2 / 90 °C	5 - 10
Cooking function			
Pasta	Cooking functions	3 / 100 °C	7 - 10
Pastry parcels and filled dumplings	Cooking functions	3 / 100 °C	6 - 15
Function for cooking in a pressure cooker			
Rice**	Cooking functions	4 / 120 °C	5 - 8
* Heat up with the lid on; cook with the lid off and stir constantly.			
** Add the food right at the beginning.			

Soups	Cooking assistance functions	Temperature setting	Total cooking time from signal (mins)
Poaching function			
Instant soups, e.g. creamy soups	Cooking functions	2 / 90 °C	10 - 15
Cooking function			
Homemade broths, e.g. meat or vegetable soups**	Cooking functions	3 / 100 °C	60 - 90
Instant soups, e.g. minestrone	Cooking functions	3 / 100 °C	5 - 10
Cooking in a pressure cooker function			
Homemade broths, e.g. vegetable soups**	Cooking functions	4 / 120 °C	3 - 6
* Stir frequently.			
** Add the food straight away.			

Sauces	Cooking assistance functions	Temperature setting	Total cooking time from signal tone (mins)
Function for frying with a small amount of oil			
Tomato sauce with vegetables	Frying sensor	1	25 - 35
Béchamel sauce	Frying sensor	1	10 - 20
Cheese sauce, e.g. Gorgonzola sauce	Frying sensor	1	10 - 20
Reducing sauces, e.g. tomato sauce, Bolognese sauce	Frying sensor	1	25 - 35
Sweet sauces, e.g. orange sauce	Frying sensor	1	15 - 25

Desserts	Cooking assistance functions	Temperature setting	Total cooking time from signal tone (mins)
Poaching function			
Rice pudding*	Cooking functions	2 / 90 °C	40 - 50
Porridge	Cooking functions	2 / 90 °C	10 - 15
Compote**	Cooking functions	3 / 100 °C	15 - 25
Chocolate pudding***	Cooking functions	2 / 90 °C	3 - 5
* Stir regularly.			
** Add the food right at the beginning.			
*** Heat up with the lid on; cook with the lid off and stir constantly.			
**** Heat the oil with the lid on. Fry in portions with the lid off (the table lists the cooking time per portion).			

Desserts	Cooking assistance functions	Temperature setting	Total cooking time from signal tone (mins)
Function for frying with a large amount of oil			
Patisserie, e.g. ring or filled doughnuts****	Cooking functions	5 / 170 °C	5 - 10
* Stir regularly.			
** Add the food right at the beginning.			
*** Heat up with the lid on; cook with the lid off and stir constantly.			
**** Heat the oil with the lid on. Fry in portions with the lid off (the table lists the cooking time per portion).			

Frozen products	Cooking assistance functions	Temperature setting	Total cooking time from signal tone (mins)
Function for frying with a small amount of oil			
Escalope	Frying sensor	4	15 - 20
Cordon bleu*	Frying sensor	4	10 - 30
Poultry breast*	Frying sensor	4	10 - 30
Chicken nuggets	Frying sensor	4	10 - 15
Gyros, kebab	Frying sensor	3	5 - 10
Fish fillet, plain or breaded	Frying sensor	3	10 - 20
Fish fingers	Frying sensor	4	8 - 12
French fries	Frying sensor	5	4 - 6
Pan-fried dishes, e.g. fried vegetables with chicken	Frying sensor	3	6 - 10
Spring rolls	Frying sensor	4	10 - 30
Camembert/cheese	Frying sensor	3	10 - 15
Heating/keep-warm function			
Frozen vegetables in a creamy sauce, e.g. cream of spinach**	Cooking functions	1 / 70 °C	15 - 20
Cooking function			
Frozen vegetables, e.g. green beans**	Cooking functions	3 / 100 °C	15 - 30
Function for frying with a large amount of oil			
Frozen chips***	Cooking functions	5 / 170 °C	4 - 8
* Turn several times.			
** Add liquid according to the manufacturer's instructions.			
*** Heat the oil with the lid on. Fry in portions with the lid off (see table for cooking time per portion).			

Miscellaneous	Cooking assistance functions	Temperature setting	Total cooking time from signal tone (mins)
Function for frying with a small amount of oil			
Camembert/cheese	Frying sensor	3	7 - 10
Dried instant meals to which water is added, e.g. pasta dishes	Frying sensor	1	5 - 10
Croutons	Frying sensor	3	6 - 10
Almonds/hazelnuts/walnuts/pine nuts	Frying sensor	4	3 - 15
Heating/keep-warm function			
Food in jars and tins, e.g. goulash soup*	Cooking functions	1 / 70 °C	10 - 20
Mulled wine**	Cooking functions	1 / 70 °C	-
Poaching function			
Milk**	Cooking functions	2 / 90 °C	-
* Add the food right at the beginning and stir regularly.			
** Add the food right at the beginning.			

Preparing and maintaining the wireless temperature sensor

This section provides information on:

- Adhering the silicone patch
- Using the wireless cooking sensor
- Cleaning
- Changing the battery

The silicone patch and the cooking sensor can be purchased at a later time from specialist retailers, our technical after-sales service or our official website. To do this, quote the relevant reference number:

00577921	Set of 5 silicone patches
HZ39050	Cooking sensor and set of 5 silicone patches

Adhering the silicone patch

The silicone patch attaches the temperature sensor to the cookware.

When a pan is used for the first time with the cooking functions, the silicone patch must be adhered directly to the pan. It is important

1. that the adhesive area on the pan is free from grease. Clean the pan, dry it thoroughly and wipe the adhesive area with a spirit.
2. Remove the protective film from the silicone patch. Adhere the silicone patch to the outside of the pan in the correct place using the enclosed template as a guide.

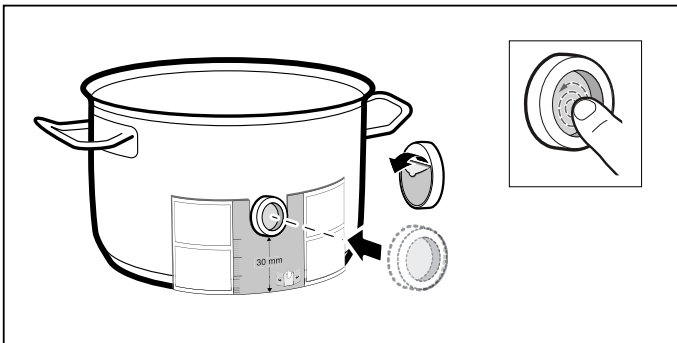

3. Press down all over the surface of the silicone patch, including in the centre.

The adhesive requires one hour to fully harden. Do not use or clean the pan during this time.

Notes

- Do not leave the pan with the silicone patch to soak soapy water for long periods of time.
- If the silicone patch comes off, attach a new one.

Fitting the wireless temperature sensor

Attach the temperature sensor to the silicone patch and align it correctly.

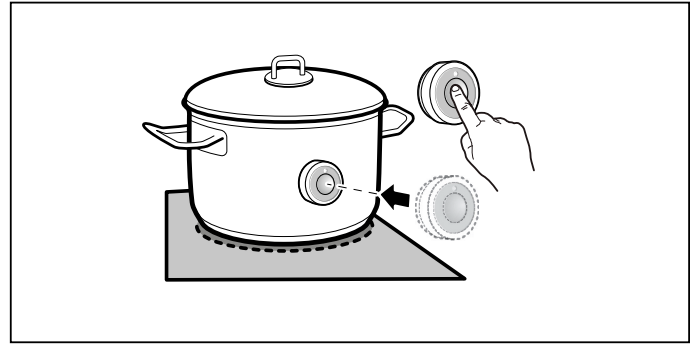

Notes

- Make sure that the silicone patch is completely dry before attaching the temperature sensor.
- Position the cookware in such a way that the temperature sensor is pointing towards the outer side of the hob.
- To prevent overheating, the temperature sensor must not be pointed towards another item of cookware that is hot.
- Remove the temperature sensor from the saucepan after cooking. Store it in a clean, safe place away from sources of heat.

Cleaning

Do not clean the wireless temperature sensor in the dishwasher.

You can find information on cleaning the temperature sensor in the section on → "Cleaning"

Changing the battery

If the temperature sensor does not light up when the symbol is pressed, the battery is flat.

Changing the battery:

1. Remove the silicone cover from the lower section of the temperature sensor housing and remove both screws using a screwdriver.

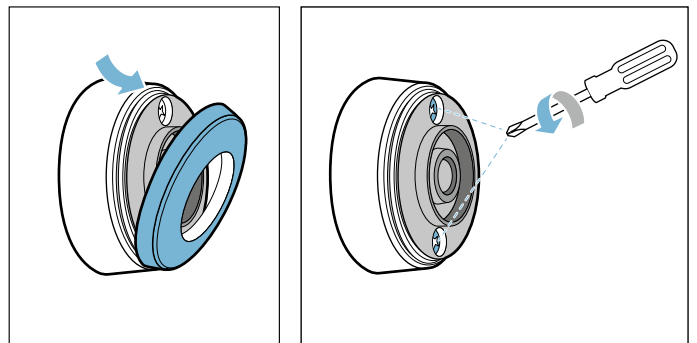

2. Open the closure of the temperature sensor. Remove the battery from the lower section of the housing and insert a new battery (pay attention to the correct orientation of the battery poles).

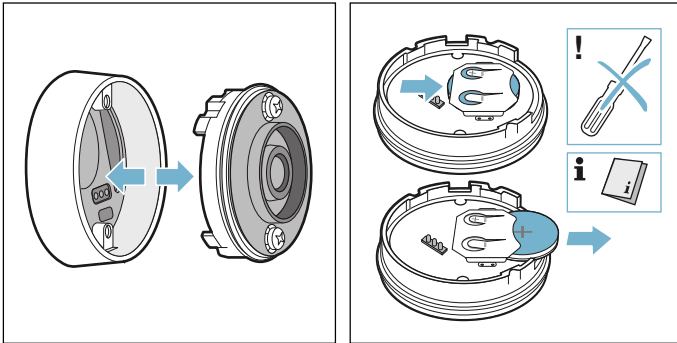

Caution!

Do not use any metal objects to remove the battery. Do not touch the battery connection points.

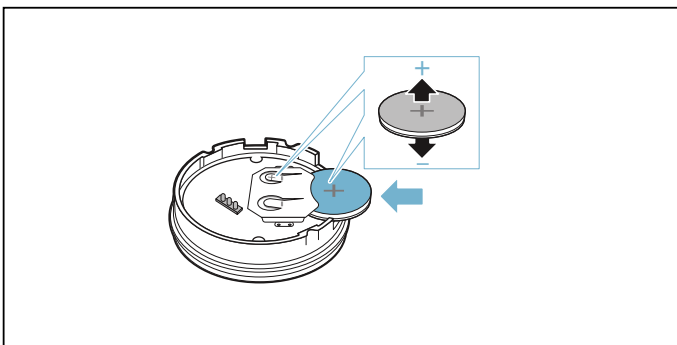

3. Close the closure of the temperature sensor (the notches for the screws on the closure must align with the notches on the lower section of the housing). Tighten the screws with a screwdriver.

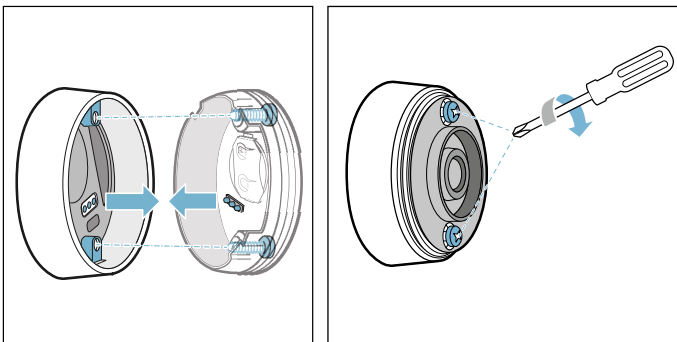

4. Reattach the silicone cover to the lower section of the temperature sensor housing.

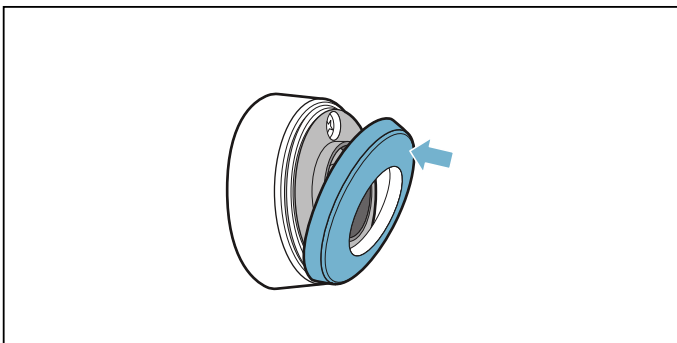

Note: Use only high-quality batteries of the type CR2032 in order to guarantee a long service life.

Declaration of Conformity

BSH Hausgeräte GmbH hereby declares that the appliance with wireless temperature sensor function meets the basic requirements and other relevant provisions of the Directive 2014/53/EU.

A detailed RED Declaration of Conformity can be found online at www.siemens-home.bsh-group.com on the product page of your appliance with the additional documents.

The logos and the Bluetooth® brand are registered trademarks and property of Bluetooth SIG, Inc. These trademarks are used by BSH Hausgeräte GmbH under licence. All other trademarks and brand names are owned by the respective companies.



Childproof lock

You can use the childproof lock to prevent children from switching on the hob.

Activating and deactivating the childproof lock

The hob must be off.

To activate:

1. Switch on the hob using the main switch.
2. Touch and hold the  symbol for approx. 4 seconds.
The  indicator lights up for 10 seconds.
The hob is locked.

To deactivate:

1. Switch on the hob using the main switch.
2. Touch and hold the  symbol for approx. 4 seconds.
The lock is released.

Childproof lock

With this function, the childproof lock automatically activates when a hob is switched off.

Switching on and off

You can find out how to switch the automatic childproof lock on in the → *"Basic settings"* section

Wipe protection

If you wipe over the control panel while the hob is switched on, settings may be altered. To avoid doing this, you can use the hob's "Lock control panel for cleaning" function.

To activate: Touch the  symbol. An audible signal sounds. The control panel is locked for 35 seconds. You can now wipe over the surface of the control panel without altering any settings.

To deactivate: The control panel will be unlocked once 35 seconds have elapsed. To release the function early, touch the  symbol.

Notes

- An audible signal sounds 30 seconds after activation. This indicates that the function is about to finish.
- The cleaning lock does not lock the main switch. The hob can be switched off at any time.

Automatic safety cut-out

If a hotplate operates for an extended period and no settings are changed, the automatic safety shut-off is activated.

The hotplate stops heating. **F**, **B** and the residual heat indicator **h** or **H** flash alternately in the hotplate display.

When you touch any symbol, the display switches off. The hotplate can now be set again.

The point at which the safety shut-off becomes active depends on which heat setting has been set (after 1 to 10 hours).

Basic settings

The appliance has various basic settings. You can adapt these to suit your cooking habits.

Indicator/ symbol	Function
c 1	Automatic childproof lock 0 Manual*. 1 Automatic. 2 Function deactivated.
c 2	Audible signals 0 Confirmation and fault signals are switched off. 1 Only the fault signal is switched on. 2 Only the confirmation signal is switched on. 3 All signal tones are switched on.*
c 3	Display energy consumption 0 Switched off.* 1 Switched on.
c 4	Setting to account for height above sea level 1-2 Decrease 3 Basic setting 4-9 Increase
c 5	Automatically programming the cooking time 00 Switched off.* 0 1-99 Time until automatic switch-off.
c 6	Duration of the timer end signal tone 1 10 seconds.* 2 30 seconds. 3 1 minute.
c 7	Power management function. Limiting the total power of the hob 0 Switched off.* 1 1000 W minimum power. 1-5 1500 W 2 2000 W. ... 9 or 9. Maximum power of the hob.
c 11	Changing the preset heat settings for the Move function -9 Preset heat setting for the front cooking zone. -5 Preset heat setting for the central cooking zone. -1-5 Preset heat setting for the rear cooking zone.
c 12	Checking cookware; cooking results 0 Not suitable 1 Not perfect 2 Suitable

* Factory settings

Indicator/ symbol	Function
c 13	Configuring activation of the flexible cooking zone 0 As two independent hotplates. 1 As a single hotplate.*
c 14	Connecting the wireless temperature sensor to the hob 0 Connected correctly 1 Not connected correctly: Transmission error. 2 Not connected correctly: Temperature sensor fault.
c 17	Setting air recirculation mode or air extraction mode 0 Air recirculation mode has been set.* 1 Air extraction mode has been set.
c 18	Setting automatic start 0 Switched off. 1 Switched on: Automatic mode with sensor control* 2 Switched on: The ventilation system starts at a fixed fan setting.
c 19	Setting the sensor sensitivity for the ventilation system 1 Lowest sensor sensitivity setting. 2 Medium sensor sensitivity setting.* 3 Highest sensor sensitivity setting.
c 20	Setting the run-on 0 Switched off. 1 Switched on: Automatic function with sensor-controlled run-on. 2 Switched on: The ventilation system runs in air extraction mode for approx. 6 minutes and in air recirculation mode for approx. 30 minutes at fan setting 1 and automatically switches off once this time has elapsed.*
c 0	Restoring the factory settings 0 Individual settings.* 1 Restoring the factory settings.

* Factory settings

To access the basic settings:

The hob must be off.

1. Switch on the hob.
2. Within ten seconds, touch and hold the ⊖ symbol for approximately four seconds.
The first four displays provide product information.
Touch the settings area to view the individual displays.

Product information	Display screen
After-sales service index (ASSI)	01
Production number	Fd
Production number 1	95.
Production number 2	05

3. Touching the ⊖ symbol again takes you to the basic settings.
c 1 and 0 light up as a presetting in the displays.



4. Touch the ⊖ symbol repeatedly until the required function is displayed.

5. Then select the required setting from the settings area.

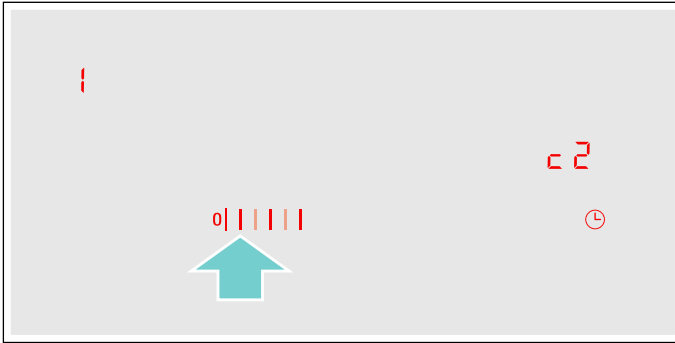

6. Touch the ⌚ symbol for at least four seconds.

The settings have been saved.

Leaving the basic settings

Turn off the hob with the main switch.

Energy consumption indicator

This function indicates the total amount of energy consumed by this hob the last time it was used for cooking.

Once switched off, the energy consumption in kWh is displayed for 10 seconds.

The picture shows an example with an energy consumption of **1.08** kWh.

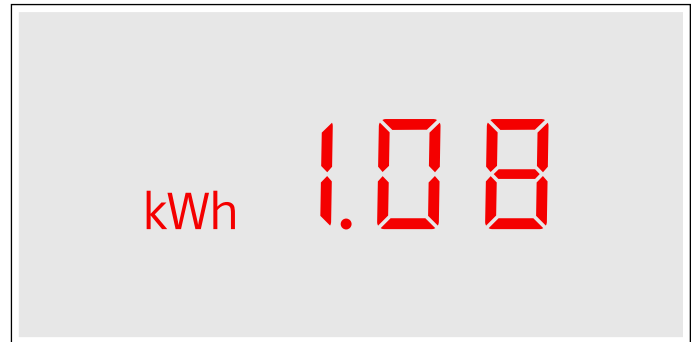

You can find out how to switch this function on in the section on → *"Basic settings"*

Cookware check

This function can be used to check the speed and quality of the cooking process depending on the cookware.

The result is a reference value and depends on the properties of the cookware and the hotplate being used.



1. With the cookware still cold, fill it with approx. 200 ml of water and place it on the centre of the hotplate with the diameter that most closely matches that of the base of the cookware.
2. Go to the basic settings and select the **c 12** setting.
3. Touch the settings range. **—** will flash on the hotplate display.

The function has now been activated.

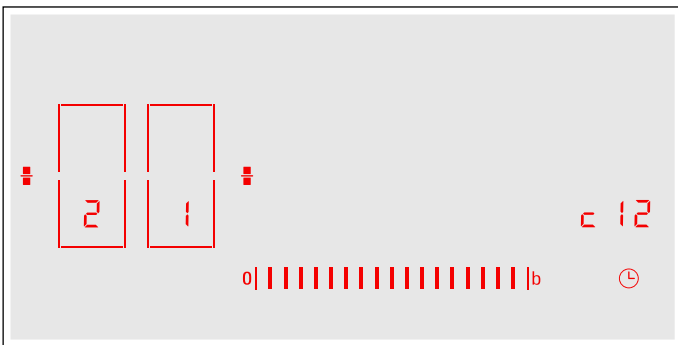
After 10 seconds, the result for the quality and speed of the cooking process will appear on the hotplate display.



Check the result using the following table:

Result	
	The cookware is not suitable for the hotplate and will therefore not heat up.*
	The cookware is taking longer to heat up than expected and the cooking process is not going as well as it should.*
	The cookware is heating up correctly and the cooking process is going well.
* If there is a smaller hotplate available, test the cookware again on the smaller hotplate.	

To reactivate this function, touch the settings range.

Notes

- The flexible cooking zone only counts as a single hotplate; place no more than one item of cookware on it.
- If the diameter of the hotplate used is much smaller than the diameter of the cookware, only the middle of the cookware can be expected to heat up. This may result in the cooking results not being as good as expected or being less than satisfactory.
- You can find information on this function in the section on → *"Basic settings"*.
- You can find information on the type, size and positioning of the cookware in the sections on → *"Induction cooking"* and → *"Flex Zone"*.

Cleaning

Warning – Risk of burns!

The appliance becomes hot during operation. Allow the appliance to cool down before cleaning.

Warning – Risk of burns!

The appliance will become hot during operation. If hot liquids penetrate the appliance, leave the appliance to cool for at least two hours before removing the filter cover, the metal grease filter, the container, the overflow reservoir or the appliance housing.

Warning – Risk of electric shock!

Do not use any high-pressure cleaners or steam cleaners, which can result in an electric shock.

Warning – Risk of electric shock!

Penetrating moisture may result in an electric shock. Clean the appliance using a damp cloth only. Before cleaning, pull out the mains plug or switch off the circuit breaker in the fuse box.

Warning – Risk of injury!

Components inside the appliance may have sharp edges. Wear protective gloves.

Note: Only use a minimal amount of water when cleaning so that no water enters the appliance.

Notes

- Before cleaning the appliance, remove any jewellery you are wearing on your arms and hands.
- Do not use any cleaning agents while the hob is still hot. This may mark the surface. Ensure that any residue left by cleaning agents is removed.

Cleaning agents

Only use cleaning products that are suitable for this type of hob. Follow the manufacturer's instructions on the product packaging.

Follow all instructions and warnings included with the cleaning products.

Suitable maintenance and cleaning products can be purchased from the after-sales service or in our e-Shop.

Caution!

Beware of causing surface damage

Do not use:

- Undiluted washing-up liquid
- Cleaning products designed for dishwashers
- Abrasive cleaning products
- Pressure washers or steam jet cleaners
- Oven cleaners
- Corrosive or aggressive cleaners, or those containing chlorine
- Cleaners containing a large percentage of alcohol
- Hard, scratchy sponges, brushes or scouring pads

Caution!

Beware of causing surface damage

Always wash new sponge cloths thoroughly before use.

To ensure that the different surfaces are not damaged by using the wrong cleaning product, follow the instructions in the table.

Area	Cleaning product
Glass ceramic	<p>Glass cleaner for stains caused by limescale and residual water: Clean the hob as soon as it has cooled down. You can use a cleaning product that is suitable for glass-ceramic hobs or glass cleaner (article no. 00311499).</p> <p>Glass scraper (article no. 00087670) for stains caused by sugar, rice starch or plastic: Clean immediately. Caution: Risk of burns. Then clean with a damp dish cloth and then dry with a cloth or towel.</p> <p>Note: Do not use cleaning products designed for dishwashers.</p>
Stainless steel	<p>Hot soapy water: Clean with a dish cloth and then dry with a soft cloth.</p> <p>Use a minimal amount of water when cleaning to prevent water from penetrating the appliance.</p> <p>Leave dried-on remnants to soak in a small amount of soapy water; do not scour.</p> <p>Always clean stainless steel surfaces in the direction of the grain.</p> <p>Special stainless steel cleaning products (article no. 00311499) are available from our after-sales service, through our online shop or from specialist retailers. Apply a very thin layer of the cleaning product with a soft cloth.</p> <p>Note: Do not use a glass scraper to clean the hob surround.</p>
Plastic	<p>Hot soapy water: Clean with a soft cloth or in the dishwasher.</p>
Controls	<p>Hot soapy water or an appropriate glass cleaner (article no. 00311499): Clean using a damp dish cloth and then dry with a soft cloth.</p>
Filter cover	<p>Hot soapy water: Clean using a damp dish cloth and then dry with a soft cloth.</p>

Components to clean

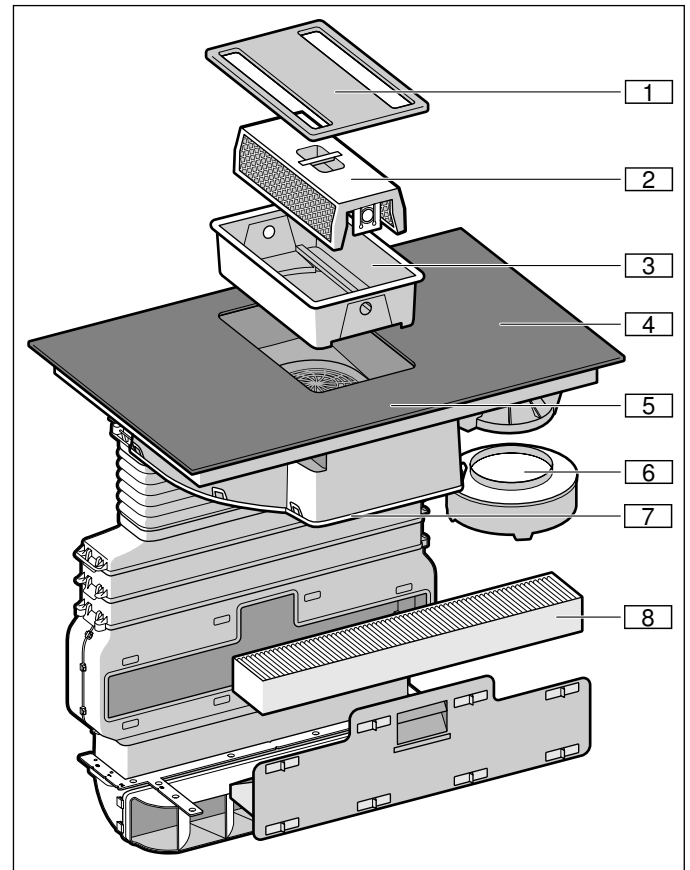

No.	Name
1	Filter cover
2	Metal grease filter
3	Container
4	Hob
5	Control panel
6	Overflow container
7	Housing cover
8	Activated charcoal filter (only in air recirculation mode)

Hob surround (only on appliances with hob surrounds)

To prevent damage to the hob surround, observe the following instructions:

- Only use warm soapy water
- Wash new dish cloths thoroughly before use.
- Do not use harsh or abrasive cleaning agents.
- Do not use a glass scraper or sharp objects.

Hob

Clean the hob each time you use it. This will prevent food remnants from becoming burned on. Do not clean the hob until the residual heat indicator has gone out. Remove boiled-over liquids immediately and do not allow any food remains to dry on.

Clean the hob with a damp dish cloth and dry it with a cloth or towel to prevent limescale build-up.

Stubborn dirt is best removed with a glass scraper or glass ceramic cleaner (available from retailers). Follow the manufacturer's instructions.

You can obtain a suitable glass scraper (article no. 00087670) from our after-sales service or through our online shop.

Using a special sponge for cleaning glass-ceramic hobs achieves great cleaning results.

Ventilation system

The filter must be regularly cleaned or replaced in order to guarantee efficient filtration of odours and grease.

Metal grease filter

The metal grease filters should be cleaned every 30 operating hours or at least once a month.

Warning – Risk of fire!

Grease deposits in the grease filter may catch fire.

Clean the grease filter at least once a month.

Never operate the appliance without the grease filter.

Activated charcoal filters

The activated charcoal filter should be replaced regularly. The saturation indicator on your appliance will tell you how frequently this needs to be done.

Saturation display

If the metal grease filter or activated charcoal filter becomes saturated, a signal will sound once the appliance has been switched off.



The following symbols will light up in the display panel:

- **Metal grease filter:** *F 10* lights up
- **Activated charcoal filter:** *F 11* lights up
- **Metal grease filter and activated charcoal filter:** *F 10* and *F 11* light up alternately

Do not wait any longer to clean the metal grease filter or replace the activated charcoal filter.

Once you have cleaned or replaced the relevant filters, reset the saturation indicator so that the *F 10* and *F 11* indicators go out.

After the appliance has been switched off, *F 10* or *F 11* lights up.

1. Touch the  symbol.
A signal tone will sound. The metal grease filter saturation indicator has now been reset.
2. If *F 11* lights up, touch the  symbol again.
A signal tone will sound. The activated charcoal filter saturation indicator has now been reset.

Changing the activated charcoal filter (only in circulating-air mode)

Activated charcoal filters trap the odour-causing compounds in cooking smells. They are only used for circulating-air mode.

Notes

- The activated charcoal filter is not included with the appliance. The activated charcoal filter (article no. HZ381700) is available from specialist retailers, from our after-sales service or from our online shop.
- The activated charcoal filter cannot be cleaned or reactivated.
- Only use genuine replacement filters. This will ensure that the appliance performs optimally.

1. Unlock all of the closing elements on the drawer in the flat duct of the fitted unit.

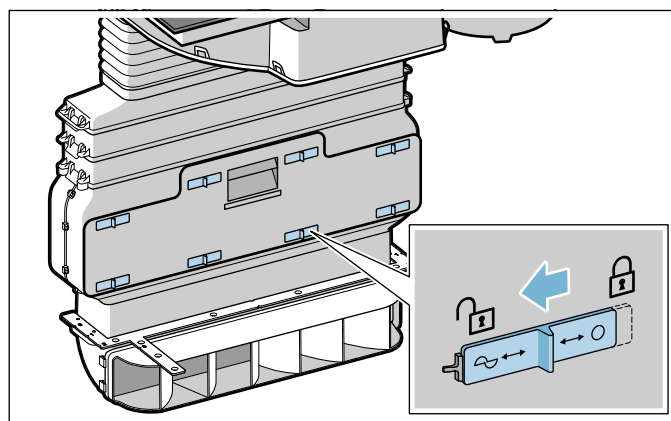

2. Open the drawer in the flat duct and remove the activated charcoal filter.

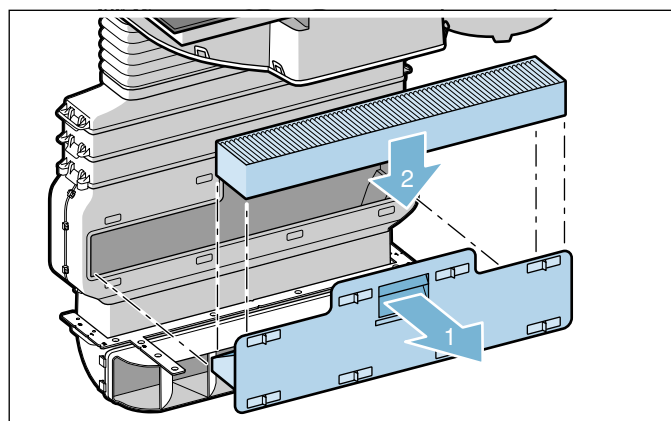

3. Insert the new activated charcoal filter.
4. Close the drawer in the flat duct and lock all of the closing elements.

Note: Make sure that all of the closing elements have been locked correctly. Otherwise noises may be generated and the power of the ventilation system may be reduced.

Removing metal grease filter

The metal grease filters filter the grease out of kitchen steam. To keep them in good working order, the filters should be cleaned at least once a month.

1. Take the filter cover off.

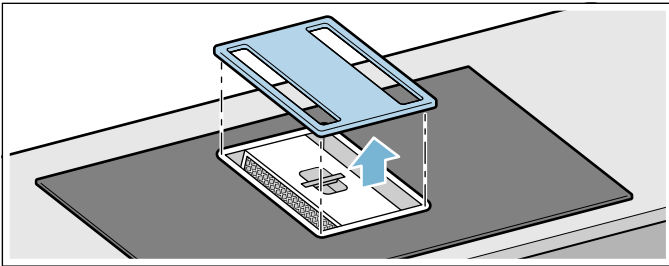

Note: Make sure that the filter cover does not fall and damage the hob.

2. Take the metal grease filter and the container out.

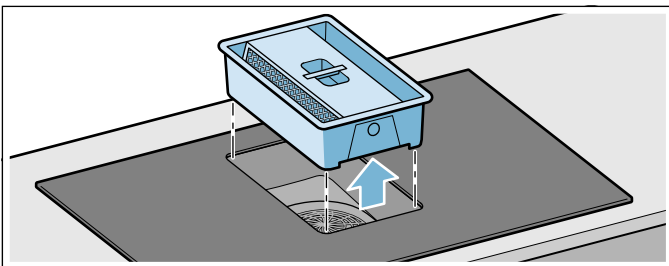

Note: Fat may accumulate in the bottom of the container. Hold the metal grease filter level to prevent fat from dripping out.

3. Press down on the two catches on either side of the container to separate the metal grease filter from the container.

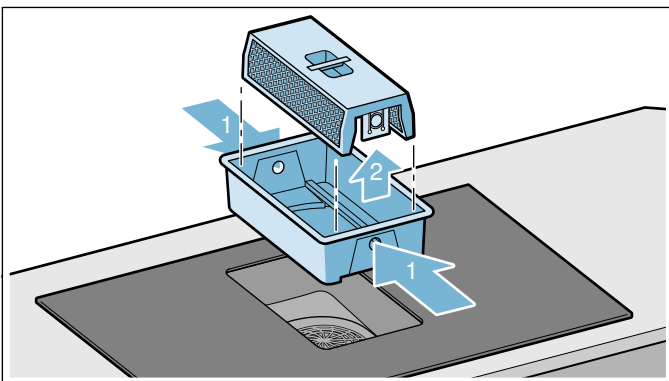

4. Empty the container if necessary.
5. Clean the metal grease filter and filter cover.
6. After removing the metal grease filter, clean the inside of the appliance.

Note: Droplets of water may form on the fan wheel. This is normal and occurs as a result of the cooking vapours condensing. It is not a safety hazard and there is no risk of damage. The electronic components in the appliance are protected.

Cleaning the metal mesh grease filters

Notes

- Do not use aggressive, acidic or alkaline cleaning products.
- The metal grease filter can be cleaned in the dishwasher or by hand.

By hand:

Note: You can use a special degreaser to remove stubborn dirt (article no. 00311297). This can be ordered through our online shop.

- Soak the metal grease filter in hot soapy water.
- Clean the metal grease filter with a brush and then rinse it thoroughly.
- Leave the metal grease filter to drain.

In the dishwasher:

- Do not clean the metal grease filter together with cookware if heavily soiled.
- Place the metal grease filter in the dishwasher, leaving plenty of space around it. Do not trap the metal grease filter.
- For best results, place the metal grease filter in the dishwasher filter side down.

Fitting and cleaning other appliance components

Also clean the inside of the hob extractor system regularly. You can use a special degreaser to remove stubborn dirt (article no. 00311297).

1. Remove the filter cover and clean it with a damp cloth.

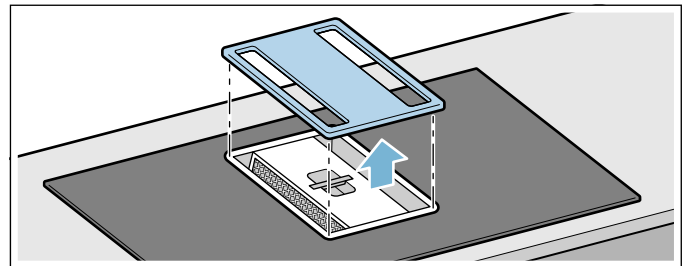

2. Remove the metal grease filter and container.

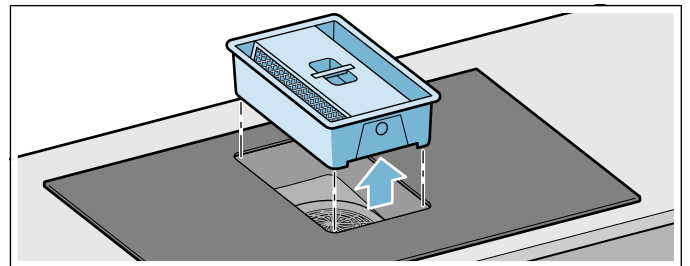

3. Press down on the two catches on either side of the container to separate the metal grease filter from the container.

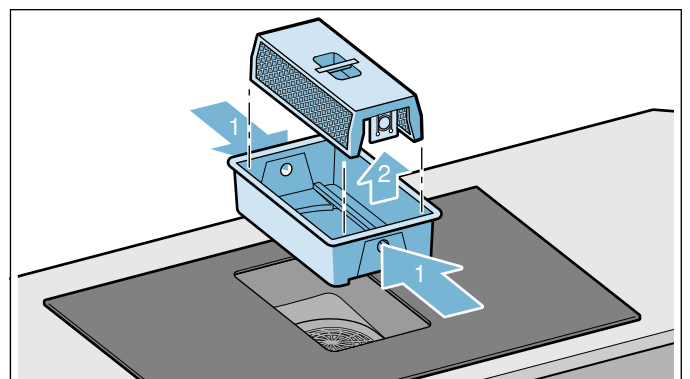

4. Empty the container if necessary.

- Clean the metal grease filter and the container in the dishwasher.
- If required, take off the housing cover underneath the appliance and clean it.

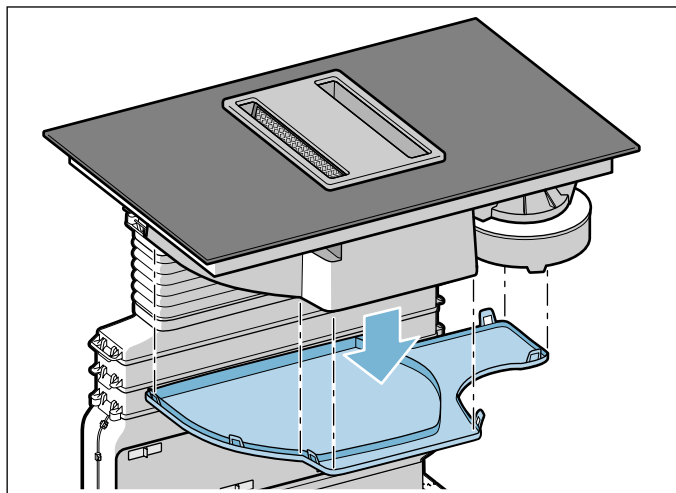

- Clean the parts and dry them before refitting them.

Inserting the metal grease filters



- Insert the container.
- Insert the metal grease filter.

Note: Ensure that the metal grease filter has been inserted correctly. Otherwise, the ventilation system does not work.
- Put the filter cover on.

Resetting the saturation displays

Once you have cleaned or replaced the relevant filters, reset the saturation indicator so that the **F 10** and **F 11** indicators go out.

After the appliance has been switched off, **F 10** or **F 11** lights up.

- Touch the  symbol.
A signal tone will sound. The metal grease filter saturation indicator has now been reset.
- If **F 11** lights up, touch the  symbol again.
A signal tone will sound. The activated charcoal filter saturation indicator has now been reset.

Cleaning the overflow container

Notes

- Make sure that the supply to the overflow container is not blocked. Remove any objects that have entered the appliance once it has cooled down. To do this, take the filter cover off and take the metal grease filter and the container out.
- Any liquid entering the appliance from above will be collected in the overflow container. Unscrew the overflow container and empty it. Take the housing cover off if necessary.

- Unscrew the overflow container with both hands.

Notes

- Hold the overflow container level to prevent liquid from leaking out.
- If the metal grease filter and the container have been removed and liquid finds its way into the appliance through the fan grille, you will need to remove the housing cover.

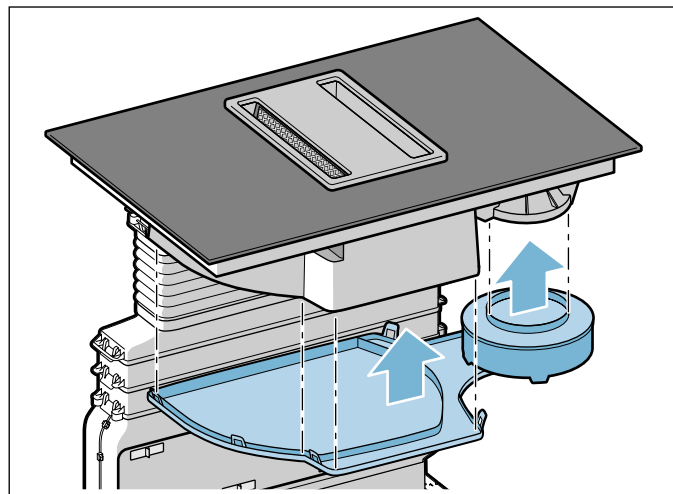

- Empty the overflow container, as well as the housing cover if necessary, and rinse it/them out.
- Clean the overflow container before screwing it back into place.
- Refit the housing cover.

Wireless temperature sensor

Temperature sensor

Clean the temperature sensor with a damp cloth. Never clean it in the dishwasher. Do not immerse it in water or clean it under running water.

Remove the temperature sensor from the saucepan after cooking. Store it in a clean, safe place (such as in its packaging) away from sources of heat.

Silicone patch

Clean and dry before attaching to the temperature sensor. Dishwasher safe.

Note: Cookware with the silicone patch must not be left to soak for long periods in soapy water.

Temperature sensor window

The sensor window must always be clean and dry. Proceed as follows:

- Remove dirt and oil splatters regularly.
- Use a soft cloth or cotton buds and window cleaner for cleaning.

Notes

- Do not use abrasive cleaning agents such as scouring pads, scrubbing brushes or cream cleaners.
- Do not touch the sensor window with your fingers. This may make it dirty or scratch it.

Frequently Asked Questions (FAQ)

Using the appliance

Why can't I switch on the hob and why is the childproof lock symbol lit?

The childproof lock is activated.

You can find information on this function in the section on → *"Childproof lock"*

Why are the displays flashing and why can I hear an audible signal?

Remove any liquid or food remains from the control panel. Remove any objects from the control panel.

You can find instructions on how to deactivate the audible signal in the section on → *"Basic settings"*

Noises

Why I can hear noises while I'm cooking?

Noises may be generated while using the hob depending on the base material of the cookware. These noises are a normal part of induction technology. They do not indicate a defect.

Possible noises:

A low humming noise like the one a transformer makes:

Occurs when cooking at a high heat setting. The noise disappears or becomes quieter when the heat setting is reduced.

Low whistling noise:

Occurs when the cookware is empty. This noise disappears when water or food is added to the cookware.

Crackling:

Occurs when using cookware made from different layers of material or when using cookware of different sizes and different materials at the same time. The loudness of the noise can vary depending on the quantity of food being cooked or the cooking method.

High-pitched whistling noises:

Can occur when two hotplates are used at the highest heat setting at the same time. The whistling noises disappear or become quieter when the heat setting is reduced.

Fan noise:

The hob is equipped with a fan that switches on automatically at high temperatures. The fan may continue to run even after you have switched off the hob if the temperature detected is still too high.

Cookware

Which types of cookware can be used with an induction hob?

You can find information on which types of cookware can be used with an induction hob in the section on → *"Induction cooking"*.

Why is the hotplate not heating up and why is the heat setting flashing?

The hotplate on which the cookware is standing is not switched on.

Check that you have switched on the correct hotplate.

The cookware is too small for the hotplate that is switched on or it is not suitable for induction cooking.

Check that the cookware is suitable for induction cooking and that it is placed on the hotplate that best corresponds to its size. You can find information on the type, size and positioning of cookware in the sections on → *"Induction cooking"*, → *"Flex Zone"* and → *"Move function"*.

Why is it taking so long for the cookware to heat up or why is it not heating up sufficiently despite being on a high heat setting?

The cookware is too small for the hotplate that is switched on or it is not suitable for induction cooking.

Check that the cookware is suitable for induction cooking and that it is placed on the hotplate that best corresponds to its size. You can find information on the type, size and positioning of cookware in the sections on → *"Induction cooking"*, → *"Flex Zone"* and → *"Move function"*.

Cleaning**How do I clean the hob?**

Using a special glass-ceramic cleaning agent produces the best results. We advise against using harsh or abrasive cleaning agents, dishwasher detergent (concentrated) or scouring pads.

You can find more information on cleaning and caring for your hob in the section on → *"Cleaning"*

Trouble shooting

Usually, faults are small matters that are easy to eliminate. Please read the information in the table before calling the after-sales service.

Warning – Risk of electric shock!

Incorrect repairs are dangerous. Repairs may only be carried out and damaged power cables replaced by one of our trained after-sales technicians. If the appliance is defective, unplug the appliance from the mains or switch off the circuit breaker in the fuse box. Contact the after-sales service.

Fault/display	Possible cause	Solution
The appliance does not work	The plug is not plugged into the mains	Connect the appliance to the electricity supply
	Power cut	Check whether other kitchen appliances are working
	The circuit breaker is faulty	Check in the fuse box to make sure that the fuse for the appliance is OK
The symbol lighting is not working.	The control unit is faulty.	Call our after-sales service.
The ventilation system is not working.	The metal grease filter has not been inserted correctly.	Insert the metal grease filter correctly. → "Cleaning" on page 39
	The filter detection sensor is not working.	Call the after-sales service.
F 10	The metal grease filter is saturated.	Clean the metal grease filter. → "Cleaning" on page 39
F 11	The activated charcoal filter is saturated.	Replace the activated charcoal filter. → "Cleaning" on page 39
F 10 / F 11	The saturation indicator is lit even though the filter has been cleaned or replaced.	Reset the saturation indicator. → "Resetting the saturation displays" on page 43
Nothing on the display	The power supply has been disconnected.	Use other electrical appliances to check whether a short circuit has occurred in the power supply.
	The appliance has not been connected as shown in the circuit diagram.	Check that the appliance has been connected as shown in the circuit diagram.
	Electronics fault.	If the fault cannot be rectified, inform the technical after-sales service.
The indicators/symbols are flashing	The control panel is wet or an object is covering it.	Dry the control panel or remove the object.
F 2	The electronics have overheated and switched off the affected hotplate.	Wait until the electronics have cooled down sufficiently. Then touch any symbol on the hob.
F 4	The electronics have overheated and all the hotplates have been switched off.	
F 5 + heat setting and signal tone	There is a hot pan near the control panel. There is a risk that the electronics will overheat.	Remove the pan. The fault code will go out shortly afterwards. You can resume cooking.
F 5 and signal tone	There is a hot pan near the control panel. To protect the electronics, the hotplate has been switched off.	Remove the pan. Wait a few seconds. Touch any touch control. When the fault code on the display goes out, you can resume cooking.
F 1 / F 6	The hotplate has overheated and has been switched off to protect the work surface.	Wait until the electronics have cooled down sufficiently before switching the hotplate on again.
F 0	The transfer settings function cannot be activated	Touch any touch control to check the fault code. You can cook as usual without using the transfer settings function. Contact the technical after-sales service.
F 9	The FlexPlus cooking zone cannot be activated	Touch any touch control to check the fault code. You can use the remaining hotplates to cook as usual. Contact the technical after-sales service.
F 8	The hotplate has been operating continuously for an extended period.	The automatic safety switch-off function has been activated. See the section entitled
E 8 2 0 2	The temperature sensor has overheated and the hotplate has been switched off.	Wait until the temperature sensor has cooled down sufficiently before activating the function again.
E 8 2 0 3	The temperature sensor has overheated and all the hotplates have been switched off.	If you are not using the temperature sensor, remove it from the cookware and keep it away from the other hotplates and sources of heat. Switch the hotplates back on.
E 8 2 0 4	The battery in the temperature sensor is flat.	Replace the 3 V CR2032 battery. See the section entitled → "Changing the battery"

Do not place hot pans on the control panel.

E8205	The temperature sensor is disconnected.	Switch the function off and then on again.
E8206	The temperature sensor is broken/faulty.	Contact the technical after-sales service.
The temperature sensor indicator is not lighting up	The temperature sensor is not responding and the indicator is not lighting up.	Replace the 3 V CR2032 battery. See the section entitled → "Changing the battery" If this does not solve the problem, press and hold the temperature sensor button for 8 minutes, and then reconnect the temperature sensor to the hob. If the problem persists, contact the technical after-sales service.
The indicator on the temperature sensor flashes twice.	The battery in the temperature sensor has almost run out. You may be interrupted the next time you cook by the battery running out.	Replace the 3 V CR2032 battery. See the section entitled → "Changing the battery"
The indicator on the temperature sensor flashes three times.	The temperature sensor is disconnected.	Press and hold the symbol on the temperature sensor for 8 seconds and then reconnect the temperature sensor to the hob.
E9000 E90 10	The operating voltage is incorrect/outside of the normal operating range.	Contact your electricity supplier.
U400	The hob is not connected properly	Disconnect the hob from the power supply. Check that it has been connected as shown in the circuit diagram.
dE	Demo mode is activated	Disconnect the hob from the power supply. Wait for 30 seconds before reconnecting it. Touch any touch control in the next 3 minutes. This will deactivate demo mode.

Do not place hot pans on the control panel.

Notes

- If **E** appears on the display, press and hold the button for the relevant cooking zone in order to read the fault code.
- If the fault code is not listed in the table, disconnect the hob from the mains power supply and wait 30 seconds before reconnecting it. If this code is displayed again, contact the technical after-sales service and specify which fault code has appeared.
- If a fault occurs, the appliance will not switch to standby mode.

Customer service

Our after-sales service is there for you if your appliance needs to be repaired. We will always find an appropriate solution, also in order to avoid after-sales personnel having to make unnecessary visits.

E number and FD number

Please quote the E-number (product number) and the FD number (production number) of your appliance when contacting our after-sales service.

The rating plate bearing these numbers can be found:

- On the appliance certificate.
- On the underside of the hob.

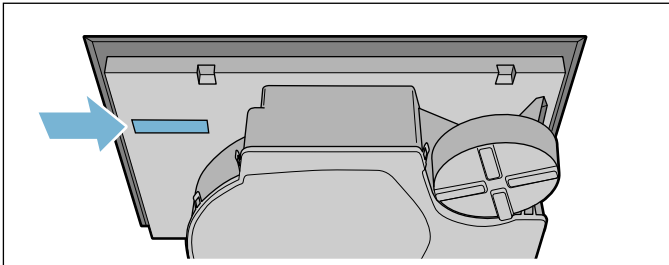
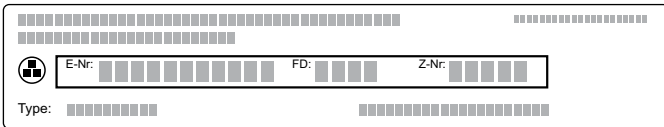

The E number can also be found on the hob's glass ceramic surface. You can check the after-sales service index (KI) and FD number by going to the basic settings. Refer to the section entitled → "*Basic settings*" to find out how to do this.

Please note that a visit from an after-sales service engineer is not free of charge in the event that the appliance has been misused, even during the warranty period.

Please find the contact data of all countries in the enclosed customer service list.

To book an engineer visit and product advice

GB 0344 892 8999

Calls charged at local or mobile rate.

IE 01450 2655

0.03 € per minute at peak. Off peak 0.0088 € per minute.

Rely on the professionalism of the manufacturer. You can therefore be sure that the repair is carried out by trained service technicians who carry original spare parts for your appliances.

Test dishes

This table has been produced for test institutes to facilitate the testing of our appliances.

The data in the table refers to our Schulte-Ufer cookware accessories (4 piece cookware set for the HZ 390042 induction hob) with the following measurements:

- Saucepan Ø 16 cm, 1.2 l for hotplates of Ø 14.5 cm
- Pot Ø 16 cm, 1.7 l for hotplates of Ø 14.5 cm
- Pot Ø 22 cm, 4.2 l for hotplates of Ø 18 cm
- Frying pan Ø 24 cm, for hotplates of Ø 18 cm

Test dishes	Cookware	Heat setting	Preheating		Cooking	
			Cooking time (min:sec)	Lid	Heat setting	Lid
Melting chocolate						
Chocolate coating (e.g. Dr. Oetker brand, dark chocolate 55% cocoa, 150 g)	Saucepan, 16 cm diameter	-	-	-	1.5	No
Heating and keeping lentil stew warm						
Lentil stew*						
Initial temperature 20 °C						
Amount: 450 g	Cooking pot, 16 cm diameter	9	1:30 (without stirring)	Yes	1.5	Yes
Amount: 800 g	Saucepan, 22 cm diameter	9	2:30 (without stirring)	Yes	1.5	Yes
Lentil stew from a tin						
E.g lentils with Erasco sausages.						
Initial temperature 20 °C						
Amount: 500 g	Cooking pot, 16 cm diameter	9	Approx. 1:30 (stir after approx. 1 minute)	Yes	1.5	Yes
Amount: 1 kg	Saucepan, 22 cm diameter	9	Approx. 2:30 (stir after approx. 1 minute)	Yes	1.5	Yes
Preparing Béchamel sauce						
Temperature of the milk: 7 °C						
Ingredients: 40 g butter, 40 g flour, 0.5 l milk (3.5% fat content) and a pinch of salt						
1. Melt the butter, stir in the flour and salt, and heat up the mixture.	Saucepan, 16 cm diameter	2	Approx. 6:00	No	-	-
2 Add the milk to the roux and bring to the boil, stirring continuously.		7	Approx. 6:30	No	-	-
3. Once the Béchamel sauce comes to the boil, leave it on the hotplate for a further two minutes, stirring continuously.		-	-	-	2	No
*Recipe in accordance with DIN 44550						
**Recipe in accordance with DIN EN 60350-2						

Test dishes	Cookware	Heat setting	Preheating		Cooking	
			Cooking time (min:sec)	Lid	Heat setting	Lid
Cooking rice pudding						
Rice pudding, cooked with the lid on Temperature of the milk: 7 °C Heat the milk until it starts to rise up. Set the recommended heat setting and add rice, sugar and salt to the milk. The cooking time, including preheating, is approx. 45 minutes.						
Ingredients: 190 g short-grain rice, 90 g sugar, 750 ml milk (3.5% fat content) and 1 g salt	Cooking pot, 16 cm diameter	8.5	Approx. 5:30	No	3 (stir after 10 minutes)	Yes
Ingredients: 250 g short-grain rice, 120 g sugar, 1 l milk (3.5% fat content) and 1.5 g salt	Saucepan, 22 cm diameter	8.5	Approx. 5:30	No	3 (stir after 10 minutes)	Yes
Rice pudding, cooked without lid Temperature of the milk: 7 °C Add the ingredients to the milk and heat the mixture up while stirring continuously. Once the milk has reached approx. 90 °C, select the recommended heat setting and leave it to simmer on a low heat for approx. 50 minutes.						
Ingredients: 190 g short-grain rice, 90 g sugar, 750 ml milk (3.5% fat content) and 1 g salt	Cooking pot, 16 cm diameter	8.5	Approx. 5:30	No	3	No
Ingredients: 250 g short-grain rice, 120 g sugar, 1 l milk (3.5% fat content) and 1.5 g salt	Saucepan, 22 cm diameter	8.5	Approx. 5:30	No	2.5	No
Cooking rice*						
Water temperature: 20 °C						
Ingredients: 125 g long grain rice, 300 g water and a pinch of salt	Cooking pot, 16 cm diameter	9	Approx. 2:30	Yes	2	Yes
Ingredients: 250 g long grain rice, 600 g water and a pinch of salt	Saucepan, 22 cm diameter	9	Approx. 2:30	Yes	2.5	Yes
Roasting a pork loin						
Initial temperature of the loin: 7 °C						
Amount: 3 pork loins (total weight approx. 300 g, 1 cm thick) and 15 ml sunflower oil	Frying pan, 24 cm diameter	9	Approx. 1:30	No	7	No
Preparing pancakes**						
Amount: 55 ml batter for each pancake	Frying pan, 24 cm diameter	9	Approx. 1:30	No	7	No
Deep-fat frying chips						
Amount: 2 l sunflower oil, per portion: 200 g frozen chips (e.g. McCain 123 Original fries)	Saucepan, 22 cm diameter	9	Until the oil temperature reaches 180 °C	No	9	No
*Recipe in accordance with DIN 44550						
**Recipe in accordance with DIN EN 60350-2						



Handwriting practice lines consisting of multiple horizontal lines across the page.

BSH Hausgeräte GmbH
Carl-Wery-Str. 34, 81739 München
GERMANY

siemens-home.bsh-group.com

Manufactured by BSH Hausgeräte GmbH under Trademark License of Siemens AG



9001240877
971205(00)