



SIEMENS



Washing machine

WM12W440IN

siemens-home.com/welcome

en Instruction Manual and Installation Instructions

Register
your
product
online

Your new washing machine

You have chosen a Siemens washing machine.

Please take a few minutes to read and become familiar with the advantages of your washing machine.

To meet the high quality demands required by Siemens, every washing machine that leaves our factory is carefully checked to ensure that it functions correctly and is in perfect condition.

For more information on our products, accessories, replacement parts and services, see our website www.siemens-home.com or contact our after-sales service centres.

If the operating and installation instructions describe different models, any differences will be pointed out at the relevant points in the text.



Read these operating and installation instructions before switching on the washing machine.

Display rules

Warning!

This combination of symbol and signal word indicates a possibly dangerous situation. Not heeding the warning can cause death or injuries.

Caution!

This signal word indicates a possibly dangerous situation. Not heeding the caution can cause property and/or environmental damage.

Note/tip

Information about the optimum use of the appliance/any other useful information.

1. 2. 3. / a) b) c)

The steps are represented by numbers or letters.

■ / -

Lists are represented by a small box or a dash.

Contents

 Intended use	4
--	---

 Safety instructions	5
---	---

Electrical safety	5
Risk of injury	5
Safety for children	6

 Environmental protection	7
--	---

Packaging/used appliance	7
Tips on economical use	7

 Main points in brief	8
--	---

 Getting to know the appliance	9
---	---

Washing machine	9
Control panel	10
Display panel	11

 Laundry	12
---	----

Prepare the laundry	12
Sorting laundry	12

 Detergent	13
---	----

Correct selection of detergent	13
Saving energy and detergent	13



 Overview of programmes	14
---	----

Programmes on the programme selector	14
Starching	17
Dyeing/bleaching	17
Soaking	17

 Programme default settings	18
--	----

Temperature	18
Spin speed	18
Finish in	18

 Additional programme settings	19
--	----

ecoPerfect 	19
speedPerfect 	19
Easy Iron	19
Extra Rinse	19

 Operating the appliance	20
--	----







Preparing the washing machine	20
Switching on the appliance/ selecting a programme	20
Placing laundry into the drum	20
Measure and add detergent and care products	21
Change the programme default settings	22
Select additional programme settings	22
Start the programme	22
Child lock	22
Adding laundry	23
Changing the programme	23
Cancel the programme	23
Programme end during rinse hold	23
Programme end	23
Removing laundry/switching off the appliance	24

 Appliance settings	25
--	----

Activating the setting mode	25
Changing the signal volume	25
Selecting/deselecting the appliance automatic switch-off	25
Exiting setting mode	25

 Sensors	26
--	----

Automatic load sensing	26
Unbalanced load detection system	26
AquaSensor	26

	Cleaning and maintenance . . .	27
	Machine housing/control panel	27
	Drum	27
	Descaling	27
	Detergent drawer and housing	28
	The drain pump is blocked, emergency draining	28
	The drain hose at the siphon is blocked	29
	Filter in the water supply blocked . . .	29
	Faults and what to do about them.	30
	Emergency release	30
	Information on the display panel . . .	31
	Faults and what to do about them. . .	32
	After-sales service	34
	Consumption rates	35
	Energy and water consumption, programme duration and residual moisture for the main washing programmes	35
	Technical data	36
	Positioning and connecting. . .	37
	Included with the appliance	37
	Safety instructions	38
	Installation surface	38
	Installation on a base or a wooden joist floor	38
	Installation on a platform with drawer	38
	Installing the appliance in a kitchenette	39
	Removing the transport locks	39
	Hose and cable lengths	40
	Water inlet	41
	Water outlet	42
	Levelling	43
	Electrical connection	44
	Before washing for the first time . . .	45
	Transportation	46
	Aqua-Stop warranty	47

Intended use

- For private domestic use only.
- The washing machine is suitable for washing machine-washable fabrics and hand-washable wool in detergent solution.
- To be operated with cold mains water and standard detergents and care products which are suitable for use in front-loading washing machines. Do not use detergents for hand wash.
- When measuring the amount of all detergents/additives/care products and cleaning agents, always check the manufacturer's instructions.
- The washing machine may be used by children over the age of 8 years old and by persons with reduced physical, sensory or mental capacity or by persons with a lack of experience or knowledge if they **are supervised** or have **been instructed** by a responsible person. Children must not perform cleaning or maintenance work unsupervised.
- Keep children under the age of 3 years away from the washing machine.
- This appliance is intended for use up to a maximum height of 4000 metres above sea level.
- Keep pets away from the washing machine.

Read the Instruction Manual and Installation Instructions and all other information supplied with the washing machine and use the machine accordingly.

Retain the documents for subsequent use.

Safety instructions

Electrical safety

Warning

Risk of death!

There is a risk of electric shock if you touch live components.

- Never touch or hold the mains plug with wet hands.
- Only pull out the mains cable by the plug and never by the cable, as this could damage it.
- The appliance must be grounded.
Electrical connection
→ *Page 44*

Risk of injury

Warning

Risk of injury!

- When the washing machine is lifted by its protruding parts (e.g. the washing machine door), the components may break off and cause injuries.
Do not lift the washing machine by protruding parts.
- If you climb on the washing machine, the worktop may break and cause injuries.
Do not climb onto the washing machine.

- If you lean on the washing machine door when it is open, the washing machine may tip over and cause injuries.
Do not lean on the washing machine door when it is open.
- Reaching into the drum when it is turning can cause injuries to hands.
Do not reach into the drum when it is turning.
Wait until the drum has stopped turning.

Warning

Risk of scalding!

When you are washing at high temperatures, there is a risk of scalding if you come into contact with hot water e.g. if hot water is being drained into a wash basin.
Do not reach into the hot detergent solution.

Safety for children

Warning

Danger of death!

If children play with the washing machine, they may get into life-threatening situations or injure themselves.

- Do not leave children unattended near the washing machine.
- Do not let children play with the washing machine.

Warning

Danger of death!

Children may lock themselves in appliances, putting their lives at risk.

For appliances that have reached the end of their service life:

- Disconnect the mains plug.
- Cut through the mains cable and remove it, along with plug.
- Destroy the lock on the washing machine door.

Warning

Risk of suffocation!

Children may become wrapped in packaging/film or packing parts if allowed to play with them, or they may pull them over their heads and suffocate. Keep packaging, film and packaging parts out of the reach of children.

Warning

Risk of poisoning!

Detergents and care products may be poisonous if consumed.

Keep detergents and care products out of the reach of children.

Warning

Eye/skin irritation!

Detergents and care products may cause irritation if they come into contact with the eyes or skin.

Keep detergents and care products out of the reach of children.

Warning

Risk of injury!

When you wash at high temperatures, the glass in the washing machine door gets hot.

Do not let children touch the hot washing machine door.



Environmental protection

Packaging/used appliance



Dispose of packaging in an environmentally-responsible manner.

This appliance is certified in accordance with the guidelines on E-waste (Management) Rules 2016 which govern waste electrical and electronic equipment. The guidelines provide a framework for the return and recycling of used appliances.

Note: This product doesn't contain any of hazardous substances as specified in the E-waste (Management) Rules 2016.

Do's

- Hand over the old/discarded electronic equipment only to authorized collection centers for disposal
<http://www.siemens-home.com/in/preserve.html>
See also:

Contact No: 180042535287 (toll-free)
E-mail: recycle@ewasteindia.com
Online website: www.ewasteindia.com

- Consult the authorized service center as to whether the Electronic Equipment can be repaired or not, before discarding
- Consult the retailer about appliance take back schemes

Don'ts











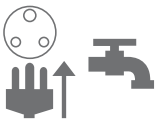
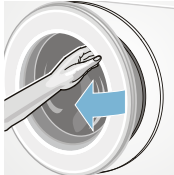

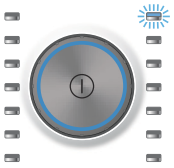
- Don't dump the discarded Electronic Equipment in the open or in any land fill site, as this will result in contamination of the soil and the ground water
- Don't dispose of the discarded Electronic Equipment in household bins or Municipal bins

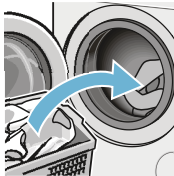
- The product is not meant for re-sale to any unauthorized agencies/scrap dealers
- Don't keep any replaced spare part(s) from the product in an exposed area

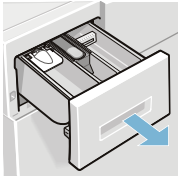
Tips on economical use

- Always fill the appliance with the maximum amount of laundry for the relevant programme.
Overview of programmes
→ *Page 14*
- Wash normally soiled laundry without a prewash.
- Save energy and detergent when washing lightly and normally soiled laundry. → *Page 13*
- The selectable temperatures apply to the care labels on the textiles. The temperatures in the machine may deviate from this so that you get the optimum mix of energy-saving and washing results.
- **Energy-saving mode:** The display panel lighting goes out after a few minutes and the ►|| button flashes. Press any button to activate the lighting.
Energy-saving mode is not activated if a programme is running.
- **Automatic switch off:** If the appliance is not operated for a prolonged period, it may automatically switch off before the programme starts and when the programme has ended to save energy. Press the main switch again to switch on the appliance.
Switching the → *Page 25* function on/off
- If the laundry is subsequently dried in a tumble dryer, select the spin speed according to the tumble dryer manufacturer's instructions.

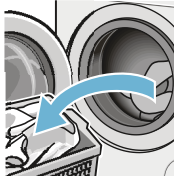
Main points in brief

1				
	Connect the mains plug. Turn on the tap.	Open the door.	To switch on, press the ⏻ button.	Select a programme, e.g. Cottons .
2				
	Sort the laundry.	Observe the maximum load (depending on the model) on the display panel.	Load the laundry.	Close the door.
3				
	Add detergent.	If necessary, change the default programme settings and/or select additional settings.	Start the programme.	
4				
	End of the programme	Open the door and remove the laundry.	To switch off, press the ⏻ button.	Turn off the tap (for models without Aqua-Stop).

Getting to know the appliance

Washing machine

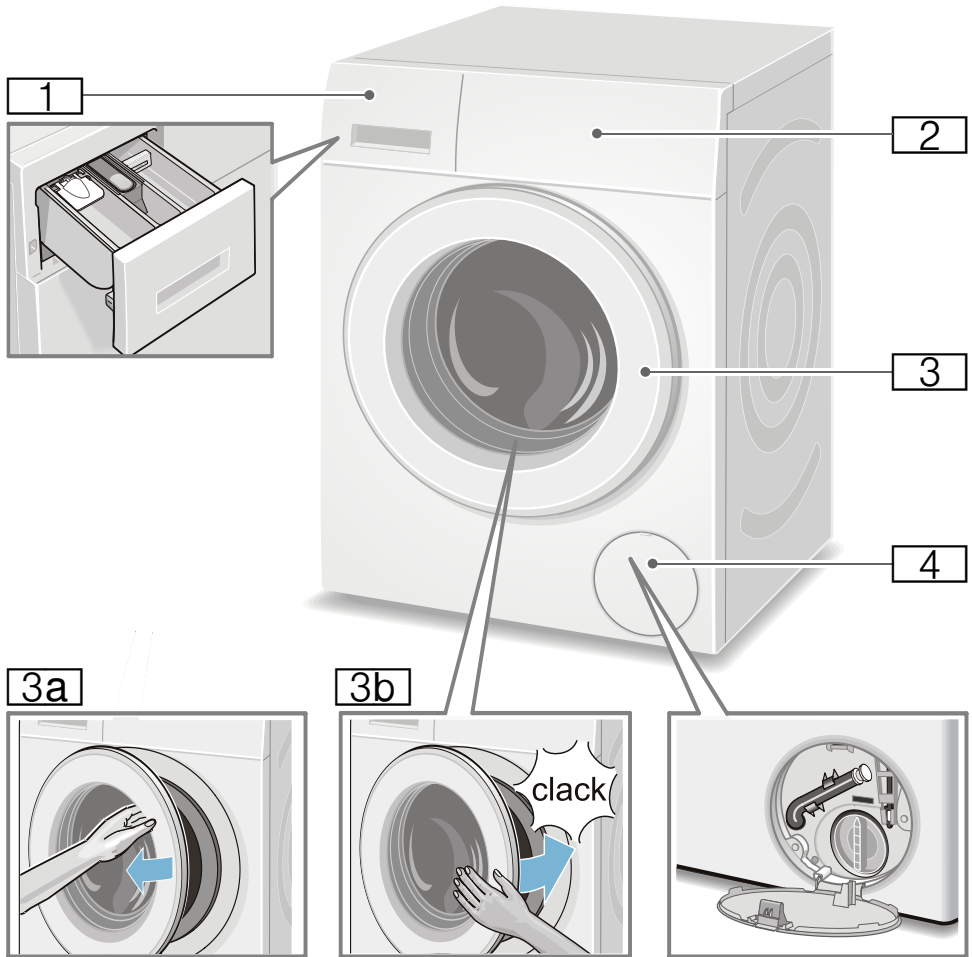



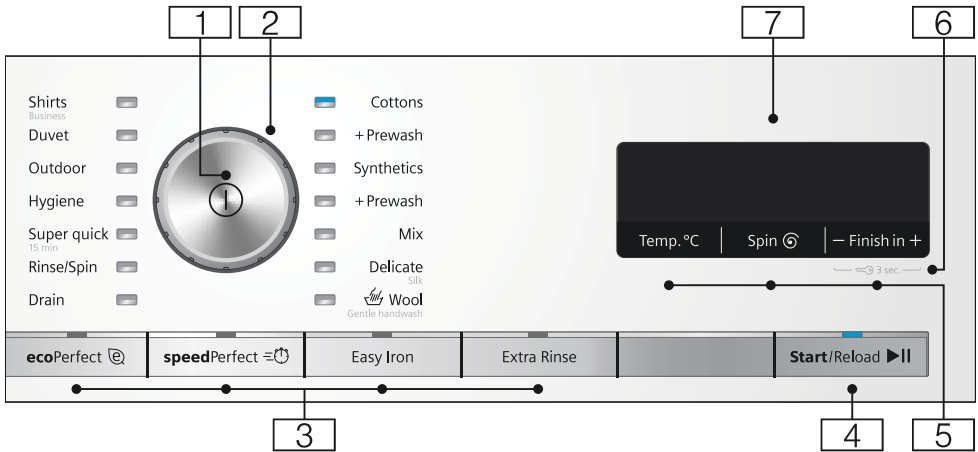

- 1 Detergent drawer → Page 21
- 2 Operating/display panel
- 3 Door with door handle
- 3a Open the door
- 3b Close the door
- 4 Service flap

Control panel



Note: All the buttons are sensitive (except for the main switch) and only need to be pressed lightly.

- 1 Main switch**
for switching the washing machine on and off:
Press the ① button.
- 2 Programme selector**
for selecting a programme.
Overview of programmes
→ Page 14
- 3 Additional programme settings:**
→ Page 19
 - ecoPerfect ,
 - speedPerfect ,
 - Extra Rinse,
 - Easy Iron
- 4 ▶|| button for:**
 - Starting a programme
 - Interrupting a programme, e.g. to add items of laundry
→ Page 23
 - Cancelling a programme
→ Page 23

- 5 Changing the default programme settings:** → Page 18
 - Temperature (Temp. °C),
 - Spin speed (Spin ) ,
 - Finish in time
- 6 Child lock** ( 3 sec.)
to prevent the set functions from being changed accidentally:
To do so, press **Finish in +** and **-** simultaneously for approx. 3 seconds. → Page 22
- 7 Display panel** for settings and information. → Page 11

Display panel

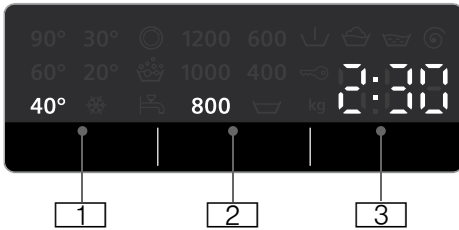

Default programme settings:

- 1 **Temperature** in °C
* - 90 (* = cold)
- 2 **Spin speed** in rpm,
▽ - 1600*;
* Max. spin speed, depending on the selected programme and model,
▽ = Rinse Stop → *Page 18*
- 3 **Finish in time**
e.g. 2:30;
Programme duration depends on the programme selection in h:min (hours:minutes),
- **Preselection of end time**
1 - 24 h;
Programme ends after ... h (h = hours)
- **Load recommendation**
e.g. kg 8*;
* depending on the selected programme

Further information

Programme progress:

	Prewash
	Washing
	Rinse
	Spin
- 0 -	Programme end
	Programme end during Rinse Stop
- P -	Pause, e.g. to reload laundry

Washing machine door:

	The washing machine door can be opened.
	When the programme has started: The washing machine door is not closed properly.

Tap:

	Tap not turned on, no water pressure
	Water pressure too low (may increase the programme duration)

Childproof lock: → *Page 22*

	Childproof lock activated
	Childproof lock activated, programme selector adjusted

Foam detection:

	→ <i>Page 22</i>
lights up	

Fault display:

E: --	→ <i>Page 31</i>
-------	------------------

Signal setting:

0 - 4	→ <i>Page 25</i>
-------	------------------

Switching off the appliance automatically:

On OFF	→ <i>Page 7</i> , → <i>Page 25</i>
--------	------------------------------------



Laundry

Prepare the laundry

Caution!

Damage to the appliance/fabrics

Foreign objects (e.g. coins, paperclips, needles, nails) may damage the laundry or components in the washing machine.

You should therefore note the following tips when preparing your laundry:

- Empty any pockets.

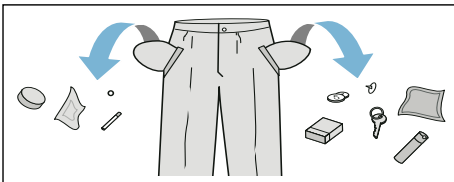

- Look out for metal items (paperclips, etc.) and remove them.
- Wash delicates in a laundry bag (tights, underwired bras, etc.).
- Close any zips; button up any cover buttons.
- Brush sand out of pockets and collars.
- Remove curtain fittings or place curtains in a laundry bag.

Sorting laundry

Sort your laundry according to the care instructions and manufacturer's information on the care labels, depending on:







- Type of fabric/fibre
- Colour
 - Note:** Laundry may discolour. Wash white and coloured items separately. Wash new coloured items separately the first time you wash them.
- Soiling
 - Wash laundry with the same level of soiling together.

Some examples of soiling levels can be found on → *Page 13*

- **Light:** Do not prewash, select the **speedPerfect**  setting if necessary
- **Normal**
- **Heavy:** Load less laundry, select a programme with prewash
- **Stains:** Remove/pretreat stains while they are fresh. Firstly, dab with soapy water; do not rub. Then wash the items of laundry with the appropriate programme. Stubborn or dried-in stains can sometimes only be removed by washing several times.

- Symbols on the care labels

Note: The numbers in the symbols indicate the maximum washing temperature that may be used.

-  Suitable for normal washing process; e.g. Cottons programme
-  A gentle washing process is required; e.g. Easy-Care programme
-  An especially gentle washing process is required; e.g. Delicate/Silk programme
-  Suitable for washing by hand; e.g.  Woollens programme
-  Do not machine wash.

Detergent

Correct selection of detergent

The care label is crucial for selecting the correct detergent, temperature and treatment of the laundry. → See also www.sartex.ch

If you visit www.cleanright.eu, you will find further information on detergents, care products and cleaning agents for domestic use.

- **Standard detergent with optical brighteners**

Suitable for boil-washable white laundry made from linen or cotton
Programme: Cottons/
cold - max. 90 °C

- **Detergent for colours without bleach or optical brighteners**

Suitable for coloured laundry made from linen or cotton
Programme: Cottons/
cold - max. 60 °C

- **Detergent for colours/delicates without optical brighteners**

Suitable for coloured laundry made from easy-care fibres, synthetic fibres
Programme: Easy-Care/
cold - max. 60 °C

- **Detergent for delicates**

Suitable for delicate, fine fabrics, silk or viscose
Programme: Delicate/Silk/
cold - max. 40 °C

- **Detergent for woollens**

Suitable for wool
Wool programme/
cold - max. 40 °C

Saving energy and detergent















For light and normal soiling, you can save energy (lower washing temperature) and detergent.







Saving	Soiling/note
Reduced temperature and detergent quantity as per the recommended dosage 	Light No visible dirt or stains. Clothing has taken on some body odour, e.g.: <ul style="list-style-type: none"> ■ Light summer/sports clothing (worn for a few hours) ■ T-shirts, shirts, blouses (worn for up to one day) ■ Guest bed linen and hand towels (used for one day)
	Normal Visible dirt or a few light stains, e.g.: <ul style="list-style-type: none"> ■ T-shirts, shirts, blouses (sweat soaked, worn a few times) ■ Towels, bedding (used for up to one week)
	Heavy Dirt and/or stains clearly visible, e.g. tea towels, baby items, work clothing
Temperature as per the care label and detergent quantity as per the recommended dosage for heavy soiling	











Note: When measuring the amount of all detergents/additives/care products and cleaning agents, please always check the manufacturer's instructions and information. → *Page 21*





Overview of programmes

Programmes on the programme selector

Programme/type of laundry/information	Settings
<p>Programme name</p> <p>Brief explanation of the programme and for which fabrics it is suitable.</p>	<p>Max. load</p> <p>Temperature that can be selected (❄ = cold)</p> <p>Spin speed that can be selected^{**};  = Rinse Stop</p> <p>Additional programme settings that can be selected</p>
<p>Cottons</p> <p>Hard-wearing fabrics, heat-resistant fabrics made of cotton or linen;</p> <p>Cottons + Prewash: Programme with prewash; divide the detergent between compartments I and II</p> <p>Notes</p> <ul style="list-style-type: none"> ■ For the ecoPerfect  setting, the wash temperature is lower than the selected temperature. If you would like to set a particular washing temperature, use the programme without the ecoPerfect  setting or, if necessary, set a higher temperature. ■ The speedPerfect  setting is suitable as a short programme for lightly soiled laundry. 	<p>Max. 8 kg/5* kg</p> <p>❄ - 90 °C</p> <p> - 1600** rpm</p> <p>ecoPerfect , speedPerfect ,</p> <p>Easy Iron,</p> <p>Extra Rinse</p>
<p>Synthetics</p> <p>Synthetic or blended fabrics;</p> <p>Synthetics + Prewash: Programme with prewash; divide the detergent between compartments I and II</p>	<p>Max. 4 kg</p> <p>❄ - 60 °C</p> <p> - 1200 rpm</p> <p>ecoPerfect , speedPerfect ,</p> <p>Easy Iron,</p> <p>Extra Rinse</p>
<p>Mix</p> <p>Mixed load of cottons and synthetic fabrics</p>	<p>Max. 4 kg</p> <p>❄ - 40 °C</p> <p> - 1600** rpm</p> <p>ecoPerfect , speedPerfect ,</p> <p>Easy Iron,</p> <p>Extra Rinse</p>
<p>* Reduced load for the speedPerfect  setting</p> <p>** Max. spin speed, depending on the model</p> <p>*** Programme depending on the model</p>	

Programme/type of laundry/information	Settings
<p>Delicate / Silk</p> <p>For delicate, washable fabrics, e.g. made of silk, satin, synthetic fibres or blends (e.g. silk blouses, silk scarves)</p> <p>Note: . Use a detergent suitable for machine-washing delicates or silk.</p>	<p>Max. 2 kg</p> <p>✳ - 40 °C</p> <p>🌀 - 800 rpm</p> <p>ecoPerfect , speedPerfect ,</p> <p>Easy Iron,</p> <p>Extra Rinse</p>
<p> Wool / Gentle handwash</p> <p>Hand- or machine-washable fabrics that are made of wool or contain wool;</p> <p>particularly gentle wash programme to prevent laundry from shrinking, with longer pauses in the programme (during which the items rest in the water)</p> <p>Notes</p> <ul style="list-style-type: none"> ■ Wool is of animal origin, e.g.: Angora, alpaca, llama, sheep. ■ Use a detergent that is suitable for machine-washing wool. 	<p>Max. 2 kg</p> <p>✳ - 40 °C</p> <p>🌀 - 800 rpm</p> <p>-</p>
<p>Drain</p> <p>For the rinsing water, e.g. after the 🌀 setting (Rinse Stop = no final spin cycle)</p>	<p>-</p> <p>-</p> <p>-</p> <p>-</p>
<p>Rinse / Spin</p> <p>Extra rinse/spin with speed that can be selected</p> <p>Note: . The Extra Rinse button is set by default for this programme. If you require a spin cycle only, press the button to deactivate the function.</p>	<p>-</p> <p>-</p> <p>🌀 - 1600** rpm</p> <p>Easy Iron</p>
<p>Super quick 15 min</p> <p>Extra-short programme of approx. 15 minutes, suitable for small items of lightly soiled laundry</p>	<p>Max. 2 kg</p> <p>✳ - 40 °C</p> <p>🌀 - 1200 rpm</p> <p>-</p>
<p>*** Dark Wash</p> <p>Dark-coloured cottons and dark-coloured easy-care fabrics; turn items inside-out before washing.</p>	<p>Max. 3.5 kg</p> <p>✳ - 40 °C</p> <p>🌀 - 1200 rpm</p> <p>ecoPerfect , speedPerfect ,</p> <p>Easy Iron,</p> <p>Extra Rinse</p>
<p>* Reduced load for the speedPerfect  setting</p> <p>** Max. spin speed, depending on the model</p> <p>*** Programme depending on the model</p>	

Programme/type of laundry/information	Settings
<p>*** Hygiene</p> <p>Hard-wearing fabrics made of cotton or linen</p> <p>Note: . Particularly suited to washing items that need to be hygienically clean and especially kind to sensitive skin thanks to the longer wash cycle at a defined temperature, higher water level and longer spin cycle.</p>	<p>Max. 7 kg/5* kg</p> <p>❄ - 60 °C</p> <p>☰ - 1600** rpm</p> <p>ecoPerfect , speedPerfect ,</p> <p>Easy Iron,</p> <p>Extra Rinse</p>
<p>*** Outdoor / Impregnation</p> <p>Wash cycle followed by waterproofing of membrane-coated weatherproof and outdoor clothing or water-resistant fabrics</p> <ol style="list-style-type: none"> 1. Select a programme. 2. Add special detergent for outdoor clothing to compartment II. 3. Add waterproofing agent (max. 170 ml) to compartment . 4. Press the  button. After-treat the laundry in accordance with the manufacturer's instructions. <p>Notes</p> <ul style="list-style-type: none"> ■ Use a special detergent suitable for machine washing and dose in accordance with the manufacturer's instructions: ■ Laundry must not be treated with fabric softener. ■ Before washing, clean the detergent drawer thoroughly (all compartments) to remove fabric-softener residue. 	<p>Max. 1 kg</p> <p>❄ - 40 °C</p> <p>☰ - 800 rpm</p> <p>ecoPerfect , speedPerfect ,</p> <p>Extra Rinse</p>
<p>*** Outdoor</p> <p>Membrane-coated weatherproof or outdoor clothing and water-resistant fabrics</p> <p>Notes</p> <ul style="list-style-type: none"> ■ Use special detergent suitable for machine washing; add the correct dosage to compartment II in accordance with the manufacturer's instructions. ■ Laundry must not be treated with fabric softener. ■ Before washing, clean the detergent drawer thoroughly (all compartments) to remove fabric-softener residue. 	<p>Max. 2 kg</p> <p>❄ - 40 °C</p> <p>☰ - 800 rpm</p> <p>ecoPerfect , speedPerfect ,</p> <p>Extra Rinse</p>
<p>*** Sportswear</p> <p>Sportswear and leisurewear made from microfibre fabrics;</p> <p>Notes</p> <ul style="list-style-type: none"> ■ Laundry must not be treated with fabric softener. ■ Before washing, clean the detergent drawer thoroughly (all compartments) to remove fabric-softener residue. 	<p>Max. 2 kg</p> <p>❄ - 40 °C</p> <p>☰ - 800 rpm</p> <p>ecoPerfect , speedPerfect ,</p> <p>Easy Iron,</p> <p>Extra Rinse</p>
<p>* Reduced load for the speedPerfect  setting</p> <p>** Max. spin speed, depending on the model</p> <p>*** Programme depending on the model</p>	

Programme/type of laundry/information	Settings
<p>*** Duvet</p> <p>Machine-washable items stuffed with synthetic fibres, such as pillows, quilts and bedspreads; also suitable for items stuffed with down</p> <p>Note: . Wash large items separately. Use a detergent designed for delicates and follow the instructions on the item's care label. Use detergent sparingly.</p>	<p>Max. 2.5 kg</p> <p>✳ - 60 °C</p> <p>☪ - 1200 rpm</p> <p>ecoPerfect , speedPerfect , Extra Rinse</p>
<p>Shirts / Business</p> <p>Non-iron shirts or blouses made of cotton, linen, synthetic fibres or blended fabrics</p> <p>Notes</p> <ul style="list-style-type: none"> ■ Shirts/blouses are only given a short spin on the Easy Iron setting. Hang them up to dry while still dripping wet. -> Self-smoothing effect ■ Use the Delicate / Silk programme to wash shirts/blouses made of silk or delicate fabrics. 	<p>Max. 2 kg</p> <p>✳ - 60 °C</p> <p>☪ - 800 rpm</p> <p>ecoPerfect , speedPerfect , Easy Iron, Extra Rinse</p>
<p>* Reduced load for the speedPerfect  setting</p> <p>** Max. spin speed, depending on the model</p> <p>*** Programme depending on the model</p>	

Starching

Note: Laundry should not be treated with fabric softener.

Liquid starch can be used to stiffen fabrics particularly in the Rinse and Cottons programmes. Measure starch into compartment  in accordance with the manufacturer's instructions (clean first if necessary).

Dyeing/bleaching

Dye should only be used in normal household quantities. Salt may damage stainless steel. Always follow the dye manufacturer's instructions.

Do **not** use the washing machine to bleach clothes.

Soaking

1. Switch on the appliance.
2. Select the **Cottons 30 °C** programme.
3. Pour soaking agent/detergent into compartment **II** in accordance with the manufacturer's instructions.
4. Press the **▶||** button. The programme starts.
5. After approx. 10 minutes, press the **▶||** button to pause the programme.
6. Leave the laundry to soak for as long as required, then either press the **▶||** button again to continue the programme or change the programme.

Notes

- Load laundry of the same colour.
- No additional detergent is required; the soaking solution is used for washing.

P+ Programme default settings

The default programme settings are displayed in the display panel after selecting the programme.

You can change the default settings.

An overview of all programme settings, which can be selected depending on the programme, can be found from → *Page 14*.

Temperature

(Temp. °C)

Depending on what stage the programme is in, you can change the set temperature before and during the programme.

The maximum temperature that can be set depends on the programme that has been selected.

Spin speed

(Spin )

Depending on what stage the programme is in, you can change the spin speed (in rpm; revolutions per minute) before and during the programme.

Setting : Rinse Stop = no final spin. The laundry stays in the water after the final rinse.

You can select "Rinse Stop" to prevent creasing if the laundry will not be taken out of the washing machine immediately after the programme has ended.

To continue/end the programme
→ *Page 23*

The maximum speed that can be set depends on the model and programme that has been selected.

Finish in

Before starting the programme, you can preselect the programme end ("Ready in" time) in hourly increments (h = hour) up to a maximum of 24 hours.

To do this:

1. Select a programme.
The programme duration is displayed for the selected programme, e.g. **2:30** (hours:minutes).
2. Press the **Finish in** button repeatedly until the required number of hours is displayed.
Note: The setting values are increased using the **Finish in +** button, and decreased using the **Finish in -** button.
3. Press the **▶||** button.
The programme starts.
The selected number of hours (e.g. **8 h**) is shown in the display panel and counts down until the wash programme starts. The duration of the programme is then displayed.

Note: The length of the programme is automatically adjusted when the programme is running. Changes to the default programme settings or programme settings may also change the programme duration.

After starting the programme

(if a Finish in time has been selected and the wash programme has not yet started), you can change the preselected number of hours as follows:

1. Press the **▶||** button.
2. Use the **Finish in -** or **+** button to change the number of hours.
3. Press the **▶||** button.

After starting the programme, you can add or remove laundry if necessary.
→ *Page 23*

P+ Additional programme settings

An overview of all additional settings, which can be selected depending on the programme, can be found from → *Page 14*.

ecoPerfect

Energy-optimised washing by reducing the temperature while achieving a washing result that is consistent with the selected programme, without the ecoPerfect  setting.

speedPerfect

Washing in a shorter time while achieving a washing result that is consistent with, but uses more energy than, the selected programme, without the speedPerfect  setting.

Note: Do not exceed the maximum load.

Overview of programmes → *Page 14*

Easy Iron

Reduces creasing thanks to a special spin sequence followed by fluffing and reduced spin speed.

Note: The washing's residual moisture is increased.

Extra Rinse

Additional rinse cycle for particularly sensitive skin and/or for areas with very soft water.



Operating the appliance

Preparing the washing machine

Note: The washing machine **must be correctly installed and connected.**

From → Page 37.

1. Connect the mains plug.
2. Turn on the tap.
3. Open the door.
4. Check that the drum is completely drained. Drain if necessary.

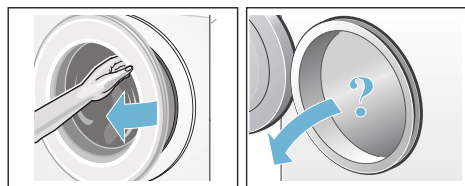

Switching on the appliance/ selecting a programme

Press the **Ⓚ** button. The appliance is switched on.

The **Cottons** programme set at the factory is then always displayed.

You can use this programme or select a different programme. The programme selector can be turned in either direction.

Note: If you have activated the childproof lock, you must deactivate it before you can set a different programme. → Page 22

The indicator lamp on the programme selector lights up and the **default programme settings** for the selected programme appear in the display panel:

- Temperature
- Spin speed and

- The maximum load and the duration of the programme (alternately)

In appliances with a **drum light**:

The drum is lit after switching on the appliance, after opening and closing the door and after starting the programme. The light switches off automatically.

Placing laundry into the drum



Warning **Danger of death!**

Items of laundry pretreated with cleaning agents that contain solvents, e.g. stain remover/cleaning solvent, may cause an explosion after being loaded into the washing machine. Hand-rinse these items of laundry thoroughly beforehand.

Notes

- Mix items of laundry of varying sizes. Laundry items of different sizes distribute themselves better during the spin cycle. Individual laundry items may cause an unbalanced load.
 - Observe the maximum specified load. Overfilling adversely affects the washing result and promotes creasing.
1. Unfold presorted laundry items and place them in the drum.
 2. Make sure that no items of laundry are trapped between the door and the rubber seal, and close the door.

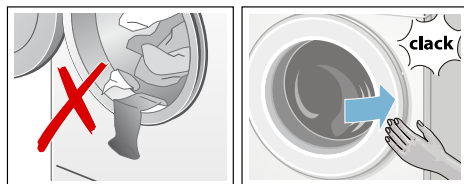

The **▶▶** button indicator lamp flashes and the programme settings appear in the display panel.

Measure and add detergent and care products

Caution!

Damage to the appliance

Cleaning agents and agents for pre-treating laundry (e.g. stain removers, prewash sprays, etc.) may cause damage if they come into contact with the surfaces of the washing machine. Do not allow these agents to come into contact with the surfaces of the washing machine. If necessary, immediately wipe away spray residue and other residues/droplets with a damp cloth.

Dosing

Dose the detergents and care products according to:

- Water hardness (ask your water supply company)
- The manufacturer's instructions on the packaging
- The amount of laundry
- Soiling → *Page 13*

Filling

Warning **Eye/skin irritation!**

Detergents and care products may spray out if the detergent drawer is opened while the machine is in operation. Open the drawer carefully. Rinse eyes/skin thoroughly if they come into contact with detergents or care products. If accidentally swallowed, seek medical advice.

Note: Dilute viscous fabric softener and fabric conditioner with a little water. This prevents blockages in the washing machine's piping.

Pour the detergent and care products into the appropriate compartments:

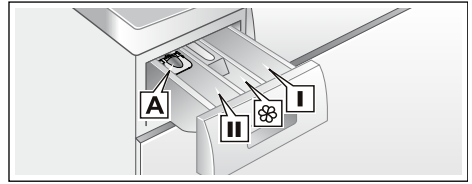

- Measuring aid **A** For liquid detergent
 Compartment **II** Detergent for the main wash, water softener, bleach, stain remover
 Compartment  Fabric softener, liquid starch; do not exceed **max.**
 Compartment **I** Detergent for prewash

1. Pull out the detergent drawer as far as possible.
2. Add detergent and/or care products.
3. Close the detergent drawer.

Measuring aid* for liquid detergent

*depending on the model

- Position the measuring aid for dosing the correct amount of liquid detergent:
1. Pull out the detergent drawer. Press down the insert and fully remove the drawer.
 2. Slide the measuring aid forwards, fold it down and click it into place.
 3. Reinsert the drawer.

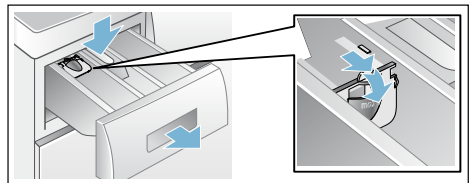

Note: Do not use the measuring aid for gel detergents and washing powder, or for programmes with prewash or when the "Ready in" time is selected.

For models without a measuring aid, pour the liquid detergent into the appropriate dispenser and place it in the drum.

Change the programme default settings

You can use or change the default settings for this washing cycle.

To do this, repeatedly press the corresponding button until the required setting is displayed.

Note: Pressing and holding the button automatically runs through the set values to the end. Then press the button once more and you can then change the setting values again.

The settings are activated without needing to be confirmed.

The settings are not saved after switching off the washing machine.

Default programme settings
→ *Page 18*

Select additional programme settings

By selecting additional settings, you can better adapt the washing process to your items of laundry.

The settings can be selected or deselected depending on the programme progress.

The button indicator lamps light up if a setting is activated.

The settings are not saved after switching off the washing machine.

Additional programme settings
→ *Page 19*

Start the programme

Press the ►|| button. The indicator lamp lights up and the programme starts.

Note: You will need to press and hold the ►|| button to start the programme. This prevents the programme from

being started if something accidentally brushes against the button.

The display panel shows the "Ready in" time while the programme is running or the programme length and the programme progress symbols when the washing programme has started.
Display panel → *Page 11*

Note: Foam detection

If the 🧼 symbol also lights up in the display panel, the washing machine has detected too much foam during the wash programme and automatically activated additional rinse cycles to remove the foam.

Add less detergent to the next washing cycle with the same load.

If you want to lock the programme to prevent it from being inadvertently adjusted, you can select the childproof lock as follows.

Child lock

(🔒 3 sec.)

You can lock the washing machine to prevent the functions you have set from being changed inadvertently. To do this, activate the childproof lock.

To **activate/deactivate**, press and hold the **Finish in -** and **+** buttons at the same time for approx. three seconds. The 🔒 symbol is appears in the display panel.

- 🔒 lights up: The childproof lock is active.
- 🔒 flashes briefly: The childproof lock is active and the programme selector was turned or a button was pressed.

Note: The childproof lock remains active, even once the washing machine has been switched off. Before selecting the next programme, deactivate the childproof lock.

Adding laundry

After starting the programme, you can add or remove laundry if necessary.

Press the ►|| button to do this.

The ►|| button indicator lamp flashes and the machine checks whether it is possible to add laundry.

If the following appears in the display panel:

- **Both** the - P - and © symbols light up, it is possible to add laundry.
- - P - lights up, it is not possible to add laundry.

To continue the programme, press the ►|| button. The programme continues automatically.

Notes

- Do not leave the door open for too long when adding laundry as water from the laundry may leak out.
- For safety reasons, the door remains locked when the water level or temperature is high, or while the drum is turning, and it is not possible to add laundry during this time.
- The load display is not active during reloading.

Changing the programme

If you have started the wrong programme by mistake, you can change the programme as follows:

1. Press the ►|| button.
2. Select another programme.
3. Press the ►|| button. The new programme starts from the beginning.

Cancel the programme

For programmes at high temperatures:

1. Press the ►|| button.
2. To cool down laundry: Select **Rinse**.
3. Press the ►|| button.

For programmes at low temperatures:

1. Press the ►|| button.
2. Select **Spin** or **Drain**.
3. Press the ►|| button.

Programme end during rinse hold

In the display panel, ☹ flashes, and the preset spin speed and remaining programme length are displayed for the selected programme.

Continue the programme by:

- Pressing the ►|| button or
- Changing the spin speed, or setting the programme selector to **Drain** and then pressing the ►|| button.

Programme end

- 0 - and © appear in the display panel. The ►|| button indicator lamp is off.

Removing laundry/switching off the appliance

1. Open the door and remove the laundry.
2. Press the  button. The appliance is switched off.
3. Turn off the tap.

Note: Not required for Aqua-Stop models.

Notes

- Do not leave any items of laundry in the drum. They may shrink in the next wash or discolour another item.
- Remove any foreign objects from the drum and the rubber seal – risk of rusting.
- Wipe the rubber seal dry.

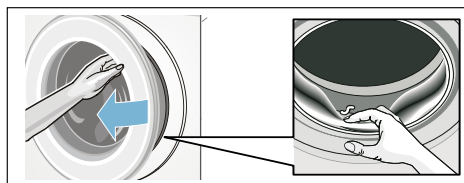

- Leave the door and detergent drawer open so that any residual water can evaporate. → *Page 27*
- Always wait until the programme ends, as the appliance could still be locked. Then switch the appliance on and wait for it to unlock.
- If the display panel goes off at the end of a programme, the energy-saving mode is active. Press any button to activate the panel.

Appliance settings

You can change the following settings:

- The volume of the buttons and information signals (e.g. at the end of the programme)
- Select/deselect the appliance's automatic switch-off function.
→ Page 7

You will need to activate the setting mode in order to change these settings.

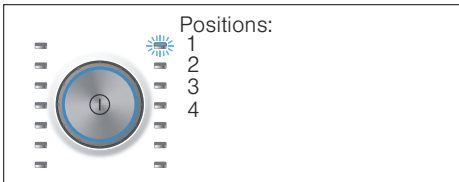

Activating the setting mode

1. Press the **⓪** button.
The appliance is switched on and the **Cottons** programme is shown at position 1.
2. Press the **Temperature** button and, at the same time, turn the programme selector clockwise to position 2. Release the button.
The setting mode is activated and the preset volume for the information signals appears in the display panel.

You can now change the settings:

Changing the signal volume

Use the **Finish in +** or **-** button to change the following settings at the corresponding programme selector positions:

- 2: The volume of the information signals and/or
- 3: The volume of the button signals.



0 = off,
1 = quiet,
2 = medium,
3 = loud,
4 = very loud

Exit setting mode or:

Selecting/deselecting the appliance automatic switch-off

With the programme selector in position 4, press the **Finish in +** or **-** button to switch the "Automatic switch-off" function on or off.

Exiting setting mode

To exit and save the settings, press the **⓪** button.

The appliance is switched off. The selected settings will take effect the next time the washing machine is switched on.

 **Sensors**

Automatic load sensing

Depending on the type of fabric and load, the automatic load sensing function optimally adjusts the water consumption and programme duration in each programme.

Unbalanced load detection system

The automatic unbalanced load detection system detects imbalances and ensures even distribution of the laundry by repeatedly starting and stopping drum spinning.

If the laundry is extremely unevenly distributed, the speed is reduced or the spin cycle is not performed for safety reasons.

Note: Place large and small items of laundry evenly in the drum.

→ Page 20, → Page 32

AquaSensor

depending on the model

During the rinse cycle, the AquaSensor checks the degree of turbidity (turbidity is caused by dirt and detergent residue) of the rinsing water. The duration and the number of rinse cycles depend on the turbidity of the water.



Cleaning and maintenance

Warning

Danger of death!

There is a risk of electric shock if you touch live components. Switch off the appliance and pull out the mains plug.

Warning

Risk of poisoning!

Toxic vapours can be produced by cleaning agents that contain solvents, e.g. cleaning solvent. Do not use cleaning agents that contain solvents.

Caution!

Damage to the appliance

Cleaning agents that contain solvents, e.g. cleaning solvent, can damage surfaces and components in the machine. Do not use cleaning agents that contain solvents.

Prevent detergent residue from building up and odours from forming by following these instructions:

Notes

- Ensure the room in which the washing machine is set up is well ventilated.
- Leave the door and detergent dispenser tray open slightly when the washing machine is not in use.
- Occasionally run a wash using the **Cottons 60 °C** programme and powder detergent.

Machine housing/control panel

- Wipe the housing and the control panel with a soft, damp cloth.
- Remove the detergent residue immediately.
- Do not clean with a water jet.

Drum

Use chlorine-free cleaning agents, do not use steel wool.

If there are odours in the washing machine, or to clean the drum, run the **Cottons 90 °C** programme without laundry. Add washing powder.

Descaling

Descaling should not be necessary if the detergent is measured out correctly. However, if it is required, follow the manufacturer's instructions for the descaling agent. Suitable descalers can be obtained via our website or from customer services. → *Page 34*

Detergent drawer and housing

If the washing machine contains detergent or fabric softener residues:

1. Pull out the detergent drawer. Press down the insert and fully remove the drawer.
2. To remove the insert: Push the insert upwards from below with your finger.

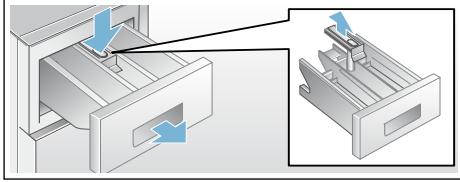

3. Clean the detergent dispenser tray and insert with water and a brush, and dry it. Clean the inside of the housing as well.
4. Fit the insert and lock it in place (push the cylinder onto the guide pin).
5. Push in the detergent drawer.

Note: Leave the detergent drawer open so that any residual water can evaporate.

The drain pump is blocked, emergency draining

Warning **Risk of scalding!**

When you wash at high temperatures, the water gets very hot. If you come into contact with the hot water, you may be scalded.

Allow the water to cool down.

1. Turn off the tap so that no more water can flow in and has to be drained via the drain pump.
2. Switch off the appliance. Pull out the mains plug.

3. Open and remove the service flap.

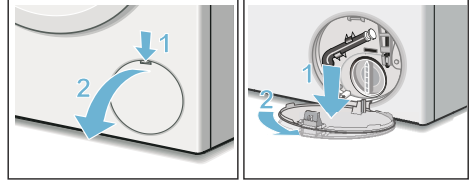

4. Take the drain hose out of the retainer. Remove the sealing cap and pour the water out into a suitable container. Replace the sealing cap and place the drain hose back in the retainer.

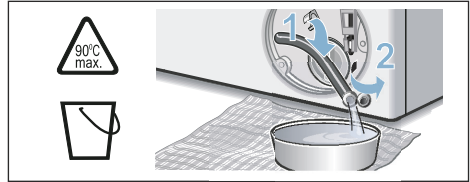

5. Carefully unscrew the pump cover; residual water may leak out. Clean the interior, pump-cover thread and pump housing. The impeller in the drain pump must be able to rotate. Refit the pump cover and screw it on tightly. The handle must be in a vertical position.

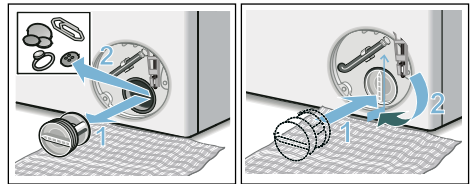

- Place the service flap back on, lock it into place, and close it.

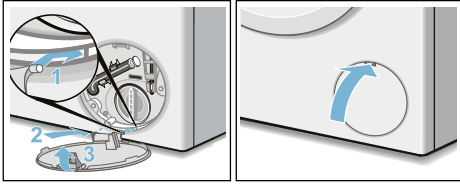

Note: To prevent unused detergent from flowing straight into the drain during the next wash: Pour 1 litre of water into compartment II and start the **Drain** programme.

The drain hose at the siphon is blocked

- Switch off the appliance. Pull out the mains plug.
- Loosen the hose clamp. Carefully remove the drain hose; residual water may leak out.
- Clean the drain hose and siphon connecting piece.

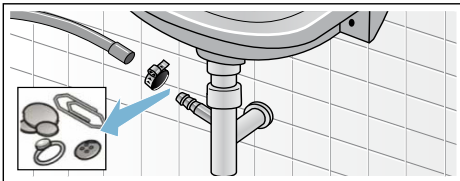

- Re-attach the drain hose and secure the connection point using the hose clamp.

Filter in the water supply hose blocked

First, reduce the water pressure in the supply hose:

- Turn off the tap.
- Select any programme (except Rinse/Spin/Empty).
- Press the ►|| button. Allow the programme to run for approximately 40 seconds.
- Press the Ⓛ button. The appliance is switched off.
- Pull out the mains plug.

Then clean the filter:

- Disconnect the hose from the tap. Clean the filter with a small brush.

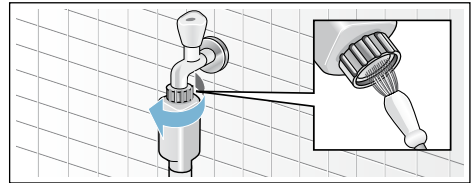

- For standard and Aqua-Secure models, clean the filter on the rear of the appliance: Remove the hose from the rear of the appliance. Use pliers to remove the filter and then clean it.

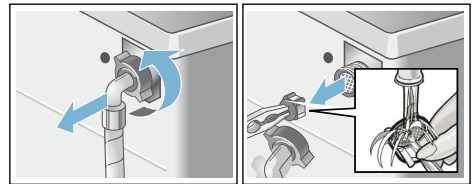

- Connect the hose and check for leaks.

Faults and what to do about them.

Emergency release

E.g. in the event of a power cut

The programme continues when the power supply is restored.

However, if the laundry has to be removed, the washing machine door can be opened as follows:

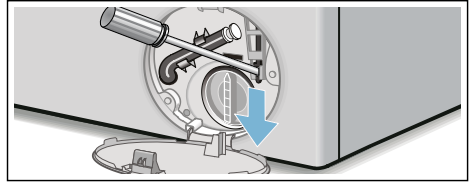

Warning **Risk of scalding!**

When you are washing at high temperatures, there is a risk of scalding if you come into contact with hot water and laundry.

If possible, leave it to cool down first.

Warning **Risk of injury!**

You may injure your hands if you reach into the drum while it is turning.

Do not reach into the drum when it is turning.

Wait until the drum has stopped turning.





Caution! **Water damage**

Any escaping water may cause water damage.

Do not open the door if water can be seen through the glass.



1. Switch off the appliance. Pull out the mains plug.
2. Drain the water. → *Page 28*
3. Pull the emergency release downwards with a tool and release. The door can then be opened.

Information on the display panel

Display	Cause/Remedy
- P - and 	The door is unlocked. It is possible to add laundry.
- P -	<ul style="list-style-type: none"> ■ The temperature is too high. Wait until the temperature drops. ■ The water level is too high. It is not possible to add laundry. Close the door immediately, if necessary. Press the ► button to continue the programme.
 flashes	<ul style="list-style-type: none"> ■ Laundry may be caught. Open and close the door again and press the ► button. ■ If necessary, push the door closed or remove some laundry and then push it closed again. ■ If necessary, switch the appliance off and on again; set the programme and make your individual settings; start the programme.
 lights up	<ul style="list-style-type: none"> ■ Turn on the tap fully, ■ Supply hose kinked/trapped, ■ The water pressure is too low. Clean the filter. → <i>Page 29</i>
E:18	<ul style="list-style-type: none"> ■ The drain pump is blocked. Clean the drain pump. → <i>Page 28</i> ■ The drain hose/drain pipe is blocked. Clean the drain hose at the siphon. → <i>Page 29</i>
E:23	There is water in the base trough, the appliance is leaking. Turn off the tap. Call customer services. → <i>Page 34</i>
	The childproof lock is activated – deactivate it. → <i>Page 22</i>
 lights up	Too much foam has been detected and an additional rinse cycle has been activated. Add less detergent to the next washing cycle with the same load.
Other displays	Switch off the appliance, wait for five seconds and then switch it on again. If the display appears again, call customer services. → <i>Page 34</i>

Faults and what to do about them.

Faults	Cause/Remedy
Water is leaking from the machine.	<ul style="list-style-type: none"> ■ Attach the drain hose correctly or replace it. ■ Tighten the screw fitting on the supply hose.
The machine is not filling with water.	<ul style="list-style-type: none"> ■ Have you pressed the ► button? ■ Is the tap turned on?
Detergent is not being dispensed.	<ul style="list-style-type: none"> ■ Could the filter be clogged? Clean the filter. → Page 29 ■ Is the supply hose kinked or trapped?
The door cannot be opened.	<ul style="list-style-type: none"> ■ The safety function is activated. Stop the programme? → Page 23 ■ Is ☐ selected (Rinse Stop = no final spin)? → Page 23 ■ Can the door only be opened by the emergency release? → Page 30
The programme will not start.	<ul style="list-style-type: none"> ■ Have you pressed the ► button or selected Finish in time? ■ Is the door closed? ■ Is the 🔒 childproof lock activated? Deactivate it. → Page 22
The drum briefly jerks or judders after the programme has started.	Not a fault – the internal motor test may cause the drum to jerk or judder briefly when the wash programme starts.
The water is not draining.	<ul style="list-style-type: none"> ■ Is ☐ selected (Rinse Stop = no final spin)? → Page 23 ■ Clean the drain pump. → Page 28 ■ Clean the drain pipe and/or the drain hose.
Water is not visible in the drum.	Not a fault – the water is below the visible area.
The spin result is not satisfactory. Laundry is wet/too damp.	<ul style="list-style-type: none"> ■ Not a fault – the unbalanced load detection system has interrupted the spin cycle because the laundry is unevenly distributed. Distribute small and large items of laundry evenly in the drum. ■ Is Easy Iron selected (depending on the model)? → Page 19 ■ Is the selected speed too low?
The spin cycle runs several times.	Not a fault – the unbalanced load detection system is adjusting an imbalance.
The programme is taking longer than usual.	<ul style="list-style-type: none"> ■ Not a fault – the unbalanced load detection system is adjusting an imbalance by repeatedly distributing the laundry. ■ Not a fault – the foam detection system is active – a rinse cycle has been switched on. → Page 22
The length of the programme changes during the wash cycle.	Not a fault – the programme sequence is optimised for the specific washing process. This may change the length of the programme shown in the display panel.
Residual water in the care-product compartment ☼.	<ul style="list-style-type: none"> ■ Not a fault – the effect of the care product is not affected. ■ Clean the insert if necessary. → Page 28

Faults	Cause/Remedy
Odours in the washing machine.	Run the Cottons 90 °C programme without laundry. Add washing powder or a detergent containing bleach. Note: . To prevent foaming, only use half of the amount of detergent recommended by the detergent manufacturer. Do not use detergents designed for woollens or delicates.
The  symbol lights up in the display panel. Foam may also be leaking from the detergent drawer.	Have you used too much detergent? Mix one tablespoon of fabric softener with 1/2 litre of water and pour it into compartment II (not suitable for outdoor clothing, sportswear or items stuffed with down). Use less detergent in the next washing cycle.
Loud noises, vibrations and machine "movement" during the spin cycle.	<ul style="list-style-type: none"> ■ Is the appliance aligned? Align the appliance. → <i>Page 43</i> ■ Are the appliance's feet fixed? Secure the appliance's feet. → <i>Page 43</i> ■ Have the transport braces been removed? Remove the transport braces. → <i>Page 39</i>
The display panel/ indicator lamps do not work while the appliance is running.	<ul style="list-style-type: none"> ■ Has there been a power failure? ■ Have the fuses blown? Reset/replace the fuses. ■ If the fault occurs repeatedly, call customer services.
There is detergent residue on the laundry.	<ul style="list-style-type: none"> ■ Some phosphate-free detergents contain water-insoluble residue. ■ Select Rinse or brush the laundry after washing.
- P - appears in the display panel when the cycle is paused.	<ul style="list-style-type: none"> ■ The water level is too high. It is not possible to add laundry. Close the door immediately, if necessary. ■ Press the ▶ button to continue the programme.
- P - and  appear in the display panel when the cycle is paused.	The door is unlocked. It is possible to add laundry.
If you cannot rectify a fault yourself (after switching the machine off and on again) or a repair is required: <ul style="list-style-type: none"> ■ Switch off the appliance and pull out the mains plug. ■ Turn off the tap and call customer services. 	



After-sales service

If you cannot rectify a fault yourself, contact customer services. → Cover page

We will always find an appropriate solution in order to avoid unnecessary visits by engineers.

Please give customer services the product number (E no.) and the production number (FD) of the appliance.

E-Nr. _____	FD _____
-------------	----------

E no. Product number
FD Production number

You can find this information
*depending on the model:

On the inside of the door*/in the opened service flap* and on the rear of the appliance.

Trust the expertise of the manufacturer.

Contact us for assistance. By doing so, you will ensure that the repairs are carried out by trained service personnel using genuine spare parts.



Consumption rates

Energy and water consumption, programme duration and residual moisture for the main washing programmes

(approximate values)

Programme	Load	Energy consumption**	Water consumption**	Programme duration**
Cottons 20 °C	8 kg	0,25 kWh	87 l	2 ¾ h
Cottons 40 °C	8 kg	1,03 kWh	87 l	3 h
Cottons 60 °C	8 kg	0,96 kWh	87 l	2 ¾ h
Cottons 60 °C + ecoPerfect  *	8 kg	1,06 kWh	55 l	4 h
Cottons 90 °C	8 kg	2,11 kWh	97 l	2 ¾ h
Synthetics 40 °C	4 kg	0,71 kWh	64 l	2 h
Mix 40 °C	4 kg	0,60 kWh	45 l	1 ¼ h
Delicate / Silk 30 °C	2 kg	0,19 kWh	37 l	¾ h
Wool 30 °C	2 kg	0,19 kWh	41 l	¾ h

Programme	Approximate information on the residual moisture***			
	WM16... Max. 1600 rpm	WM14... Max. 1400 rpm	WM12... Max. 1200 rpm	WM10... Max. 1000 rpm
Cottons	44 %	48 %	53 %	62 %
Synthetics	40 %	40 %	40 %	40 %
Delicate / Silk	30 %	30 %	30 %	30 %
Wool / Gentle handwash	45 %	45 %	45 %	45 %

* Program setting for testing and energy labelling in accordance with European standard 60456:2005 with cold water (15 °C).

** Observed values may deviate from the indicated values due to influence of water pressure, hardness and inlet temperature, ambient temperature, type, amount and soiling of laundry, detergent used, fluctuations in power supply and selected additional functions.

*** Information on residual moisture based on programme-dependent spin-speed limit and maximum loads.



Technical data

Dimensions:

850 x 600 x 590 mm

(height x width x depth)

Weight:

70 - 85 kg (depending on model)

Mains connection:

Mains voltage 220 - 240 V, 50 Hz

Nominal current 10 A

Nominal power 1900 – 2300 W

Water pressure:

100 - 1000 kPa (1 - 10 bar)

Power consumption when switched off:

0,12 W

Power consumption when left on:

0,43 W



Positioning and connecting

Included with the appliance

Note: Check the machine for transport damage. Never use a damaged machine. If you have any complaints, contact the dealer from whom you purchased the appliance or our customer services. → Page 34

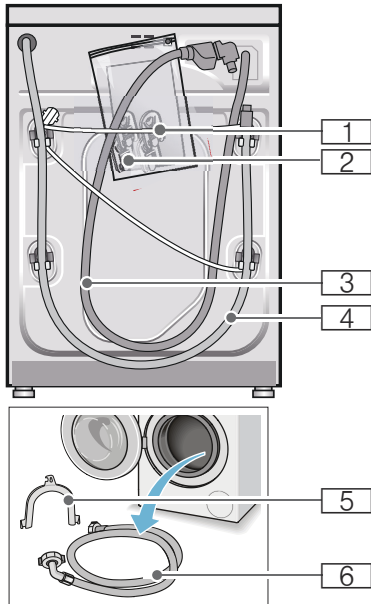

- 1 Mains cable
 - 2 Bag:
 - Installation and operating instructions
 - Customer services location directory*
 - Warranty*
 - Cover caps for openings after the transport braces have been removed
 - Adaptor with sealing washer from 21 mm = 1/2" to 26.4 mm = 3/4" *
 - 3 Water supply hose on Aqua-Stop models
 - 4 Water drain hose
 - 5 Elbow for securing the water drain hose*
 - 6 Water supply hose on standard/ Aqua-Secure models
- * depending on the model

In addition, a hose clamp (24 - 40 mm diameter, available from specialist dealers) is required to connect the water drain hose to a siphon.

Useful tools

- Spirit level for aligning
- Spanner with:
 - WAF13 for loosening the transport braces, and
 - WAF17 for aligning the appliance feet

Safety instructions

Warning **Risk of injury!**

- The washing machine is very heavy. Be careful when lifting/transporting the washing machine.
- When the washing machine is lifted by its protruding parts (e.g. the washing machine door), the components may break off and cause injuries. Do not lift the washing machine by protruding parts.
- If the hose and mains cables are not routed properly, there is a risk of tripping and injury. Lay hoses and cables in such a way that there is no risk of tripping.

Caution!

Damage to the appliance

Frozen hoses may rip/burst. Do not install the washing machine in areas exposed to frost or outdoors.

Caution!

Water damage

The connection points for the water supply hose and water drain hose are under high water pressure. To prevent leaks and water damage, you must follow the instructions in this section.

Notes

- In addition to the safety information listed here, the local water and electricity supplier may have special requirements.
- If in doubt, have the appliance connected by a specialist.

Installation surface

Note: The washing machine be stable so that it does not move around.

- The installation surface must be firm and level.
- Soft floors/floor coverings are not suitable.

Installation on a base or a wooden joist floor

Caution!

Damage to the appliance

The washing machine may "wander" and tip/topple from the base when spinning.

The feet of the appliance must be secured with holding brackets.

Order no. WMZ 2200, WX 9756, Z 7080X0

Note: On wooden joist floors, install the washing machine:

- In a corner, if possible,
- On a water-resistant wooden board (min. 30 mm thick) which is screwed tightly to the floor.

Installation on a platform with drawer

Platform order no.: WMZ 20490, WZ 20490, WZ 20510, WZ 20520

Installing the appliance in a kitchenette

⚠ Warning **Danger of death!**

There is a risk of electric shock if you touch live components.
Do not remove the appliance covering plate.

Notes

- Recess width of 60 cm required.
- Only install the washing machine underneath a continuous worktop that is securely connected to adjacent cabinets.

Removing the transport locks

Caution! **Damage to the appliance**

- The machine is secured for transportation using transport locks. If the transport locks are not removed, the drum, for example, may become damaged when the machine is operated. Before using the appliance for the first time, make sure that you completely remove all four transport locks. Keep the locks in a safe place.
- To prevent transport damage from occurring if the appliance is moved at a later date, you must refit the transport locks before transporting the appliance.

Note: Keep the screws and sleeves in a safe place.

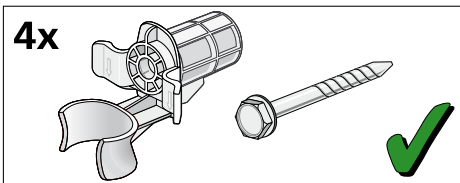

1. Take the hoses out of the holders.

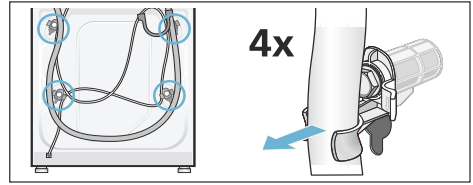

2. Unscrew and remove all four transportation securing bolts with a wrench (WAF 13). Remove the sleeves. Remove the mains cable from the holders.

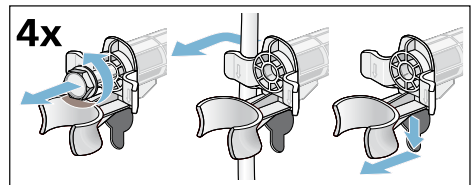

3. Insert the covers. Lock the covers firmly in place by applying pressure to the snap-in hooks.

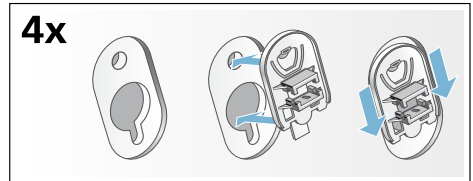

Hose and cable lengths

■ Left-hand connection

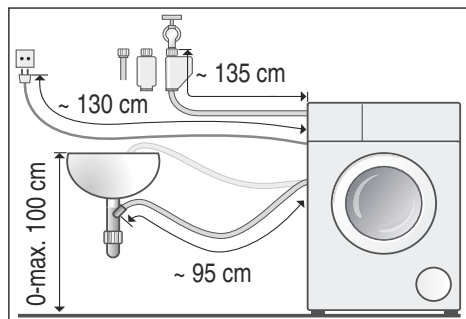

■ Right-hand connection

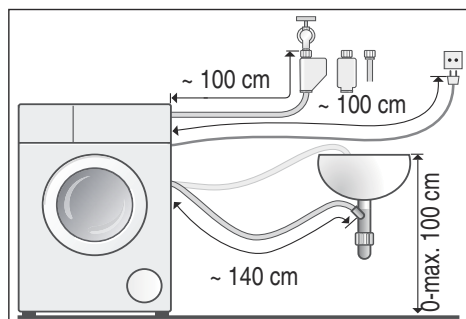

Tip: The following are available from specialist dealers/customer services:

- Extension for Aqua-Stop and cold water supply hose (approx. 2.50 m); order no. WM Z2380, WZ 10130, CZ 11350, Z 7070X0
- A longer supply hose (approx. 2.20 m) for standard models; individual component number for customer services: 00353925

Water inlet

Warning **Danger of death!**

There is a risk of electric shock if you touch live components.

Do not immerse the Aqua-Stop safety valve in water (it contains an electric valve).

Notes

- Only operate the washing machine using cold mains water.
- Do not connect the machine to the mixer tap of an unpressurised hot-water boiler.
- Do not use a used supply hose. Only use the supply hose supplied or one that was purchased from an authorised specialist retailer.
- Do not kink or squash the water supply hose.
- Do not alter (shorten, cut through) the water supply hose (otherwise its strength is no longer guaranteed).
- Only tighten the screw connections by hand. If the screw connections are tightened too much with a tool (pliers), the thread may become damaged.
- When connecting to a 21 mm = 1/2" tap, first fit an adapter* with a sealing washer from 21 mm = 1/2" to 26.4 mm = 3/4".
*supplied depending on the model

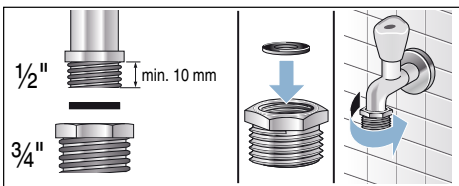

Optimum water pressure in the supply network

At least 100 kPa (1 bar)

Maximum 1000 kPa (10 bar)

When the tap is open, the water flow rate is at least 8 l/min.

If the water pressure is higher than this, a pressure-reducing valve must be installed.

Connection

Connect the water supply hose to the tap (26.4 mm = 3/4") and to the appliance (not necessary for Aqua-Stop models as this is permanently installed):

■ Model: **Standard**

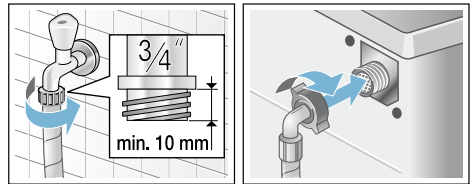

■ Model: **Aqua-Secure**

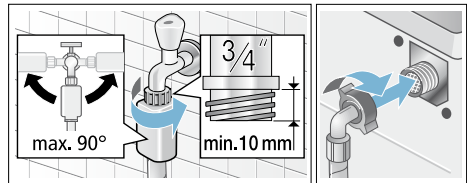

■ Model: **Aqua-Stop**

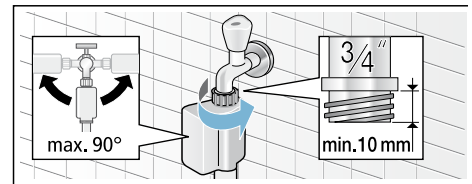

Note: Turn on the tap carefully, checking the leak tightness of the connection points. The screw connection is under mains water pressure.

Water outlet

Warning **Risk of scalding!**

When you are washing at high temperatures, there is a risk of scalding if you come into contact with hot water (e.g. when draining hot water into a washbasin).

Do not reach into the hot water.

Caution! **Water damage**

If the drain hose slips out of the washbasin or the connection point during draining due to high water pressure, any escaping water may cause water damage.

Secure the drain hose so that it cannot slip out.

Caution! **Damage to the appliance/fabrics**

If the end of the drain hose is immersed in the drained water, water may be sucked back into the appliance and may damage the appliance/fabrics. Make sure that:

- The plug does not block drainage from the washbasin.
- The end of the drain hose is not immersed in the drained water.
- The water drains away quickly enough.

Note: Do not kink the water drain hose or put strain on it lengthways.

Connection

■ **Drainage into a washbasin**

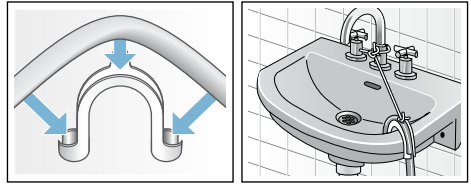

■ **Drainage into a siphon**

The connection point must be secured using a hose clamp with a diameter of 24 - 40 mm (available from specialist dealers).

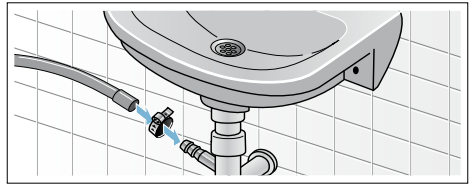

■ **Drainage into a plastic pipe with rubber bushing or into a drainage pit**

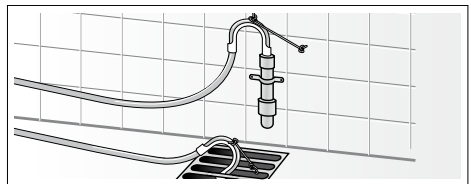

Levelling

Align the appliance using a spirit level.

Incorrect alignment may result in loud noises, vibrations and machine "movement".

1. Loosen the lock nuts using a WAF17 spanner, by turning it in a clockwise direction.
2. Check the alignment of the washing machine with a spirit level, and adjust it if necessary. Change the height by turning the appliance feet. All four appliance feet must stand firmly on the ground.
3. The lock nuts on all four appliance feet must be screwed tightly against the housing using a suitable WAF17 spanner. In doing so, hold the foot tight and do not adjust its height.



Electrical connection

Warning **Danger of death!**

There is a risk of electric shock if you touch live components.

- Never touch or hold the mains plug with wet hands.
- Only pull out the mains cable by the plug and never by the cable, as this could damage it.
- Never unplug the mains plug during operation.

Observe the following information and ensure that:

Notes

- The mains voltage and voltage indicated on the washing machine (rating plate) are the same. The connected load and fuse required are specified on the rating plate.
- The mains plug fits the socket.
- The cable cross-section is adequate.
- The mains cable is only replaced by a qualified electrician (if this is necessary). Replacement mains cables are available from the after-sales service.
- No multiple plugs/couplings or extension cables are used.
- If an earth-leakage circuit breaker is used, only a type which displays this symbol is used: . Only this symbol guarantees compliance with the currently applicable regulations.
- The mains plug can be accessed at all times.
- The mains cable is not bent, squashed, modified, cut through, or in contact with heat sources.

Grounding Instructions

Warning **Danger of death!**

Improper connection of the ground may result in electric shock. Have the appliance checked by a qualified technician or licensed electrician if you are in doubt as to whether the washing machine has been properly grounded.

This appliance must be grounded. In the event of malfunction or breakdown, grounding will reduce the risk of electric shock by providing a path of least resistance for the electric current. This appliance is equipped with a cord that has an equipment grounding conductor and a grounding plug. The plug must be plugged into an appropriate outlet that is properly installed and grounded in accordance with local codes and ordinances. To ground the appliance use a 3 pin plug and properly grounded socket of 16 A rating.

Notes

- Do not modify the plug provided with the appliance. If the plug will not fit into outlet have a properly grounded outlet installed by qualified electrician. Do not cut, remove or bypass the grounding prong on the washing machine power cord plug.
- The wiring for the electrical outlet circuit must be sufficient to meet the appliance requirements. Use of Ground Fault Circuit Interrupter (GFCI) is recommended.
- Do not use the machine with an extension box, extension cord, spike busters etc., as this may lead to improper grounding conditions.

Before washing for the first time

The washing machine was thoroughly tested before leaving the factory. To remove any water that may be left over from the test, run the first wash cycle **without** any laundry.

Notes

- The washing machine **must be correctly installed and connected.**
From → *Page 37*
- Never use a machine if it is damaged. Inform the after-sales service.

Preparatory work:

1. Check the machine.
2. Remove the protective film from the control panel.
3. Plug in the mains plug.
4. Turn on the tap.

Running the programme without laundry:

1. Switch on the appliance.
2. Close the door (do not load any laundry).
3. Set the **Cottons 90 °C** programme.
4. Open the detergent drawer.
5. Pour approximately 1 litre of water into compartment **II**.
6. Pour standard washing powder into compartment **II**.

Note: To prevent foaming, only use half the amount of detergent recommended by the detergent manufacturer. Do not use detergents intended for woollens or delicates.

7. Close the detergent drawer.
8. Press the ►|| button.
9. Switch off the appliance at the end of the programme.

Your washing machine is now ready to use.

Transportation

E.g. when moving house

Preparatory work:

1. Turn off the tap.
2. Reduce the water pressure in the supply hose: → *Page 29*; Cleaning and maintenance – filter in the water supply blocked
3. Disconnect the washing machine from the mains.
4. Drain the remaining water: → *Page 28*; cleaning and maintenance – the drain pump is blocked, emergency draining
5. Remove the hoses.

Fitting the transportation securing means:

1. Remove the covers and keep them in a safe place.
If required, use a screwdriver.

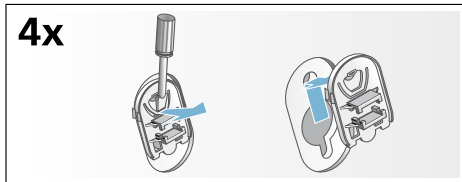

2. Insert all four sleeves.
Clip the mains cable securely in the holders. Insert the transportation securing bolts and tighten them with a wrench (WAF 13).

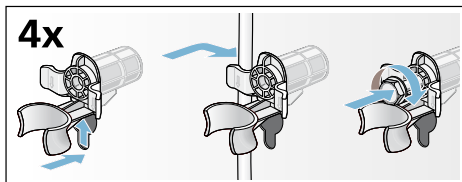

Before switching on the appliance again:

Notes

- The transport braces **must** be removed.
- Pour approx. 1 litre of water into compartment **II**, select the **Drain** programme and start.
This will prevent detergent from flowing unused into the drain during the next wash.



Aqua-Stop warranty

Only for appliances with Aqua-Stop

In addition to warranty claims against the vendor based on the purchase agreement and to our appliance warranty, we will provide compensation under the following conditions:

1. If water damage is caused due to a fault in our Aqua-Stop system, we will compensate domestic customers for the damage caused.
2. The liability guarantee is valid for the service life of the appliance.
3. It is a prerequisite of all warranty claims that the appliance with Aqua-Stop must have been installed and connected correctly in accordance with our instructions; this also includes a correctly fitted Aqua-Stop extension (genuine accessories). Our warranty does not cover defective feed lines or fittings leading to the Aqua-Stop connection at the tap.
4. Appliances with Aqua-Stop do not need to be supervised during operation, nor secured afterwards by turning off the tap.
The tap only needs to be turned off if you are away from home for a long period, e.g. for several weeks' holiday.

Repair order and advice in the event of faults

GB 0344 892 8999 (Calls charged at local or mobile rate.)

IE 01450 2655 (0.03 € per minute at peak. Off peak 0.0088 € per minute.)

You can find the contact information for all countries in the attached after-sales service directory.

BSH Hausgeräte GmbH

Carl-Wery-Straße 34

81739 München

GERMANY

siemens-home.com

Manufactured by BSH Hausgeräte GmbH under Trademark License of Siemens AG



9001240703 (9608)