

SIEMENS



Gaskochfeld

Table de cuisson gaz

Piano di cottura a gas

Gaskookplaat

EP9A.Q....

siemens-home.com/welcome

[de]Gebrauchsanleitung	3
[fr] Notice d'utilisation	13
[it] Istruzioni per l'uso	23
[nl] Gebruiksaanwijzing	33

Register
your
product
online

EP9A.QB9..

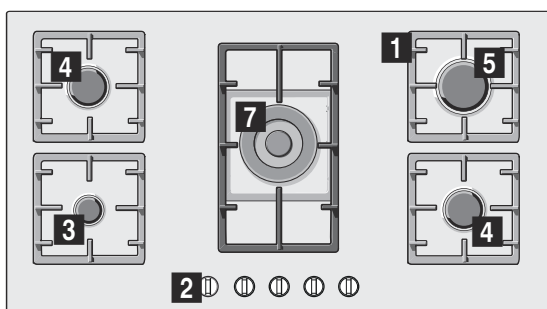

-
- | | |
|--------------------------------------|-------------------------------------------|
| 1 Rost | 4 Normalbrenner mit bis zu 1,75 kW |
| 2 Bedienknebel | 5 Schnellbrenner mit bis 3 kW |
| 3 Sparbrenner mit bis zu 1 kW | 7 Wokbrenner mit bis zu 4 kW |
-
- | | |
|--------------------------------------|----------------------------------------------|
| 1 Grilles | 4 Brûleur standard de 1,75 kW maximum |
| 2 Boutons de commande | 5 Brûleur rapide de 3 kW maximum |
| 3 Brûleur éco de 1 kW maximum | 7 Brûleur pour wok avec jusqu'à 4 kW |
-
- | | |
|-----------------------------------------|---------------------------------------------|
| 1 Griglie | 4 Bruciatore standard fino a 1,75 kW |
| 2 Manopole | 5 Bruciatore rapido fino a 3 kW |
| 3 Bruciatore piccolo fino a 1 kW | 7 Bruciatore per wok fino a 4 kW |
-
- | | |
|-------------------------------|--------------------------------------|
| 1 Roosters | 4 Halfsnelbrander tot 1,75 kW |
| 2 Knoppen | 5 Snelbrander tot 3 kW |
| 3 Hulpbrander tot 1 kW | 7 Wokbrander met max. 4 kW |

Inhaltsverzeichnis

	Bestimmungsgemäßer Gebrauch	3
	Wichtige Sicherheitshinweise	4
	Gerät kennen lernen	5
	Bedienelemente und Brenner.....	5
	Zubehör	6
	Gasbrenner	6
	Manuelles Einschalten	6
	Automatische Zündung	6
	Sicherheitssystem	6
	Ausschalten eines Brenners.....	6
	Warnhinweise.....	7
	Tabellen und Tipps	7
	Geeignete Kochgefäße.....	7
	Hinweise bei der Benutzung.....	7
	Gartabelle.....	7
	Reinigen und warten	10
	Reinigung.....	10
	Pflege.....	10
	Störungen, was tun?	11
	Kundendienst	12
	Garantiebedingungen.....	12
	Umweltschutz	12
	Umweltgerecht entsorgen	12

Weitere Informationen zu Produkten, Zubehör, Ersatzteilen und Services finden Sie im Internet: www.siemens-home.com und Online-Shop: www.siemens-eshop.com

Für Produktinformationen sowie Anwendungs- und Bedienungsfragen berät Sie unsere **Siemens Info Line** unter **Tel.: 089 21 751 751*** (Mo-Fr: 8.00-18.00 Uhr erreichbar) oder unter **Siemens-info-line@bshg.com**
*) Nur für Deutschland gültig.

Bestimmungsgemäßer Gebrauch

Lesen Sie diese Gebrauchsanweisung aufmerksam durch. Nur so können Sie Ihr Gerät effektiv und sicher benutzen. Bewahren Sie die Installations- und Gebrauchsanweisungen gut auf und geben Sie sie an einen eventuellen Nachbesitzer des Geräts weiter.

Der Hersteller ist jeglicher Verantwortung enthoben, wenn die Bestimmungen dieses Handbuchs nicht eingehalten werden.

Die in dieser Anleitung enthaltenen Abbildungen sind orientativ.

Belassen Sie das Gerät bis zum Einbau in der Schutzhülle. Falls Sie einen Schaden am Gerät feststellen, schließen Sie es nicht an. Rufen Sie unseren Kundendienst.

Dieses Gerät entspricht Klasse 3 gemäß DIN EN 30-1-1 für Gasgeräte: Einbaugeräte.

Vor dem Einbau Ihres neuen Kochfelds stellen Sie sicher, dass bei der Installation der Einbauanleitung gefolgt wird.

Dieses Gerät darf nicht auf Yachten oder in Wohnwagen eingebaut werden.

Dieses Gerät darf nur an einem ausreichend belüfteten Ort genutzt werden.

Dieses Gerät ist nicht für den Betrieb mit einer externen Zeitschaltuhr oder einer Fernsteuerung bestimmt.

Alle Installations-, Anschluss-, Regelungs- und Umstellungsarbeiten auf eine andere Gasart müssen von einem autorisierten Fachmann und unter Beachtung der jeweils anwendbaren Regelungen und gesetzlichen Vorgaben sowie der Vorschriften der örtlichen Strom- und Gasversorger vorgenommen werden. Besondere Aufmerksamkeit ist den für die Belüftung geltenden Bestimmungen und Richtlinien zuzuwenden.

Dieses Gerät ist werkseitig auf die auf dem Typenschild angegebene Gasart eingestellt. Informationen zur Umstellung auf eine andere Gasart finden Sie in der Einbauanleitung. Für Umstellungsarbeiten auf eine andere Gasart empfehlen wir, den Kundendienst zu rufen.

Dieses Gerät wurde ausschließlich für die Verwendung in Privathaushalten entworfen; eine kommerzielle oder gewerbliche Nutzung ist nicht gestattet. Benutzen Sie das Gerät nur zum Kochen, niemals als Heizgerät. Die Garantie gilt nur dann, wenn das Gerät ausschließlich für seinen vorgesehenen Zweck genutzt wird.

Dieses Gerät ist für eine Nutzung bis zu einer Höhe von maximal 2000 Metern über dem Meeresspiegel bestimmt.

Während des Betriebs, sollte das Gerät nicht unbeaufsichtigt gelassen werden.

Verwenden Sie keine Abdeckungen oder Kindersicherungen, die nicht vom Hersteller des Kochfelds empfohlen werden. Es kann zu Unfällen kommen, beispielsweise durch Überhitzung, Entflammung oder Ablösung von Materialteilen.

Dieses Gerät kann von Kindern ab 8 Jahren und Personen mit reduzierten physischen, sensorischen oder mentalen Fähigkeiten oder Mangel an Erfahrung oder Wissen benutzt werden, wenn sie von einer Person, die für ihre Sicherheit verantwortlich ist, beaufsichtigt oder von ihr bezüglich des sicheren Gebrauchs des Gerätes unterwiesen wurden und sie die daraus resultierenden Gefahren verstanden haben.

Kinder dürfen nicht mit dem Gerät spielen. Reinigung und Benutzer-Wartung dürfen nicht durch Kinder durchgeführt werden, es sei denn, sie sind 8 Jahre und älter und werden beaufsichtigt.

Kinder jünger als 8 Jahre vom Gerät und der Anschlussleitung fernhalten.

Wichtige Sicherheitshinweise

Warnung – Gefahr der Verpuffung!

Bei Ansammlung von unverbranntem Gas in geschlossenen Räumen besteht Verpuffungsgefahr. Das Gerät nicht der Zugluft aussetzen. Die Brenner können sonst ausgehen. Lesen Sie die Warnhinweise bezüglich der Funktionsweise der Gasbrenner aufmerksam durch.

Warnung – Vergiftungsgefahr!

Die Benutzung eines Gaskochgeräts erzeugt in dem Raum, in dem es betrieben wird, Wärme, Feuchtigkeit und Verbrennungsprodukte. Stellen Sie sicher, dass die Küche gut durchlüftet ist, vor allem wenn das Kochfeld in Betrieb ist: halten Sie die natürlichen Belüftungsöffnungen frei oder installieren Sie eine mechanische Belüftung (Abzugshaube). Ein langer und dauerhafter Betrieb des Geräts kann eine zusätzliche oder effizientere Belüftung erfordern: öffnen Sie ein Fenster oder erhöhen Sie die Leistung der Abzugshaube.

Warnung – Verbrennungsgefahr!

- Kochstellen und deren Umgebung werden sehr heiß. Berühren Sie niemals heiße Oberflächen. Halten Sie Kinder unter 8 Jahren fern.
- Wenn die Flüssiggasflasche nicht senkrecht steht, kann flüssiges Propan/Butan in das Gerät gelangen. Dabei können heftige Stichflammen an den Brennern austreten. Bauteile können beschädigt und mit der Zeit undicht werden, so dass unkontrolliert Gas austritt. Beides kann zu Verbrennungen führen. Flüssiggasflaschen immer in senkrechter Position verwenden.

Warnung – Brandgefahr!

- Die Kochstellen werden sehr heiß. Brennbare Gegenstände niemals auf das Kochfeld stellen. Keine Gegenstände auf dem Kochfeld abstellen.
- Lagern Sie keine ätzenden chemischen Reinigungsmittel oder Produkte, Dampfreiniger, brennbare Materialien oder andere Produkte, die keine Lebensmittel sind, unter diesem Haushaltsgerät bzw. benutzen Sie diese nicht in unmittelbarer Nähe.

- Überhitztes Fett oder Öl ist leicht entzündlich. Entfernen Sie sich nicht, wenn Sie Fett oder Öl erhitzen. Falls sich Fett oder Öl entzündet, löschen Sie das Feuer nicht mit Wasser. Decken Sie das Kochgefäß zum Erstickten der Flamme mit einem Deckel ab und schalten Sie die Kochstelle aus.

⚠ Warnung – Verletzungsgefahr!

- Sprünge oder Brüche in der Glasplatte sind gefährlich. Alle Brenner und jedes elektrische Heizelement unverzüglich ausschalten. Netzstecker ziehen oder Sicherung im Sicherungskasten ausschalten. Gaszufuhr schließen. Die Oberfläche des Geräts nicht berühren. Nie ein defektes Gerät einschalten. Kundendienst rufen.
- Starke Temperaturschwankungen können zu einer Beschädigung der Glasscheibe führen. Vermeiden Sie bei der Benutzung des Kochfelds Luftzüge und das Verschütten kalter Flüssigkeiten.
- Kochgefäße, die beschädigt sind, die nicht die richtige Größe aufweisen, deren Rand über das Kochfeld hinausragt oder die schlecht aufgestellt sind, können schwere Schäden verursachen. Beachten Sie die Tipps und Warnhinweise zu den Kochgefäßen.
- Beim Auftreten einer Störung stellen Sie die Gas- und Stromzufuhr des Geräts ab. Für Reparaturarbeiten rufen Sie bitte unseren Kundendienst.
- Nehmen Sie keine Arbeiten im Geräteinneren vor. Gegebenenfalls rufen Sie bitte unseren Kundendienst.
- Falls sich ein Bedienknebel nicht drehen lässt, versuchen Sie es nicht gewaltsam. Rufen Sie unverzüglich den Kundendienst, damit er ihn repariert oder austauscht.

⚠ Warnung – Stromschlaggefahr!

- Benutzen Sie keine Dampfreiniger zur Reinigung des Geräts.
- Sprünge oder Brüche in der Glasplatte können Stromschläge verursachen. Sicherung im Sicherungskasten ausschalten. Kundendienst rufen.

Gerät kennen lernen



In der Modellübersicht finden Sie Ihr Gerät mit den Brennerleistungen. → Seite 2

Bedienelemente und Brenner

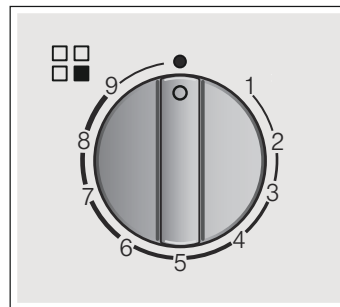
An jedem Bedienknebel ist der zugehörige Brenner gekennzeichnet. Mit den Bedienknäbeln können Sie, entsprechend der verschiedenen Positionen, die jeweils benötigte Leistung zwischen den Maximal- und Minimalwerten einstellen. Versuchen Sie nie, von Position 0 direkt auf Position 1 oder von Position 1 auf Position 0 zu wechseln.



Anzeigen

	Vom Bedienknebel gesteuerter Brenner
	Ausgeschalteter Brenner
9	Höchste Leistungsstufe und elektrische Zündung
1	Niedrigste Leistungsstufe

Für einen korrekten Betrieb des Geräts müssen sowohl die Roste als auch alle Brennerteile richtig aufliegen. Die Brennerdeckel nicht vertauschen.

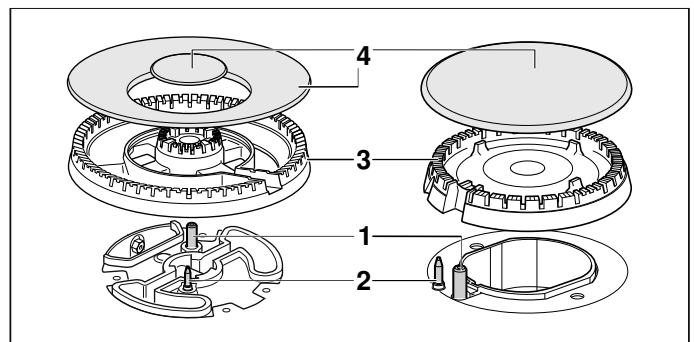

Elemente

1	Zündkerze
2	Thermoelement
3	Brennerkelch
4	Brennerdeckel

Zubehör

Je nach Modell sind beim Kochfeld folgende Zubehörteile inbegriffen. Diese sind auch über den Kundendienst erhältlich.

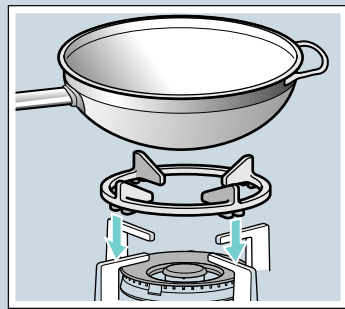

Wok-Aufsatz

Nur für den Gebrauch von Kochgefäßen mit gewölbtem Boden, Bratplatten und Tonkasserollen auf Wok-Brennern.

Um die Lebensdauer des Gerätes zu verlängern, wird die Verwendung des Wok-Aufsatzes empfohlen.

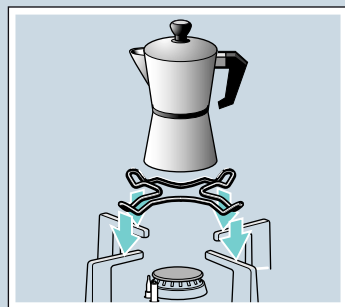

Aufsatzrost Kaffeekocher

Nur für den Gebrauch von Kochgeschirr mit weniger als 12 cm Bodendurchmesser auf dem kleinsten Brenner.

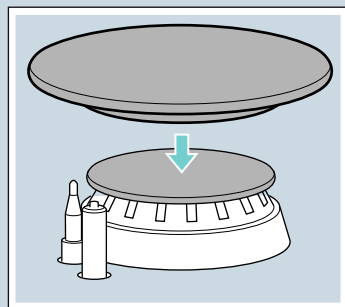

Simmer Cap

Deckel, der ausschließlich dem Kochen mit minimaler Leistung dient. Für die Benutzung muss der Deckel Simmer Cap auf dem Deckel des Sparbrenners angebracht werden.

Teilenummer

HZ298107 Wok-Aufsatz: Gusseisen (4-5 kW)

HZ298114 Aufsatzrost Kaffeekocher

HZ211310 Simmer Cap

Der Hersteller übernimmt für die fehlende oder fehlerhafte Verwendung dieser Zubehörteile keine Verantwortung.

Gasbrenner

Manuelles Einschalten

1. Drücken Sie den Bedienknebel des ausgewählten Brenners und drehen Sie ihn nach links, bis zur höchsten Leistungsstufe.
2. Halten Sie einen Anzünder oder eine Flamme (Feuerzeug, Streichholz usw.) an den Brenner.

Automatische Zündung

Wenn Ihr Kochfeld über eine automatische Zündung verfügt (Zündkerzen):

1. Drücken Sie den Bedienknebel des ausgewählten Brenners und drehen Sie ihn nach links, bis zur höchsten Leistungsstufe. Während Sie den Bedienknebel gedrückt halten, werden an allen Brennern Funken geschlagen. Der Brenner zündet.
2. Lassen Sie den Bedienknebel los.
3. Drehen Sie den Bedienknebel in die gewünschte Position.

Erfolgt keine Zündung, schalten Sie den Brenner aus und wiederholen Sie die vorher beschriebenen Schritte. Halten Sie dieses Mal den Bedienknebel länger gedrückt (bis zu 10 Sekunden).

⚠ Warnung – Verpuffungsgefahr!

Wenn der Brenner nach 15 Sekunden nicht zündet, schalten Sie den Bedienknebel aus und öffnen Sie die Tür oder das Fenster des Raumes. Warten Sie mindestens eine Minute, bevor Sie den Brenner erneut zünden.

Hinweis: Achten Sie auf höchste Sauberkeit. Sind die Zündkerzen verschmutzt, kann es zu einer fehlerhaften Zündung kommen. Reinigen Sie die Zündkerzen regelmäßig mit einer kleinen, nicht metallischen Bürste. Achten Sie darauf, dass auf die Zündkerzen keine heftigen Stöße ausgeübt werden.

Sicherheitssystem

Ihr Kochfeld verfügt über ein Sicherheitssystem (Thermoelement), das den Gasaustritt verhindert, wenn die Brenner versehentlich ausgehen.

Um sicherzugehen, dass diese Vorrichtung aktiv ist:

1. Entzünden Sie den Brenner wie gewohnt.
2. Halten Sie den Bedienknebel weiterhin während 4 Sekunden nach dem Anzünden der Flamme fest gedrückt.

Ausschalten eines Brenners

Drehen Sie den betreffenden Bedienknebel nach rechts, bis die Position 0 erreicht ist.

Einige Sekunden nach Abschalten des Brenners ist ein dumpfes Geräusch zu hören. Dies ist normal und bedeutet, dass das Sicherheitssystem deaktiviert wurde.

Warnhinweise

Ein leises Summen während des Betriebs der Brenner ist normal.

Während des ersten Gebrauchs ist es normal, dass Gerüche frei werden. Das stellt kein Risiko bzw. keinen Defekt dar. Die Gerüche verschwinden mit der Zeit.

Eine orangefarbene Flamme ist normal. Sie entsteht durch in der Luft befindlichen Staub, übergelaufene Flüssigkeiten usw.

Wenn die Flamme des Brenners versehentlich ausgeht, drehen Sie den Bedienknebel des Brenners auf Aus und zünden Sie den Brenner für mindestens eine Minute nicht erneut an.

Tabellen und Tipps

Geeignete Kochgefäße

Brenner	Minstdurchmesser des Gefäßes	Höchst Durchmesser des Gefäßes
Wok-Brenner	22 cm	30 cm
Schnellbrenner	22 cm	26 cm
Normalbrenner	14 cm	20 cm
Sparbrenner	12 cm	16 cm

Achtung!

Um Schäden am Gerät zu vermeiden, ist beim Kochen mit Bratplatten oder Tonkasserollen immer der Wok-Aufsatz zu verwenden. → Seite 6

Hinweise bei der Benutzung

Die folgenden Hinweise helfen Ihnen, Energie zu sparen und Schäden an Kochgefäßen zu vermeiden:

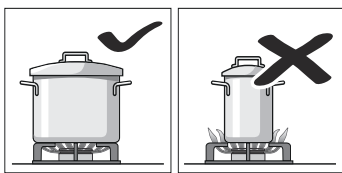

Verwenden Sie Kochgefäße geeigneter Größe für den jeweiligen Brenner. Benutzen Sie keine kleinen Kochgefäße auf den großen Brennern. Die Flamme sollte die Seiten der Kochgefäße nicht berühren.

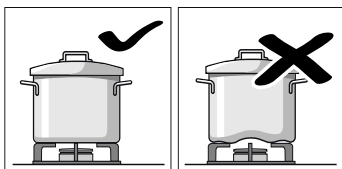

Benutzen Sie keine verformten Kochgefäße, die auf dem Kochfeld nicht stabil stehen. Die Gefäße können umkippen. Benutzen Sie nur Kochgefäße mit flachem und dickem Boden.

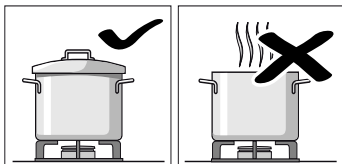

Kochen Sie nicht ohne Deckel oder wenn der Deckel verschoben ist. Ein großer Teil der Energie wird verschwendet.

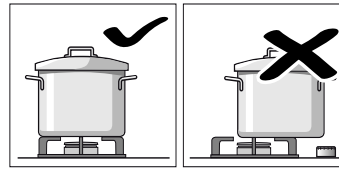

Stellen Sie das Kochgefäß mittig über den Brenner, sonst kann das Gefäß umkippen.

Stellen Sie große Töpfe nicht auf die Brenner in der Nähe der Armaturen. Diese könnten überhitzt und dadurch beschädigt werden.

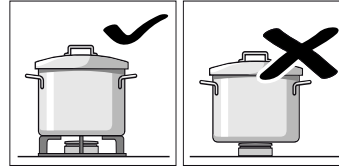

Stellen Sie die Töpfe auf die Roste, niemals direkt auf die Brenner.

Vergewissern Sie sich vor der Benutzung, dass die Topfrost und die Deckel der Gasbrenner korrekt aufliegen.

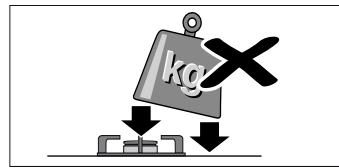

Hantieren Sie vorsichtig mit den Gefäßen, die auf dem Kochfeld stehen. Schlagen Sie nicht auf das Kochfeld und stellen Sie keine schweren Gewichte darauf.

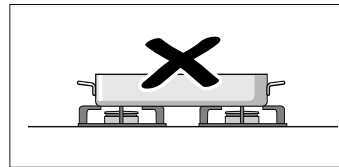

Benutzen Sie nicht zwei Brenner oder Wärmequellen für nur ein Kochgefäß.

Vermeiden Sie den Gebrauch von Bratpfannen, Tontöpfen usw. über einen längeren Zeitraum bei maximaler Leistung.

Gartabelle



Die folgende Tabelle enthält die optimalen Kochstufen und Garzeiten für verschiedene Gerichte. Die Angaben sind Referenzwerte für vier Personen.

Die Garzeiten und Kochstufen sind von Art, Gewicht und Qualität der Speisen sowie vom Material des Kochgeschirrs abhängig. Deshalb sind Abweichungen möglich.







Stets entsprechend großes Geschirr verwenden und mittig auf dem Brenner positionieren. Sehen Sie sich die Informationen zum Durchmesser des Kochgeschirrs an. → "Geeignete Kochgefäße"

Informationen zur Tabelle

Die Zubereitung jedes Gerichts setzt sich aus einem oder zwei Schritten zusammen. Jeder Schritt enthält Informationen über:

-  Garmethode
-  Kochstufe
-  Dauer in Minuten







In der Tabelle angegebene Garmethoden

-  Aufkochen
-  Weiterkochen
-  Druck im Schnellkochtopf aufbauen
-  Druck im Schnellkochtopf halten
-  Stark anbraten
-  Leicht anbraten
-  Schmelzen, zerlassen
- * Ohne Deckel
- ** Kontinuierlich rühren

Hinweis: Diese Symbole finden Sie nicht auf dem Gerät. Sie dienen als Orientierung für die verschiedenen Garmethoden.

In der Tabelle finden Sie Angaben für die Zubereitung von Gerichten auf unterschiedlichen Brennern. Die empfohlene Option ist der erste Brenner. In der Modellübersicht werden alle Brenner des Kochfelds beschrieben. → Seite 2

Beispiel:













Gericht Brenner	Gesamtzeit in Min.	Schritt 1	Schritt 2
Suppen, Cremesuppen			
Fischsuppe			
Schnell	12-17	 8 7-9	 1 5-8
Normal	17-22	 8 11-13	 1 6-9
Wok	10-15	 9 6-8	 4 4-7





















































Dieses Beispiel zeigt die Zubereitung von Fischsuppe mithilfe des Schnellbrenners, Normalbrenners und Wokbrenners.



















































Mit dem Schnellbrenner (empfohlene Option) beträgt die Gesamtgarzeit zwischen 12 und 17 Minuten.











































- Schritt 1: Aufkochen. Kochstufe 8 für 7-9 Minuten verwenden.
- Schritt 2: Weiterkochen. Auf Kochstufe 1 wechseln für 5-8 Minuten.



























Wenn Sie einen der anderen vorgeschlagenen Brenner verwenden, gehen Sie auf die gleiche Weise vor.

Gericht Brenner	Gesamtzeit in Min.	Schritt 1	Schritt 2
Suppen, Cremesuppen			
Fischsuppe			
Schnell	12-17	 8 7-9	 1 5-8
Normal	17-22	 8 11-13	 1 6-9
Wok	10-15	 9 6-8	 4 4-7
Kürbiscreme, Borschtsch-Suppe			
Schnell	30-35	 9 10-12	 5 20-23
Normal	45-50	 9 15-17	 6 30-33
Wok	25-30	 9 8-10	 2 17-20

Gericht Brenner	Gesamtzeit in Min.	Schritt 1	Schritt 2
Minestrone (Gemüsesuppe)			
Schnell	47-52	 9 10-12	 5 37-40
Normal	57-62	 9 10-12	 6 47-50
Wok	43-48	 8 8-10	 3 35-38
Nudeln und Reis			
Spaghetti			
Schnell	18-22	 * 9 8-10	 6 10-12
Normal	20-24	 * 9 10-12	 7 10-12
Wok	18-22	 * 8 8-10	 6 10-12
Reis			
Schnell	17-22	 9 5-7	 2 12-15
Normal	18-23	 9 7-9	 6 11-14
Wok	15-20	 8 4-6	 2 11-14
Ravioli			
Schnell	9-14	 9 4-6	 6 5-8
Normal	17-22	 8 12-14	 8 5-8
Wok	10-15	 8 5-7	 8 5-8
Gemüse und Hülsenfrüchte			
Gekochte Kartoffeln (Püree, Kartoffelsalat)			
Schnell	23-28	 9 8-10	 5 15-18
Normal	25-30	 9 10-12	 6 15-18
Wok	25-30	 7 11-13	 5 14-17
Hummus (pürierte Kichererbsen)			
Schnell	50-55	 9 10-12	 4 40-43
Normal	52-57	 9 12-14	 5 40-43
Wok	47-52	 7 10-12	 5 37-40
Linsen			
Schnell	40-45	 9 8-10	 9 32-35
Normal	50-55	 9 18-20	 6 32-35
Wok	45-50	 6 20-22	 4 25-28
Frittiertes Gemüse			
Schnell	12-17	 * 7 6-8	 * 6 6-9
Normal	15-20	 * 8 8-10	 * 7 7-10
Wok	11-16	 * 7 6-8	 * 5 5-8
Sautiertes frisches Gemüse**			
Wok	6-8	 * 9 6-8	
Schnell	6-8	 * 9 6-8	
Pommes frites			
Wok	15-20	 * 7 15-20	
Schnell	15-20	 * 9 15-20	
Normal	25-30	 * 9 25-30	

Gericht Brenner	Gesamt- zeit in Min.	Schritt 1	Schritt 2
		  	  
Eier			
Shakshuka			
Normal	15-20	 9 10-12	 4 5-8
Schnell	13-18	 8 7-9	 3 6-9
Wok	15-20	 6 11-13	 4 4-7
Omelette (1 Port.)			
Normal	3-5	 * 8 3-5	
Schnell	2-4	 * 9 2-4	
Wok	2-4	 * 5 2-4	
Spanische Tortilla			
Schnell	25-30	 * 9 25-30	
Wok	18-23	 * 9 18-23	
Saucen			
Béchamelsauce**			
Spar	10-15	 * 6 2-4	 * 6 8-11
Normal	10-15	 * 5 2-4	 * 5 8-11
Wok	3-8	 * 5 1-2	 * 5 2-6
Sauce mit Blauschimmelkäse**			
Spar	4-6	 * 7 4-6	
Normal	3-5	 * 7 3-5	
Schnell	3-5	 * 5 3-5	
Napoletana-Sauce			
Normal	18-23	 * 6 2-4	 * 4 16-19
Wok	13-18	 * 7 1-3	 * 5 12-15
Schnell	15-20	 * 8 1-3	 * 6 14-17
Carbonara-Sauce			
Normal	10-15	 * 6 5-7	 * 3 5-8
Schnell	8-13	 * 5 4-6	 * 3 4-7
Spar	10-15	 * 9 5-7	 * 5 5-8
Fisch			
Seehecht auf römische Art			
Schnell	5-10	 * 8 5-10	
Normal	8-13	 * 9 8-13	
Wok	4-9	 * 6 4-9	
Gebackener Lachs			
Schnell	5-10	 * 7 2-4	 1 3-6
Normal	5-10	 * 8 2-4	 1 3-6
Wok	7-12	 * 8 2-4	 1 5-8
Muscheln			
Schnell	5-7	 9 5-7	
Wok	4-6	 9 4-6	
Normal	10-12	 9 10-12	

Gericht Brenner	Gesamt- zeit in Min.	Schritt 1	Schritt 2
		  	  
Fleisch			
Entenbrust (1 Stck)			
Normal	6-8	 * 7 6-8	
Schnell	9-11	 * 7 9-11	
Wok	6-8	 * 5 6-8	
Rinderfilet Stroganoff			
Schnell	8-13	 * 9 8-13	
Wok	5-10	 * 8 5-10	
Normal	12-17	 * 9 12-17	
Hähnchenschnitzel (8 Hähnchenbrustfilets)			
Schnell	7-12	 * 9 2-4	 * 6 5-8
Wok	7-12	 * 9 2-4	 * 6 5-8
Normal	7-12	 * 9 7-12	
Hackfleisch (Fleischpastete, Frikadellen, Bolognese-Sauce)			
Schnell	15-20	 * 8 15-20	
Normal	20-25	 * 9 20-25	
Wok	15-20	 * 6 15-20	
Fertigprodukte			
Gefrorene Krokette (16 Stck)			
Gefrorene Fischstäbchen (12 Stck)			
Schnell	6-10	 8 6-10	
Wok	5-9	 8 5-9	
Normal	8-12	 8 8-12	
Bratwürste (12 Stck.)			
Schnell	5-10	 9 1-3	 7 4-7
Normal	7-12	 9 7-12	
Wok	5-10	 9 1-3	 7 4-7
Brühwürste (12 Stck.)			
Normal	8-13	 9 8-13	
Wok	9-14	 4 9-14	
Schnell	7-12	 7 7-12	
Hamburger (4 Stck)			
Schnell	4-9	 * 9 1-3	 * 7 3-6
Wok	4-9	 * 9 1-3	 * 7 3-6
Normal	5-10	 * 9 1-3	 * 8 4-7
Gefrorenes Gemüse**			
Schnell	7-12	 * 9 7-12	
Wok	5-10	 * 9 5-10	
Normal	12-17	 * 9 12-17	
Pizza (20 cm Durchmesser)			
Wok	4-8	 1 4-8	
Schnell	16-20	 1 16-20	
Normal	20-25	 1 20-25	

Gericht Brenner	Gesamt- zeit in Min.	Schritt 1	Schritt 2
Desserts			
Reispudding**			
Normal	30-35	 * 8 9-11	 * 4 21-24
Spar	40-45	 * 9 12-14	 * 2 28-31
Wok	35-40	 * 7 11-13	 * 1 24-27
Milchschokolade			
Spar	10-14	 * 1 10-14	
Normal	16-20	 * 1 16-20	
Crêpes (4 Stck)			
Schnell	17-22	 * 7 1-3	 * 5 16-19
Wok	8-13	 * 7 1-3	 * 4 7-10
Normal	20-25	 * 8 1-3	 * 6 19-22
Brotpudding			
Schnell	25-30	 * 9 10-12	 * 6 15-18
Wok	23-28	 * 9 8-10	 * 7 15-18
Normal	27-32	 * 9 10-12	 * 7 17-20
Spanischer Pudding**			
Schnell	3-8	 * 5 3-8	
Normal	8-13	 * 5 8-13	
Wok	3-8	 * 2 3-8	
Rührkuchen (im Wasserbad)			
Schnell	35-40	 * 9 35-40	
Wok	40-45	 * 9 40-45	
Normal	45-50	 * 9 45-50	

Kochtipps

- Verwenden Sie für die Zubereitung von Cremesuppen und Hülsenfrüchten einen Schnellkochtopf. Die Garzeit wird deutlich reduziert. Wenn Sie einen Schnellkochtopf verwenden, befolgen Sie die Anweisungen des Herstellers.
- Legen Sie beim Kochen von Kartoffeln und Reis immer einen Deckel auf. Die Garzeit wird dadurch deutlich geringer.
- Bei Pfannengerichten müssen Sie zunächst das Öl erhitzen. Sobald Sie mit dem Braten begonnen haben, halten Sie die Temperatur konstant, indem Sie bei Bedarf die Kochstufe anpassen. Warten Sie beim Zubereiten mehrerer Portionen, bis die Gartemperatur wieder erreicht ist. Wenden Sie die Speisen regelmäßig.

Reinigen und warten

Reinigung

Ist das Gerät einmal abgekühlt, reinigen Sie es mit einem Schwamm, Wasser und Seife.

Reinigen Sie die Oberflächen der Brenneinzerteile nach jeder Benutzung und in kaltem Zustand. Auch die kleinsten Rückstände (überkochende Speisen, Fettspritzer, usw.) brennen sich in die Oberfläche ein und sind später nur schwer zu entfernen. Für eine richtige Flamme müssen die Löcher und Ritzen der Brenner sauber sein.

Das Bewegen einiger Kochgefäße kann Metallspuren auf den Rosten hinterlassen.

Säubern Sie Brenner und Roste mit Seifenwasser und einer nicht metallischen Bürste.

Wenn die Roste Gummiauflagen haben, gehen Sie bei der Reinigung vorsichtig vor. Die Auflagen könnten sich lösen und der Rost das Kochfeld zerkratzen.

Trocknen Sie immer alle Brenner und Roste. Wassertropfen oder feuchte Zonen am Beginn des Kochvorgangs können das Email beschädigen.

Nachdem die Brenner gereinigt und getrocknet sind, versichern Sie sich, dass die Deckel gut auf den Verteilern platziert sind.

Achtung!

- Entfernen Sie zum Reinigen des Gerätes nicht die Bedienelemente. Eintretende Feuchtigkeit kann das Gerät beschädigen.
- Keine Dampfreiniger verwenden. Das Kochfeld kann dadurch beschädigt werden.
- Keine Scheuermittel, Metallschwämme, scharfen Gegenstände, Messer oder ähnliches verwenden, um angetrocknete Essensreste vom Kochfeld zu entfernen.
- Keine Messer, Schaber oder ähnliches zur Reinigung der Verbindungsstelle des Glases mit den Kappen der Brenner, den Metallprofilen oder auf den Glas- oder Aluminiumblenden, falls vorhanden, verwenden.

Pflege

Entfernen Sie übergelaufene Flüssigkeiten sofort. So vermeiden Sie, dass Essensreste ankleben und Sie sparen Mühe und Zeit.

Die Kochgefäße nicht über das Glas ziehen, es können Kratzer entstehen. Ebenso sollte vermieden werden, dass harte oder spitze Gegenstände auf das Glas fallen. Die Ränder des Kochfelds keinen Stößen aussetzen.

Sandkörner (z. B. vom Säubern von Gemüse) zerkratzen die Glasfläche.

Karamellierter Zucker oder übergelaufene Lebensmittel mit hohem Zuckergehalt müssen sofort mittels eines Glasschabers von der Kochstelle entfernt werden.

Störungen, was tun?

In einigen Fällen können aufgetretene Störungen leicht behoben werden. Bevor Sie den Kundendienst rufen, beachten Sie folgende Hinweise:

Störung	Mögliche Ursache	Lösung
Störung der allgemeinen Elek- trik.	Sicherung defekt.	Im Hauptsicherungskasten prüfen, ob die Sicherung defekt ist und ggf. ersetzen.
	Die automatische Sicherung oder ein Fehlerstromschutz- schalter wurde ausgelöst.	Im Hauptbedienfeld prüfen, ob die automatische Siche- rung oder ein Fehlerstromschutzschalter durchgebrannt ist.
Die automatische Zündung funktioniert nicht.	Zwischen den Zündkerzen und den Brennern können sich Reste von Lebensmitteln oder Reinigern befinden.	Der Zwischenraum zwischen Zündkerze und Brenner muss sauber sein.
	Die Brenner sind nass.	Die Brennerdeckel sorgfältig trocknen.
	Die Brennerdeckel sind nicht richtig aufgelegt.	Überprüfen, ob die Deckel richtig aufliegen.
	Das Gerät ist nicht oder falsch geerdet oder die Erdung ist beschädigt.	Setzen Sie sich mit dem Elektroinstallateur in Verbindung.
Ungleichmäßige Brenner- flamme.	Die Brennerteile sind nicht richtig aufgelegt.	Die Brennerteile richtig auf den entsprechenden Brenner auflegen.
	Die Ritzen des Brenners sind verschmutzt.	Ritzen des Brenners säubern.
Der Gasfluss scheint nicht nor- mal zu sein oder es tritt kein Gas aus.	Zwischengeschaltete Ventile sind geschlossen.	Die möglichen zwischengeschalteten Ventile öffnen.
	Bei Verwendung einer Gasflasche überprüfen, dass diese nicht leer ist.	Gasflasche austauschen.
In der Küche riecht es nach Gas.	Ein Gashahn ist offen.	Gashähne schließen.
	Schlechter Anschluss der Gasflasche.	Anschluss der Gasflasche auf Dichtheit prüfen.
	Mögliches Gasleck.	Den Gashahn schließen, den Bereich lüften und sofort einen für die Überprüfung und Zertifizierung der Installa- tion autorisierten Fachmann benachrichtigen. Das Gerät nicht benutzen, bis sichergestellt ist, dass es kein Gasleck an der Installation oder dem Gerät gibt.
Der Brenner schaltet sich sofort nach Loslassen des Bedienknobels aus.	Sie haben den Bedienknobel nicht genügend lange gedrückt.	Sobald der Brenner gezündet hat, den Bedienknobel noch einige Sekunden gedrückt halten.
	Die Ritzen des Brenners sind verschmutzt.	Ritzen des Brenners säubern.

Kundendienst

Wenn Sie unseren Kundendienst anrufen, halten Sie bitte die Erzeugnisnummer (E-Nr.) und die Fertigungsnummer (FD) des Geräts bereit. Diese Information entnehmen Sie dem Typenschild, das unter dem Kochfeld angebracht ist, und dem Etikett in der Bedienungsanleitung.

Die Kontaktdaten aller Länder für den nächstgelegenen Kundendienst finden Sie hier bzw. im beiliegenden Kundendienst-Verzeichnis.

Reparaturauftrag und Beratung bei Störungen

A 0810 550 522
D 089 21 751 751
CH 0848 840 040

Vertrauen Sie auf die Kompetenz des Herstellers. Sie stellen somit sicher, dass die Reparatur von geschulten Servicetechnikern durchgeführt wird, die mit den Original-Ersatzteilen für Ihr Gerät ausgerüstet sind.

Garantiebedingungen

Falls das Gerät wider Erwarten Schäden aufweisen oder Ihre Qualitätsanforderungen nicht erfüllen sollte, setzen Sie uns davon so schnell wie möglich in Kenntnis. Zur gültigen Einlösung der Garantie darf das Gerät nicht unbefugt manipuliert bzw. benutzt worden sein.

Die Garantiebedingungen werden von unserer Vertretung im Land des Gerätekaufs festgelegt. Detaillierte Informationen erhalten Sie in den Verkaufsstellen. Um die Garantie in Anspruch nehmen zu können, müssen Sie den Kaufbeleg für das Gerät vorweisen.

Wir behalten uns das Recht auf Änderungen vor.

Umweltschutz

Wenn sich auf dem Typenschild des Geräts das Symbol  befindet, beachten Sie folgende Hinweise.

Umweltgerecht entsorgen

Entsorgen Sie die Verpackung umweltgerecht.



Dieses Gerät ist entsprechend der europäischen Richtlinie 2012/19/EU über Elektro- und Elektronikaltgeräte (waste electrical and electronic equipment - WEEE) gekennzeichnet.

Die Richtlinie gibt den Rahmen für eine EU-weit gültige Rücknahme und Verwertung der Altgeräte vor.

Die Verpackung Ihres Geräts besteht aus Materialien, die notwendig sind, um einen wirksamen Schutz beim Transport zu garantieren. Diese Materialien sind vollständig wiederverwertbar und verringern damit die Umweltbelastung. So wie wir können auch Sie einen Beitrag zum Umweltschutz leisten, indem Sie folgende Ratschläge beachten:

- Entsorgen Sie die Verpackung in einer Tonne für recyclingfähige Materialien.
- Machen Sie ein nicht mehr benutztes Gerät vor der Entsorgung unbrauchbar. Informieren Sie sich bei Ihrer örtlichen Verwaltung über die Adresse des nächsten Wertstoffhofs und liefern Sie Ihr Gerät dort ab.
- Schütten Sie verwendetes Bratfett oder Öl nicht in das Spülbecken. Sammeln Sie das Öl in einem verschließbaren Gefäß und geben Sie es bei einer Sammelstelle ab oder werfen Sie es, wenn dies nicht möglich ist, in die Mülltonne (so gelangt es auf eine kontrollierte Mülldeponie - vermutlich nicht die beste Lösung, doch wird so kein Wasser verschmutzt).

Table des matières

	Utilisation conforme	13
	Précautions de sécurité importantes	14
	Présentation de l'appareil	15
	Éléments de commande et brûleurs	15
	Accessoires	16
	Brûleurs à gaz	16
	Mise sous tension manuelle	16
	Allumage automatique	16
	Système de sécurité	16
	Éteindre un brûleur	16
	Avertissements	17
	Tableaux et conseils	17
	Récipients appropriés	17
	Conseils d'utilisation	17
	Tableau des cuissons	17
	Nettoyage et maintenance	20
	Nettoyage	20
	Maintenance	20
	Anomalies, que faire ?	21
	Service après-vente	22
	Conditions de garantie	22
	Protection de l'environnement	22
	Élimination écologique	22

Vous trouverez des informations supplémentaires concernant les produits, accessoires, pièces de rechange et services sur Internet sous : www.siemens-home.com et la boutique en ligne : www.siemens-eshop.com

Utilisation conforme

Lisez attentivement ces instructions. Ce n'est qu'à cette condition que vous pourrez utiliser votre appareil efficacement et en toute sécurité. Conservez la notice d'utilisation et d'installation, et remettez-la avec l'appareil si celui-ci change de propriétaire.

Le fabricant est exempt de toute responsabilité si les instructions de cette notice ne sont pas respectées.

Les images de cette notice sont proposées à titre indicatif.

Ne retirez l'appareil de son emballage protecteur qu'au moment de son encastrement. Si vous constatez des dommages sur l'appareil, ne le branchez pas. Contactez notre Service Technique.

Cet appareil correspond à la classe 3, selon la norme EN 30-1-1 pour les appareils à gaz : appareil encastré dans un meuble.

Assurez-vous que l'installation de votre plaque de cuisson est réalisée dans le respect de la notice de montage.

Cet appareil ne peut pas être installé dans des yachts ou des caravanes.

Cet appareil doit être utilisé uniquement dans des endroits suffisamment ventilés.

Cet appareil n'est pas conçu pour un fonctionnement avec une minuterie externe ou une commande à distance.

Tous les travaux d'installation, de branchement, de réglage et d'adaptation à un autre type de gaz doivent être réalisés par un technicien agréé qui doit respecter les normes et la législation applicables, ainsi que les prescriptions des sociétés locales de distribution d'électricité et de gaz. Les dispositions applicables quant à la ventilation seront attentivement respectées.

En sortie d'usine, cet appareil est adapté au type de gaz indiqué sur la plaque signalétique. S'il était nécessaire de le changer, veuillez consulter la notice de montage. Il est recommandé de faire appel à notre service technique pour l'adaptation à un autre type de gaz.

Cet appareil a été conçu pour une utilisation domestique ; son utilisation à titre commercial

ou professionnel est interdite. N'utilisez l'appareil que pour cuisiner, jamais comme chauffage. La garantie ne sera valable que si l'utilisation pour laquelle il a été conçu a été respectée.

Cet appareil est conçu pour une utilisation jusqu'à une altitude maximale de 2 000 m.

Ne laissez pas l'appareil sans surveillance pendant son fonctionnement.

N'utilisez pas de couvercles ou de barrières de protection pour enfants non recommandés par le fabricant de la plaque de cuisson. Ils peuvent provoquer des accidents, notamment en raison de la surchauffe, de la combustion ou du décolllement de fragments de matériaux.

Cet appareil peut être utilisé par des enfants de 8 ans ou plus et par des personnes dotées de capacités physiques, sensorielles ou mentales réduites ou disposant de connaissances ou d'expérience insuffisantes, sous la surveillance d'un tiers responsable de leur sécurité ou bien lorsqu'ils ont reçu des instructions liées à l'utilisation de l'appareil en toute sécurité et qu'ils ont intégré les risques qui en résultent.

Les enfants ne doivent pas jouer avec l'appareil. Le nettoyage et l'entretien effectué par l'utilisateur ne doivent pas être accomplis par des enfants, sauf s'ils sont âgés de 8 ans et plus et qu'un adulte les surveille.

Les enfants de moins de 8 ans doivent être tenus à distance de l'appareil et du cordon d'alimentation.

Précautions de sécurité importantes

Mise en garde – Risque de déflagration !

L'accumulation de gaz non brûlés dans un lieu fermé pourrait comporter un risque de déflagration. Ne placez pas l'appareil dans des courants d'air. Les brûleurs pourraient s'éteindre. Lisez attentivement les instructions et les avertissements concernant le fonctionnement des brûleurs à gaz.

Mise en garde – Risque d'intoxication !

L'utilisation d'un appareil de cuisson à gaz produit de la chaleur, de l'humidité et émet des produits de combustion dans la pièce où il est installé. Assurez-vous que la cuisine soit bien ventilée, en particulier lorsque la plaque de cuisson est en fonctionnement: laissez les orifices de ventilation naturelle ouverts ou installez un dispositif de ventilation mécanique (hotte aspirante). Lorsque l'utilisation de l'appareil est intense et prolongée, une ventilation complémentaire ou plus efficace peut être nécessaire: ouvrez une fenêtre ou augmentez la puissance de la ventilation mécanique.

Mise en garde – Risque de brûlures !

- Les zones de cuisson et les zones adjacentes chauffent fortement. Ne touchez pas les surfaces chaudes. Ne laissez pas les enfants de moins de 8 ans s'approcher.
- Si la bouteille de gaz liquide n'est pas à la verticale, du propane/butane liquide peut parvenir dans l'appareil. Des jets de flamme violents peuvent alors sortir aux brûleurs. Des composants peuvent être endommagés et devenir non étanches avec le temps, si bien que du gaz sort de manière incontrôlée. Les deux peuvent conduire à des brûlures. Utilisez les bouteilles de gaz liquide toujours en position verticale.

Mise en garde – Risque d'incendie !

- Les zones de cuisson chauffent fortement. Ne posez pas d'objets inflammables sur la plaque de cuisson. N'entrez pas d'objets sur la plaque de cuisson.
- Ne stockez ni utilisez de produits chimiques corrosifs, de vapeurs, de matériels inflammables ni de produits non alimentaires sous cet appareil, ni à proximité.

- Les graisses et les huiles surchauffées s'enflamment facilement. Ne vous absentez pas si vous avez mis de la graisse ou de l'huile à chauffer. Si elles s'enflamment, n'éteignez pas le feu avec de l'eau. Couvrez le récipient avec un couvercle hermétique pour étouffer le feu puis éteignez la zone de cuisson.

⚠ Mise en garde – Risque de blessures !

- La présence de fêlures ou de cassures dans la plaque en verre est dangereuses. Éteindre immédiatement tous les brûleurs et tous les éléments chauffants électriques. Retirer la fiche secteur ou déconnecter le fusible dans le boîtier à fusibles. Fermer l'arrivée de gaz. Ne pas toucher la surface de l'appareil. Ne jamais mettre en service un appareil défectueux. Appeler le service après-vente.
- Les brusques changements de température peuvent provoquer la rupture du verre. Pendant l'utilisation de votre plaque de cuisson à gaz, évitez les courants d'air et les déversements de liquides froids.
- Les récipients qui présenteraient des dommages, dont la taille ne serait pas adaptée, qui dépasseraient de la plaque de cuisson ou qui seraient mal placés, pourraient occasionner des lésions graves. Respectez les conseils et les avertissements concernant les récipients de cuisson.
- En cas d'incident, débranchez l'alimentation électrique et de gaz de l'appareil. Pour la réparation, contactez notre service technique.
- Ne manipulez pas l'intérieur de l'appareil. Si nécessaire, contactez notre service technique.
- Si l'un des boutons de commande est bloqué, ne forcez pas. Appelez immédiatement le service technique pour procéder à sa réparation ou à son remplacement.

⚠ Mise en garde – Risque de décharge électrique !

- Ne pas utiliser de machines de nettoyage à vapeur pour nettoyer l'appareil.
- Les fêlures et cassures dans la plaque en verre peuvent occasionner des chocs électriques. Couper le fusible dans la boîte à fusibles. Appeler le service après-vente.

Présentation de l'appareil

Sur la vue d'ensemble des modèles, vous retrouverez votre appareil avec les puissances des brûleurs.
→ Page 2

Éléments de commande et brûleurs

Le brûleur correspondant est indiqué sur chaque manette de commande. Les boutons de commande vous permettent de régler les puissances requises entre les valeurs maximales et minimales selon les différentes positions. Ne tentez jamais de passer directement de la position 0 à la position 1 ou de la position 1 à la position 0.

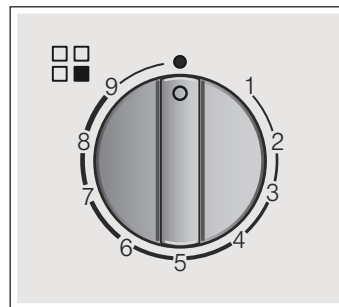

Affichages

	Brûleur commandé par la manette de commande
	Brûleur désactivé
9	Puissance de chauffe la plus élevée et allumage électrique
1	Puissance de chauffe la plus faible

Pour un fonctionnement correct de l'appareil, il est indispensable de s'assurer que les grilles et toutes les pièces des brûleurs sont correctement mises en place. N'intervertissez pas les couvercles des brûleurs.

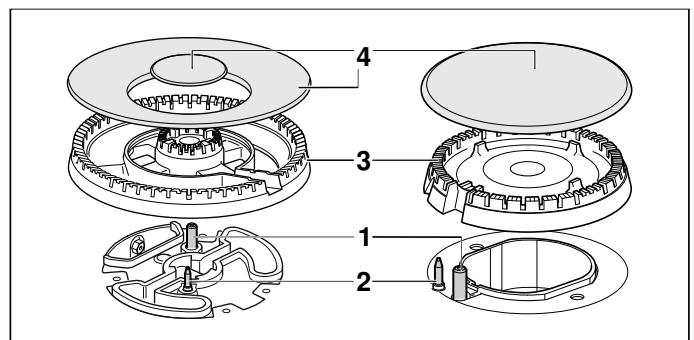

Éléments

1	Bougie d'allumage
2	Thermocouple
3	Corps du brûleur
4	Chapeau du brûleur

Accessoires

Selon le modèle, la plaque de cuisson peut inclure les accessoires suivants. Ceux-ci peuvent également être achetés auprès du Service Technique.

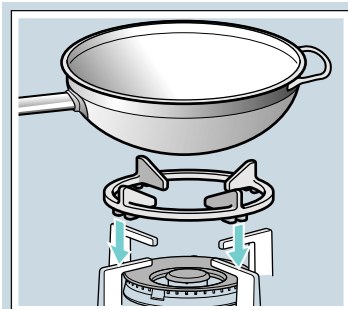

Accessoire pour Wok

Uniquement pour l'utilisation de récipients de cuisson au fond bombé, de plaques à griller ou de casseroles en terre cuite sur brûleurs wok.

Afin de prolonger la durée de vie de l'appareil, l'utilisation de l'accessoire pour Wok est recommandée.

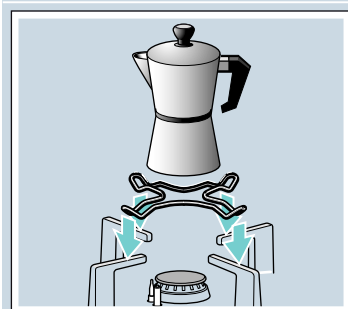

Support supplémentaire pour machine à Espresso

Uniquement pour l'utilisation d'ustensiles dont le fond présente un diamètre inférieur à 12 cm sur le plus petit brûleur.

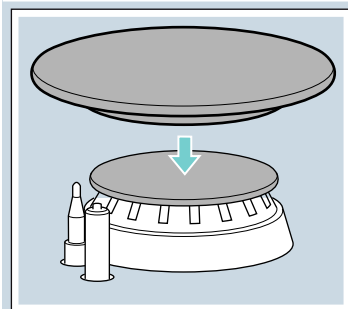

Simmer Cap

Ce couvercle est recommandé pour une cuisine à puissance minimum. Pour l'utiliser, il est nécessaire de placer le couvercle Simmer Cap sur le couvercle du brûleur auxiliaire.

Code

- HZ298107 Accessoire pour Wok : grille en fonte (4-5 kW)
 HZ298114 Support supplémentaire pour machine à Espresso
 HZ211310 Simmer Cap

Le fabricant décline toute responsabilité si ces accessoires ne sont pas utilisés ou sont employés de manière incorrecte.

Brûleurs à gaz

Mise sous tension manuelle

1. Appuyez sur la manette de commande du brûleur sélectionné, puis tournez-la vers la gauche jusqu'à la puissance de chauffe la plus élevée.
2. Approchez un allumeur ou une flamme (briquet, allumette, etc.) du brûleur.

Allumage automatique

Si votre table de cuisson dispose d'un allumage automatique (bougies d'allumage) :

1. Appuyez sur la manette de commande du brûleur sélectionné, puis tournez-la vers la gauche jusqu'à la puissance de chauffe la plus élevée. Pendant que vous maintenez enfoncée la manette de commande, des étincelles jaillissent sur tous les brûleurs. Le brûleur s'allume.
2. Relâchez la manette de commande.
3. Tournez la manette de commande sur la position souhaitée.

Si un allumage se produit, éteignez le brûleur et répétez l'étape précédemment décrite. Cette fois, maintenez enfoncée la manette de commande plus longtemps (jusqu'à 10 secondes).

⚠ Mise en garde – Risque de déflagration !

Si le brûleur ne s'allume pas au bout de 15 secondes, fermez la manette de commande et ouvrez la porte ou la fenêtre de la pièce. Attendez au moins une minute avant de rallumer le brûleur.

Remarque : Veillez à une propreté maximale. Si les bougies d'allumage sont encrassées, cela peut entraîner un allumage défectueux. Nettoyez régulièrement les bougies d'allumage avec une petite brosse non métallique. Veillez à ne pas soumettre les bougies d'allumage à des chocs importants.

Système de sécurité

Votre plaque de cuisson dispose d'un système de sécurité (thermocouple) qui empêche le passage de gaz si les brûleurs s'éteignent accidentellement.

Pour que cet dispositif soit actif :

1. Allumez le brûleur normalement.
2. Maintenez le bouton de commande enfoncé sans le lâcher pendant 4 secondes après l'allumage de la flamme.

Éteindre un brûleur

Tournez le bouton de commande correspondant vers la droite jusqu'à la position 0.

Quelques secondes après avoir éteint le brûleur, un son est émis (coup sec). Il ne s'agit pas d'une anomalie, ceci signifie que la sécurité a été désactivée.

Avertissements

Pendant le fonctionnement du brûleur, il est normal d'entendre un léger sifflement.

Lors des premières utilisations, il est normal que des odeurs se dégagent. Mais cela ne suppose aucun dysfonctionnement. Ces odeurs disparaîtront petit à petit.

Une flamme de couleur orange est normale. Ceci est dû à la présence de poussière dans l'atmosphère, de liquides déversés, etc.

S'il se produit une extinction accidentelle des flammes du brûleur, éteignez le bouton de commande du brûleur et attendez au moins 1 minute avant de le rallumer.

Tableaux et conseils

Récipients appropriés

Brûleurs	Diamètre minimum du récipient	Diamètre maximum du récipient
Brûleur wok	22 cm	30 cm
Brûleur rapide	22 cm	26 cm
Brûleur standard	14 cm	20 cm
Brûleur éco	12 cm	16 cm

Attention !

Afin d'éviter d'endommager l'appareil, utilisez toujours l'accessoire pour Wok lorsque vous cuisinez avec des plaques à griller ou des casseroles en terre cuite. → Page 16

Conseils d'utilisation

Les conseils suivants vous aideront à économiser de l'énergie et à éviter d'endommager les récipients :

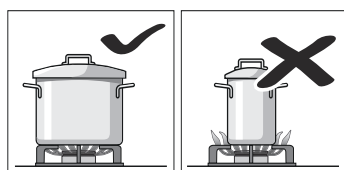

Utilisez des récipients de la taille appropriée à chaque brûleur.

N'utilisez pas de petits récipients sur les grands brûleurs. La flamme ne doit pas toucher les côtés du récipient.

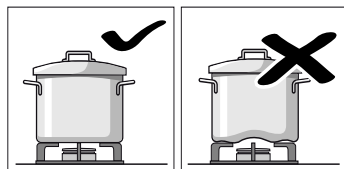

N'utilisez pas de récipients déformés, ayant tendance à être instables sur la plaque de cuisson. Les récipients pourraient se renverser.

N'utilisez que des récipients à base plane et épaisse.

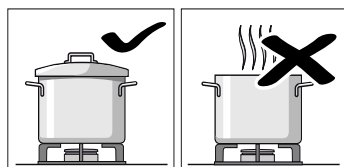

Ne cuisinez pas sans couvercle ni avec celui-ci mal mis. Vous risqueriez ainsi de perdre une partie de l'énergie.

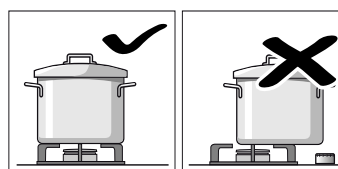

Placez le récipient bien au centre du brûleur. Dans le cas contraire, il risque de se renverser.

Ne placez pas les récipients de grande taille sur les brûleurs situés près des boutons de commandes. Ils risqueraient d'être endommagés en raison de l'excès de chaleur.

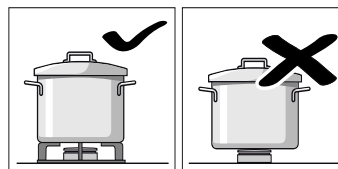

Placez les récipients sur les grilles, jamais directement sur le brûleur. Vérifiez que les grilles et les couvercles des brûleurs sont bien placés avant de les utiliser.

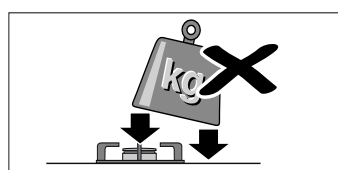

Manipulez soigneusement les récipients sur la plaque de cuisson. Ne cognez pas la plaque de cuisson et n'y posez pas d'objets lourds.

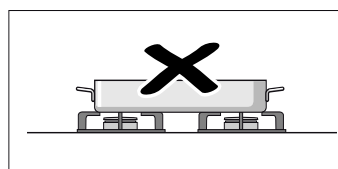

N'utilisez pas deux brûleurs ou sources de chaleur pour un seul récipient.

Évitez d'utiliser des plaques pour les grillades, des casseroles en céramique, etc. longtemps à la puissance maximum.

Tableau des cuissons



Le tableau suivant répertorie les positions de chauffe et les temps de cuisson de différents plats. Les données sont des valeurs de référence pour quatre personnes.

Les temps de cuisson et les positions de chauffe dépendent du type, du poids et de la qualité des aliments, ainsi que des ustensiles utilisés. Des écarts sont donc possibles.







Utilisez toujours un ustensile approprié et positionnez-le au centre du brûleur. Consultez les informations sur le diamètre de l'ustensile. → "Récipients appropriés"

Informations sur le tableau

La préparation de chaque plat se compose d'une ou de deux étapes. Chaque étape présente des informations sur :

-  Le mode de cuisson
-  La position de chauffe
-  La durée en minutes













Modes de cuisson répertoriés dans le tableau

-  Porter à ébullition
-  Continuer la cuisson
-  Faire monter la pression dans la cocotte minute
-  Maintenir la pression dans la cocotte minute
-  Saisir fortement
-  Saisir légèrement
-  Faire fondre, fondre
- * Sans couvercle
- ** Mélanger en continu

Remarque : ces symboles ne se trouvent pas sur l'appareil. Ils servent d'orientation pour les différents modes de cuisson.

Le tableau présente des indications pour la préparation de plats sur différents brûleurs. L'option recommandée est le premier brûleur. Tous les brûleurs de la table de cuisson sont décrits dans la vue d'ensemble des modèles. → Page 2

Exemple :



















Plat	Durée totale en min.	Étape 1			Étape 2		
Brûleurs							
Soupes, soupes crémeuses							
Soupe au poisson							
Rapide	12-17		8	7-9		1	5-8
Standard	17-22		8	11-13		1	6-9
Wok	10-15		9	6-8		4	4-7



























































Cet exemple explique la préparation d'une soupe au poisson à l'aide du brûleur rapide, du brûleur standard et du brûleur wok.



















































Avec le brûleur rapide (option recommandée), la cuisson dure entre 12 et 17 minutes.











































- Étape 1 : porter à ébullition. Utiliser la position de chauffe 8 pendant 7 à 9 minutes.
- Étape 2 : continuer la cuisson. Passer à la position de chauffe 1 pendant 5 à 8 minutes.







Si vous utilisez l'un des autres brûleurs proposés, procédez de la même manière.

Plat	Durée totale en min.	Étape 1			Étape 2		
Brûleurs							
Soupes, soupes crémeuses							
Soupe au poisson							
Rapide	12-17		8	7-9		1	5-8
Standard	17-22		8	11-13		1	6-9
Wok	10-15		9	6-8		4	4-7
Crème de potiron, bortsch (soupe de betterave)							
Rapide	30-35		9	10-12		5	20-23
Standard	45-50		9	15-17		6	30-33
Wok	25-30		9	8-10		2	17-20

Plat	Durée totale en min.	Étape 1			Étape 2		
Brûleurs							
Minestrone (soupe de légumes)							
Rapide	47-52		9	10-12		5	37-40
Standard	57-62		9	10-12		6	47-50
Wok	43-48		8	8-10		3	35-38
Pâtes et riz							
Spaghettis							
Rapide	18-22		9	8-10		6	10-12
Standard	20-24		9	10-12		7	10-12
Wok	18-22		8	8-10		6	10-12
Riz							
Rapide	17-22		9	5-7		2	12-15
Standard	18-23		9	7-9		6	11-14
Wok	15-20		8	4-6		2	11-14
Ravioli							
Rapide	9-14		9	4-6		6	5-8
Standard	17-22		8	12-14		8	5-8
Wok	10-15		8	5-7		8	5-8
Légumes et légumes secs							
Pommes de terre cuites (purée, salade de pommes de terre)							
Rapide	23-28		9	8-10		5	15-18
Standard	25-30		9	10-12		6	15-18
Wok	25-30		7	11-13		5	14-17
Hummus (purée de pois chiches)							
Rapide	50-55		9	10-12		4	40-43
Standard	52-57		9	12-14		5	40-43
Wok	47-52		7	10-12		5	37-40
Lentilles							
Rapide	40-45		9	8-10		9	32-35
Standard	50-55		9	18-20		6	32-35
Wok	45-50		6	20-22		4	25-28
Légumes frits							
Rapide	12-17		* 7	6-8		* 6	6-9
Standard	15-20		* 8	8-10		* 7	7-10
Wok	11-16		* 7	6-8		* 5	5-8
Légumes frais sautés**							
Wok	6-8		* 9	6-8			
Rapide	6-8		* 9	6-8			
Frites							
Wok	15-20		* 7	15-20			
Rapide	15-20		* 9	15-20			
Standard	25-30		* 9	25-30			

Plat Brûleurs	Durée totale en min.	Étape 1			Étape 2		
							
œufs							
Shakshuka							
Standard	15-20	 9	10-12	 4	5-8		
Rapide	13-18	 8	7-9	 3	6-9		
Wok	15-20	 6	11-13	 4	4-7		
Omelette (1 port.)							
Standard	3-5	 * 8	3-5				
Rapide	2-4	 * 9	2-4				
Wok	2-4	 * 5	2-4				
Tortilla espagnole							
Rapide	25-30	 * 9	25-30				
Wok	18-23	 * 9	18-23				
Sauces							
Sauce béchamel**							
Éco	10-15	 * 6	2-4	 * 6	8-11		
Standard	10-15	 * 5	2-4	 * 5	8-11		
Wok	3-8	 * 5	1-2	 * 5	2-6		
Sauce avec bleu**							
Éco	4-6	 * 7	4-6				
Standard	3-5	 * 7	3-5				
Rapide	3-5	 * 5	3-5				
Sauce napolitaine							
Standard	18-23	 * 6	2-4	 * 4	16-19		
Wok	13-18	 * 7	1-3	 * 5	12-15		
Rapide	15-20	 * 8	1-3	 * 6	14-17		
Sauce carbonara							
Standard	10-15	 * 6	5-7	 * 3	5-8		
Rapide	8-13	 * 5	4-6	 * 3	4-7		
Éco	10-15	 * 9	5-7	 * 5	5-8		
Poisson							
Merlan à la romaine							
Rapide	5-10	 * 8	5-10				
Standard	8-13	 * 9	8-13				
Wok	4-9	 * 6	4-9				
Saumon cuit							
Rapide	5-10	 * 7	2-4	 1	3-6		
Standard	5-10	 * 8	2-4	 1	3-6		
Wok	7-12	 * 8	2-4	 1	5-8		
Moules							
Rapide	5-7	 9	5-7				
Wok	4-6	 9	4-6				
Standard	10-12	 9	10-12				

Plat Brûleurs	Durée totale en min.	Étape 1			Étape 2		
							
Viandes							
Magret de canard (1 pièce)							
Standard	6-8	 * 7	6-8				
Rapide	9-11	 * 7	9-11				
Wok	6-8	 * 5	6-8				
Filet de bœuf Stroganoff							
Rapide	8-13	 * 9	8-13				
Wok	5-10	 * 8	5-10				
Standard	12-17	 * 9	12-17				
Blancs de poulet (8 filets de poulet)							
Rapide	7-12	 * 9	2-4	 * 6	5-8		
Wok	7-12	 * 9	2-4	 * 6	5-8		
Standard	7-12	 * 9	7-12				
Viande hâchée (tourte à la viande, boulettes de viande, sauce bolognaise)							
Rapide	15-20	 * 8	15-20				
Standard	20-25	 * 9	20-25				
Wok	15-20	 * 6	15-20				
Plats cuisinés							
Croquettes surgelées (16 pièces)							
Bâtonnets de poisson surgelés (12 pièces)							
Rapide	6-10	 8	6-10				
Wok	5-9	 8	5-9				
Standard	8-12	 8	8-12				
Saucisses à griller (12 pièces)							
Rapide	5-10	 9	1-3	 7	4-7		
Standard	7-12	 9	7-12				
Wok	5-10	 9	1-3	 7	4-7		
Saucisses (12 pièces)							
Standard	8-13	 9	8-13				
Wok	9-14	 4	9-14				
Rapide	7-12	 7	7-12				
Hamburger (4 pièces)							
Rapide	4-9	 * 9	1-3	 * 7	3-6		
Wok	4-9	 * 9	1-3	 * 7	3-6		
Standard	5-10	 * 9	1-3	 * 8	4-7		
Légumes congelés**							
Rapide	7-12	 * 9	7-12				
Wok	5-10	 * 9	5-10				
Standard	12-17	 * 9	12-17				
Pizza (diamètre 20 cm)							
Wok	4-8	 1	4-8				
Rapide	16-20	 1	16-20				
Standard	20-25	 1	20-25				

Plat Brûleurs	Durée totale en min.	Étape 1		Étape 2	
					
Desserts					
Riz au lait**					
Standard	30-35	 *	8 9-11	 *	4 21-24
Éco	40-45	 *	9 12-14	 *	2 28-31
Wok	35-40	 *	7 11-13	 *	1 24-27
Chocolat au lait					
Éco	10-14	 *	1 10-14		
Standard	16-20	 *	1 16-20		
Crêpes (4 pièces)					
Rapide	17-22	 *	7 1-3	 *	5 16-19
Wok	8-13	 *	7 1-3	 *	4 7-10
Standard	20-25	 *	8 1-3	 *	6 19-22
Pudding de pain					
Rapide	25-30	 *	9 10-12	 *	6 15-18
Wok	23-28	 *	9 8-10	 *	7 15-18
Standard	27-32	 *	9 10-12	 *	7 17-20
Flan espagnol**					
Rapide	3-8	 *	5 3-8		
Standard	8-13	 *	5 8-13		
Wok	3-8	 *	2 3-8		
Génoise (au bain-marie)					
Rapide	35-40	 *	9 35-40		
Wok	40-45	 *	9 40-45		
Standard	45-50	 *	9 45-50		

Conseils de cuisson

- Utilisez une cocotte minute pour préparer les soupes et les légumes secs. Le temps de cuisson est ainsi considérablement réduit. Si vous utilisez une cocotte minute, suivez les instructions du fabricant.
- Utilisez toujours un couvercle pour cuire les pommes de terre et le riz. Le temps de cuisson est ainsi considérablement réduit.
- Pour les poêlées, vous devez d'abord faire chauffer l'huile. Dès que vous commencez à faire frire vos aliments, maintenez la température en ajustant si besoin la position de chauffe. Si vous préparez plusieurs portions, patientez jusqu'à ce que la température de cuisson soit de nouveau atteinte. Retournez régulièrement les aliments.

Nettoyage et maintenance

Nettoyage

Quand l'appareil a refroidi, nettoyez-le avec une éponge, de l'eau et du savon.

Après chaque utilisation, nettoyez la surface des différents éléments du brûleur quand il a refroidi. Si des restes sont laissés (aliments recuits, gouttes de graisse, etc.), même infimes, ils s'incrusteront dans la surface et seront plus difficiles à éliminer par la suite. Les trous et les rainures doivent être propres afin que la flamme soit optimale.

Le frottement de certains récipients peut laisser des traces métalliques sur les grilles.

Lavez les brûleurs et les grilles à l'eau savonneuse et frottez-les à l'aide d'une brosse non métallique.

Si les grilles disposent de chevilles en caoutchouc, faites très attention en les nettoyant. Les chevilles peuvent se détacher et la grille peut rayer la plaque de cuisson.

Séchez toujours complètement les brûleurs et les grilles. La présence de gouttes d'eau ou de zones humides au début de la cuisson peut détériorer l'émail.

Après le nettoyage et le séchage des brûleurs, assurez-vous que les couvercles sont bien placés sur le diffuseur.

Attention !

- Ne retirez pas les éléments de commande pour nettoyer l'appareil. Si de l'humidité pénètre dans l'appareil, cela risque de l'endommager.
- N'utilisez pas de machines de nettoyage à vapeur. Cela pourrait endommager la plaque de cuisson.
- N'utilisez jamais de produits abrasifs, lavettes en acier, objets tranchants, couteaux, etc., pour retirer les restes d'aliments ayant durci sur la plaque de cuisson.
- N'utilisez pas de couteaux, de racleurs ou d'objets similaires pour nettoyer l'union entre le verre et les caches des brûleurs, les profilés métalliques ni sur les panneaux en verre ou aluminium, le cas échéant.

Maintenance

Nettoyez immédiatement tous les liquides qui coulent. Vous éviterez ainsi que les restes d'aliment ne collent et économiserez des efforts inutiles.

Ne faites pas glisser les récipients sur le verre car ils pourraient le rayer. De plus, évitez les chutes d'objets durs ou pointus sur la plaque en verre. Ne frappez la plaque de cuisson sur aucun de ses angles.

Les grains de sable (provenant par exemple du nettoyage des légumes) rayent la surface du verre.

Le sucre fondu ou des aliments à teneur élevée en sucre ayant débordés doivent être immédiatement retirés de la zone de cuisson à l'aide d'un racleur en verre.

Anomalies, que faire ?

Dans certains cas, les défauts survenus peuvent facilement être éliminés. Avant d'appeler le service après-vente, observez les remarques suivantes :

Anomalie	Cause probable	Solution
Le fonctionnement électrique général est en panne.	Fusible défectueux.	Vérifiez dans le boîtier de fusibles général si le fusible est en panne et remplacez-le.
	L'interrupteur magnétothermique ou un interrupteur différentiel a sauté.	Vérifiez dans le tableau de distribution électrique si l'interrupteur magnétothermique ou un interrupteur différentiel a sauté.
L'allumage automatique ne fonctionne pas.	Il peut y avoir des résidus d'aliments ou de nettoyage entre les bougies et les brûleurs.	L'espace entre la bougie et le brûleur doit être propre.
	Les brûleurs sont mouillés.	Séchez soigneusement les couvercles du brûleur.
	Les couvercles du brûleur sont mal placés.	Vérifiez que les couvercles sont bien placés.
	L'appareil n'est pas raccordé à la terre, est mal raccordé à la terre, ou la prise de terre est défectueuse.	Contactez votre installateur électrique.
La flamme du brûleur n'est pas uniforme.	Les pièces du brûleur sont mal placées.	Placez correctement les pièces sur le brûleur correspondant.
	Les rainures du brûleur sont sales.	Nettoyez les rainures du brûleur.
Le flux de gaz ne paraît pas normal ou aucun gaz ne sort.	Le passage de gaz est obstrué par des robinets intermédiaires.	Ouvrez les robinets intermédiaires éventuels.
	Si le gaz provient d'une bouteille, vérifiez qu'elle n'est pas vide.	Changez la bouteille.
Il y a une odeur de gaz dans la cuisine.	Un robinet est ouvert.	Fermez les robinets.
	Mauvais raccord de la bouteille.	Vérifiez que le raccord est parfait.
	Fuite de gaz éventuelle.	Fermez l'arrivée générale du gaz, aérez l'enceinte et prévenez immédiatement un technicien d'installation agréé afin qu'il vérifie et qu'il atteste du bon fonctionnement de l'installation. N'utilisez pas l'appareil jusqu'à ce que l'absence de fuite de gaz dans l'installation ou l'appareil ait été vérifiée.
Le brûleur s'éteint immédiatement après avoir relâché le bouton de commande.	Vous n'avez pas maintenu le bouton de commande enfoncé suffisamment longtemps.	Une fois le brûleur allumé, maintenez le bouton de commande enfoncé quelques secondes de plus.
	Les rainures du brûleur sont sales.	Nettoyez les rainures du brûleur.

Service après-vente

Si vous faites appel à notre Service Technique, vous devez communiquer le numéro de produit (E-Nr.) ainsi que le numéro de fabrication (FD) de l'appareil. Cette information figure sur la plaque signalétique située sur la partie inférieure de la plaque de cuisson, et sur l'étiquette de la notice d'utilisation.

Vous trouverez les données de contact pour tous les pays dans l'annuaire ci-joint du service après-vente.

Commande de réparation et conseils en cas de dérangements

B 070 222 142
FR 01 40 10 12 00
CH 0848 840 040

Faites confiance à la compétence du fabricant. Vous garantissez ainsi que la réparation sera effectuée par des techniciens de SAV formés qui disposent des pièces de rechange d'origine adaptées à votre appareil.

Conditions de garantie

Si, contrairement à nos attentes, l'appareil présente un dommage ou ne respecte pas les exigences de qualité prévues, veuillez nous l'indiquer dans les plus brefs délais. Pour que la garantie soit valide, l'appareil ne devra pas avoir été manipulé, ni soumis à une mauvaise utilisation.

Les conditions de garantie applicables sont celles établies par la représentation de notre entreprise dans le pays où l'achat a été effectué. Il est possible d'obtenir des informations détaillées dans les points de vente. Il est nécessaire de présenter le bon d'achat pour bénéficier de la garantie.

Tout droit de modification réservé.

Protection de l'environnement

Si la plaque signalétique de l'appareil comporte le symbole , observez les remarques suivantes.

Élimination écologique



Éliminez l'emballage en respectant l'environnement.



Cet appareil est marqué selon la directive européenne 2012/19/UE relative aux appareils électriques et électroniques usagés (waste electrical and electronic equipment - WEEE). La directive définit le cadre pour une reprise et une récupération des appareils usagés applicables dans les pays de la CE.

L'emballage de votre appareil a été fabriqué avec les matériaux indispensables pour garantir une protection efficace pendant le transport. Ces matériaux sont entièrement recyclables, ce qui réduit l'impact sur l'environnement. Nous vous encourageons à contribuer également à la préservation de l'environnement, en suivant les conseils ci-dessous :

- déposez l'emballage dans une benne de recyclage adaptée,
- avant de vous défaire d'un appareil, mettez-le hors d'état. Consultez votre administration locale pour connaître l'adresse du centre de collecte de matériels recyclables le plus près de chez vous, et apportez-le à ce site,
- ne jetez pas l'huile usagée dans l'évier Conservez-la dans un récipient fermé et remettez-le à un point de collecte ou, le cas échéant, dans un bac approprié (qui sera remis à un déversoir contrôlé ; ce n'est probablement pas la meilleure solution, mais nous évitons ainsi de polluer l'eau).

Indice

	Conformità d'uso	23
	Importanti avvertenze di sicurezza	24
	Conoscere l'apparecchio	25
	Elementi di comando e bruciatori	25
	Accessori	26
	Bruciatori a gas	26
	Attivazione manuale	26
	Accensione automatica	26
	Sistema di sicurezza	26
	Spegnere un bruciatore	26
	Avvertenze	27
	Tabelle e consigli	27
	Recipienti adeguati	27
	Avvertenze per l'uso	27
	Tabella di cottura	27
	Pulizia e manutenzione	30
	Pulizia	30
	Manutenzione	30
	Malfunzionamento, che fare?	31
	Servizio assistenza clienti	32
	Condizioni di garanzia	32
	Tutela dell'ambiente	32
	Smaltimento ecocompatibile	32

Per ulteriori informazioni su prodotti, accessori, pezzi di ricambio e servizi è possibile consultare il sito Internet www.siemens-home.com e l'eShop www.siemens-eshop.com

Conformità d'uso

Leggere attentamente le presenti istruzioni. Un'attenta lettura garantirà una manipolazione sicura ed efficace dell'apparecchio. Conservare le istruzioni d'uso e installazione e lasciarle sempre a corredo dell'apparecchio in caso di nuovo proprietario.

Il costruttore declina ogni responsabilità in caso di mancata osservanza delle disposizioni del presente manuale.

Le immagini rappresentate in queste istruzioni hanno carattere orientativo.

Non estrarre l'apparecchio dall'imballaggio di protezione fino al momento dell'installazione. Se l'apparecchio risulta danneggiato, non collegarlo all'alimentazione. Contattare il nostro servizio tecnico.

Questo apparecchio rientra nella classe 3 della norma EN 30-1-1 per gli apparecchi a gas: apparecchio incassato in un mobile.

Per l'installazione del nuovo piano di cottura, attenersi strettamente alle istruzioni di montaggio.

Questo apparecchio non può essere installato in yacht o camper.

L'apparecchio deve essere utilizzato solo in luoghi sufficientemente ventilati.

Questo apparecchio non è da utilizzare con un timer esterno o un telecomando separato.

Tutte le operazioni di installazione, connessione, regolazione e adattamento ad altri tipi di gas devono essere effettuate da un tecnico autorizzato, nel rispetto della normativa e della legislazione applicabili, nonché delle prescrizioni delle società locali di fornitura di gas ed elettricità. Fare particolare attenzione alle disposizioni applicabili in materia di ventilazione.

Questo apparecchio viene predisposto in fabbrica per il tipo di gas indicato sulla targa identificativa. Se fosse necessario modificarlo, consultare le istruzioni di montaggio. Per l'adattamento ad altri tipi di gas, si consiglia di rivolgersi al nostro servizio tecnico.

Questo apparecchio è stato concepito esclusivamente per uso domestico, non è consentito l'uso a scopi commerciali o professionali. Utilizzare l'apparecchio solo per

cucinare e non quale fonte di riscaldamento. La garanzia ha validità solo se viene rispettato l'utilizzo per il quale è stato concepito.

Questo apparecchio è progettato solo per l'utilizzo fino ad un'altezza di massimo 2000 metri sul livello del mare.

Non lasciare l'apparecchio incustodito quando è in funzione.

Non utilizzare coperchi o barriere di sicurezza per bambini non consigliate dal produttore del piano di cottura. Possono provocare degli incidenti, ad es. dovuti al surriscaldamento, all'accensione o al distacco di frammenti di materiale.

Questo apparecchio può essere utilizzato da bambini di età pari o superiore a 8 anni e da persone con ridotte facoltà fisiche, sensoriali o mentali nonché da persone prive di sufficiente esperienza o conoscenza dello stesso se sorvegliate da una persona responsabile della loro sicurezza o se istruite in merito all'utilizzo sicuro dell'apparecchio e consapevoli degli eventuali rischi derivanti da un utilizzo improprio.

I bambini non devono utilizzare l'apparecchio come un giocattolo. I bambini non devono né pulire né utilizzare l'apparecchio da soli a meno che non abbiano un'età superiore agli 8 anni e che siano assistiti da parte di un adulto.

Tenere lontano dall'apparecchio e dal cavo di alimentazione i bambini di età inferiore agli 8 anni.

Importanti avvertenze di sicurezza

Avviso – Pericolo di deflagrazione!

L'accumulo di gas incombusto in un locale chiuso comporta pericolo di deflagrazione. Non esporre l'apparecchio a correnti d'aria. I bruciatori potrebbero spegnersi. Leggere attentamente le istruzioni e le avvertenze relative al funzionamento dei bruciatori a gas.

Avviso – Pericolo di intossicazione!

L'uso di un apparecchio di cottura a gas genera calore, umidità e prodotti di combustione nel locale in cui è installato. Ventilare bene la cucina, specialmente quando il piano di cottura è in funzione: mantenere libere le aperture di ventilazione naturale oppure installare un dispositivo di ventilazione meccanica (cappa aspirante). L'uso intenso e prolungato dell'apparecchio può richiedere una ventilazione complementare o più efficace: aprire una finestra o incrementare la potenza della ventilazione meccanica.

Avviso – Pericolo di ustioni!

- Le zone di cottura e le superfici vicine si surriscaldano molto. Non toccare mai le superfici ad alta temperatura. Tenere lontano i bambini al di sotto degli 8 anni.
- Se la bombola del gas liquido non si trova in posizione verticale, il propano/butano liquido può penetrare nell'apparecchio. Potrebbero generarsi violente fiammate dai bruciatori. I componenti potrebbero venire danneggiati e col tempo non essere più a tenuta, provocando la fuoriuscita incontrollata di gas. In entrambi i casi sussiste il pericolo di ustioni. Utilizzare le bombole del gas liquido sempre in posizione verticale.

Avviso – Pericolo di incendio!

- Le zone di cottura si surriscaldano molto. Non collocare oggetti infiammabili sul piano di cottura. Non conservare alcun oggetto sul piano di cottura.
- Non conservare e non utilizzare, sotto questo elettrodomestico e nelle sue vicinanze, prodotti chimici corrosivi, vapori, materiali infiammabili o prodotti non alimentari.

- Grassi o olio surriscaldati possono infiammarsi facilmente. Non allontanarsi dall'apparecchio durante il riscaldamento di grassi od olio. In caso di incendio, non tentare di spegnere le fiamme con l'acqua. Coprire il recipiente per soffocare il fuoco e scollegare la zona di cottura.

⚠ Avviso – Pericolo di lesioni!

- Rotture, incrinature o crepe nella piastra in vetro sono pericolose. Spegnerne immediatamente tutti i bruciatori e ogni elemento riscaldante elettrico. Togliere la spina o disattivare il fusibile nella scatola dei fusibili. Chiudere l'alimentazione del gas. Non toccare la superficie dell'apparecchio. Non mettere mai in funzione un apparecchio difettoso. Rivolgersi al servizio di assistenza clienti.
- Gli sbalzi termici possono provocare la rottura del vetro. Durante l'uso del piano di cottura, evitare le correnti d'aria e non versare liquidi freddi.
- I recipienti danneggiati, di dimensioni inadeguate, che eccedano i bordi del piano di cottura o siano mal posizionati possono causare lesioni gravi. Seguire le avvertenze e i consigli relativi ai recipienti da cucina.
- In caso di guasto, chiudere il gas e scollegare l'alimentazione elettrica. Per procedere a eventuali riparazioni, contattare il nostro servizio tecnico.
- Non manomettere l'interno dell'apparecchio. In caso di necessità, contattare il nostro servizio tecnico.
- Non forzare le manopole se risultasse impossibile ruotarle. Chiamare immediatamente il servizio tecnico affinché proceda alla riparazione o alla sostituzione.

⚠ Avviso – Pericolo di scariche elettriche!

- Non utilizzare dispositivi di pulizia a vapore per pulire l'apparecchio.
- Rotture, incrinature o crepe nella piastra in vetro possono causare scariche elettriche. Disattivare il fusibile nella scatola dei fusibili. Rivolgersi al servizio di assistenza clienti.

Conoscere l'apparecchio

Nella panoramica dei modelli è possibile trovare il proprio apparecchio con le relative potenze dei bruciatori. → *Pagina 2*

Elementi di comando e bruciatori

Su ciascuna manopola di comando è contrassegnato il corrispondente bruciatore. Con le manopole di comando è possibile impostare, in corrispondenza delle diverse posizioni, la potenza di volta in volta necessaria tra i valori massimi e minimi. Non cercare mai di passare dalla posizione 0 direttamente alla posizione 1 o dalla posizione 1 alla posizione 0.

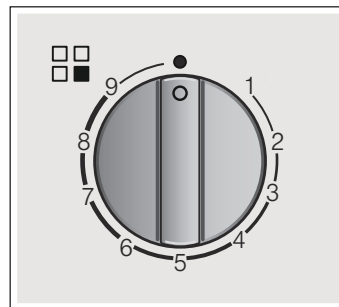

Indicatori

	Bruciatore comandato dalla manopola di comando
	Bruciatore disattivato
9	Livello di potenza massimo e accensione elettrica
1	Livello di potenza minimo

Per un corretto funzionamento dell'apparecchio, è indispensabile verificare che le griglie e tutti gli elementi dei bruciatori siano collocati correttamente. Non scambiare i coperchi dei bruciatori.

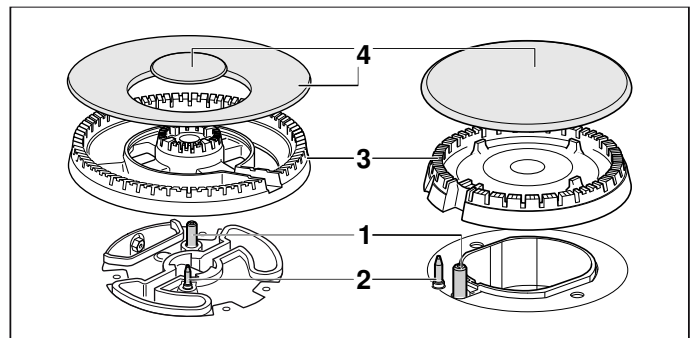

Elementi

1	Candela di accensione
2	Termocoppia
3	Coppetta bruciatore
4	Coperchio bruciatore

Accessori

Secondo il modello, il piano di cottura può includere i seguenti accessori. Questi accessori possono essere acquistati anche presso il Servizio Tecnico.

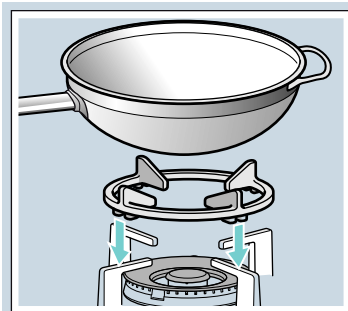

Adattatore wok

Da usare solo con pentole con il fondo concavo, piastre e tegami sul bruciatore wok.

Per prolungare la durata utile dell'apparecchio, si consiglia di utilizzare l'adattatore wok.

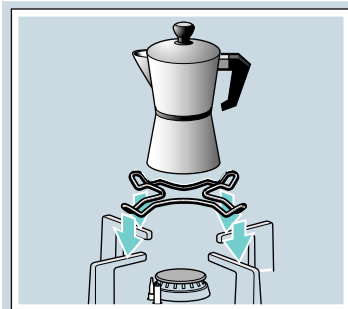

Supporto supplementare per caffettiera moka

Da usare solo con stoviglie con diametro del fondo inferiore a 12 cm sul bruciatore più piccolo.

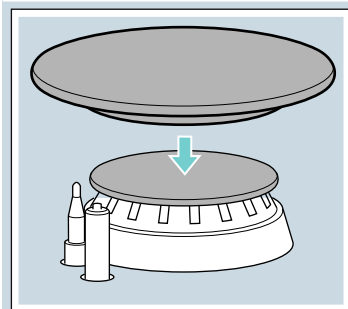

Simmer Cap

Coperchio adatto esclusivamente alla cottura a potenza minima. Per l'utilizzo, è necessario posizionare il coperchio Simmer Cap sul coperchio del bruciatore ausiliario.

Codice

HZ298107 Adattatore wok: griglia di ghisa (4-5 kW)

HZ298114 Supporto supplementare per caffettiera moka

HZ211310 Simmer Cap

Il costruttore declina ogni responsabilità se non si utilizzano o si utilizzano in modo non corretto questi accessori.

Bruciatori a gas

Attivazione manuale

1. Premere la manopola di comando del bruciatore selezionato e ruotarla verso sinistra fino al livello di potenza massimo.
2. Avvicinare un accenditore o una fiamma (accendino, fiammifero, ecc.) al bruciatore.

Accensione automatica

Se il piano di cottura dispone di un'accensione automatica (candelette di accensione):

1. Premere la manopola di comando del bruciatore selezionato e ruotarla verso sinistra fino al livello di potenza massimo. Mentre si tiene premuta la manopola di comando vengono prodotte scintille su tutti i bruciatori. Il bruciatore si accende.
2. Rilasciare la manopola di comando.
3. Ruotare la manopola di comando nella posizione desiderata.

Se l'accensione non avviene, disattivare il bruciatore e ripetere i passaggi descritti in precedenza. Questa volta tenere premuta la manopola di comando più a lungo (fino a 10 secondi).

⚠️ Avviso – Pericolo di esplosione!

Se il bruciatore non si accende dopo 15 secondi, chiudere la manopola di comando e aprire la porta o la finestra del locale. Attendere almeno un minuto prima di riaccendere il bruciatore.

Avvertenza: Accertarsi che la pulizia sia massima. Se le candelette di accensione sono otturate, è possibile che l'accensione fallisca. Pulire regolarmente le candelette di accensione con una piccola spugna non metallica. Evitare urti violenti sulle candelette di accensione.

Sistema di sicurezza

Il piano di cottura dispone di un sistema di sicurezza (termocoppia) che impedisce il passaggio del gas in caso di spegnimento accidentale dei bruciatori.

Per garantire che questo dispositivo sia attivo:

1. Accendere il bruciatore come di consueto.
2. Dopo l'accensione della fiamma, non rilasciare la manopola e mantenerla saldamente premuta per 4 secondi.

Spegnere un bruciatore

Ruotare la manopola corrispondente verso destra, portandola in posizione 0.

Qualche secondo dopo lo spegnimento del bruciatore, viene emesso un suono (colpo secco). Non si tratta di un'anomalia, significa solo che la sicurezza si è disattivata.

Avvertenze

Durante il funzionamento, è normale che il bruciatore emetta un lieve sibilo.

È normale che l'apparecchio nuovo, quando utilizzato le prime volte, sprigioni degli odori. Questo fenomeno non è indice di rischi o di anomalie di funzionamento ed è destinato a scomparire.

Una fiamma di color arancione è normale. Questo colore si deve alla presenza di polvere nell'ambiente, a liquidi versati, ecc.

In caso di spegnimento accidentale delle fiamme del bruciatore, chiudere la manopola del bruciatore e non cercare di riaccenderlo per almeno 1 minuto.

Tabelle e consigli

Recipienti adeguati

Bruciatori	Diametro minimo della stoviglia	Diametro massimo della stoviglia
Bruciatore wok	22 cm	30 cm
Bruciatore rapido	22 cm	26 cm
Bruciatore standard	14 cm	20 cm
Bruciatore piccolo	12 cm	16 cm

Attenzione!

Per evitare danni all'apparecchio, in caso di cottura con piastre o tegami utilizzare sempre l'adattatore wok. → *Pagina 26*

Avvertenze per l'uso

I seguenti consigli consentono di risparmiare energia e di non danneggiare i recipienti:

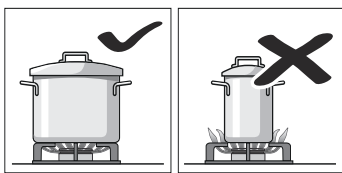

Utilizzare recipienti di dimensioni adeguate a ogni bruciatore. Non usare recipienti piccoli su bruciatori grandi. La fiamma non deve toccare le pareti laterali del recipiente.

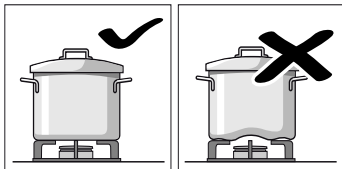

Evitare recipienti deformati che non risultino perfettamente stabili sul piano di cottura. I recipienti potrebbero capovolgarsi. Utilizzare solo recipienti con base piatta e spessa.

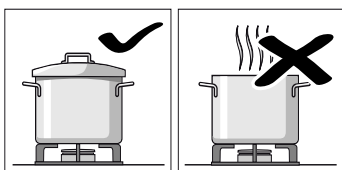

Non cucinare senza coperchio o con il coperchio spostato. Parte dell'energia si disperderebbe.

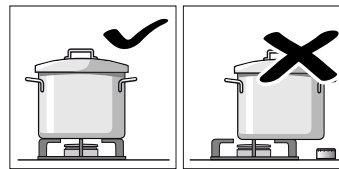

Collocare il recipiente al centro del bruciatore. In caso contrario, potrebbe rovesciarsi.

Non collocare i recipienti grandi sui bruciatori vicini alle manopole. Queste possono subire danni a causa dell'eccessiva temperatura.

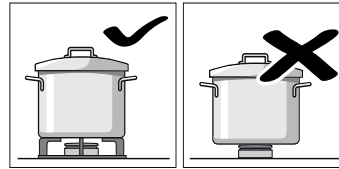

Collocare i recipienti sopra le griglie, mai direttamente sul bruciatore.

Prima di utilizzarli, verificare che griglie e coperchi dei bruciatori siano ben collocati.

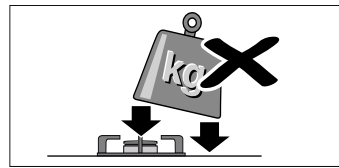

Manipolare con cautela i recipienti sul piano di cottura.

Fare attenzione a non urtare il piano di cottura e non appoggiarvi pesi eccessivi.

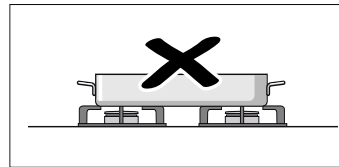

Non usare due bruciatori o fonti di calore per un solo recipiente.

Evitare di usare piastre, casseruole di terracotta, ecc. per periodi prolungati alla massima potenza.

Tabella di cottura



La seguente tabella contiene i livelli di cottura ottimali e i tempi di cottura per le diverse pietanze. Le indicazioni mostrano i valori di riferimento per quattro persone.

I tempi di cottura e i livelli di cottura dipendono dal tipo, dal peso e dalla qualità delle pietanze e dal materiale della stoviglia. Pertanto potrebbero esistere delle discrepanze.







Utilizzare sempre la stoviglia della dimensione corrispondente e posizionarla al centro sul bruciatore. Controllare le informazioni sul diametro della stoviglia. → *"Recipienti adeguati"*

Informazioni sulla tabella

La preparazione di ciascuna pietanza è composta da una o due fasi. Ciascuna fase contiene informazioni circa:

-  Metodo di cottura
-  Livello di cottura
-  Durata in minuti







Metodi di cottura indicati nella tabella

-  Portare a cottura
-  Proseguimento della cottura
-  Creare la pressione nella pentola a pressione
-  Mantenere la pressione nella pentola a pressione
-  Rosolatura a fuoco vivace
-  Rosolatura a fuoco lento
-  Fondere, sciogliere
- * Senza coperchio
- ** Mescolare continuamente

Avvertenza: Questi simboli non si trovano sull'apparecchio. Fungono da suggerimento per i diversi metodi di cottura.

Nella tabella si trovano le indicazioni per la preparazione di pietanze sui diversi bruciatori. L'opzione consigliata riguarda il primo bruciatore. Nella panoramica modelli vengono descritti tutti i bruciatori del piano di cottura. → *Pagina 2*

Esempio:









Piantana Bruciatori	Tempo totale in min.	Fase 1			Fase 2		
Minestre, vellutate							
Zuppa di pesce							
Rapido	12-17		8	7-9		1 5-8	
Standard	17-22		8	11-13		1 6-9	
Wok	10-15		9	6-8		4 4-7	





















































Questo esempio mostra la preparazione della zuppa di pesce con l'ausilio del bruciatore rapido, del bruciatore standard e del bruciatore per wok.



















































Con il bruciatore rapido (opzione consigliata), il tempo di cottura totale è compreso tra 12 e 17 minuti.











































- Fase 1: portare a cottura. Utilizzare il livello 8 per 7-9 minuti.
- Fase 2: proseguimento della cottura. Al livello di cottura 1 cambiare per 5-8 minuti.

Se si utilizza uno degli altri bruciatori consigliati, procedere allo stesso modo.

Piantana Bruciatori	Tempo totale in min.	Fase 1			Fase 2		
Minestre, vellutate							
Zuppa di pesce							
Rapido	12-17		8	7-9		1 5-8	
Standard	17-22		8	11-13		1 6-9	
Wok	10-15		9	6-8		4 4-7	
Vellutata di zucca, zuppa Borsch							
Rapido	30-35		9	10-12		5 20-23	
Standard	45-50		9	15-17		6 30-33	
Wok	25-30		9	8-10		2 17-20	

Piantana Bruciatori	Tempo totale in min.	Fase 1			Fase 2		
Minestrone (zuppa di verdure)							
Rapido	47-52		9	10-12		5 37-40	
Standard	57-62		9	10-12		6 47-50	
Wok	43-48		8	8-10		3 35-38	
Pasta e riso							
Spaghetti							
Rapido	18-22	 *	9	8-10		6 10-12	
Standard	20-24	 *	9	10-12		7 10-12	
Wok	18-22	 *	8	8-10		6 10-12	
Riso							
Rapido	17-22		9	5-7		2 12-15	
Standard	18-23		9	7-9		6 11-14	
Wok	15-20		8	4-6		2 11-14	
Ravioli							
Rapido	9-14		9	4-6		6 5-8	
Standard	17-22		8	12-14		8 5-8	
Wok	10-15		8	5-7		8 5-8	
Verdure e legumi							
Patate bollite (purea, insalata di patate)							
Rapido	23-28		9	8-10		5 15-18	
Standard	25-30		9	10-12		6 15-18	
Wok	25-30		7	11-13		5 14-17	
Hummus (purea di ceci)							
Rapido	50-55		9	10-12		4 40-43	
Standard	52-57		9	12-14		5 40-43	
Wok	47-52		7	10-12		5 37-40	
Lenticchie							
Rapido	40-45		9	8-10		9 32-35	
Standard	50-55		9	18-20		6 32-35	
Wok	45-50		6	20-22		4 25-28	
Verdure fritte							
Rapido	12-17	 *	7	6-8	 *	6 6-9	
Standard	15-20	 *	8	8-10	 *	7 7-10	
Wok	11-16	 *	7	6-8	 *	5 5-8	
Verdure fresche saltate **							
Wok	6-8	 *	9	6-8			
Rapido	6-8	 *	9	6-8			
Patate fritte							
Wok	15-20	 *	7	15-20			
Rapido	15-20	 *	9	15-20			
Standard	25-30	 *	9	25-30			

Pietanza Bruciatori	Tempo totale in min.	Fase 1	Fase 2
		  	  
Uova			
Shakshuka			
Standard	15-20	 9 10-12	 4 5-8
Rapido	13-18	 8 7-9	 3 6-9
Wok	15-20	 6 11-13	 4 4-7
Omelette (1 porz.)			
Standard	3-5	 * 8 3-5	
Rapido	2-4	 * 9 2-4	
Wok	2-4	 * 5 2-4	
Tortilla spagnola			
Rapido	25-30	 * 9 25-30	
Wok	18-23	 * 9 18-23	
Salse			
Besciamella**			
Ridotto	10-15	 * 6 2-4	 * 6 8-11
Standard	10-15	 * 5 2-4	 * 5 8-11
Wok	3-8	 * 5 1-2	 * 5 2-6
Salsa con formaggio erborinato**			
Ridotto	4-6	 * 7 4-6	
Standard	3-5	 * 7 3-5	
Rapido	3-5	 * 5 3-5	
Salsa napoletana			
Standard	18-23	 * 6 2-4	 * 4 16-19
Wok	13-18	 * 7 1-3	 * 5 12-15
Rapido	15-20	 * 8 1-3	 * 6 14-17
Salsa carbonara			
Standard	10-15	 * 6 5-7	 * 3 5-8
Rapido	8-13	 * 5 4-6	 * 3 4-7
Ridotto	10-15	 * 9 5-7	 * 5 5-8
Pesce			
Merluzzo alla romana			
Rapido	5-10	 * 8 5-10	
Standard	8-13	 * 9 8-13	
Wok	4-9	 * 6 4-9	
Salmone al forno			
Rapido	5-10	 * 7 2-4	 1 3-6
Standard	5-10	 * 8 2-4	 1 3-6
Wok	7-12	 * 8 2-4	 1 5-8
Frutti di mare			
Rapido	5-7	 9 5-7	
Wok	4-6	 9 4-6	
Standard	10-12	 9 10-12	

Pietanza Bruciatori	Tempo totale in min.	Fase 1	Fase 2
		  	  
Carne			
Petto d'anatra (1 pezzo)			
Standard	6-8	 * 7 6-8	
Rapido	9-11	 * 7 9-11	
Wok	6-8	 * 5 6-8	
Filetto di manzo alla Stroganoff			
Rapido	8-13	 * 9 8-13	
Wok	5-10	 * 8 5-10	
Standard	12-17	 * 9 12-17	
Cotoletta di pollo (8 filetti di petto di pollo)			
Rapido	7-12	 * 9 2-4	 * 6 5-8
Wok	7-12	 * 9 2-4	 * 6 5-8
Standard	7-12	 * 9 7-12	
Carne trita (pasticcio di carne, polpette, ragù alla bolognese)			
Rapido	15-20	 * 8 15-20	
Standard	20-25	 * 9 20-25	
Wok	15-20	 * 6 15-20	
Cibi pronti			
Crocchette surgelate (16 pezzi)			
Bastoncini di pesce surgelati (12 pezzi)			
Rapido	6-10	 8 6-10	
Wok	5-9	 8 5-9	
Standard	8-12	 8 8-12	
Salsicce (12 pezzi)			
Rapido	5-10	 9 1-3	 7 4-7
Standard	7-12	 9 7-12	
Wok	5-10	 9 1-3	 7 4-7
Würstel lessi (12 pezzi)			
Standard	8-13	 9 8-13	
Wok	9-14	 4 9-14	
Rapido	7-12	 7 7-12	
Hamburger (4 pezzi)			
Rapido	4-9	 * 9 1-3	 * 7 3-6
Wok	4-9	 * 9 1-3	 * 7 3-6
Standard	5-10	 * 9 1-3	 * 8 4-7
Verdure congelate**			
Rapido	7-12	 * 9 7-12	
Wok	5-10	 * 9 5-10	
Standard	12-17	 * 9 12-17	
Pizza (20 cm di diametro)			
Wok	4-8	 1 4-8	
Rapido	16-20	 1 16-20	
Standard	20-25	 1 20-25	

Pietanza Bruciatori	Tempo totale in min.	Fase 1	Fase 2
Dessert			
Budino di riso**			
Standard	30-35	* 8 9-11	* 4 21-24
Ridotto	40-45	* 9 12-14	* 2 28-31
Wok	35-40	* 7 11-13	* 1 24-27
Cioccolato al latte			
Ridotto	10-14	* 1 10-14	
Standard	16-20	* 1 16-20	
Crêpes (4 pezzi)			
Rapido	17-22	* 7 1-3	* 5 16-19
Wok	8-13	* 7 1-3	* 4 7-10
Standard	20-25	* 8 1-3	* 6 19-22
Budino di pane			
Rapido	25-30	9 10-12	6 15-18
Wok	23-28	9 8-10	7 15-18
Standard	27-32	9 10-12	7 17-20
Budino spagnolo**			
Rapido	3-8	* 5 3-8	
Standard	8-13	* 5 8-13	
Wok	3-8	* 2 3-8	
Torta morbida (a bagnomaria)			
Rapido	35-40	9 35-40	
Wok	40-45	9 40-45	
Standard	45-50	9 45-50	

Consigli di cottura

- Per la preparazione di vellutate e legumi utilizzare la pentola a pressione. Il tempo di cottura viene sensibilmente ridotto. Se si utilizza una pentola a pressione, seguire le istruzioni del produttore.
- Durante la cottura di patate e riso mettere sempre un coperchio. Il tempo di cottura viene sensibilmente ridotto.
- Per pietanze da cuocere in padella, riscaldare innanzitutto l'olio. Qualora sia già iniziata la cottura, mantenere la temperatura costante, in caso di necessità è invece possibile adattare il livello di cottura. Per la preparazione di più pietanze attendere finché la temperatura di cottura viene di nuovo raggiunta. Girare costantemente le pietanze.

Pulizia e manutenzione

Pulizia

Una volta raffreddato l'apparecchio, pulirlo con acqua e sapone, utilizzando una spugna.

Dopo ogni uso, pulire la superficie dei rispettivi elementi del bruciatore quando si è raffreddato. Se si lasciano residui (alimenti ricotti, gocce di grasso, ecc.), per piccoli che siano, si incrosteranno sulla superficie e saranno più difficili da eliminare. Per avere la giusta fiamma, è necessario che i fori e le fessure siano puliti.

Il movimento di qualche recipiente potrebbe lasciare residui metallici sulle griglie.

Pulire i bruciatori e le griglie con acqua e sapone e strofinare con una spazzola non metallica.

Se le griglie sono dotate di piedini di gomma, fare attenzione durante le operazioni di pulizia. I piedini possono staccarsi e la griglia può rigare il piano di cottura.

Asciugare sempre e perfettamente i bruciatori e le griglie. La presenza di gocce d'acqua o di zone umide all'inizio della cottura può deteriorare lo smalto.

Dopo aver pulito e asciugato i bruciatori, assicurarsi che i coperchi siano ben collocati sul diffusore.

Attenzione!

- Per la pulizia dell'apparecchio non rimuovere gli elementi di comando. Il sopravvenire di umidità potrebbe danneggiare l'apparecchio.
- Non utilizzare apparecchi di pulizia a vapore. Il piano di cottura potrebbe danneggiarsi.
- Non utilizzare mai prodotti abrasivi, pagliette di acciaio, oggetti taglienti, coltelli, ecc. per staccare residui di cibo induriti dal piano di cottura.
- Non utilizzare coltelli, raschietti o simili per pulire le giunzioni tra la lastra di vetro e gli elementi decorativi dei bruciatori, i profili metallici o i pannelli di vetro e alluminio, se presenti.

Manutenzione

Pulire immediatamente i liquidi che fuoriescono. In tal modo, si evita che i residui di cibo restino attaccati al piano di cottura e si risparmiano sforzi inutili.

Non trascinare i recipienti sul vetro, per evitare di graffiarlo. Analogamente, fare in modo che non cadano oggetti duri o appuntiti sul vetro. Non colpire il piano di cottura su nessuno dei suoi spigoli.

I granelli di terra (provenienti, ad esempio, dalla pulizia di ortaggi e verdure) graffiano la superficie del vetro.

Le eventuali fuoriuscite di zucchero fuso o di alimenti ad elevato contenuto di zucchero devono essere immediatamente eliminate dalla zona di cottura con l'ausilio del raschietto per vetro.

Malf funzionamento, che fare?

In alcuni casi è possibile eliminare facilmente le anomalie eventualmente insorte. Prima di rivolgersi al servizio di assistenza tecnica, prestare attenzione alle seguenti avvertenze:

Anomalia	Possibile causa	Soluzione
Guasto elettrico generale.	Fusibile difettoso.	Controllare il fusibile nella scatola generale dei fusibili e, all'occorrenza, sostituirlo.
	È possibile che sia saltato l'interruttore automatico o un differenziale.	Nel quadro elettrico generale, controllare se è saltato l'interruttore automatico o un differenziale.
L'accensione automatica non funziona.	È possibile che vi siano residui di cibo o di prodotti di pulizia fra le candele e i bruciatori.	Lo spazio tra la candela e il bruciatore deve essere pulito.
	I bruciatori sono bagnati.	Asciugare con cura i coperchi dei bruciatori.
	I coperchi dei bruciatori sono collocati in modo non corretto.	Verificare che i coperchi dei bruciatori siano ben collocati.
	L'apparecchio non è collegato a terra, non è collegato correttamente o la presa di terra è difettosa.	Contattare l'installatore elettrico.
La fiamma del bruciatore non è uniforme.	Gli elementi del bruciatore non sono posizionati in modo corretto.	Sistemare i pezzi in maniera corretta sul bruciatore corrispondente.
	Le fessure del bruciatore sono sporche.	Pulire le fessure del bruciatore.
Il flusso di gas sembra anomalo o il gas non fuoriesce.	Il passaggio del gas è chiuso da chiavi intermedie.	Aprire le eventuali chiavi intermedie.
	Se il gas proviene da una bombola, verificare che non sia vuota.	Cambiare la bombola.
Nella cucina c'è odore di gas.	Qualche rubinetto è aperto.	Chiudere i rubinetti.
	Il raccordo di collegamento della bombola non è serrato correttamente.	Verificare che il raccordo sia in perfette condizioni.
	Possibile perdita di gas.	Chiudere il rubinetto generale del gas, aerare il locale e contattare immediatamente un tecnico autorizzato per la revisione e la certificazione dell'impianto. Prima dell'uso controllare che non ci siano perdite di gas nell'impianto o nell'apparecchio.
Il bruciatore si spegne immediatamente quando si rilascia la manopola.	La manopola non è stata premuta per il tempo sufficiente.	Una volta acceso il bruciatore, tenere premuta la manopola qualche secondo in più.
	Le fessure del bruciatore sono sporche.	Pulire le fessure del bruciatore.

Servizio assistenza clienti

In caso di richiesta di intervento del nostro Servizio Tecnico, fornire il codice del prodotto (E-Nr.) e il codice di fabbricazione (FD) dell'apparecchio. Queste informazioni sono riportate sulla targa identificativa, situata nella parte inferiore del piano di cottura, e sull'etichetta del manuale d'uso.

Trovate i dati di contatto di tutti i paesi nell'accluso elenco dei centri di assistenza clienti.

Ordine di riparazione e consulenza in caso di guasti

I 800-018346

Linea verde

CH 0848 840 040

Fidatevi della competenza del Costruttore. In questo modo avrete la garanzia di una riparazione effettuata da tecnici qualificati del servizio assistenza e con pezzi di ricambio originali per il vostro apparecchio.

Condizioni di garanzia

Se, contrariamente alle nostre aspettative, l'apparecchio presentasse qualche difetto o non rispondesse alle esigenze di qualità previste, le chiediamo di comunicarcelo al più presto. Perché la garanzia sia valida, l'apparecchio non deve essere manomesso o usato impropriamente.

Le condizioni di garanzia applicabili sono quelle stabilite dalla rappresentanza della nostra azienda nel paese in cui è stato effettuato l'acquisto. Informazioni dettagliate sono disponibili presso i punti vendita. Per usufruire della garanzia, è necessario presentare lo scontrino fiscale.

L'azienda si riserva il diritto di apportare modifiche.

Tutela dell'ambiente

Se sulla targhetta d'identificazione dell'apparecchio si trova il simbolo , prestare attenzione alle seguenti avvertenze.

Smaltimento ecocompatibile

Si prega di smaltire le confezioni nel rispetto dell'ambiente.



Questo apparecchio dispone di contrassegno ai sensi della direttiva europea 2012/19/UE in materia di apparecchi elettrici ed elettronici (waste electrical and electronic equipment - WEEE).

Questa direttiva definisce le norme per la raccolta e il riciclaggio degli apparecchi dismessi valide su tutto il territorio dell'Unione Europea.

L'imballaggio dell'apparecchio è costituito dagli elementi strettamente necessari a garantire una efficace protezione durante il trasporto. I materiali di imballaggio sono totalmente riciclabili e ridotto, quindi, è il loro impatto ambientale. La invitiamo a contribuire alla salvaguardia dell'ambiente tenendo conto anche dei seguenti consigli:

- smaltire gli elementi dell'imballaggio nei corrispondenti contenitori di riciclaggio,
- prima di consegnare il vecchio apparecchio alla piattaforma di raccolta, renderlo inutilizzabile. Presso i competenti uffici locali, informarsi sul più vicino centro di raccolta di materiali riciclabili per conferire il proprio apparecchio,
- non buttare l'olio usato nel lavandino. Conservarlo in un recipiente chiuso e consegnarlo a un centro di raccolta o, se questo non fosse possibile, gettarlo nella spazzatura (in tal modo, verrà smaltito in una discarica controllata; pur non trattandosi della migliore soluzione, si evita in questo modo la contaminazione dell'acqua).

Inhoudsopgave

	Gebruik volgens de voorschriften	33
	Belangrijke veiligheidsvoorschriften	34
	Het apparaat leren kennen	35
	Bedieningselementen en branders.	35
	Toebehoren	36
	Gasbranders	36
	Met de hand inschakelen.	36
	Automatische ontsteking	36
	Veiligheidssysteem.	36
	Een brander uitdoven.	36
	Waarschuwingen	36
	Tabellen en tips	37
	Geschikte pannen	37
	Waarschuwingen voor het gebruik.	37
	Bereidingstabel	37
	Reinigen en onderhouden	40
	Reiniging	40
	Onderhoud.	40
	Wat te doen bij storingen?	41
	Servicedienst	42
	Garantievoorwaarden.	42
	Milieubescherming	42
	Milieuvriendelijk afvoeren.	42

Meer informatie over producten, accessoires, onderdelen en diensten vindt u op het internet: www.siemens-home.com en in de online-shop: www.siemens-eshop.com

Gebruik volgens de voorschriften

Lees deze instructies aandachtig. Alleen dan kunt u uw apparaat op een juiste en veilige manier gebruiken. Bewaar de gebruiks- en installatie-instructies en overhandig deze met het apparaat indien het van eigenaar wisselt.

De fabrikant is vrij van elke verantwoordelijkheid, indien de beschikkingen van deze handleiding niet nageleefd worden.

De afbeeldingen die bij deze aanwijzingen staan afgedrukt zijn slechts ter oriëntatie.

Haal het apparaat niet uit de beschermende verpakking, tot het moment van de inbouw. Indien u schade waarneemt aan het apparaat, sluit het dan niet aan. Neem contact op met onze Technische Dienst.

Dit apparaat behoort tot klasse 3, volgens de norm EN 30-1-1 voor gasapparaten: apparaat ingebouwd in een meubel.

Zorg, voordat uw nieuwe kookplaat geïnstalleerd wordt, dat de installatie uitgevoerd wordt volgens het installatievoorschrift.

Dit apparaat mag niet worden geïnstalleerd in jachten of caravans.

Dit apparaat mag alleen gebruikt worden in voldoende geventileerde ruimtes.

Dit apparaat is niet bestemd voor gebruik met een externe tijdschakelklok of een afstandbediening.

Alle werkzaamheden betreffende installatie, afstelling en aanpassing aan een ander soort gas moeten worden uitgevoerd door een bekwaam installateur, waarbij alle toepasbare normen en wetgeving en de voorschriften van de lokale gas- en elektriciteitsmaatschappijen moeten worden nageleefd. Er wordt met name gelet op de voorschriften met betrekking tot ventilatie.

Dit apparaat is vanuit de fabriek aangepast aan het soort gas dat vermeld staat op het gegevensplaatje. Raadpleeg het installatievoorschrift indien dat gewijzigd moet worden. Het wordt aanbevolen onze Technische dienst te bellen voor de aanpassing aan een ander soort gas.

Dit apparaat is enkel ontworpen voor huishoudelijk gebruik. Commercieel of professioneel gebruik hiervan is niet toegestaan. Gebruik het apparaat enkel om te koken, nooit als verwarming. De garantie is alleen geldig als het apparaat gebruikt wordt voor het doel waarvoor het ontworpen is.

Dit apparaat is bestemd voor gebruik tot op hoogten van maximaal 2.000 meter boven zeeniveau.

Zorg ervoor dat er tijdens het gebruik van het apparaat altijd toezicht is.

Gebruik geen deksels of beschermingsbarrières voor kinderen die niet aanbevolen worden door de fabrikant van de kookplaat. Ze kunnen ongevallen veroorzaken, bv. wegens oververhitting, ontsteking of loskomen van materiaaldeeltjes.

Dit toestel kan worden gebruikt door kinderen vanaf 8 jaar en door personen met beperkte fysieke, sensorische of geestelijke vermogens of personen die gebrek aan kennis of ervaring hebben, wanneer zij onder toezicht staan van een persoon die verantwoordelijk is voor hun veiligheid of geleerd hebben het op een veilige manier te gebruiken en zich bewust zijn van de risico's die het gebruik van het toestel met zich meebrengt.

Kinderen mogen niet met het apparaat spelen. Reiniging en onderhoud van het toestel mogen niet worden uitgevoerd door kinderen, tenzij zij 8 jaar of ouder zijn en onder toezicht staan.

Zorg ervoor dat kinderen die jonger zijn dan 8 jaar uit de buurt blijven van het toestel of de aansluitkabel.

Belangrijke veiligheidsvoorschriften

Waarschuwing – Deflagratiegevaar!

Ophoping van onverbrand gas in een afgesloten ruimte veroorzaakt deflagratiegevaar. Stel het apparaat niet bloot aan luchtstromen. De branders zouden kunnen uitgaan. Lees de aanwijzingen en waarschuwingen omtrent de werking van gasbranders aandachtig door.

Waarschuwing – Risico op vergiftiging!

Het gebruik van een gaskookapparaat veroorzaakt warmte, vocht en verbrandingsproducten in de ruimte waar het geïnstalleerd is. Zorg voor een goede ventilatie in de keuken, met name wanneer kookplaat aan staat: laat de natuurlijke ventilatieopeningen open of installeer een voorziening voor mechanische ventilatie (afzuigkap). Bij intensief en langdurig gebruik van het apparaat kan extra of doeltreffendere ventilatie nodig zijn: zet een raam open of verhoog het vermogen van de mechanische ventilatie.

Waarschuwing – Gevaar voor brandwonden!

- De kookzones en nabijgelegen zones worden zeer heet. Raak de hete oppervlakken nooit aan. Houd kinderen jonger dan 8 jaar uit de buurt.
- Wanneer de fles voor vloeibaar gas niet loodrecht staat, kan het vloeibare propaan/ butaan/ in het apparaat terechtkomen. Er kunnen dan heftige steekvlammen bij de branders optreden. Onderdelen kunnen beschadigd raken en in de loop van de tijd ondicht worden, waardoor er op een ongecontroleerde manier gas ontsnapt. Deze beide oorzaken kunnen leiden tot verbrandingen. Flessen voor vloeibaar gas altijd in een loodrechte stand houden.

Waarschuwing – Brandgevaar!

- De kookzones worden zeer heet. Leg nooit ontvlambare voorwerpen op de kookplaat. Bewaar geen voorwerpen op de kookplaat.
- Sla geen corrosieve chemische producten, stoom, ontvlambare materialen of niet-voedingsmiddelen op onder dit huishoudelijk apparaat of in de buurt daarvan.

- Oververhit vet of olie vat gemakkelijk vlam. Ga nooit weg terwijl u vet of olie verhit. Indien dit vlam vat, doof het vuur dan niet met water. Doe een deksel op de pan om het vuur te doven en zet de kookzone uit.

⚠ Waarschuwing – Gevaar voor letsel!

- Barsten of breuken in de glasplaat zijn gevaarlijk. Alle branders en elektrische verwarmingselementen onmiddellijk uitschakelen. De netstekker uit het stopcontact halen of de zekering in de meterkast uitschakelen. Gastoevoer afsluiten. Het oppervlak van het apparaat niet aanraken. Een defect toestel nooit inschakelen. Contact opnemen met de servicedienst.
- Plotselinge temperatuurwisselingen kunnen veroorzaken dat het glas breekt. Vermijd luchtstromen en het morsen van koude vloeistof terwijl de kookplaat gebruikt wordt.
- Pannen die beschadigd zijn, een ongeschikte afmeting hebben, buiten de randen van de kookplaat uitkomen of niet goed geplaatst zijn kunnen ernstig letsel veroorzaken. Neem de tips en waarschuwingen omtrent pannen in acht.
- Sluit bij storing de stroom- en gastoevoer van het apparaat af. Bel voor de reparatie onze Technische Dienst.
- Manipuleer de binnenzijde van het apparaat niet. Bel indien nodig onze Technische Dienst.
- Indien een van de knoppen niet kan worden gedraaid, forceer deze niet. Bel onmiddellijk met de Technische dienst voor reparatie of vervanging daarvan.

⚠ Waarschuwing – Gevaar voor elektrische schokken!

- Gebruik geen stoomreinigers om het apparaat te reinigen.
- Barsten of breuken in de glasplaat kunnen elektrische schokken veroorzaken. Zekering in de meterkast uitschakelen. Contact opnemen met de klantenservice.

Het apparaat leren kennen

In het modeloverzicht vindt u uw apparaat met de brandervermogens. → Blz. 2

Bedieningselementen en branders

Bij elke bedieningsknop wordt de bijbehorende brander aangegeven. Met de bedieningsknoppen kunt u, in overeenstemming met de verschillende posities, het benodigde vermogen instellen tussen de maximale en minimale waarden. Probeer nooit om van stand 0 direct naar stand 1 of om van stand 1 naar stand 0 te gaan.

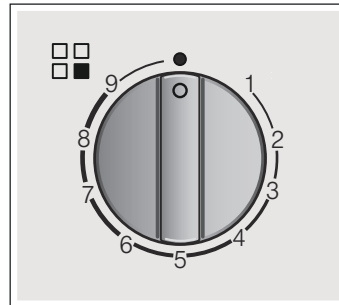

Indicaties

	Brander die m.b.v. de bedieningsknop wordt geregeld
	Uitgeschakelde brander
9	Hoogste vermogensstand en elektrische ontsteking
1	Laagste vermogensstand

Voor een correcte werking van het apparaat is het noodzakelijk om te controleren of de roosters en alle delen van de branders juist geplaatst zijn. Verwissel de deksels van de branders niet.

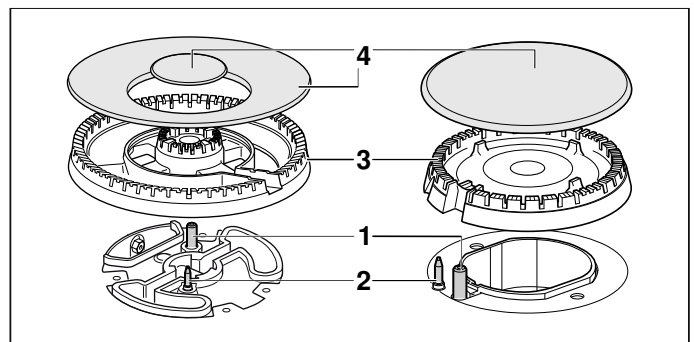

Elementen

1	Ontstekingskaars
2	Thermo-element
3	Branderkelk
4	Branderdeksel

Toebehoren

Afhankelijk van het model, kan de kookplaat de onderstaande toebehoren bevatten. Deze kunnen ook worden aangeschaft bij de technische dienst.

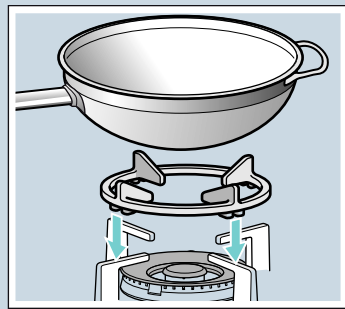

Wok-opzetting

Alleen voor gebruik van kookgerei met gewelfde bodem, bak- en braadplaten en pannen van aardewerk op wok-branders.

Ter verlenging van de levensduur van het apparaat wordt het aanbevolen de wok-opzetting te gebruiken.

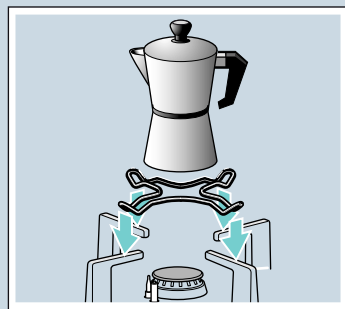

Extra houder voor espressokoker

Alleen voor gebruik van kookgerei met een bodemdiameter van minder dan 12 cm op de kleinste brander.

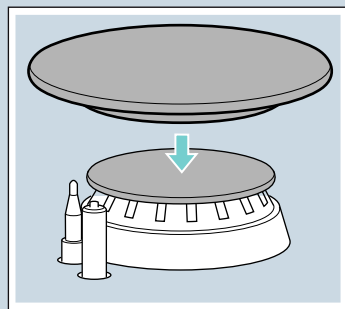

Simmer cap

Deksel uitsluitend bedoeld om op de minimumstand te koken. Voor het gebruik daarvan moet de Simmer Cap deksel op de deksel van de hulpbrander worden geplaatst.

Code

HZ298107 Wok-opzetting: rooster in gietijzer (4-5 kW)

HZ298114 Extra houder voor espressokoker

HZ211310 Simmer Cap

De fabrikant neemt geen verantwoordelijkheid op zich wanneer deze toebehoren niet of verkeerd gebruikt worden.

Gasbranders

Met de hand inschakelen

1. Druk op de bedieningsknop van de gekozen brander en draai hem naar links tot de hoogste vermogensstand.
2. Houd een aansteker of een vlam (van een lucifer bijv.) bij de brander.

Automatische ontsteking

Wanneer uw kookplaat beschikt over een automatische ontsteking (ontstekingskaarsen):

1. Druk op de bedieningsknop van de gekozen brander en draai hem naar links tot de hoogste vermogensstand. Terwijl u de bedieningsknop ingedrukt houdt, verschijnen er vonken bij alle branders. De brander ontsteekt.
2. Laat de bedieningsknop los.
3. Draai de bedieningsknop in de gewenste stand.

Vindt er geen ontsteking plaats, zet de brander dan uit en herhaal de hiervoor beschreven stappen. Houd de bedieningsknop dit keer langer ingedrukt (tot 10 seconden).

⚠ Waarschuwing – Ontploffingsgevaar!

Ontsteekt de brander niet na 15 seconden, schakel de bedieningsknop dan uit en open de deur of het raam van de ruimte. Wacht nog minstens een minuut voordat u de brander opnieuw ontsteekt.

Aanwijzing: Let er goed op dat de ontstekingskaarsen schoon zijn. Zijn ze vervuild, dan kan dit van invloed zijn op het ontbranden. Maak de ontstekingskaarsen regelmatig schoon met een kleine borstel die niet van metaal is. Let erop dat er geen heftige stoten op de ontstekingskaarsen worden uitgeoefend.

Veiligheidssysteem

Uw kookplaat beschikt over een veiligheidssysteem (thermokoppel) dat de gasuitlaat verhindert indien de branders per ongeluk uitgaan.

Om te garanderen dat deze voorziening actief zou zijn:

1. Ontsteek de brander op gewone wijze.
2. Laat de knop niet los, houd deze stevig ingedrukt gedurende 4 seconden nadat de vlam ontstoken is.

Een brander uitdoven

Draai de overeenstemmende knop naar rechts tot stand 0.

Enkele seconden nadat de brander uitgaat, klinkt er een geluid (plof). Dit is geen afwijking, dit betekent dat de veiligheid gedeactiveerd is.

Waarschuwingen

Tijdens de werking van de brander is het normaal dat u een zachte fluittoon hoort.

De eerste keren dat het apparaat gebruikt wordt is het normaal dat er geuren vrijkomen. Dit betekent geen risico noch defecte werking. Deze verdwijnen na verloop van tijd.

Een vlam met een oranje kleur is normaal. Dit komt door de aanwezigheid van stof in de omgeving, gemorste vloeistof, enz.

Mocht de vlam van de brander per ongeluk uitgaan, sluit dan de bedieningsknop van de brander en wacht ten minste 1 minuut alvorens hem weer te proberen aan te steken.

Tabellen en tips

Geschikte pannen

Branders	Minimale diameter van de vorm	Maximale diameter van de vorm
Wok-brander	22 cm	30 cm
Snelbrander	22 cm	26 cm
Halfsnelbrander	14 cm	20 cm
Hulpbrander	12 cm	16 cm

Attentie!

Ter voorkoming van schade aan het apparaat dient tijdens de bereiding op bak- en braadplaten of in pannen van aardewerk altijd de wok-opzetting te worden gebruikt. → Blz. 36

Waarschuwingen voor het gebruik

Onderstaande raadgevingen helpen u energie te besparen en schade vermijden aan de pannen:

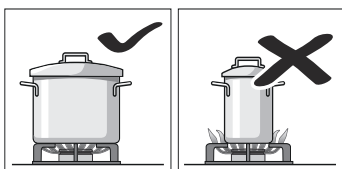

Gebruik pannen met een geschikte maat voor elke brander.
Gebruik geen kleine pannen op grote branders. De vlam mag de zijkanten van de pan niet raken.

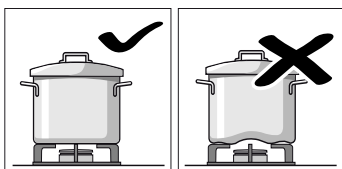

Gebruik geen vervormde pannen die onstabiel staan op de kookplaat. De pannen zouden kunnen kantelen.

Gebruik altijd pannen met een vlakke en dikke bodem.

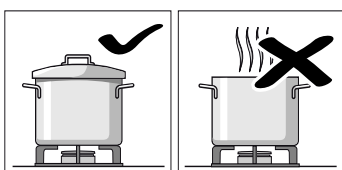

Kook niet zonder deksel of met verschoven deksel. Een deel van de energie gaat verloren.

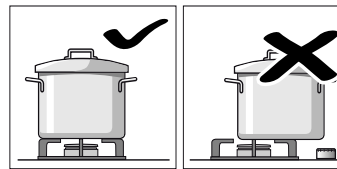

Plaats de pan op het midden van de brander. Zo niet, dan kan deze omvallen.
Plaats geen grote pannen op de branders naast de knoppen. Deze kunnen beschadigd worden wegens te hoge temperatuur.

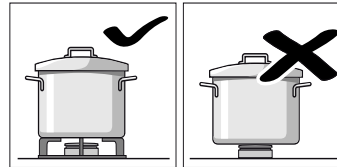

Plaats de pannen op de roosters, nooit rechtstreeks op de brander.
Controleer voor gebruik of de roosters en de branderdekseksels op de juiste wijze zijn geplaatst.

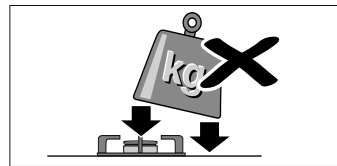

Hanteer de pannen voorzichtig op de kookplaat.
Stoot niet tegen de kookplaat aan, noch plaats hierop te hoge gewichten.

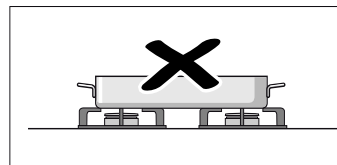

Gebruik geen twee branders of warmtebronnen voor één pan.
Vermijd het gebruik van grillplaten, kookpotten van aardewerk, enz. gedurende lange tijd op het maximumvermogen.

Bereidingstabel



In de volgende tabel staan de optimale kookstanden en bereidingstijden voor verschillende gerechten. Bij de recepten wordt steeds uitgegaan van vier personen.

De bereidingstijden en kookstanden zijn afhankelijk van het soort, het gewicht en de kwaliteit van de gerechten en van het materiaal van het kookgerei. Afwijkingen zijn dan ook mogelijk.







Gebruik altijd kookgerei dat de juiste afmetingen heeft en plaats dit midden op de brander. Lees de informatie over de diameter van het kookgerei. → "Geschikte pannen"

Informatie over de tabel

De bereiding van elk gerecht bestaat uit één of twee stappen. Bij elke stap vindt u informatie over:

-  Bereidingsmethode
-  Kookstand
-  Tijdsduur in minuten













In de tabel opgegeven bereidingsmethoden

-  Opkoken
-  Doorkoken
-  Druk in de snelkookpan opbouwen
-  Druk in de snelkookpan behouden
-  Sterk aanbraden
-  Licht aanbraden
-  Smelten
- * Zonder deksel
- ** Continu roeren

Aanwijzing: Deze symbolen staan niet op het apparaat. Zij dienen ter oriëntatie voor verschillende bereidingsmethoden.

In de tabel vindt u opgaven voor het bereiden van gerechten op verschillende branders. De eerste brander is de aanbevolen optie. In het modeloverzicht worden alle branders van de kookplaat beschreven. → Blz. 2

Voorbeeld:



















Gerecht	Totale tijd in min.	Stap 1			Stap 2		
Branders							
Soepen, crèmesoeppen							
Vissoep							
Snelbrander	12-17		8	7-9		1	5-8
Halfsnelbrander	17-22		8	11-13		1	6-9
Wok-brander	10-15		9	6-8		4	4-7



























































Dit is een voorbeeld van de bereiding van vissoep met behulp van de snelbrander, de normale brander en de wokbrander.

Met de snelbrander (aanbevolen optie) bedraagt de totale bereidingstijd tussen de 12 en 17 minuten.









































- Stap 1: Aan de kook brengen. Kookstand 8 gebruiken gedurende 7-9 minuten.
- Stap 2: Doorkoken Overgaan op kookstand 1 gedurende 5-8 minuten.

Gebruikt u een andere brander dan voorgesteld, ga dan op dezelfde manier te werk.

Gerecht	Totale tijd in min.	Stap 1			Stap 2		
Branders							
Soepen, crèmesoeppen							
Vissoep							
Snelbrander	12-17		8	7-9		1	5-8
Halfsnelbrander	17-22		8	11-13		1	6-9
Wok-brander	10-15		9	6-8		4	4-7
Pompoenroom, borsjt-soep							
Snelbrander	30-35		9	10-12		5	20-23
Halfsnelbrander	45-50		9	15-17		6	30-33
Wok-brander	25-30		9	8-10		2	17-20

Gerecht	Totaletijd in min.	Stap 1			Stap 2		
Branders							
Minestrone (groentesoep)							
Snelbrander	47-52		9	10-12		5	37-40
Halfsnelbrander	57-62		9	10-12		6	47-50
Wok-brander	43-48		8	8-10		3	35-38
Pasta en rijst							
Spaghetti							
Snelbrander	18-22		9	8-10		6	10-12
Halfsnelbrander	20-24		9	10-12		7	10-12
Wok-brander	18-22		8	8-10		6	10-12
Rijst							
Snelbrander	17-22		9	5-7		2	12-15
Halfsnelbrander	18-23		9	7-9		6	11-14
Wok-brander	15-20		8	4-6		2	11-14
Ravioli							
Snelbrander	9-14		9	4-6		6	5-8
Halfsnelbrander	17-22		8	12-14		8	5-8
Wok-brander	10-15		8	5-7		8	5-8
Groente en peulvruchten							
Gekookte aardappelen (puree, aardappelsalade)							
Snelbrander	23-28		9	8-10		5	15-18
Halfsnelbrander	25-30		9	10-12		6	15-18
Wok-brander	25-30		7	11-13		5	14-17
Hummus (gepureerde kikkererwten)							
Snelbrander	50-55		9	10-12		4	40-43
Halfsnelbrander	52-57		9	12-14		5	40-43
Wok-brander	47-52		7	10-12		5	37-40
Linzen							
Snelbrander	40-45		9	8-10		9	32-35
Halfsnelbrander	50-55		9	18-20		6	32-35
Wok-brander	45-50		6	20-22		4	25-28
Gefrituurde groente							
Snelbrander	12-17		7	6-8		6	6-9
Halfsnelbrander	15-20		8	8-10		7	7-10
Wok-brander	11-16		7	6-8		5	5-8
Gesauteerde, verse groente**							
Wok-brander	6-8		9	6-8			
Snelbrander	6-8		9	6-8			
Frites							
Wok-brander	15-20		7	15-20			
Snelbrander	15-20		9	15-20			
Halfsnelbrander	25-30		9	25-30			

Gerecht Branders	Totaletijd in min.	Stap 1		Stap 2	
					
Eieren					
Shakshuka					
Halfsnelbrander	15-20	 9	10-12	 4	5-8
Snelbrander	13-18	 8	7-9	 3	6-9
Wok-brander	15-20	 6	11-13	 4	4-7
Omelet (1 portie)					
Halfsnelbrander	3-5	 * 8	3-5		
Snelbrander	2-4	 * 9	2-4		
Wok-brander	2-4	 * 5	2-4		
Spaanse tortilla					
Snelbrander	25-30	 * 9	25-30		
Wok-brander	18-23	 * 9	18-23		
Sauzen					
Bechamelsaus**					
Hulpbrander	10-15	 * 6	2-4	 * 6	8-11
Halfsnelbrander	10-15	 * 5	2-4	 * 5	8-11
Wok-brander	3-8	 * 5	1-2	 * 5	2-6
Saus met blauwe schimmelkaas**					
Hulpbrander	4-6	 * 7	4-6		
Halfsnelbrander	3-5	 * 7	3-5		
Snelbrander	3-5	 * 5	3-5		
Napoletana-saus					
Halfsnelbrander	18-23	 * 6	2-4	 * 4	16-19
Wok-brander	13-18	 * 7	1-3	 * 5	12-15
Snelbrander	15-20	 * 8	1-3	 * 6	14-17
Carbonara-saus					
Halfsnelbrander	10-15	 * 6	5-7	 * 3	5-8
Snelbrander	8-13	 * 5	4-6	 * 3	4-7
Hulpbrander	10-15	 * 9	5-7	 * 5	5-8
Vis					
Stokvis op Romeinse wijze					
Snelbrander	5-10	 * 8	5-10		
Halfsnelbrander	8-13	 * 9	8-13		
Wok-brander	4-9	 * 6	4-9		
Gebakken zalm					
Snelbrander	5-10	 * 7	2-4	 1	3-6
Halfsnelbrander	5-10	 * 8	2-4	 1	3-6
Wok-brander	7-12	 * 8	2-4	 1	5-8
Mosselen					
Snelbrander	5-7	 9	5-7		
Wok-brander	4-6	 9	4-6		
Halfsnelbrander	10-12	 9	10-12		

Gerecht Branders	Totaletijd in min.	Stap 1		Stap 2	
					
Vlees					
Eendenborst (1 stuk)					
Halfsnelbrander	6-8	 * 7	6-8		
Snelbrander	9-11	 * 7	9-11		
Wok-brander	6-8	 * 5	6-8		
Runderfilet Stroganoff					
Snelbrander	8-13	 * 9	8-13		
Wok-brander	5-10	 * 8	5-10		
Halfsnelbrander	12-17	 * 9	12-17		
Kipschnitzel (8 kipfilets)					
Snelbrander	7-12	 * 9	2-4	 * 6	5-8
Wok-brander	7-12	 * 9	2-4	 * 6	5-8
Halfsnelbrander	7-12	 * 9	7-12		
Gehakt (vleespastei, gehaktballen, bolognesesaus)					
Snelbrander	15-20	 * 8	15-20		
Halfsnelbrander	20-25	 * 9	20-25		
Wok-brander	15-20	 * 6	15-20		
Kant-en-klaar producten					
Diepvrieskroketten (16 stuks)					
Diepvrieskroketten (12 stuks)					
Snelbrander	6-10	 8	6-10		
Wok-brander	5-9	 8	5-9		
Halfsnelbrander	8-12	 8	8-12		
Braadworsten (12 stuks)					
Snelbrander	5-10	 9	1-3	 7	4-7
Halfsnelbrander	7-12	 9	7-12		
Wok-brander	5-10	 9	1-3	 7	4-7
Gekookte worst (12 stuks)					
Halfsnelbrander	8-13	 9	8-13		
Wok-brander	9-14	 4	9-14		
Snelbrander	7-12	 7	7-12		
Hamburgers (4 stuks)					
Snelbrander	4-9	 * 9	1-3	 * 7	3-6
Wok-brander	4-9	 * 9	1-3	 * 7	3-6
Halfsnelbrander	5-10	 * 9	1-3	 * 8	4-7
Diepvriesgroente**					
Snelbrander	7-12	 * 9	7-12		
Wok-brander	5-10	 * 9	5-10		
Halfsnelbrander	12-17	 * 9	12-17		
Pizza (20 cm diameter)					
Wok-brander	4-8	 1	4-8		
Snelbrander	16-20	 1	16-20		
Halfsnelbrander	20-25	 1	20-25		

Gerecht Branders	Totaletijd in min.	Stap 1		Stap 2	
					
Desserts					
Rijstpudding**					
Halfsnelbrander	30-35	 *	8 9-11	 *	4 21-24
Hulpbrander	40-45	 *	9 12-14	 *	2 28-31
Wok-brander	35-40	 *	7 11-13	 *	1 24-27
Melkchocolade					
Hulpbrander	10-14	 *	1 10-14		
Halfsnelbrander	16-20	 *	1 16-20		
Crêpes (4 stuks)					
Snelbrander	17-22	 *	7 1-3	 *	5 16-19
Wok-brander	8-13	 *	7 1-3	 *	4 7-10
Halfsnelbrander	20-25	 *	8 1-3	 *	6 19-22
Broodpudding					
Snelbrander	25-30	 *	9 10-12	 *	6 15-18
Wok-brander	23-28	 *	9 8-10	 *	7 15-18
Halfsnelbrander	27-32	 *	9 10-12	 *	7 17-20
Spaanse pudding**					
Snelbrander	3-8	 *	5 3-8		
Halfsnelbrander	8-13	 *	5 8-13		
Wok-brander	3-8	 *	2 3-8		
Cake (au bain-marie)					
Snelbrander	35-40	 *	9 35-40		
Wok-brander	40-45	 *	9 40-45		
Halfsnelbrander	45-50	 *	9 45-50		

Kooktips

- Gebruik een snelkookpan voor de bereiding van crèmesoepen en peulvruchten. De bereidingstijd wordt dan duidelijk korter. Gebruikt u een snelkookpan, houd u dan aan de aanwijzingen van de producent.
- Tijdens het koken van aardappels en rijst moet de pan altijd afgedekt zijn. De bereidingstijd wordt daardoor duidelijk korter.
- Bij pangerechten moet u eerst de olie warm maken. Zorg ervoor dat de temperatuur tijdens het bakken constant blijft door zo nodig de kookstand aan te passen. Wacht bij het klaarmaken van meerdere porties tot de bereidingstemperatuur weer bereikt is. U dient de gerechten regelmatig te keren.

Reinigen en onderhouden

Reiniging

Wanneer het apparaat koud is, reinig het met een spons, water en zeep.

Reinig na elk gebruik het oppervlak van de verschillende elementen van de brander, nadat deze is afgekoeld. Achtergebleven resten (aangekoekt voedsel, vetdruppels, enz.), hoe weinig ook, zetten zich vast op het oppervlak en zijn later moeilijker te verwijderen. Voor een correcte vlam moeten de openingen en gleuven schoon zijn.

De beweging van sommige pannen kan metaalresten achterlaten op de roosters.

Reinig de branders en de roosters met zeepsop en wrijf erover met een niet-metalen borstel.

Indien de roosters rubber voetjes hebben, wees voorzichtig bij het reinigen hiervan. De voetjes kunnen losraken en het rooster kan de kookplaat krassen.

Droog de branders en de roosters altijd volledig. De aanwezigheid van waterdruppels of vochtige zones bij de aanvang van het koken kan het email beschadigen.

Na het reinigen en drogen van de branders, zorg dat de branderdekseksels juist geplaatst zijn op de diffusor.

Attentie!

- Het is niet toegestaan de bedieningselementen te verwijderen om het apparaat schoon te maken. Het apparaat kan dan beschadigd raken door inkomend vocht.
- Gebruik geen stoomreinigers. Dit zou de kookplaat kunnen beschadigen.
- Gebruik nooit schuurmiddelen, staalsponzen, snijdende voorwerpen, messen, enz. om aangekoekte voedselresten van de kookplaat te verwijderen.
- Gebruik geen messen, schrapers of soortgelijk om de verbinding van het glas met de sierstrippen van de branders, metalen profielen te reinigen noch op de panelen van glas of aluminium indien aanwezig.

Onderhoud

Reinig meteen gemorste vloeistof. Zo wordt vermeden dat de etensresten zouden kleven en bespaart u onnodige inspanningen.

Schuif de pannen niet over het glas, aangezien er anders krassen kunnen ontstaan. Vermijd ook het vallen van harde of scherpe voorwerpen op het glas. Stoot niet tegen de randen van de kookplaat.

De zandkorrels (bijvoorbeeld afkomstig van de reiniging van bladgroenten en groenten) krassen het oppervlak van het glas.

Gesmolten suiker of voedsel met een hoog suikergehalte dat gemorst wordt, moet onmiddellijk verwijderd worden van de kookzone met behulp van de glasschraper.

Wat te doen bij storingen?

Soms kunnen storingen gemakkelijk worden verholpen. Neem de volgende aanwijzingen in acht voor u de servicedienst belt:

Afwijking	Mogelijke oorzaak	Oplossing
De algemene elektrische werking is defect.	Defecte zekering.	Controleer in de zekeringkast of de zekering stuk is en vervang deze.
	De automaat of een differentieel is gesprongen.	Controleer op het schakelbord of de automaat of een differentieel is gesprongen.
De automatische vonkontsteking werkt niet.	Er kunnen voedingsresten of resten van reinigingsmiddelen tussen de bougies en de branders zitten.	De ruimte tussen de bougie en de brander moet schoon zijn.
	De branders zijn nat.	Maak de branderdeksels zorgvuldig droog.
	De branderdeksels zijn niet juist geplaatst.	Controleer of de deksels juist geplaatst zijn.
	Het apparaat is niet geaard, niet goed aangesloten of de aardleiding is defect.	Neem contact op met de elektrische installateur.
De vlam van de brander is niet gelijkmatig.	De delen van de brander zijn niet juist geplaatst.	Plaats de onderdelen op de juiste wijze op de bijbehorende brander.
	De gleuven van de brander zijn vuil.	Reinig de gleuven van de brander.
De gasstroom lijkt niet normaal of er komt geen gas uit.	De gasuitlaat is gesloten met afsluitkranen.	Open de mogelijke afsluitkranen.
	Indien het gas uit een gasfles komt, kijk dan of deze leeg is.	Vervang de gasfles.
Het ruikt naar gas in de keuken.	Een kraan is open.	Sluit de kranen.
	De gasfles is niet goed aangesloten.	Controleer of de aansluiting perfect is.
	Mogelijk gaslek.	Draai de gaskraan dicht, ventileer de ruimte en waarschuw onmiddellijk een installatietechnicus, voor controle en certificatie van de installatie. Gebruik het apparaat niet totdat zeker is gesteld dat er geen gaslek is in de installatie of het apparaat.
De brander gaat meteen uit als de knop wordt losgelaten.	De knop is niet lang genoeg ingedrukt.	Houd de knop, nadat de brander ontvlamt, nog enkele seconden ingedrukt.
	De gleuven van de brander zijn vuil.	Reinig de gleuven van de brander.

Servicedienst

Indien onze Technische Dienst aangevraagd wordt, dient het productnummer (E-Nr.) en het fabricagenummer (FD) van het apparaat te worden verstrekt. Deze informatie staat op het gegevensplaatje, op de onderzijde van de kookplaat en op het label van de gebruiksaanwijzing.

De contactgegevens in alle landen vindt u in de bijgesloten lijst met Servicedienstadressen.

Verzoek om reparatie en advies bij storingen

NL 088 424 4020

B 070 222 142

Vertrouw op de competentie van de fabrikant. Dan bent u ervan verzekerd dat de reparatie wordt uitgevoerd door ervaren technici die gebruikmaken van de originele reserveonderdelen voor uw apparaat.

Garantievoorwaarden

Indien het apparaat, tegen onze verwachting in, schade vertoont of niet voldoet aan de voorziene kwaliteitseisen, verzoeken we u om ons dit zo snel mogelijk te laten weten. Opdat de garantie geldig zou zijn, mag het apparaat niet gemanipuleerd noch onderworpen zijn aan een ongeschikt gebruik.

De garantievoorwaarden die van toepassing zijn, worden bepaald door de vertegenwoordiging van onze onderneming in het land waarin de aankoop uitgevoerd is. U kunt gedetailleerde informatie aanvragen op onze verkooppunten. U moet het aankoopbewijs tonen om gebruik te maken van de garantie.

Recht op wijzigingen voorbehouden.

Milieubescherming

Staat het symbool  op het typeplaatje, neem dan de volgende aanwijzingen in acht.

Milieuvriendelijk afvoeren

Voer de verpakking op een milieuvriendelijke manier af.



Dit apparaat is gekenmerkt in overeenstemming met de Europese richtlijn 2012/19/EU betreffende afgedankte elektrische en elektronische apparatuur (waste electrical and electronic equipment - WEEE). De richtlijn geeft het kader aan voor de in de EU geldige terugname en verwerking van oude apparaten.

De verpakking van uw apparaat is vervaardigd uit materialen die strikt noodzakelijk zijn om een goede bescherming te garanderen tijdens het vervoer. Deze materialen zijn volledig recyclebaar, op deze wijze wordt het milieueffect verminderd. We nodigen u uit om ook bij te dragen tot het behoud van het milieu, door onderstaande raadgevingen op te volgen:

- gooi de verpakking in de daarvoor bestemde container voor recycling,
- maak een afgedankt apparaat onbruikbaar alvorens het weg te doen. Raadpleeg bij uw lokale overheid het adres van het dichtstbijzijnde inzamelpaats voor recyclebaar materiaal en lever daar uw apparaat in,
- spoel gebruikte olie niet door de gootsteen. Bewaar deze in een gesloten vat en geef deze af in een inzamelpunt of bij het ontbreken hiervan, in een vuilnisbak, (deze komt terecht op een gecontroleerde stortplaats; waarschijnlijk is dit niet de beste oplossing, maar we vermijden waterverontreiniging).

BSH Hausgeräte GmbH
Carl-Wery-Str. 34
81739 München, GERMANY

siemens-home.com

Hergestellt von BSH Hausgeräte GmbH unter Markenlizenz der Siemens AG
Fabriqué par BSH Hausgeräte GmbH titulaire des droits d'utilisation de la marque Siemens AG
Prodotto da BSH Hausgeräte GmbH in quanto licenziatario del marchio di Siemens AG
Gefabriceerd door BSH Hausgeräte GmbH onder handelsmerklizentie van Siemens AG



9001230551
960714(A)