

SIEMENS



Built-in oven

CM656GB.1

siemens-home.com/welcome

en Instruction manual

Register
your
product
online

Table of contents

 Intended use	4	 Microwave	17
 Important safety information	5	Cookware	17
General information	5	Microwave power settings	18
Microwave	5	Setting the microwave combined with a type of heating	18
 Causes of damage	7	Setting the microwave	18
General information	7	Dry	19
Microwave	8	 Sabbath mode	19
 Environmental protection	8	Starting Sabbath mode	19
Saving energy	8	 Cleaning function	19
Environmentally-friendly disposal	8	Prior to initiating the cleaning function	19
 Getting to know your appliance	9	Setting the cleaning function	19
Control panel	9	Once the cleaning function has ended	20
Controls	9	 Cleaning agent	20
Display	9	Suitable cleaning agents	20
Operating modes menu	10	Surfaces in the cooking compartment	21
Types of heating	10	Keeping the appliance clean	21
Further information	11	 Rails	22
Cooking compartment functions	11	Detaching and refitting the rails	22
 Accessories	11	 Appliance door	23
Accessories included	11	Removing the door cover	23
Inserting accessories	12	Removing and fitting the door panels	24
Optional accessories	12	 Trouble shooting	25
 Before using for the first time	13	Fault table	25
Initial use	13	Maximum operating time exceeded	25
Cleaning the cooking compartment and accessories	13	Cooking compartment bulbs	25
 Operating the appliance	13	 Customer service	26
Switching the appliance on and off	13	E number and FD number	26
Starting or interrupting operation	14	 Dishes	26
Selecting an operating mode	14	Information on the settings	26
Setting the type of heating and temperature	14	Selecting a dish	27
Rapid heat up	14	Applying settings for dishes	27
 Time-setting options	15	 Tested for you in our cooking studio	28
Timer	15	Silicone moulds	28
Cooking time	15	Cakes and small baked items	28
End time	16	Bread and rolls	31
 Childproof lock	16	Pizza, quiche and savoury cakes	33
Activating and deactivating	16	Bakes and soufflés	34
 Basic settings	16	Poultry	36
Changing settings	16	Meat	38
List of settings	16	Fish	41
Changing the time	17	Vegetables and side dishes	42

Dessert.	44
Eco types of heating	45
Acrylamide in foodstuffs.	47
Slow cook	47
Drying.	48
Preserving	49
Prove dough.	50
Defrosting.	50
Heating food in a microwave	52
Keeping warm	53
Test dishes.	53

Additional information on products, accessories, replacement parts and services can be found at www.siemens-home.com and in the online shop www.siemens-eshop.com

Intended use

Read these instructions carefully. Only then will you be able to operate your appliance safely and correctly. Retain the instruction manual and installation instructions for future use or for subsequent owners.

This appliance is only intended to be fully fitted in a kitchen. Observe the special installation instructions.

Check the appliance for damage after unpacking it. Do not connect the appliance if it has been damaged in transport.

Only a licensed professional may connect appliances without plugs. Damage caused by incorrect connection is not covered under warranty.

This appliance is intended for domestic use only. The appliance must only be used for the preparation of food and drink. The appliance must be supervised during operation. Only use this appliance indoors.

This appliance is intended for use up to a maximum height of 4000 metres above sea level.

This appliance may be used by children over the age of 8 years old and by persons with reduced physical, sensory or mental capabilities or by persons with a lack of experience or knowledge if they are supervised or are instructed by a person responsible for their safety how to use the appliance safely and have understood the associated hazards.

Children must not play with, on, or around the appliance. Children must not clean the appliance or carry out general maintenance unless they are at least 8 years old and are being supervised.

Keep children below the age of 8 years old at a safe distance from the appliance and power cable.

Always slide accessories into the cooking compartment the right way round.

→ "Accessories" on page 11

Important safety information

General information

Warning – Risk of fire!

- Combustible items stored in the cooking compartment may catch fire. Never store combustible items in the cooking compartment. Never open the appliance door if there is smoke inside. Switch off the appliance and unplug it from the mains or switch off the circuit breaker in the fuse box.
- A draught is created when the appliance door is opened. Greaseproof paper may come into contact with the heating element and catch fire. Do not place greaseproof paper loosely over accessories during preheating. Always weight down the greaseproof paper with a dish or a baking tin. Only cover the surface required with greaseproof paper. Greaseproof paper must not protrude over the accessories.

Warning – Risk of burns!

- The appliance becomes very hot. Never touch the interior surfaces of the cooking compartment or the heating elements. Always allow the appliance to cool down. Keep children at a safe distance.
- Accessories and ovenware become very hot. Always use oven gloves to remove accessories or ovenware from the cooking compartment.
- Alcoholic vapours may catch fire in the hot cooking compartment. Never prepare food containing large quantities of drinks with a high alcohol content. Only use small quantities of drinks with a high alcohol content. Open the appliance door with care.

Warning – Risk of scalding!

- The accessible parts become hot during operation. Never touch the hot parts. Keep children at a safe distance.
- When you open the appliance door, hot steam can escape. Steam may not be visible, depending on its temperature. When opening, do not stand too close to the appliance. Open the appliance door carefully. Keep children away.
- Water in a hot cooking compartment may create hot steam. Never pour water into the hot cooking compartment.

Warning – Risk of injury!

- Scratched glass in the appliance door may develop into a crack. Do not use a glass scraper, sharp or abrasive cleaning aids or detergents.
- The hinges on the appliance door move when opening and closing the door, and you may be trapped. Keep your hands away from the hinges.

Warning – Risk of electric shock!

- Incorrect repairs are dangerous. Repairs may only be carried out and damaged power cables replaced by one of our trained after-sales technicians. If the appliance is defective, unplug the appliance from the mains or switch off the circuit breaker in the fuse box. Contact the after-sales service.
- The cable insulation on electrical appliances may melt when touching hot parts of the appliance. Never bring electrical appliance cables into contact with hot parts of the appliance.
- Do not use any high-pressure cleaners or steam cleaners, which can result in an electric shock.
- A defective appliance may cause electric shock. Never switch on a defective appliance. Unplug the appliance from the mains or switch off the circuit breaker in the fuse box. Contact the after-sales service.

Warning – Hazard due to magnetism!

Permanent magnets are used in the control panel or in the control elements. They may affect electronic implants, e.g. heart pacemakers or insulin pumps. Wearers of electronic implants must stay at least 10 cm away from the control panel.

Microwave

Warning – Risk of fire!

- Using the appliance for anything other than its intended purpose is dangerous and may cause damage. The following is not permitted: drying out food or clothing, heating slippers, grain or cereal pillows, sponges, damp cleaning cloths or similar. For example, heated slippers and grain or cereal pillows may catch fire, even several hours after they have been heated. The appliance must only be used for the preparation of food and drinks.

- Food may catch fire. Never heat food in heat-retaining packages. Do not leave food heating unattended in containers made of plastic, paper or other combustible materials. Do not select a microwave power or time setting that is higher than necessary. Follow the information provided in this instruction manual. Never use the microwave to dry food. Never defrost or heat food with a low water content, e.g. bread, at too high a microwave power or for too long.
- Cooking oil may catch fire. Never use the microwave to heat cooking oil on its own.

⚠ Warning – Risk of explosion!

Liquids and other food may explode when in containers that have been tightly sealed. Never heat liquids or other food in containers that have been tightly sealed.

⚠ Warning – Risk of burns!

- Foods with peel or skin may burst or explode during, or even after, heating. Never cook eggs in their shells or reheat hard-boiled eggs. Never cook shellfish or crustaceans. Always prick the yolk when baking or poaching eggs. The skin of foods that have a peel or skin, such as apples, tomatoes, potatoes and sausages, may burst. Before heating, prick the peel or skin.
- Heat is not distributed evenly through baby food. Never heat baby food in closed containers. Always remove the lid or teat. Stir or shake well after the food has been heated. Check the temperature of the food before it is given to the child.
- Heated food gives off heat. The ovenware may become hot. Always use oven gloves to remove ovenware or accessories from the cooking compartment.
- Airtight packaging may burst when food is heated. Always observe the instructions on the packaging. Always use oven gloves to remove dishes from the cooking compartment.

⚠ Warning – Risk of scalding!

- There is a possibility of delayed boiling when a liquid is heated. This means that the liquid reaches boiling temperature without the usual steam bubbles rising to the surface. Even if the container only vibrates a little, the hot liquid may suddenly boil over and spatter. When heating, always place a spoon in the container. This will prevent delayed boiling.

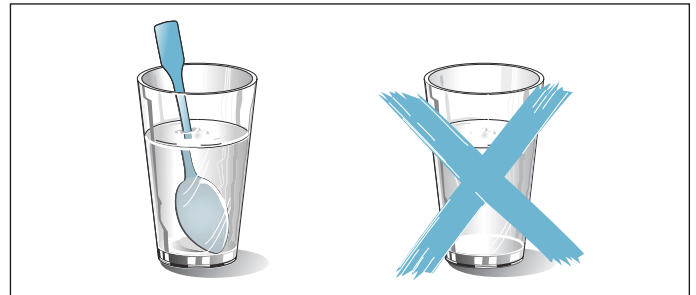

⚠ Warning – Risk of injury!

- Unsuitable ovenware may crack. Porcelain or ceramic ovenware can have small perforations in the handles or lids. These perforations conceal a cavity below. Any moisture that penetrates this cavity could cause the ovenware to crack. Only use microwave-safe ovenware.
- If using the appliance in microwave mode only, placing cookware and containers made of metal inside the appliance may cause sparks when the appliance is operating. This will damage the appliance. Never use metal containers when using the appliance in microwave mode only. Use only microwave-safe cookware or, alternatively, the microwave in combination with a type of heating.

⚠ Warning – Risk of electric shock!

The appliance is a high-voltage appliance. Never remove the casing.

⚠ Warning – Risk of serious damage to health!

- The surface of the appliance may become damaged if it is not cleaned properly. Microwave energy may escape. Clean the appliance on a regular basis, and remove any food residue immediately. Always keep the cooking compartment, door seal, door and door stop clean.

- Microwave energy may escape if the cooking compartment door or the door seal is damaged. Never use the appliance if the cooking compartment door, the door seal or the plastic door frame is damaged. Call the after-sales service.
- Microwave energy will escape from appliances that do not have any casing. Never remove the casing. For any maintenance or repair work, contact the after-sales service.

Causes of damage

General information

Caution!

- Accessories, foil, greaseproof paper or ovenware on the cooking compartment floor: do not place accessories on the cooking compartment floor. Do not cover the cooking compartment floor with any sort of foil or greaseproof paper. Do not place ovenware on the cooking compartment floor if a temperature of over 50 °C has been set. This will cause heat to accumulate. The baking and roasting times will no longer be correct and the enamel will be damaged.
- Aluminium foil: Aluminium foil in the cooking compartment must not come into contact with the door glass. This could cause permanent discolouration of the door glass.
- Water in a hot cooking compartment: do not pour water into the cooking compartment when it is hot. This will cause steam. The temperature change can cause damage to the enamel.
- Moisture in the cooking compartment: Over an extended period of time, moisture in the cooking compartment may lead to corrosion. Allow the cooking compartment to dry after use. Do not keep moist food in the closed cooking compartment for extended periods of time. Do not store food in the cooking compartment.
- Cooling with the appliance door open: Following operation at high temperatures, only allow the cooking compartment to cool down with the door closed. Do not trap anything in the appliance door. Even if the door is only left open a crack, the front of nearby furniture may become damaged over time. Only leave the cooking compartment to dry with the door open if a lot of moisture was produced whilst the oven was operating.
- Fruit juice: when baking particularly juicy fruit pies, do not pack the baking tray too generously. Fruit juice dripping from the baking tray leaves stains that cannot be removed. If possible, use the deeper universal pan.
- Extremely dirty seal: If the seal is very dirty, the appliance door will no longer close properly during operation. The fronts of adjacent units could be damaged. Always keep the seal clean.
- Appliance door as a seat, shelf or worktop: Do not sit on the appliance door, or place or hang anything on it. Do not place any cookware or accessories on the appliance door.
- Inserting accessories: depending on the appliance model, accessories can scratch the door panel when closing the appliance door. Always insert the accessories into the cooking compartment as far as they will go.
- Carrying the appliance: do not carry or hold the appliance by the door handle. The door handle cannot support the weight of the appliance and could break.

Microwave

Caution!

- Creation of sparks: Metal – e.g. a spoon in a glass – must be kept at least 2 cm from the cooking compartment walls and the inside of the door. Sparks can irreparably damage the glass on the inside of the door.
- Combining accessories: Do not combine the wire rack with the universal pan. Sparks may be created if they are inserted directly on top of one another. Only insert them into their own shelf level.
- Microwave only: The universal pan and baking tray are unsuitable when using the microwave only. If you use either of these, this may create sparks, which may damage the cooking compartment. Place cookware on the wire rack provided, or place it in the microwave and set a type of heating.
- Foil containers: Do not use foil containers in the appliance. They damage the appliance by producing sparks.
- Operating the microwave without food: Operating the appliance without food in the cooking compartment may lead to overloading. Never switch on the microwave unless there is food inside. The short crockery test is the exception to this rule.
→ "Microwave" on page 17

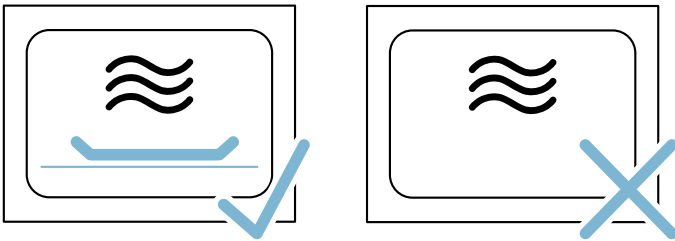

- Microwave popcorn: Never set the microwave output too high. Use a maximum microwave output of 600 watts. Always place the popcorn bag on a glass plate. The door panels may jump if overloaded.

Environmental protection

Your new appliance is particularly energy-efficient. Here you can find tips on how to save even more energy when using the appliance, and how to dispose of your appliance properly.

Saving energy

- Only preheat the appliance if this is specified in the recipe or in the tables in the operating instructions.
- Use dark, black lacquered or enamelled baking tins. They absorb heat particularly well.
- Open the appliance door as infrequently as possible during operation.
- It is best to bake several cakes one after the other. The cooking compartment is still warm. This reduces the baking time for the second cake. You can place two cake tins next to each other in the cooking compartment.
- For longer cooking times, you can switch the appliance off 10 minutes before the end of the cooking time and use the residual heat to finish cooking.

Environmentally-friendly disposal

Dispose of packaging in an environmentally-friendly manner.



This appliance is labelled in accordance with European Directive 2012/19/EU concerning used electrical and electronic appliances (waste electrical and electronic equipment - WEEE). The guideline determines the framework for the return and recycling of used appliances as applicable throughout the EU.

Getting to know your appliance

In this chapter, we will explain the displays and controls. You will also find out about the various functions of your appliance.

Note: Depending on the appliance model, individual details and colours may differ.

Control panel

In the control panel, you can use the various buttons and the rotary selector to set the required function of the appliance. The current settings are shown on the display.



1 Buttons

The buttons to the left and right of the rotary selector have a pressure point. Press these buttons to activate them.

2 Rotary selector

You can turn the rotary selector clockwise and anti-clockwise.

3 Touch display

You can see the current adjustment values, options or notes in the touch display. To implement settings, touch the appropriate text field. The text fields change depending on the selection.

Start/Stop

Starts, pauses or cancels operation

Rotary selector

Use the rotary selector to change the adjustment values shown in the display.

In most selection lists, e.g. types of heating, the first selection follows the last. For temperature, for example, you must turn the rotary selector back when the minimum or maximum temperature is reached.

Display

The display is structured so that the information can be read at a glance.

The value that you can currently set is in focus. It is displayed in white lettering with a dark background.

Status bar

The status bar is at the top of the display. The time and set time functions are displayed here.

Progress line





The progress line shows you how much the oven has already heated up or how much time has elapsed, for example. The straight line below the in-focus value progresses from left to right, the longer the operation continues to run.

Controls

The individual controls are adapted for the various functions of your appliance. You can set your appliance simply and directly.

Buttons

Here you can find a short explanation of the various buttons.

Buttons	Meaning	
on/off		Switches the appliance on and off
menu	Menu	Opens the operating modes menu
 	Information	Displays notes
	Childproof lock	Activates/deactivates the child-proof lock
	Time-setting options	Opens the time-setting options menu
	Rapid heat up	Switches rapid heat up on and off

Countdown

If you have started your appliance without a cooking time, you can see how long the operation has already been running for at the top right in the status bar.

If you had set a cooking time and it was deleted, the countdown applies the time that has already elapsed and continues to count down from this time. You can therefore always check how long the operation has already been running.

Temperature indicator

The temperature indicator bars show the heating phases or residual heat in the cooking compartment.

Heating indicator	The heating indicator displays the rising temperature in the cooking compartment. When all bars are filled, the optimum time for placing the dish in the oven has been reached. The bars do not appear when settings are applied for grilling and cleaning.
Residual heat indicator	When the appliance is switched off, the temperature indicator shows the residual heat in the cooking compartment. Once the temperature has dropped to approximately 60 °C, the display goes out.

Note: Due to thermal inertia, the temperature displayed may be slightly different to the actual temperature inside

the oven. You can use the  button to check the current heating temperature when heating up.









Operating modes menu





The menu is divided into different operating modes. In this way, you can quickly access the required function.

Operating mode	Use
Types of heating	There are several finely tuned types of heating for you to prepare your dishes.
Dishes → "Dishes" on page 26	Here you can find preprogrammed setting values which are suitable for many dishes.
Microwave → "Microwave" on page 17	Using the microwave you can cook, heat up or defrost your dishes more quickly.
Microwave combination → "Microwave" on page 17	Using microwave combination, you can activate a type of heating in addition to the microwave.
Dry → "Microwave" on page 17	Use after every operation with steam or the microwave.
Cleaning function → "Cleaning function" on page 19	The cleaning function cleans your oven almost automatically.
Settings → "Basic settings" on page 16	You can adapt your appliance's basic settings to suit your needs.

Types of heating

In order for you to find the correct type of heating for your dish, we have explained the differences and scopes of application here.

Types of heating	Temperature	Use
 4D hot air	30-275 °C	For baking and roasting on one or more levels. The fan distributes the heat from the ring heating element in the back panel evenly around the cooking compartment.
 Top/bottom heating	30-300 °C	For traditional baking and roasting on one level. Especially suitable for cakes with moist toppings. Heat is emitted evenly from above and below.
 Hot air eco	30-275 °C	For gentle cooking of selected dishes on one level without preheating. The fan distributes the heat from the ring heating element in the back panel around the cooking compartment.
 Top/bottom heating eco	30-300 °C	For gentle cooking of selected dishes on one level. The heat is emitted from above and below.
 Hot air grilling	30-300 °C	For roasting poultry, whole fish and larger pieces of meat. The grill heating element and the fan switch on and off alternately. The fan circulates the hot air around the food.
 Grill, large area	Grill settings: 1 = low 2 = medium 3 = high	For grilling flat items such as steaks, sausages or bread, and for browning food. The whole area of the grill heating element becomes hot.
 Grill, small area	Grill settings: 1 = low 2 = medium 3 = high	For grilling small quantities of food such as steaks, sausages or bread, and for browning food. The centre part under the grill heating element becomes hot.
 Pizza setting	30-275 °C	For preparing pizza and dishes which require a lot of heat from underneath. The bottom heating element and the ring heating element in the back panel heat up.

	Slow cooking	70-120 °C	For gentle and slow cooking of seared, tender pieces of meat in ovenware without a lid. The heat is emitted evenly from the top and bottom at low temperatures.
	Bottom heating	30-250 °C	For cooking in a bain marie and for the final baking stage. The heat is emitted from below.
	Keeping warm	60-100 °C	For keeping cooked food warm.
	Preheating ovenware	30-70 °C	For preheating ovenware.
	CoolStart function	30-275 °C	For the quick preparation of frozen products on level 1. The temperature depends on the manufacturer's instructions. Use the highest temperature specified on the packaging. The cooking time is as specified or shorter. Preheating is not required.

Default values

For each type of heating, the appliance specifies a default temperature or level. You can accept this value or change it in the appropriate area.

Further information

In most cases, the appliance provides notes and further information on the action just carried out. To do this, press the  button. The note is shown for a few seconds.

Some notes are displayed automatically, for example as confirmation, or to provide an instruction or warning.

Cooking compartment functions

Some functions make your appliance easier to use. This, for example, enables the cooking compartment to be well lit and a cooling fan to prevent the appliance from overheating.

Opening the appliance door

If you open the appliance door during an operation, the operation is paused. The operation resumes when you close the door.

Interior lighting

When you open the appliance door, the interior lighting switches on. If the door remains open for longer than 15 minutes, the lighting switches off again.

For most operating modes, the interior lighting switches on as soon as the operation is started. When the operation has finished, the lighting switches off.

Note: You can set the interior lighting not to come on during the operation in the basic settings.

Cooling fan

The cooling fan switches on and off as required. The hot air escapes above the door.

Caution!

Do not cover the ventilation slots. Otherwise the oven will overheat.

So that the cooking compartment cools down more quickly after operation, the cooling fan continues to run for a certain period afterwards.

Note: You can change how long the cooling fan continues to run for in the basic settings. → "Basic settings" on page 16

Accessories

Your appliance is accompanied by a range of accessories. Here, you can find an overview of the accessories included and information on how to use them correctly.

Accessories included

Your appliance is equipped with the following accessories:

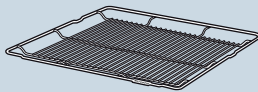
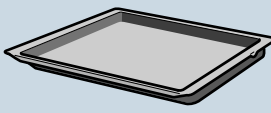
	Wire rack For ovenware, cake tins and ovenproof dishes. For roasts, grilled items and frozen meals. The wire rack is suitable for use in the microwave.
	Universal pan For moist cakes, pastries, frozen meals and large roasts. It can be used to catch dripping fat when you are grilling directly on the wire rack.

Only use original accessories. They are specially adapted for your appliance.

You can buy accessories from the after-sales service, from specialist retailers or online.

Note: The accessories may deform when they become hot. This does not affect their function. Once they have cooled down again, they regain their original shape.

Microwave

Only the wire rack provided is suitable when using the microwave only. If you use the universal pan or the baking tray, this may create sparks, which may damage the cooking compartment.

When using the appliance in combination with the microwave or "Dishes" mode, you can use the universal pan, baking tray or any other accessories that have been included with the appliance.

Inserting accessories

The cooking compartment has three shelf positions. The shelf positions are counted from the bottom up.

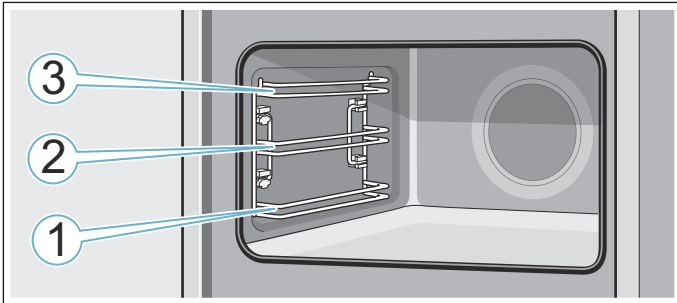

When using positions 1, 2 and 3, always insert the accessory between the two guide rods for a shelf position.

Notes

- Ensure that you always insert the accessories into the cooking compartment the right way round.
- Always insert the accessories fully into the cooking compartment so that they do not touch the appliance door.

Locking function

The accessories can be pulled out approximately halfway until they lock in place. The locking function prevents the accessories from tilting when they are pulled out. The accessories must be inserted into the cooking compartment correctly for the tilt protection to work properly.

When inserting the wire rack, ensure that the catch tappet **a** is at the rear and is facing downwards. The lettering "microwave" must be at the front and the outer rail must face downwards .

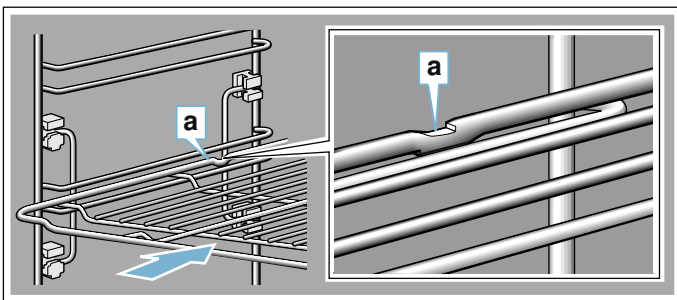

When inserting baking trays, ensure that the catch tappet **a** is at the rear and is facing downwards. The sloping edge of the accessory **b** must be facing forwards towards the appliance door.

Example in the picture: Universal pan

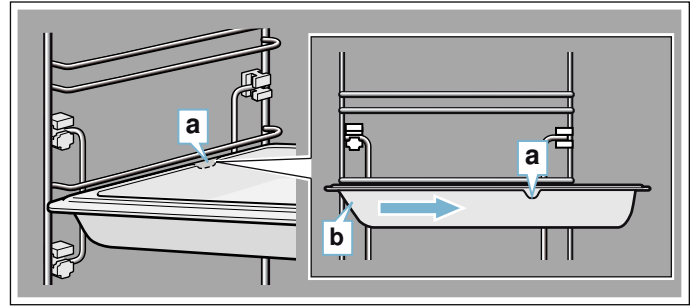

Optional accessories

You can buy optional accessories from the after-sales service, from specialist retailers or online. *You will find a comprehensive range of products for your appliance in our brochures and online.

Both availability and whether it is possible to order online differ between countries. Please see your sales brochures for more details.

Note: Not all optional accessories are suitable for every appliance. When purchasing, please always quote the exact identification number (E-no.) of your appliance. → "Customer service" on page 26

Special accessories

Wire rack

For ovenware, cake tins and ovenproof dishes, and for roasts and grilled food.

Universal pan

For moist cakes, pastries, frozen meals and large roasts. It can be used to catch dripping fat when you are grilling directly on the wire rack.

Baking tray

For tray bakes and small baked products.

Wire insert

For meat, poultry and fish. For inserting into the universal pan to catch dripping fat and meat juices.

Universal pan, non-stick

For moist cakes, pastries, frozen meals and large roasts. Pastries and roasts can be removed more easily from the universal pan.

Baking tray, non-stick

For tray bakes and small baked products. The pastries can be removed more easily from the baking tray.

Profi pan

For preparing large quantities.

Lid for the Profi pan

The lid turns the Profi pan into a Profi roasting dish.

Pizza tray

For pizzas and large round cakes.

Grill tray

Use for grilling in place of the wire rack or as a splatter guard. Only use in the universal pan.

Bread-baking stone

For home-made bread, bread rolls and pizzas that require a crispy base.

The baking stone must be preheated to the recommended temperature.

Glass roasting dish (5.1 litres)

For stews and bakes.

Particularly suitable for the "Meals" operating mode.

Glass tray

For large roasts, moist cakes and bakes.

Glass tray

For bakes, vegetable dishes and baked goods.

Decorative trims

For concealing the lower shelf of the unit and the base of the appliance.

Before using for the first time

Before you can use your new appliance, you must make some settings. You must also clean the cooking compartment and accessories.

Initial use

After connecting the appliance to the power or following a power cut, the settings for initial use are shown in the display.

Note: You can change these settings at any time in the basic settings. → "Basic settings" on page 16

Setting the language

German is the preset language.

1. Use the rotary selector to select the required language.
2. Touch the > arrow.
The next setting appears.

Setting the time

The time starts at 12:00.

1. Use the rotary selector to set the current time.
2. Touch the > arrow

Setting the date

The default date is "1.1.2014".

1. Use the rotary selector to set the current day, month and year.
2. Touch the > arrow until you have updated all settings.
A note appears in the display confirming that the initial use has been completed.

Cleaning the cooking compartment and accessories

Before using the appliance to prepare food for the first time, you must clean the cooking compartment and accessories.

Cleaning the cooking compartment

To remove the new-appliance smell, heat up the cooking compartment when empty and with the oven door closed.

Make sure that the cooking compartment does not contain any leftover packaging, such as polystyrene pellets. Before heating the appliance, wipe the smooth surfaces in the cooking compartment with a soft, wet cloth. Keep the kitchen ventilated while the appliance is heating.

Apply the settings indicated.

Settings

Type of heating	Top/bottom heating 
Temperature	240 °C
Cooking time	1 hour

You can find out how to set the type of heating and the temperature in the next section.

Switch off the appliance after the cooking time indicated using the On/Off button.

After the cooking compartment has cooled down, clean the smooth surfaces with soapy water and a dish cloth.

Cleaning the accessories

Clean the accessories thoroughly using soapy water and a dish cloth or soft brush.

Operating the appliance

You have already learnt about the controls and how they work. Now we will explain how to set your appliance. You will learn about what happens when you switch the appliance on and off, and how to select the operating mode.

Switching the appliance on and off

Before you are able to set the appliance, you must switch it on.

Exception: The childproof lock and the timer can be set when the appliance is switched off.

Displays or information, e.g the residual heat indicator in the cooking compartment, remain visible in the display after the appliance has been switched off.

Switch off your appliance when you do not need to use it. If no settings are applied for a long time, the appliance switches itself off automatically.

Switching the appliance on

Use the On/Off button to switch the appliance on. The on/off symbol above the button is illuminated in blue.

The Siemens logo appears in the display, and then a type of heating and a temperature.

Note: You can specify which operating modes should appear after the appliance is switched on in the basic settings.

Switching off the appliance

Use the On/Off button to switch off the appliance. The lighting above the button goes out.

A set function is cancelled.

The time appears in the display.

Note: You can set whether or not the time should be displayed when the appliance is switched off in the basic settings.

Starting or interrupting operation

To start operation or to interrupt an operation which has started running, press the Start/Stop button. The cooling fan may continue to run after an operation is interrupted.

Press the On/Off button to delete all settings.

If you open the cooking compartment door during operation, operation is interrupted. Close the cooking compartment door to continue operation.

Selecting an operating mode

When you select an operating mode, the appliance must be switched on.

1. Press the menu button.
The operating modes menu opens.
2. Touch the required operating mode.
Depending on the operating mode, different options are available.
3. Use the rotary selector to change the selection.
Depending on the selection, change further settings.
4. Use the start/stop button to start.
The elapsed time appears in the display. The settings and progress line can be seen.

Setting the type of heating and temperature

After the appliance is switched on, the set suggested type of heating appears with the temperature. You can start this setting immediately with the start/stop button. If you want to set another type of heating, proceed as follows.

For other settings, you can change the values as follows:

Example in the picture: Top/bottom heating at 180 °C.

1. Set the type of heating using the rotary selector.

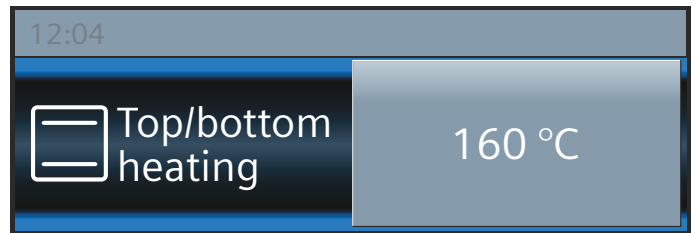

2. Touch the suggested temperature.
3. Use the rotary selector to change the temperature.

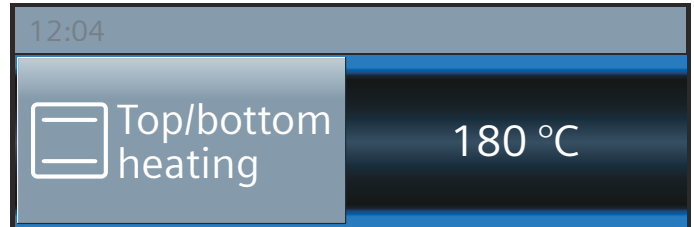

4. Use the start/stop button to start.

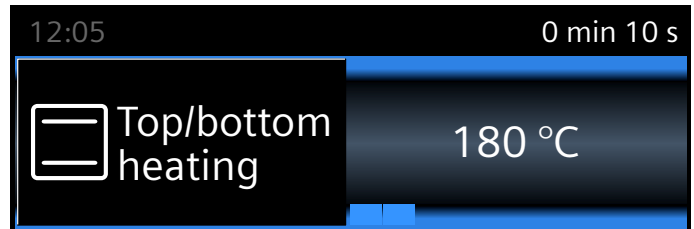

The set type of heating and the temperature are shown in the display.

Rapid heat up

You can use the »||| button to heat up the cooking compartment particularly quickly. The rapid heat up function is not possible for all types of heating.

Suitable types of heating:

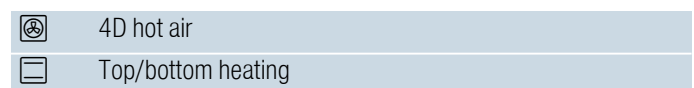

To ensure an even cooking result, do not place your food and the accessory in the cooking compartment until rapid heating is complete.

Making settings

Ensure you have selected a suitable type of heating. The temperature must be set to above 100 °C, otherwise the rapid heating function cannot be started.

1. Set the type of heating and temperature.
2. Press the »||| button.

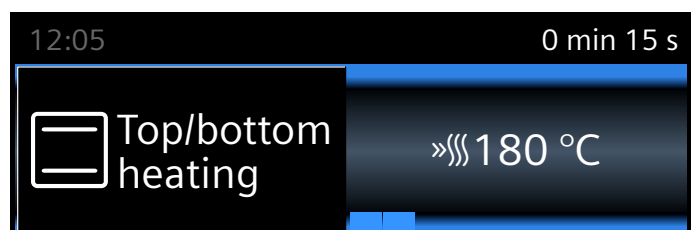

The »»» symbol appears on the left next to the temperature. The temperature indicator starts to fill in.

When rapid heating is complete, a signal sounds. The »»» symbol goes out. Place your dish in the cooking compartment.

Notes



- If a cooking time has been set, this runs independently of rapid heating and counts down immediately when the operation is started.
- You can use the  button to check the current cooking compartment temperature during rapid heating.

Cancelling

Press the »»» button. The »»» symbol disappears from the display.

Time-setting options

Your appliance has different time-setting options.

Time-setting option	Use
 Timer	The timer functions like an egg timer. An audible signal sounds once the set time has elapsed.
 Cooking time	A signal sounds once a set cooking time has elapsed. The appliance switches off automatically.
 End time	Set a cooking time and an end time. The appliance switches off automatically so that the operation ends at the desired time.

Notes

- A cooking time of up to one hour can be set exactly to the minute.
A cooking time over one hour can be set in five-minute increments.
- Depending on which direction you turn the rotary selector, the cooking time starts at a default value:
Anti-clockwise, 10 minutes,
Clockwise, 30 minutes.
- After a time-setting option has elapsed, a signal sounds and "Finished" appears in the status bar.
- Using the  button, you can request information during the operation, which then appears briefly in the display.

Timer

You can set the timer at any time, even if the appliance is switched off. It runs parallel to the other time settings and has a separate audible signal. In this way, you can tell whether it is the timer or a cooking time which has elapsed.

The maximum setting you can apply is 24 hours.

1. Press the  button.
The field for the timer opens.



2. Use the rotary selector to set the timer duration.
The timer starts after a few seconds.

The  symbol for the timer and the time counting down are displayed on the left in the status bar.



When the time has elapsed

An audible signal sounds. "Timer elapsed" appears in the display. Use the  button to cancel the audible signal early.

Cancelling the timer duration

Press the  button to open the time-setting options menu and turn the time back. Press the  button to close the menu.

Changing the timer duration

Use the  button to open the time-setting options menu and change the timer time in the next few seconds using the rotary selector. Start the timer with the  button.

Cooking time

If you set the cooking time for your meal, the operation stops automatically once this time has elapsed. The oven stops heating.

Prerequisite: A type of heating and a temperature have been set.

For example: Setting for 4D hot air, 180 °C, cooking time 45 minutes.

1. Press the  button.
The time-setting options menu opens.

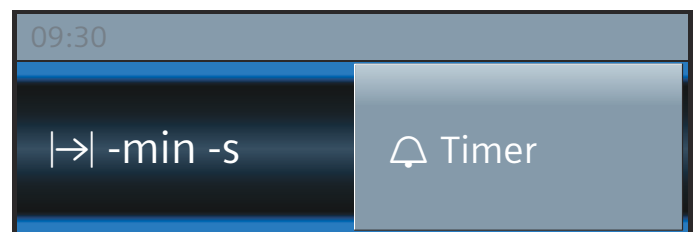

2. Set the cooking time using the rotary selector.

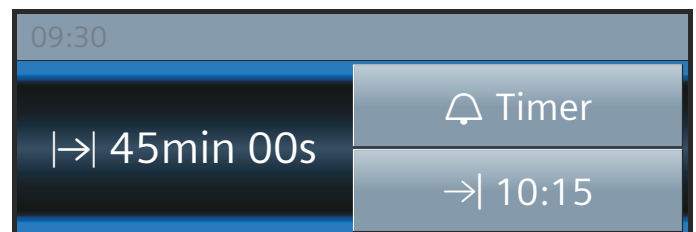

3. Press the Start/Stop button to start.
You can see the  cooking time counting down in the status bar.

The cooking time has elapsed

A signal sounds. The oven stops heating. "Finished" appears in the status bar. You can cancel the audible signal early using the  button.

Cancelling the cooking time

Press the  button to open the time-setting options menu. Turn the time back. The type of heating and temperature set are shown in the display.

Changing the cooking time

Press the  button to open the time-setting options menu. Change the cooking time using the rotary selector.

End time

If you change the end time, please remember that easily spoiled foods must not be allowed to remain in the cooking compartment for too long.

Prerequisite: The selected operation has not already begun. A cooking time has been set. The time-setting options menu  is open.

Example in the picture: You put the dish in the cooking compartment at 9:30. It takes 45 minutes to cook and will be ready at 10:15, but you would like it to be ready at 12:45 instead.

1. Touch the "End →|" field.
The end time is displayed.

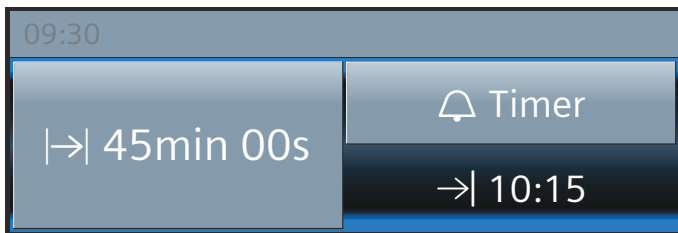

2. Using the rotary selector, set a later end time.

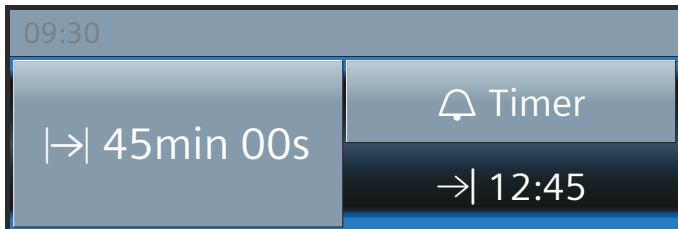

3. Confirm with the Start/Stop button.





The oven is in standby. The operation starts at the appropriate time. You can see the cooking time counting down in the status bar.

The cooking time has elapsed

A signal sounds. The oven stops heating. "Finished" appears in the status bar. You can cancel the audible signal early using the  button.

Correcting the end time

This is possible if the oven is in standby. Use the  button to open the time-setting options menu, touch "End →|" and use the rotary selector to correct the end time. Press the  button to close the menu.

Cancelling the end time

This is possible if the oven is on standby. To do so, open the time-setting options menu using the  button. Touch "End →|" and reset the End time using the rotary selector. The cooking time immediately starts to count down.



Childproof lock

Your appliance is equipped with a childproof lock so that children cannot switch it on accidentally or change any settings.

The control panel is locked and no settings can be made. The appliance can only be switched off using the on/off button.

Activating and deactivating

You can activate and deactivate the childproof lock when the appliance is switched on or off.

In each case, press the  button for approx. 4 seconds. A confirmation note appears in the display and the  symbol appears in the status bar.

Basic settings

There are various settings available to you in order to help use your appliance effectively and simply. You can change these settings as required.

Changing settings

1. Press the On/Off button.
2. Press the menu button.
The operating modes menu opens.
3. Select the "Settings" operating mode.
The first basic setting appears and can be changed using the rotary selector.
4. Touch the > arrow.
5. Use the rotary selector to change the values.
6. Use the > arrow to switch to the next basic settings.
7. Press the menu button to save.
"Save" or "Discard" appears on the display.

List of settings

This list tells you all the basic settings and how to change them. Depending on the model of the appliance you own, the display will show only those settings that apply to your appliance.

You can change the following settings:

Setting	Options
Select language	Additional languages possible
Time of day	Sets the current time
Date	Sets the current date
Audible signal duration	Short (30 s)
	Medium (1 m)
	Long (5 m)
Button tone	Switched off (button tone still sounds when switching on/off using the "On/off" button)
	Switched on
Display brightness	Can be adjusted to one of five different levels
Clock display	Digital with date
	Analogue
	Off
Lighting	On during operation
	Off during operation
Continue automatically	When closing the door
	Do not continue automatically (press the Stop/Start button)
Operation after switching on	Main menu
	Types of heating
	Microwave
	Microwave combination
	Dishes*
Night-time dimming	Switched off
	Switched on (display dimmed between 10 p.m. and 5.59 a.m.)
Brand name logo	Display
	Do not display
Fan run-on time	Recommended
	Minimum
Sabbath mode	Switched on
	Switched off
Factory settings	Restore

*) Included, depending on appliance model

Note: Changes to the language, button tone and display brightness settings take effect immediately. All other changes take effect after the settings have been saved.

Changing the time

You can change the time in the basic settings.

For example: Changing from summer to winter time.

1. Press the On/Off button.
2. Press the menu button.
The operating modes menu opens.
3. Touch "Settings".

4. Use the > arrow to switch to "Clock".
5. Use the rotary selector to change the time.
6. Press the menu button.
"Save" or "Discard" appears on the display.

Power cut

Following a long power cut, the settings for initial use are shown in the display.

Reset the language, time and date.



Microwave

You can use the microwave to cook, heat up or defrost food quickly. The microwave can be used on its own, or in combination with a type of heating.

To ensure optimum use of the microwave, please observe the notes on cookware and familiarise yourself with the data in the application tables at the end of the instruction manual.

Cookware

Not all cookware is suitable for microwaves. To ensure that your food is heated and the appliance is not damaged, only use cookware that is suitable for microwaves.

Heat-resistant cookware made of glass, glass ceramic, porcelain or heat-resistant plastic is suitable. These materials allow microwaves to pass through. You can also use ceramic if it has been fully glazed and has no cracks.

You can also use serving dishes. This saves you having to transfer food from one dish to another. You should only use cookware with decorative gold or silver trim if the manufacturer guarantees that they are suitable for use in microwaves.

To bake in combined operation, you can use ordinary metal baking tins. This means that the cake is also browned from below.

Metal dishes are not suitable for other applications. Metal does not allow microwaves to pass through. Food in covered metal containers will remain cold.

Caution!

Creation of sparks: Metal (e.g. a spoon in a glass) must be kept at least 2 cm from the cooking compartment walls and the inside of the door. Sparks may irreparably damage the glass on the inside of the door.

Cookware test

Never switch on the microwave unless there is food inside. The short cookware test is the only exception to this rule.

Perform the following test if you are unsure whether your cookware is suitable for use in the microwave.

1. Heat the empty cookware at maximum power for ½ to 1 minute.
2. Check the temperature of the cookware during this time.

The cookware should remain cold or warm to the touch.

The cookware is unsuitable if it becomes hot or sparks are generated.

In this case, stop the test.

⚠ Warning – Risk of burns!

The accessible parts become very hot when in operation. Never touch hot parts. Keep children at a safe distance.

Accessories included

Only the wire rack provided is suitable when using the microwave only. If you use the universal pan or the baking tray, this may create sparks, which may damage the cooking compartment.

When using the appliance in combination with the microwave or "Dishes" mode, you can use the universal pan, baking tray or any other accessories that have been included with the appliance.

When using the microwave, it is best to insert accessories at level 1, unless otherwise specified.

Microwave power settings

A variety of microwave power settings that are suitable for different types of food and food preparation are available.

A cooking time must always be set to operate the microwave. You can either apply the default cooking time or adjust it in the relevant menu.

Setting	Food	Maximum cooking time
90 W	For defrosting delicate foods	1 hr 30 mins
180 W	For defrosting and continued cooking	1 hr 30 mins
360 W	For cooking meat and for heating delicate foods	1 hr 30 mins
600 W	For heating and cooking food	1 hr 30 mins
Max.	For heating liquids	30 mins





The maximum setting is for heating liquids. After a certain period, the microwave's power output is reduced to below maximum to protect the appliance. After a cooling period, the microwave's full power will be available once more.

Setting the microwave combined with a type of heating

Not all types of heating are suitable for combining with the microwave.

You can set output settings from 90 W to 360 W.

Suitable types of heating:

	4D hot air
	Top/bottom heating
	Hot air grilling
	Grill, large area
	Grill, small area

1. Press the menu button.
The operating modes menu opens.
2. Select the "Microwave combination" field.
A type of heating, temperature, microwave output setting and cooking time are suggested.
3. Touch the appropriate field and use the rotary selector to set the required values.
4. Press the Start/Stop button to start.
The cooking time starts counting down.

You can change the values at any time. To do so, touch the appropriate field and use the rotary selector to change the values.

The cooking time has elapsed

A signal sounds. The microwave operation has finished. |→| 0 min 00 s appears in the display and "Finished" appears in the status bar. You can cancel the audible signal before it has finished by pressing the ⏸ button. If you want to set a microwave output setting again, touch the appropriate field and enter a cooking time. The operation starts again.

Pausing the operation

Press the start/stop button: The oven is paused. Press the start/stop button again; the operation continues.

Open the appliance door: The operation is interrupted. After closing the door: The operation continues.

Cancelling the operation

Press the On/Off button.

Setting the microwave

To achieve optimum results with the microwave, always insert the wire rack at shelf position 1.

1. Press the Menu button.
The Operating Modes menu opens.
2. Select the "Microwave" field.
A microwave output setting and cooking time are suggested.
3. Use the rotary selector to set the microwave output setting and/or cooking time.
4. Start the microwave using the Start/Stop button.
The cooking time starts counting down.

You can change the values at any time. To do so, touch the appropriate field and use the rotary selector to change the values.

The cooking time has elapsed

A signal sounds. The microwave operation has finished. |→| 0 min 00 s appears in the display and "Finished" appears in the status bar. You can cancel the audible signal before it has finished by pressing the ⏸ button. If you want to set a microwave output setting again, touch the appropriate field and enter a cooking time. The operation starts again.

Pausing the operation

Press the start/stop button: The oven is paused. Press the start/stop button again; the operation continues.

Open the appliance door: The operation is interrupted. After closing the door, press the start/stop button. The operation continues.

Cancelling the operation

Press the On/Off button.

Dry

With the "Dry" operating mode, the cooking compartment is heated up and the moisture in the cooking compartment evaporates. Use the drying function after every microwave operation.

1. Press the menu button.
The operating modes menu opens.
2. Select the "Dry" operating mode.
3. Press the Start/Stop button to start.
The drying function starts and ends automatically after 10 minutes.

Open the appliance door for 1 to 2 minutes so that the moisture can escape.



Sabbath mode

With the Sabbath mode, a cooking time of up to 74 hours can be set. You can keep the food in the cooking compartment warm without having to switch the oven on or off.

Starting Sabbath mode

Prerequisite: "Sabbath mode activated" is activated in the basic settings. → *"Basic settings" on page 16*

The cooking compartment heats up with top/bottom heating and a temperature between 85 °C and 140 °C.

1. Press the On/Off button.
A type of heating and a temperature are suggested in the display.
2. Turn the rotary selector anti-clockwise and select the "Sabbath mode" type of heating.
3. Touch the suggested temperature and set the temperature using the rotary selector.
4. Press the  button to open the time-setting options menu and touch the "Cooking time" field.
25:00 hours are suggested.
5. Use the rotary selector to set the required cooking time.
6. Press the Start/Stop button to start.
You can see the cooking time counting down in the status bar.

The cooking time has elapsed

A signal sounds. The oven stops heating. "Finished" appears in the status bar.

Setting a later end time

It is not possible to set a later end time.

Cancelling Sabbath mode

Press the On/Off button. All settings are deleted. You can apply new settings.



Cleaning function

The self-cleaning surfaces in the cooking compartment are cleaned when the operating mode is set to "Cleaning function".

The self-cleaning surfaces (back panel, ceiling panel and side panels) are coated with a porous, matt ceramic material. This coating absorbs and breaks down splashes from baking, roasting and grilling while the oven is in operation. If the surfaces no longer clean themselves adequately and dark patches appear, the surfaces can be cleaned by the cleaning function.

Note: The appliance records the number of times it is used. The appliance indicates when it has reached a point in time after which cleaning is recommended. The recommendation is displayed until the cleaning function has finished.

If you do not act on this recommendation, the self-cleaning surfaces may become damaged.

If your appliance is already prematurely very dirty or if you notice dark patches on the back panel, do not wait until your appliance recommends cleaning to do so.

This is because the more often the appliance is cleaned, the longer the self-cleaning surfaces will retain their cleaning capability. You can clean your appliance at any time as required using the cleaning function.

Prior to initiating the cleaning function

Remove shelves, rails, accessories and ovenware from the cooking compartment.

Cleaning the cooking compartment floor and the inside of the appliance door

Remove the worst dirt from the cooking compartment floor, the inside of the appliance door and the interior lighting. Otherwise, patches will appear that can no longer be removed.

Caution!

Do not use oven cleaner on the self-cleaning surfaces. This will damage the surfaces. If oven cleaner does come into contact with these surfaces, dab it off immediately with water and a sponge cloth. Please to not rub or use any abrasive cleaning materials.

Setting the cleaning function

Cleaning lasts 60 minutes.
The duration cannot be changed.

1. Press the menu button.
The operating modes menu opens.
2. Select the "Cleaning function" operating mode.
If you touch the "Next" field, information on the cleaning operation is displayed.

- Press the "Start/stop" button to start the cleaning operation.

You can see the duration counting down in the status bar.

Keep the kitchen ventilated while cleaning is in progress.

Once the cleaning has finished

An audible signal sounds. The oven stops heating. "Finished" appears in the status bar. Use the  button to switch off the audible signal. "Appliance cooling down" appears in the status bar.

Cancelling cleaning

Press the On/Off button. All settings are deleted. You can implement new settings.

Caution!

The cleaning recommendation is not reset. The recommendation to run the cleaning function appears on the display.

You can set the cleaning to run overnight

In the section "Time settings", you can find out how to delay the end time. This allows you to use the oven at any time throughout the day. → "Time-setting options" on page 15

Once the cleaning function has ended

Once the cooking compartment has cooled down, wipe down the cooking compartment with a damp cloth if necessary.

Note: During operation and while the cleaning function is active, reddish patches may form on the surfaces. This is not rust, but food residues. These patches are not hazardous to your health and do not limit the cleaning capacity of the self-cleaning surfaces.

Cleaning agent

With good care and cleaning, your appliance will retain its appearance and remain fully functioning for a long time to come. We will explain here how you should correctly care for and clean your appliance.

Suitable cleaning agents

To ensure that the different surfaces are not damaged by using the wrong cleaning agent, observe the information in the table. Depending on the appliance model, not all of the areas listed may be on/in your appliance.

Caution!

Risk of surface damage

Do not use:

- Harsh or abrasive cleaning agents,
- Cleaning agents with a high alcohol content,
- Hard scouring pads or cleaning sponges,
- High-pressure cleaners or steam cleaners,
- Special cleaners for cleaning the appliance while it is hot.

Wash new sponge cloths thoroughly before use.

Tip: Highly recommended cleaning and care products can be purchased through the after-sales service. Observe the respective manufacturer's instructions.

Warning – Risk of burns!

The appliance becomes very hot. Never touch the interior surfaces of the cooking compartment or the heating elements. Always allow the appliance to cool down. Keep children at a safe distance.

Area	Cleaning
Appliance exterior	
Stainless steel front	Hot soapy water: Clean with a dish cloth and then dry with a soft cloth. Remove flecks of limescale, grease, starch and albumin (e.g. egg white) immediately. Corrosion can form under such flecks. Special stainless steel cleaning products suitable for hot surfaces are available from our after-sales service or from specialist retailers. Apply a very thin layer of the cleaning product with a soft cloth.
Plastic	Hot soapy water: Clean with a dish cloth and then dry with a soft cloth. Do not use glass cleaner or a glass scraper.
Painted surfaces	Hot soapy water: Clean with a dish cloth and then dry with a soft cloth.
Control panel	Hot soapy water: Clean with a dish cloth and then dry with a soft cloth. Do not use glass cleaner or a glass scraper.

Door panels	Hot soapy water: Clean with a dish cloth and then dry with a soft cloth. Do not use a glass scraper or a stainless steel scouring pad.
Door handle	Hot soapy water: Clean with a dish cloth and then dry with a soft cloth. If descaler comes into contact with the door handle, wipe it off immediately. Otherwise, any stains will not be able to be removed.
Appliance interior	
Enamel surfaces and self-cleaning surfaces	Observe the instructions for the surfaces of the cooking compartment that follow the table.
Glass cover for the interior lighting	Hot soapy water: Clean with a dish cloth and then dry with a soft cloth. If the cooking compartment is heavily soiled, use oven cleaner.
Door seal Do not remove.	Hot soapy water: Clean with a dish cloth. Do not scour.
Stainless steel door cover	Stainless steel cleaner: Observe the manufacturer's instructions. Do not use stainless steel care products. Remove the door cover for cleaning.
Stainless steel interior door frame	Stainless steel cleaner: Observe the manufacturer's instructions. This can be used to remove discolouration. Do not use stainless steel care products.
Rails	Hot soapy water: Soak and clean with a dish cloth or brush.
Pull-out system	Hot soapy water: Clean with a dish cloth or a brush. Do not remove the lubricant while the pull-out rails are pulled out – it is best to clean them when they are pushed in. Do not clean in the dishwasher.
Accessories	Hot soapy water: Soak and clean with a dish cloth or brush. If there are heavy deposits of dirt, use a stainless steel scouring pad.

Notes

- Slight differences in colour on the front of the appliance are caused by the use of different materials, such as glass, plastic and metal.
- Shadows on the door panels, which look like streaks, are caused by reflections made by the interior lighting.
- Enamel is baked on at very high temperatures. This can cause some slight colour variation. This is normal and does not affect operation. The edges of thin trays cannot be completely enamelled. As a result, these edges can be rough. This does not impair the anti-corrosion protection.

Surfaces in the cooking compartment

The back wall, ceiling and side parts in the cooking compartment are self-cleaning. You can tell this from the rough surface.

The cooking compartment floor is enamelled and has smooth surfaces.

Cleaning enamelled surfaces

Clean the smooth enamelled surfaces with a dish cloth and hot soapy water or a vinegar solution. Then dry with a soft cloth.

Soften baked-on food residues with a damp cloth and soapy water. Use stainless steel wire wool or oven cleaner to remove stubborn dirt.

Leave the cooking compartment open to dry after cleaning.

Note: Food residues can cause white deposits to form. These are harmless and do not affect how the appliance works. You can remove these residues using lemon juice if required.

Cleaning self-cleaning surfaces

The self-cleaning surfaces are coated with a porous, matte ceramic layer. This coating absorbs and dispels splashes from baking and roasting while the appliance is in operation.

If the self-cleaning surfaces no longer clean themselves sufficiently and dark stains appear, they can be cleaned using the cleaning function. To do this, refer to the information in the relevant section. → "*Cleaning function*" on page 19

Caution!

Do not use oven cleaner on self-cleaning surfaces. This will damage the surfaces. If oven cleaner does get onto these surfaces, dab it off immediately using water and a sponge cloth. Do not rub the surface and do not use abrasive cleaning aids.

Keeping the appliance clean

Always keep the appliance clean and remove dirt immediately so that stubborn deposits of dirt do not build up.

Tips

- Clean the cooking compartment after each use. This will ensure that dirt cannot be baked on.
- Always remove flecks of limescale, grease, starch and albumin (e.g. egg white) immediately.
- Use the universal pan for baking very moist cakes.
- Use suitable ovenware for roasting, e.g. a roasting dish.

Rails

With good care and cleaning, your appliance will retain its appearance and remain fully functional for a long time to come. This will tell you how to remove the shelves and clean them.

Detaching and refitting the rails

Warning – Risk of burns!

The rails become very hot. Never touch the hot rails. Always allow the appliance to cool down. Keep children away from the appliance.

Detaching the rails

1. Push the rail to the front and up (fig. **1**)
2. and detach it (fig. **2**).

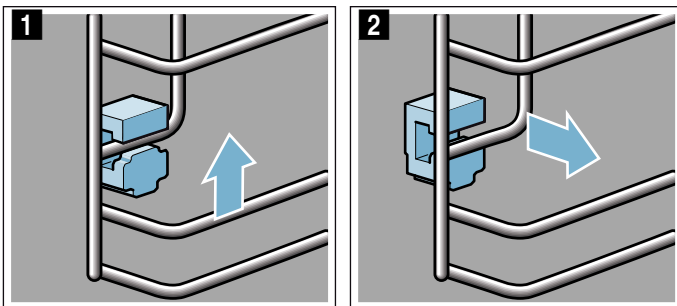

3. Then swing the entire rail outwards **a** and detach it at the rear **b** (fig. **3**).

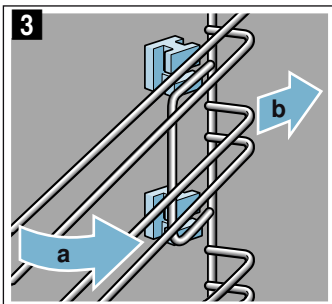

Clean the rails with cleaning agent and a sponge. For stubborn deposits of dirt, use a brush.

Inserting the holders

If the holders fall out when you remove the rails, these must be re-inserted.

1. The holders at the front differ from those at the rear (fig. **1**).
2. Use the hook to mount the front holder at the top into the round hole **a**, set it at a slight incline, attach it at the bottom, and straighten it **b** (fig. **2**).

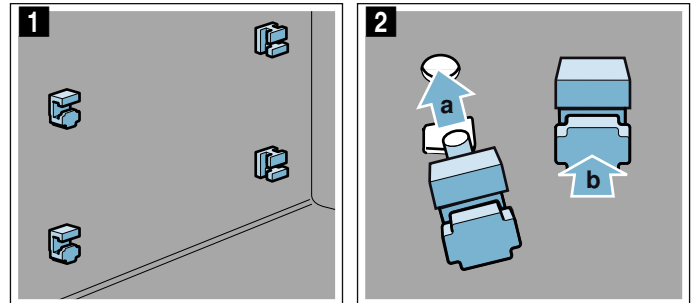

3. Use the hook to attach the rear holder into the upper hole **a** and push it into the lower hole **b** (fig. **3**).

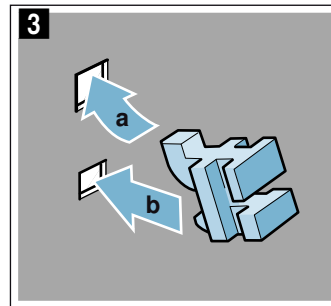

Attaching the rails

When hanging the rails, ensure that the sloping edge is at the top of the rail.

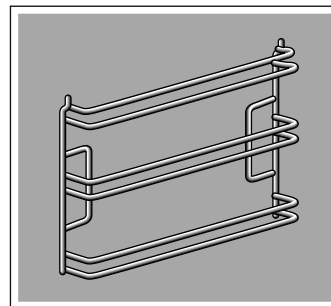

The rails fit both the left and right sides.

1. Hold the rear of the frame at an angle, and mount it at the top and bottom **a** (fig. **1**).
2. Pull the rail forwards (fig. **2**).

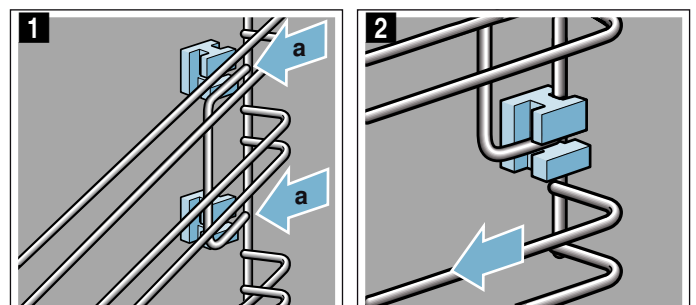

3. Then fold it forwards and insert it (fig. 3)
4. and push it downwards (fig. 4).

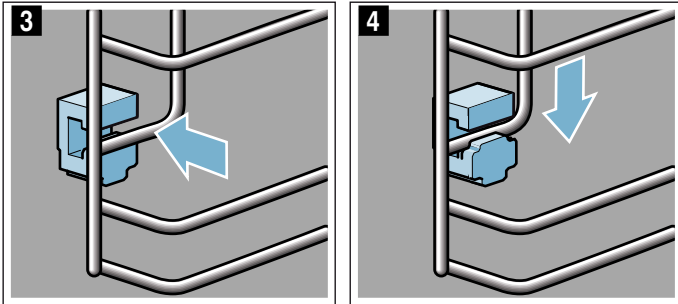

Appliance door

With good care and cleaning, your appliance will retain its appearance and remain fully functional for a long time to come. This will tell you how to clean the appliance door.

Removing the door cover

The stainless-steel inlay in the door cover may become discoloured. To carry out thorough cleaning, you can remove the cover.

1. Open the appliance door slightly.
2. Press on the right and left side of the cover (fig. 1).
3. Remove the cover (fig. 2).

Close the appliance door carefully

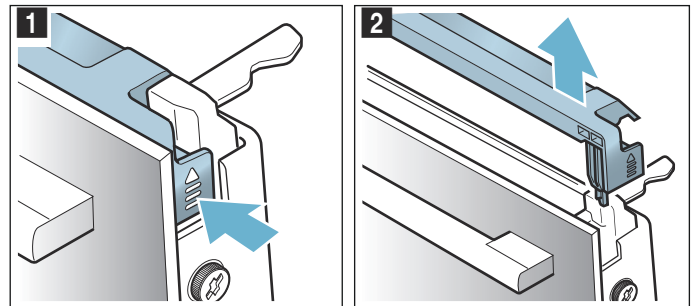

Note: Clean the stainless-steel inlay in the cover with a stainless-steel cleaning agent. Clean the rest of the door cover with soapy water and a soft cloth.

4. Open the appliance door again slightly. Put the cover back in place and press on it until it clicks audibly into place (fig. 3).

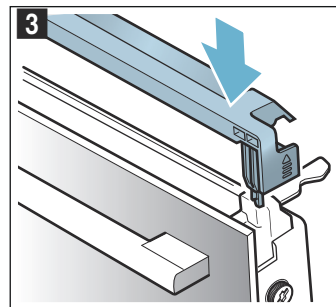

5. Close the appliance door.

Removing and fitting the door panels

To facilitate cleaning, you can remove the glass panels from the appliance door.

Removing the door panels from the appliance

1. Open the appliance door slightly.
2. Press on the right and left side of the cover (fig. 1).
3. Remove the cover (fig. 2).

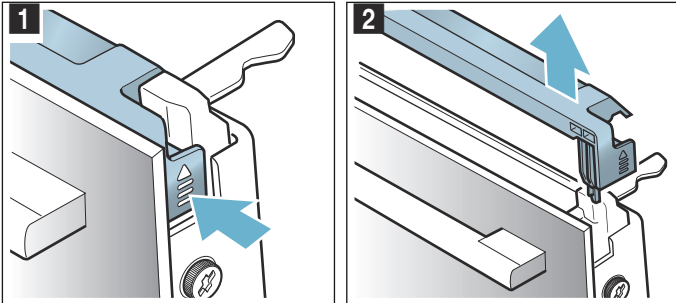

4. Undo and remove the screws on the left and right of the appliance door (fig. 3).
5. Before closing the door again, trap a tea towel that has been folded several times in the door (fig. 4). Pull out the front panel upwards and lay it on a flat surface with the door handle facing downwards.

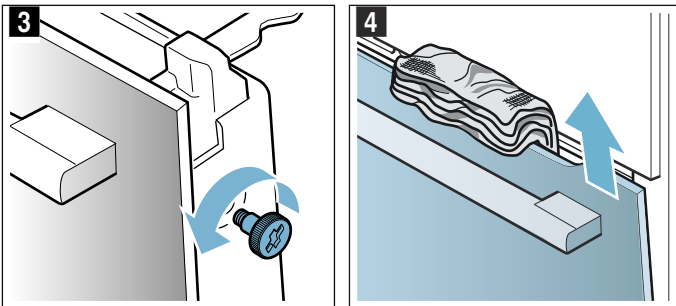

Clean the panels with glass cleaner and a soft cloth.

⚠ Warning – Risk of serious damage to health!

If the screws are loosened, the safety of the appliance can no longer be guaranteed. Microwave energy may escape. Never loosen the screws.

Do not unscrew the four black screws on the frame (fig. 5).

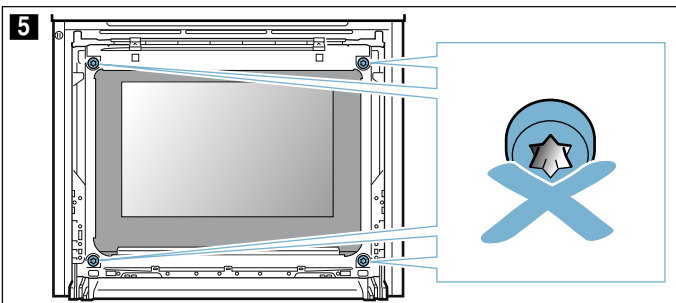

⚠ Warning **Risk of injury!**

- Scratched glass in the appliance door may develop into a crack. Do not use a glass scraper, sharp or abrasive cleaning aids or detergents.

- The hinges on the appliance door move when opening and closing the door, and you may be trapped. Keep your hands away from the hinges.

Fitting the door panels on the appliance

1. Insert the front panel downwards into the retainers (fig. 1).
2. Close the front panel until both upper hooks are opposite the opening (fig. 2).

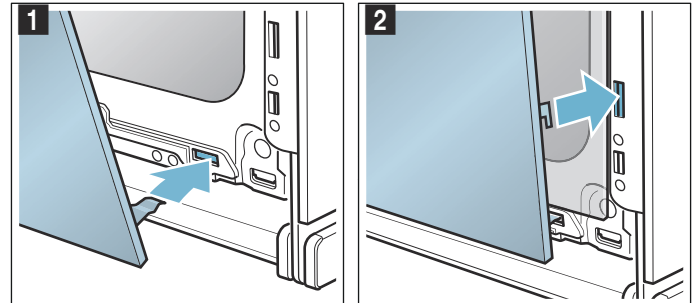

3. Press the front panel down until it clicks audibly into place (fig. 3).
4. Open the appliance door again slightly and remove the tea towel.
5. Screw both screws back in on the left and right.
6. Put the cover back in place and press on it until it clicks audibly into place (fig. 4).

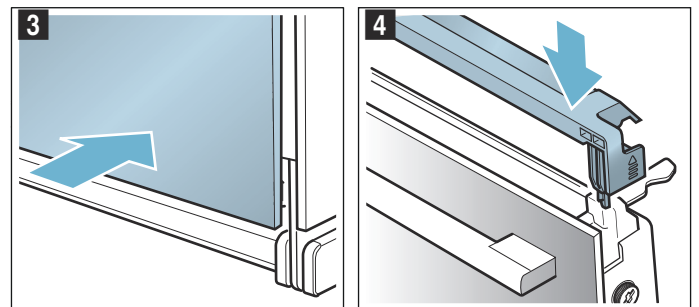

7. Close the appliance door.

Caution!

Do not use the cooking compartment again until the panels have been correctly fitted.



Trouble shooting

If a fault occurs, there is often a simple explanation. Before calling the after-sales service, please refer to the fault table and attempt to correct the fault yourself.

Note: If a dish does not turn out as well as you had hoped, refer to the table section at the end of the instruction manual, where you will find plenty of tips and

Fault table

If an error message beginning with 'E' is shown, e.g. E0111, switch the appliance off and then on again. If

Fault	Possible cause	Information/remedial action
The appliance does not work	The fuse is faulty	Check in the fuse box to make sure that the fuse for the appliance is in working order
	Power cut	Check whether other kitchen appliances are working
Although the appliance is switched on, it cannot be operated; the  symbol is shown in the display	The child lock is activated	Press and hold the  button until the  symbol goes out
The cooking compartment does not heat and "Demo mode on" is shown in the display	The appliance is in demo mode	Switch off the fuse in the fuse box and switch it back on again after approx. 10 seconds. Switch on the appliance and select "Demo mode off" in the settings.
The appliance will not start and "Cooking compartment too hot" appears on the display	The cooking compartment is too hot for the selected dish or type of heating	Allow the cooking compartment to cool down and start again
The interior lighting has failed	The LED bulb is defective	Call the after-sales service

Maximum operating time exceeded

Your appliance automatically ends the operation if no duration has been set and the setting has not been changed for a long time.

The point at which this occurs depends on the temperature or grill setting that has been set.

A message appears on the display on the appliance to say that the operation is being ended automatically. The operation is then cancelled.

To use the appliance again, first switch it off. To switch the appliance back on again set the required operation.

Tip: Set a cooking time so that the appliance does not switch off when you do not want it to, e.g. with an extremely long preparation time. The appliance heats up until the set cooking time has elapsed.

information. → "Tested for you in our cooking studio" on page 28

Warning – Risk of electric shock!

Incorrect repairs are dangerous. Repairs may only be carried out and damaged power cables replaced by one of our trained after-sales technicians. If the appliance is defective, unplug the appliance from the mains or switch off the circuit breaker in the fuse box. Contact the after-sales service.

this message appears again, contact the after-sales service.

Cooking compartment bulbs

To light the interior of your cooking compartment, your appliance has one or more long-life LED bulbs.

However, if ever an LED bulb or the bulb's glass cover is defective, call the after-sales service. The lamp cover must not be removed.

Customer service

Our after-sales service is there for you if your appliance needs to be repaired. We will always find an appropriate solution, also in order to avoid after-sales personnel having to make unnecessary visits.

E number and FD number

When calling us, please quote the full product number (E no.) and the production number (FD no.) so that we can provide you with the correct advice. The rating plate bearing these numbers can be found when you open the appliance door.

If your appliance operates with steam, you will find the rating plate on the right-hand side behind the panel.



To save time, you can make a note of the numbers for your appliance and the telephone number of the after-sales service in the space below in case you need them.

E no.	FD no.

After-sales service

Please note that a visit from an after-sales service engineer is not free of charge in the event that the appliance has been misused, even during the warranty period.

Please find the contact data of all countries in the enclosed customer service list.

To book an engineer visit and product advice

GB 0344 892 8999

Calls charged at local or mobile rate.

IE 01450 2655

0.03 € per minute at peak. Off peak 0.0088 € per minute.

Rely on the professionalism of the manufacturer. You can therefore be sure that the repair is carried out by trained service technicians who carry original spare parts for your appliances.

Dishes

You can use the "Dishes" operating mode to prepare a wide variety of food. The appliance chooses the optimal setting for you.

To achieve good results, the cooking compartment must not be too hot for the type of food you have selected. If it is, a message will appear on the display. Allow the cooking compartment to cool down and start again.

Information on the settings

- The cooking result depends on the quality of the food and the size and type of cookware. For an optimal cooking result, use food that is in good condition and chilled meat only. For frozen food, use food straight out of the freezer only.
- For some food, a temperature, heating mode and cooking time is suggested. The temperature and the cooking time can be changed according to your requirements.
- For other dishes, you will be asked to enter the weight. Always enter the total weight unless the appliance asks for something different. The appliance will then apply the time and temperature settings for you. It is not possible to set weights outside of the intended weight range.
- When roasting dishes for which the appliance will apply the temperature selection for you, temperatures of up to 300 °C can be saved. Therefore, make sure that you use cookware that is sufficiently heat resistant.
- Information is provided, e.g. on cookware, shelf position or the addition of liquid when cooking meat. Some food requires turning or stirring, etc., during cooking. This is shown in the display shortly after operation starts. An audible signal will remind you at the right time.
- Information on the right kind of cookware to use and tips and tricks for the preparation can be found at the end of the instruction manual. → "Tested for you in our cooking studio" on page 28

Microwave

For some food, the microwave is automatically activated. Using the microwave significantly reduces cooking time – cooking time is virtually cut in half. The appliance instructs you to use cookware that is suitable for the microwave. The "Microwave" section provides information on the type of cookware that is suitable. → "Microwave" on page 17

Selecting a dish

The dishes are arranged in a uniform structure:

- Category
- Food
- Dish

The following table lists the categories with the corresponding food. One or more dishes are listed beside each food.

Categories	Food
Cake	Cakes in tins
	Cakes on baking trays
	Small baked items
	Biscuits
Bread, bread rolls	Bread
	Bread rolls
Pizza, savoury cakes	Pizza
	Savoury cakes, quiches
Bakes, soufflés	Bake, savoury, fresh, cooked ingredients
	Lasagne, fresh
	Potato gratin, raw ingredients, 4 cm deep
	Bake, sweet, fresh
Frozen products	Soufflé in individual moulds
	Pizza
	Bread rolls
	Bakes
	Potato products
Poultry	Poultry, fish
	Chicken
	Duck, goose
Meat	Turkey
	Pork
	Beef
	Veal
	Lamb
	Game
Fish	Meat dishes
	Fish
Side dishes, vegetables	Fish fillets
	Vegetables
	Potatoes
	Rice
Defrosting food	Cereals
	Bread, bread rolls
	Cake
	Meat, poultry
	Fish

Applying settings for dishes

You will be guided through the entire setting process for your chosen food. Always touch the "Next" field.

1. Press the menu button.
The operating modes menu will open.
2. Select "Dishes" mode.
The first category will appear on the display.
3. Use the rotary selector to select the category you require.
4. Touch the "Next" field.
5. Use the rotary selector to select the food.
6. Touch the "Next" field.
7. Use the rotary selector to select the dish.
8. Touch the "Next" field.
9. Turn the rotary selector to set the weight.
Note: Touch the "Tip" field for information on the best shelf position, cookware, etc. to use.
10. Press the Start/Stop button to start.

The setting has ended

A signal sounds. "Finished" appears in the status bar. The oven stops heating. You can cancel the audible signal early using the  button.

If you are not satisfied with the cooking result, you can increase the cooking time again. Touch the "Extend cooking time" field. A cooking time is suggested. However, you can change this if you want.

If you are satisfied with the cooking result, touch "Finish". "Enjoy your meal" appears in the display.

Cancelling the setting

Press the On/Off button. All settings are deleted. You can implement new settings.

Setting a later end time

For some dishes, it is possible to set a later end time. You can find out how to set a later end time by looking in the time-setting options. → "Time-setting options" on page 15

Once you have set an end time, the display shows the waiting time. The status bar shows the time at which operation is to end. None of the settings can be changed. Please remember that easily spoiled foods must not be allowed to remain in the cooking compartment for too long.

Tested for you in our cooking studio

Here, you can find a selection of dishes and the ideal settings for them. We will show you which type of heating and temperature are best suited to your dish. You will get information on suitable cooking accessories and the height at which they should be placed in the oven. You will also get tips about cookware and preparation methods.

Note: A lot of steam can build up in the cooking compartment when cooking food. Your appliance is very energy-efficient and radiates very little heat to its surroundings during operation. Due to the high difference in temperature between the appliance interior and the external parts of the appliance, condensation may build up on the door, control panel or adjacent kitchen cabinet panels. This is a normal physical phenomenon. Condensation can be reduced by preheating the oven or opening the door carefully.

Silicone moulds

For the best cooking results, we recommend dark-coloured metal baking tins/dishes.

Nevertheless, if you wish to use silicone moulds, follow the manufacturer's instructions and recipes. Silicone moulds are often smaller than normal baking tins. Quantity and recipe specifications may vary.

Cakes and small baked items

Your appliance offers you a range of heating types for the preparation of cakes and small baked items. You can find the ideal settings for many dishes in the settings tables.

Also refer to the notes in the section on allowing dough to rise.

Only use original accessories supplied with your appliance. These have been tailored to the cooking compartment and the operating modes of your appliance.

Baking in combination with a microwave

If you bake in combination with a microwave, you can reduce the cooking time considerably.

Always use heat-resistant cookware that is suitable for use in microwaves. Observe the notes on cookware suitable for microwaves. → *"Microwave" on page 17*

In combined operation, you can use conventional baking tins made from metal. If sparks form between the baking tin and the wire rack, check whether the baking tin is clean on the outside. Change the position of the baking tin on the wire rack. If this does not help, continue baking without the microwave. The baking time will be extended.

If you use baking tins/dishes made from plastic, ceramic or glass, the baking time indicated in the

settings tables will be reduced. The cake will not brown as much underneath.

Baking in combination with a microwave is only possible on one level.

Shelf positions

Use the indicated shelf positions.

Baking on one level

When baking on one level, use the following shelf position:

- Level 1

Baking on two levels

Use 4D hot air. Baked items that are placed into the oven on trays or in baking tins/dishes at the same time will not necessarily be ready at the same time.

- Universal pan: Level 3
Baking tray: Level 1
- Baking tins/dishes on the wire rack
First wire rack: Level 3
Second wire rack: Level 1

By preparing several dishes at the same time, you can make energy savings of up to 45 per cent. Position baking tins/dishes next to one another or offset and vertically stacked in the cooking compartment.

Accessories

Ensure that you always use suitable accessories and that they are placed in the oven the right way around.

Wire rack

Slide the wire rack in with the embossed "microwave" facing the appliance door, and the curved lip pointing downwards. Always place ovenware, tins and dishes on the wire rack.

Universal pan or baking tray

Slide the universal pan or the baking tray in carefully as far as the limit stop with the bevelled edge facing the appliance door.

When baking moist cakes or pastries with many toppings, use the universal pan so that any excess liquid does not overflow and make the cooking compartment dirty.

Baking tins

Dark- coloured metal baking tins are most suitable.

Tinplate baking tins, ceramic dishes and glass dishes extend baking time and mean that the baked item will not brown evenly.

Greaseproof paper

Only use greaseproof paper that is suitable for the selected temperature. Always cut greaseproof paper to size.

Recommended setting values

The table lists the optimal heating type for various baked items. The temperature and baking time depend on the amount and consistency of the dough/mixture. For this reason, the table specifies setting ranges. Try using the lower values to start with. A lower temperature will result in more even browning. You can use a higher setting next time if necessary.

Note: Baking times cannot be reduced by using higher temperatures. Cakes or small baked items would only be cooked on the outside, and would not be fully baked in the middle.



The setting values apply to food that is placed into a cold cooking compartment; by doing this, you can make energy savings of up to 20 per cent. If you preheat the oven, you can reduce the indicated baking times by several minutes.

























Preheating is necessary for selected food, and this is indicated in the table. Do not place your food or accessories into the cooking compartment until it has finished preheating.

If you wish to follow one of your own recipes when baking, you should use the setting values listed for similar baked items in the table as reference. Additional information can be found in the baking tips listed after the settings table.

Remove unused accessories from the cooking compartment. This will ensure that you achieve the best possible cooking results and energy savings of up to 20 per cent.

Types of heating used:

-  4D hot air
-  Top/bottom heating
-  Pizza setting

Dish	Accessories/cookware	Shelf position	Type of heating	Temperature in °C	MW power in watts	Cooking time in mins.
Cakes in tins						
Sponge cake, simple	Ring tin/cake tin	1		150-170	-	55-70
Sponge cake, simple	Ring tin/cake tin	1		160-180	90	30-40
Sponge cake, delicate	Ring tin/cake tin	1		150-170	-	60-80
Fruit flan made from sponge mixture, delicate	Ring cake tin	1		160-180	-	45-60
Fruit flan made from sponge mixture, delicate	Ring cake tin	1		170-190	90	35-45
Sponge flan base	Flan base tin	1		150-170	-	20-40
Fruit tart or cheesecake with short-crust pastry base	Springform cake tin, diameter 26 cm	1		160-170	-	65-85
Fruit tart or cheesecake with short-crust pastry base	Springform cake tin, diameter 26 cm	1		160-180	180	30-40
				100	-	20
Swiss flan	Pizza tray	1		200-220	-	40-50
Tart	Flan-base cake tin, black	1		190-210	-	25-40
Bundt yeast cake	Ring cake tin	1		150-160	-	65-75
Yeast cake in springform cake tin	Springform cake tin, diameter 28 cm	1		150-160	-	25-35
Sponge base, 2 eggs	Flan base tin	1		170-180	-	20-30
Sponge flan, 3 eggs	Springform cake tin, diameter 26 cm	1		160-170*	-	25-35
Sponge flan, 6 eggs	Springform cake tin, diameter 28 cm	1		150-170*	-	30-50
Cakes on baking trays						
Sponge cake with topping	Baking tray	1		160-180	-	20-40
Sponge cake, 2 levels	Universal pan + baking tray	3+1		150-170	-	35-50
Shortcrust tart with dry topping	Baking tray	1		180-200	-	25-30
Shortcrust tart with dry topping, 2 levels	Universal pan + baking tray	3+1		150-170	-	40-55
Shortcrust tart with moist topping	Universal pan	1		160-180	-	60-80
Swiss flan	Universal pan	1		200-210	-	40-50
Yeast cake with dry topping	Baking tray	1		160-180	-	15-25
Yeast cake with dry topping, 2 levels	Universal pan + baking tray	3+1		160-170	-	25-35
Yeast cake with moist topping	Universal pan	1		180-200	-	30-45

* Preheat

** Preheat for 5 mins., do not use quick heat function

Dish	Accessories/cookware	Shelf position	Type of heating	Temperature in °C	MW power in watts	Cooking time in mins.
Yeast cake with moist topping, 2 levels	Universal pan + baking tray	3+1		150-160	-	45-60
Plaited loaf, savarin	Baking tray	1		150-160	-	35-45
Swiss roll	Baking tray	1		190-210*	-	10-15
Stollen with 500 g flour	Universal pan	1		150-160	-	50-60
Strudel, sweet	Universal pan	1		170-180	-	40-60
Strudel, frozen	Baking tray	1		190-210	-	30-45
Strudel, frozen	Universal pan	1		200-220	90	20-25
Small baked items						
Small cakes	Baking tray	1		160**	-	25-35
Small cakes	Baking tray	1		150**	-	20-30
Small cakes, 2 levels	Universal pan + baking tray	3+1		140**	-	30-40
Muffins	Muffin tray	1		170-190	-	15-30
Muffins, 2 levels	Muffin trays	3+1		150-170*	-	20-30
Small yeast cakes	Baking tray	1		160-170	-	30-40
Puff pastry	Baking tray	2		170-190*	-	20-45
Puff pastry, 2 levels	Universal pan + baking tray	3+1		170-190*	-	20-45
Choux pastry	Baking tray	1		200-220	-	30-45
Danish pastry	Baking tray	1		160-180	-	20-30
Biscuits						
Whirls	Baking tray	1		150-160**	-	20-30
Whirls	Baking tray	1		140-150**	-	25-35
Biscuits	Baking tray	2		140-160	-	15-30
Biscuits, 2 levels	Universal pan + baking tray	3+1		130-150	-	20-35
Meringue	Baking tray	2		80-90*	-	120-150
Meringue, 2 levels	Universal pan + baking tray	3+1		80-90*	-	120-180
Macaroons	Baking tray	2		90-110	-	20-40
Macaroons, 2 levels	Universal pan + baking tray	3+1		90-110	-	20-40

* Preheat

** Preheat for 5 mins., do not use quick heat function

Tips on baking

You want to find out whether the cake is completely cooked in the middle.	Push a cocktail stick into the highest point on the cake. If the cocktail stick comes out clean with no dough residue, the cake is ready.
The cake collapses.	Next time, use less liquid. Alternatively, set the temperature to be 10 °C lower and extend the baking time. Adhere to the specified ingredients and preparation instructions in the recipe.
The cake has risen in the middle but is lower around the edge.	Only grease the base of the springform cake tin. After baking, loosen the cake carefully with a knife.
The fruit juice overflows.	Next time, use the universal pan.
Small baked items stick to one another during baking.	There should be a gap of approx. 2 cm around each item. This gives enough space for the baked items to expand well and brown on all sides.
The cake is too dry.	Set the temperature 10 °C higher and shorten the baking time.
The cake is generally too light in colour.	If the shelf position and the cookware are correct, then you should increase the temperature if necessary or extend the baking time.
The cake is too light on top, and too dark underneath.	Bake the cake one level higher in the oven the next time.

The cake is too dark on top, and too light underneath.	Bake the cake one level lower in the oven the next time. Select a lower temperature and extend the baking time.
Cakes baked in a tray or tin are too brown at the back.	Place the baking tray in the middle of the accessories, not directly against the back wall.
The whole cake is too dark.	Select a lower temperature next time and extend the baking time if necessary.
The cake is unevenly browned.	Select a slightly lower temperature. Protruding greaseproof paper can affect the air circulation. Always cut greaseproof paper to size. Ensure that the baking tin does not stand directly in front of the openings in the cooking compartment back wall. When baking small items, you should use similar sizes and thicknesses wherever possible.
You were baking on several levels. The items on the top baking tray are darker than those on the lower baking tray.	Always select 4D hot air when baking on several levels. Baked items that are placed into the oven on trays or in baking tins/dishes at the same time will not necessarily be ready at the same time.
The cake looks good, but is not cooked properly in the middle.	Use a lower temperature and bake slightly longer; if necessary, add slightly less liquid. For cakes with a moist topping, bake the base first. Sprinkle it with almonds or breadcrumbs and then place the topping on top.
The cake cannot be turned out of the dish when it is turned upside down.	Allow the cake to cool down for 5 to 10 minutes after baking. If it still sticks, carefully loosen the cake around the edges again using a knife. Turn the cake tin upside down again and cover it several times with a cold, wet cloth. Next time, grease the baking tin/dish and sprinkle with breadcrumbs.

Bread and rolls

Your appliance offers you a range of heating types for baking bread and rolls. You can find the ideal settings for many dishes in the settings tables.

Also refer to the notes in the section on allowing dough to rise.

Only use original accessories supplied with your appliance. These have been tailored to the cooking compartment and the operating modes of your appliance.

Shelf positions

Use the indicated shelf positions.

Baking on one level

When baking on one level, use the following shelf position:

- Level 1

Baking on two levels

Use 4D hot air. Baked items that are placed into the oven on trays or in baking tins/dishes at the same time will not necessarily be ready at the same time.

- Universal pan: Level 3
Baking tray: Level 1
- Baking tins/dishes on the wire rack
First wire rack: Level 3
Second wire rack: Level 1

By preparing several dishes at the same time, you can make energy savings of up to 45 per cent. Position baking tins/dishes next to one another or offset and vertically stacked in the cooking compartment.

Accessories

Ensure that you always use suitable accessories and that they are placed in the oven the right way around.

Wire rack

Slide the wire rack in with the embossed "microwave" facing the appliance door, and the curved lip pointing

downwards. Always place ovenware, tins and dishes on the wire rack.

Universal pan or baking tray

Slide the universal pan or the baking tray in carefully as far as the limit stop with the bevelled edge facing the appliance door.

Baking tins

Dark- coloured metal baking tins are most suitable.

Tinplate baking tins, ceramic dishes and glass dishes extend baking time and mean that the baked item will not brown evenly.

Greaseproof paper

Only use greaseproof paper that is suitable for the selected temperature. Always cut greaseproof paper to size.

Frozen products

Do not use frozen products that are heavily frosted. Remove any ice on the food.

Some frozen products may be unevenly pre-baked. Uneven browning may remain even after baking.

Recommended setting values

The table lists the optimal heating type for various kinds of bread and bread roll. The temperature and baking time depend on the amount and consistency of the dough/mixture. For this reason, the table specifies setting ranges. Try using the lower values to start with. A lower temperature will result in more even browning. You can use a higher setting next time if necessary.

Note: Baking times cannot be reduced by using higher temperatures. The bread or bread rolls would only be cooked on the outside, but would not be fully baked in the middle.

The setting values apply to food that is placed into a cold cooking compartment; by doing this, you can make energy savings of up to 20 per cent. If you preheat

the oven, you can reduce the indicated baking times by several minutes.

Preheating is necessary for selected food, and this is indicated in the table. Do not place your food or accessories into the cooking compartment until it has finished preheating. Some food turns out best if it is baked in several stages. These foods are indicated in the table.

The setting values for bread dough apply to both dough placed on a baking tray and dough placed in a loaf tin.

If you wish to follow one of your own recipes when baking, you should use the setting values listed for similar baked items in the table as reference.





Remove unused accessories from the cooking compartment. This will ensure that you achieve the best















possible cooking results and energy savings of up to 20 per cent.

Caution!

Never pour water into the hot cooking compartment or place cookware containing water onto the bottom of the cooking compartment. The change in temperature can cause damage to the enamel.

Types of heating used:

-  4D hot air
-  Top/bottom heating
-  Circulated air grilling
-  Grill, large area
-  Grill, small area

Dish	Accessories	Shelf position	Type of heating	Temperature in °C/ grill setting	Cooking time in mins.
Bread					
White bread, 750 g	Universal pan or cake tin	1		210-220*	10-15
				180-190	25-35
Multigrain bread, 1.5 kg	Universal pan or cake tin	1		210-220*	10-15
				180-190	40-50
Wholemeal bread, 1 kg	Universal pan	1		210-220*	10-15
				180-190	40-50
Flatbread	Universal pan	1		250-270	20-30
Bread rolls					
Part-cooked rolls or baguette, pre-baked	Universal pan	2		200-220	10-20
Bread rolls, sweet, fresh	Baking tray	1		170-180*	15-25
Bread rolls, sweet, fresh, 2 levels	Universal pan + baking tray	3+1		150-160*	20-30
Bread rolls, fresh	Baking tray	1		180-200	25-35
Baguette, pre-baked, chilled	Universal pan	2		200-220	10-20
Bread rolls, frozen					
Part-cooked rolls or baguette, pre-baked	Universal pan	2		200-220	15-25
Lye bread, pieces of dough	Baking tray	1		220-240	15-25
Croissant, pieces of dough	Baking tray	1		150-170*	20-35
Toast					
Toast with topping, 4 slices	Wire rack	2		3	5-15
Toast with topping, 12 slices	Wire rack	2		250	5-15
Browning toast	Wire rack	3		3	3-6
* Preheat					

Pizza, quiche and savoury cakes

Your appliance offers you a range of heating types for preparing pizza, quiche and savoury cakes. You can find the ideal settings for many dishes in the settings tables.

Also refer to the notes in the section on allowing dough to rise.

Only use original accessories supplied with your appliance. These have been tailored to the cooking compartment and the operating modes of your appliance.

Baking in combination with a microwave

If you bake in combination with a microwave, you can reduce the cooking time considerably.

In combined operation, you can use conventional baking tins made from metal. If sparks form between the baking tin and the wire rack, check whether the baking tin is clean on the outside. Change the position of the baking tin on the wire rack. If this does not help, continue baking without the microwave. The baking time will be extended.

If you use baking tins/dishes made from plastic, ceramic or glass, the baking time indicated in the settings tables will be reduced. The savoury cake will not brown as much underneath.

Baking in combination with a microwave is only possible on one level.

Shelf positions

Use the indicated shelf positions.

Baking on one level

When baking on one level, use the following shelf position:

- Level 1

Baking on two levels

Use 4D hot air. Baked items that are placed into the oven on trays or in baking tins/dishes at the same time will not necessarily be ready at the same time.

- Universal pan: Level 3
Baking tray: Level 1
- Baking tins/dishes on the wire rack
First wire rack: Level 3
Second wire rack: Level 1

By preparing several dishes at the same time, you can make energy savings of up to 45 per cent. Position baking tins/dishes next to one another or offset and vertically stacked in the cooking compartment.

Accessories

Ensure that you always use suitable accessories and that they are placed in the oven the right way around.

Wire rack

Slide the wire rack in with the embossed "microwave" facing the appliance door, and the curved lip pointing downwards. Always place ovenware, tins and dishes on the wire rack.

Universal pan or baking tray

Slide the universal pan or the baking tray in carefully as

far as the limit stop with the bevelled edge facing the appliance door.

Use the universal pan for pizzas with many toppings.

Baking tins

Dark- coloured metal baking tins are most suitable.

Tinplate baking tins, ceramic dishes and glass dishes extend baking time and mean that the baked item will not brown evenly.

Greaseproof paper

Only use greaseproof paper that is suitable for the selected temperature. Always cut greaseproof paper to size.

Frozen products

Do not use frozen products that are heavily frosted. Remove any ice on the food.

Some frozen products may be unevenly pre-baked. Uneven browning may remain even after baking.

Recommended setting values

The table lists the optimal heating type for various types of food. The temperature and baking time depend on the amount and consistency of the dough/mixture. For this reason, the table specifies setting ranges. Try using the lower values to start with. A lower temperature will result in more even browning. You can use a higher setting next time if necessary.

Note: Baking times cannot be reduced by using higher temperatures. The food would only be cooked on the outside, but would not be fully baked in the middle.

The setting values apply to food that is placed into a cold cooking compartment; by doing this, you can make energy savings of up to 20 per cent. If you preheat the oven, you can reduce the indicated baking times by several minutes.





















Preheating is necessary for selected food, and this is indicated in the table. Do not place your food or accessories into the cooking compartment until it has finished preheating.

If you wish to follow one of your own recipes when baking, you should use the setting values listed for similar baked items in the table as reference.

Remove unused accessories from the cooking compartment. This will ensure that you achieve the best possible cooking results and energy savings of up to 20 per cent.

Types of heating used:

-  4D hot air
-  Top/bottom heating
-  Pizza setting
-  Intensive heat
-  coolStart function

Dish	Accessories	Shelf position	Type of heating	Temperature in °C	MW power in watts	Cooking time in mins.
Pizza						
Pizza, fresh	Baking tray	1		200-220	-	20-30
Pizza, fresh, 2 levels	Universal pan + baking tray	3+1		180-200	-	35-45
Pizza, fresh, thin base	Pizza tray	1		210-230	-	20-30
Pizza, chilled	Wire rack	1		210-230	-	10-20
Pizza, frozen						
Pizza, thin base, x 1**	Wire rack	1		-	-	-
Pizza, thin base, x 1	Universal pan	1		210-230	90	10-20
Pizza, thin base, x 2	Wire rack + baking tray	3+1		200-220	-	15-25
Pizza, deep-pan, x 1**	Wire rack	1		-	-	-
Pizza, deep-pan, x 1	Universal pan	1		180-200	90	15-25
Pizza, deep-pan, x 2	Universal pan + wire rack	3+1		160-180	-	25-35
Pizza baguette	Wire rack	1		200-220	-	20-30
Pizza baguette, x 2	Universal pan	1		180-200	90	10-20
Mini pizza**	Universal pan	1		-	-	-
Mini pizzas, x 9	Universal pan	1		210-230	90	10-20
Savoury cakes and quiches						
Savoury cakes in a tin	Springform cake tin, diameter 28 cm	1		170-190	-	60-70
Savoury cakes in a tin	Springform cake tin, diameter 26 cm	1		180-200	90	35-40
Quiche	Flan-base cake tin, black	1		190-210	-	35-55
Tarte flambée	Universal pan	1		280-300*	-	8-18
Pierogi	Ovenproof dish	1		190-200	-	40-50
Empanada de atún	Universal pan	1		180-190	-	35-45
Börek	Universal pan	1		180-200	-	35-45
* Preheat						
** Observe the information on the packaging						

Bakes and soufflés

Your appliance offers a range of heating types for preparing bakes and soufflés. You can find the ideal settings for many dishes in the settings tables.

Only use original accessories supplied with your appliance. These have been tailored to the cooking compartment and the operating modes of your appliance.

Preparing food with a microwave

If you prepare food only in a microwave or in combination with a microwave, the cooking time may be considerably reduced.

Always use heat-resistant cookware that is suitable for use in microwaves. Observe the notes on cookware suitable for microwaves. → "Microwave" on page 17

Take ready-to-eat meals out of the packaging. You can cook more quickly and evenly using cookware which is suitable for use in microwaves.

Shelf positions

Always use the indicated shelf positions.

You can prepare dishes on one level using a baking tin/dish or the universal pan.

- Baking tins/dishes on the wire rack: Level 1
- Universal pan: Level 2

You can also prepare soufflés in a water bath in the universal pan. To do so, slide the universal pan in at level 1.

By preparing several dishes at the same time, you can make energy savings of up to 45 per cent. Position

baking tins/dishes next to one another in the cooking compartment.

Accessories

Ensure that you always use suitable accessories and that they are placed in the oven the right way around.

Wire rack

Slide the wire rack in with the embossed "microwave" facing the appliance door, and the curved lip pointing downwards. Always place ovenware, tins and dishes on the wire rack.

Universal pan

Slide in the universal pan carefully as far as the limit stop, with the bevelled edge facing the appliance door.

Cookware

Use wide, shallow cookware for bakes and gratins. In deep, narrow cookware, food requires more time to cook, and the top will be darker.

Recommended setting values

In the table, you can find the ideal heating type for various bakes and soufflés. The temperature and cooking time are dependent on the quantity of food and the recipe. How well cooked a bake is will depend on the size of the cookware and the depth of the bake. Settings ranges are indicated for this reason. Try using

the lower values at first. A lower temperature results in more even browning. You can increase the temperature next time if necessary.





Note: Cooking times cannot be reduced by using higher temperatures. Bakes or soufflés would only be cooked on the outside, but would be raw in the middle.













The setting values apply to dishes placed into a cold cooking compartment. By doing so, you can make energy savings of up to 20 per cent. If you preheat the oven, the indicated cooking times will be reduced by several minutes.

If you wish to follow one of your own recipes when cooking, you can use similar dishes in the table as a reference.

Remove unused accessories from the cooking compartment. This will achieve the best possible cooking results and energy savings of up to 20 per cent.

Types of heating used:

-  4D hot air
-  Top/bottom heating
-  Circulated air grilling
-  Pizza setting
-  coolStart function

Dish	Accessories/cookware	Shelf position	Type of heating	Temperature in °C	MW power in watts	Cooking time in mins.
Bake, savoury, cooked ingredients	Ovenproof dish	1		200-220	-	35-55
Bake, savoury, cooked ingredients	Ovenproof dish	1		140-160	360	20-30
Bake, sweet	Ovenproof dish	1		170-190	-	45-60
Bake, sweet	Ovenproof dish	1		140-160	360	25-35
Lasagne, fresh, 1 kg	Ovenproof dish	1		160-180	-	50-60
Lasagne, fresh, 1 kg	Ovenproof dish	1		180-200	360	20-30
Lasagne, frozen, 400 g**	Universal pan	1		-	-	-
Lasagne, frozen, 400 g	Cookware, uncovered	1		200-210	180	20-25
Potato gratin, raw ingredients, 4 cm deep	Ovenproof dish	1		170-180	-	50-65
Potato gratin, raw ingredients, 4 cm deep	Ovenproof dish	1		170-190	360	20-25
Soufflé	Ovenproof dish	1		160-170*	-	40-50
Soufflé	Individual moulds	1		170-190	-	65-75

* Preheat

** Observe the information on the packaging

Poultry

Your appliance offers you a range of heating types for preparing poultry. You can find the ideal settings for certain dishes in the settings tables.

Roasting on the wire rack

Roasting on the wire rack is particularly well suited for larger poultry or for multiple pieces at the same time.

Slide the wire rack in at the indicated shelf position with the imprint "Microwave" facing the appliance door and the outer rail facing downwards. In addition, slide the universal pan in at the shelf position underneath with the slanted edge facing the appliance door.

Depending on the size and type of the poultry, pour up to ½ litres of water into the universal pan. Any dripping fat will be caught. You can make a sauce from these juices. This will also result in less smoke and ensure that the cooking compartment stays cleaner.

Roasting in cookware

Only use cookware which is suitable for use in an oven. Check whether the cookware fits in the cooking compartment.

Glass cookware is most suitable. Place hot glass cookware onto a dry mat after cooking. If the surface is damp or cold, the glass may crack.

Shiny roasting dishes made from stainless steel or aluminium reflect heat like a mirror and are therefore not particularly suitable. The poultry cooks slower and does not brown so well. Use a higher temperature and/or a longer cooking time.

Observe the manufacturer's instructions for your roasting cookware.

Uncovered cookware

It is best to use a deep roasting tin/dish for roasting poultry. Place the tin/dish onto the wire rack. If you do not have any suitable cookware, use the universal pan.

Covered cookware

When cooking with covered cookware, the cooking compartment remains considerably cleaner. Ensure that the lid fits well and closes properly. Place the cookware onto the wire rack.

Very hot steam may escape when opening the lid after cooking. Lift the lid at the rear, so that the hot steam can escape away from you.

Poultry can also become crispy in a covered roasting dish. To do so, use a roasting dish with a glass lid and set a higher temperature.

Roasting in combination with a microwave

Poultry is particularly well suited to being prepared in combination with a microwave. The cooking time is considerably reduced by doing so.

As opposed to conventional operation, the cooking time is based on the total weight when roasting in combination with a microwave.

Tip: If you have quantities other than those indicated in the settings tables, the following basic rule applies: double the quantity equates to roughly double the cooking time.

Always use heat-resistant cookware that is suitable for use in microwaves. Roasting dishes made from metal or Römertopf dishes are only suitable for roasting without using the microwave. Observe the notes on cookware suitable for microwaves. → "Microwave" on page 17

Grilling

Keep the appliance door closed when using the grill. Never grill with the appliance door open.

Slide the wire rack in at the indicated shelf position with the imprint "Microwave" facing the appliance door and the outer rail facing downwards. In addition, slide the universal pan in at least one shelf position lower, with the slanted edge facing the appliance door. Any dripping fat will be caught.

When grilling, try wherever possible to use pieces of food which are of a similar thickness and weight. This will allow them to brown evenly and remain succulent and juicy. Place the food to be grilled directly onto the wire rack.

Use tongs to turn the pieces of food you are grilling. If you pierce the meat with a fork, the juices will run out and it will become dry.

Notes

- The grill element switches itself continuously on and off; this is normal. The grill setting determines how frequently this occurs.
- Smoke may be produced when grilling.

Recommended setting values

In the table, you can find the ideal heating type for the kind of poultry you are cooking. The temperature and cooking time depend on the amount, composition and temperature of the food. Setting ranges are indicated for this reason. Try using the lower values at first. You can increase the temperature next time if necessary.

The setting values are based on the assumption that unstuffed, chilled, ready-to-roast poultry is placed into a cold cooking compartment. By doing so, you can make energy savings of up to 20 per cent. If you preheat the oven, the indicated cooking times will be reduced by several minutes.

In the table, you can find specifications for poultry with default values for the weight. If you wish to cook heavier poultry, use the lower temperature in every case. If cooking multiple pieces, use the weight of the heaviest piece as a reference for determining the cooking time. The individual pieces should be approximately equal in size.

A general rule: the larger the poultry is, the lower the cooking temperature and the longer the cooking time.

Turn the poultry after approx. ½ to ⅔ of the indicated time.

Note: Only use greaseproof paper that is suitable for the selected temperature. Always cut greaseproof paper to size.

Tips





- For duck or goose, pierce the skin on the underside of the wings. This allows the fat to run out.























- If using duck breast, score the skin. Do not turn duck breasts.
- When you turn poultry, ensure that the breast side or the skin side is underneath at first.
- Poultry will turn out particularly crispy and brown if you baste it towards the end of the roasting time with butter, salted water or orange juice.

Remove unused accessories from the cooking compartment. This will achieve the best possible

cooking results and energy savings of up to 20 per cent.

Types of heating used:

-  4D hot air
-  Top/bottom heating
-  Circulated air grilling
-  Grill, large area
-  coolStart function

Dish	Accessories/cookware	Shelf position	Type of heating	Temperature in °C/ grill setting	MW power in watts	Cooking time in mins.
Chicken						
Chicken, 1 kg	Cookware, uncovered	1		200-220	-	60-70
Chicken, 1 kg	Cookware, covered	1		230-250	360	25-35
Chicken breast fillet, 150 g each (grilling)	Wire rack	2		3*	-	15-20
Chicken breast fillet, x 2, 150 g each (grilling)	Cookware, uncovered	1		190-210	180	25-30
Small chicken portions, 250 g each	Wire rack	2		220-230	-	30-35
Small chicken portions, x 4, 250 g each	Cookware, uncovered	1		190-210	360	20-30
Chicken goujons, nuggets, frozen**	Universal pan	2		-	-	-
Chicken goujons, nuggets, frozen, 250 g	Universal pan	1		190-210	360	15-20
Poulard, 1.5 kg	Cookware, uncovered	1		200-220	-	70-90
Poulard, 1.5 kg	Cookware, covered	1		200-220	360	30
					180	15-25
Duck and goose						
Duck, 2 kg	Cookware, uncovered	1		180-200	-	90-110
Duck, 2 kg	Universal pan	1		170-190	180	60-80
Duck breast, 300 g each	Wire rack	2		230-250	-	25-30
Goose, 3 kg	Cookware, uncovered	1		160-170	-	120-150
Goose, 3 kg	Cookware, uncovered	1		170-190	180	80-90
Goose legs, 350 g each	Wire rack	2		210-230	-	40-50
Goose legs, 350 g each	Universal pan	1		170-190	180	30-40
Turkey						
Small turkey, 2.5 kg	Cookware, uncovered	1		180-190	-	70-90
Small turkey, 2.5 kg	Cookware, covered	1		210-230	360	45-50
Turkey breast, boned, 1 kg	Cookware, covered	1		240-260	-	80-100
Turkey thigh, with bone, 1 kg	Cookware, uncovered	1		180-200	-	80-100
Turkey thigh, with bone, 1 kg	Cookware, covered	1		210-230	360	45-50

* Preheat for 5 mins

** Observe the information on the packaging

Meat

Your appliance offers you many heating types for preparing meat. You can find the ideal settings for many dishes in the settings tables.

Roasting and braising

Baste lean meat with fat as required or cover it with strips of bacon.

Score the rind crosswise. If you turn the joint when cooking, ensure that the rind is underneath at first.

When the joint is ready, turn off the oven and allow it to rest for another 10 minutes in the cooking compartment. This allows the meat juices to be better distributed. Wrap the joint in aluminium foil if necessary. The recommended standing time is not included in the cooking time specified.

Roasting on the wire rack

On the wire rack, meat will become very crispy on all sides.

Depending on the size and type of the meat, add up to ½ litres of water to the universal pan. Any dripping fat and meat juices will be caught. You can prepare a sauce using these meat juices. In addition, less smoke is generated, and the cooking compartment stays cleaner.

Slide the wire rack in at the indicated shelf position with the imprint "Microwave" facing the appliance door and the outer rail facing downwards. In addition, slide the universal pan in at the shelf position underneath with the slanted edge facing the appliance door.

Roasting and braising in cookware

It is more convenient to roast and braise meat in cookware. You can take the joint out of the cooking compartment more easily in the cookware, and prepare the sauce in the cookware itself.

Only use cookware which is suitable for use in an oven. Check whether the cookware fits in the cooking compartment.

Glass cookware is most suitable. Place hot glass cookware onto a dry mat after cooking. If the surface is damp or cold, the glass may crack.

Add in a little liquid for roasting if the meat is lean. A covering of approx. ½ cm depth should be applied to the base of any glass cookware.

The amount of liquid is dependent on the type of meat, the cookware material and also on whether or not a lid is used. If preparing meat in an enamelled or dark metal roasting dish, it will need a little more liquid than if cooked in glass cookware.

The steam evaporates in the cookware when roasting. Carefully pour in more liquid if required.

Shiny roasting dishes made from stainless steel or aluminium reflect heat like a mirror and are therefore not particularly suitable. The meat cooks more slowly and will not brown so much. Use a higher temperature and/or a longer cooking time.

Observe the manufacturer's instructions for your roasting cookware.

Uncovered cookware

Use a deep roasting tin/dish for roasting meat. Place the tin/dish onto the wire rack. If you do not have any suitable cookware, use the universal pan.

Covered cookware

When cooking with covered cookware, the cooking compartment remains considerably cleaner. Ensure that the lid fits well and closes properly. Place the cookware onto the wire rack.

The distance between the meat and the lid must be at least 3 cm. The meat may rise.

Very hot steam may escape when opening the lid after cooking. Lift the lid at the rear, so that the hot steam can escape away from you.

If necessary, braise the meat first by searing it. Add water, wine, vinegar or a similar liquid to the braising liquid. A covering approx. 1-2 cm deep should be applied to the base of the cookware.

The steam evaporates in the cookware when roasting. Carefully pour in more liquid if required.

Meat can also become crispy in a covered roasting dish. To do so, use a roasting dish with a glass lid and set a higher temperature.

Roasting in combination with a microwave

Certain foodstuffs can be prepared in combination with a microwave. The cooking time is considerably reduced by doing so.

As opposed to conventional operation, the cooking time is based on the total weight when roasting in combination with a microwave.

Tip: If you have quantities other than those indicated in the settings tables, the following basic rule applies: double the quantity equates to roughly double the cooking time.

Always use heat-resistant cookware that is suitable for use in microwaves. Roasting dishes made from metal or Römertopf dishes are only suitable for roasting without using the microwave. Observe the notes on cookware suitable for microwaves. → "Microwave" on page 17

Caution!

If you use an oven bag, do not seal it shut with metal clips. Use kitchen string. Do not use metal skewers for roulades. Sparks may form as a result.

Grilling

Keep the appliance door closed when using the grill. Never grill with the appliance door open.

Slide the wire rack in at the indicated shelf position with the imprint "Microwave" facing the appliance door and the outer rail facing downwards. In addition, slide the universal pan in at least one shelf position lower, with the slanted edge facing the appliance door. Any dripping fat will be caught.

When grilling, try wherever possible to use pieces of food which are of a similar thickness and weight. This will allow them to brown evenly and remain succulent and juicy. Place the food to be grilled directly onto the wire rack.

Use tongs to turn the pieces of food you are grilling. If you pierce the meat with a fork, the juices will run out and it will become dry.

Do not add salt until after the meat has been grilled. Salt draws water from the meat.

Notes

- The grill element switches itself continuously on and off; this is normal. The grill setting determines how frequently this occurs.
- Smoke may be produced when grilling.

Recommended setting values

You can find the ideal heating type for many meat dishes in the table. Temperature and cooking time depend on the amount, composition and temperature of the food. Settings ranges are indicated for this reason. Try using the lower values at first. You can increase the temperature next time if necessary.

The setting values apply to chilled meat placed into the cold cooking compartment. By doing so, you can make energy savings of up to 20 per cent. If you preheat the oven, you can reduce the indicated cooking times by several minutes.

You can find information on roasts and default values for weights in the table. If you wish to roast a heavy joint

of meat, you should definitely use a lower temperature. If roasting several joints, use the weight of the heaviest piece as a basis for determining the cooking time. The individual pieces should be approximately equal in size.





As a general rule: the larger a roasting joint is, the lower the cooking temperature and the longer the cooking time.















Turn roasting joints and grilled items after approx. $\frac{1}{2}$ to $\frac{2}{3}$ of the indicated time.

If you wish to follow one of your own recipes, you should use similar dishes as a reference. You can find additional information in the tips on roasting, braising and grilling attached to the settings table.

Remove unused accessories from the cooking compartment. This will achieve the best possible cooking results and energy savings of up to 20 per cent.

Types of heating used:

-  4D hot air
-  Top/bottom heating
-  Circulated air grilling
-  Grill, large area
-  Microwave















Dish	Accessories/cookware	Shelf position	Type of heating	Temperature in °C/ grill setting	MW power in watts	Cooking time in mins.
Pork						
Joint of pork without rind, e.g. neck, 1.5 kg	Cookware, uncovered	1		180-200	-	120-130
Joint of pork without rind, e.g. neck, 1.5 kg	Cookware, covered	1		180-200	180	40-50
Joint of pork with rind, e.g. shoulder, 2 kg	Cookware, uncovered	1		190-200	-	130-140
Pork tenderloin steak, 1.5 kg	Cookware, uncovered	1		220-230	-	70-80
Pork tenderloin steak, 1.5 kg	Cookware, covered	1		230-240	90	50-60
Fillet of pork, 400 g	Wire rack	2		220-230	-	20-25
Smoked pork on the bone, 1 kg (with a little added water)	Cookware, covered	1		210-220	-	60-80
Smoked pork on the bone, 1 kg	Cookware, uncovered	1		-	360	40-50
Pork steaks, 2 cm thick	Wire rack	3		2	-	16-20
Pork medallions, 3 cm thick (pre-heat oven for 5 mins.)	Wire rack	3		3*	-	8-12
Beef						
Fillet of beef, medium, 1 kg	Cookware, uncovered	1		210-220	-	40-50
Fillet of beef, medium, 1 kg	Cookware, covered	1		180-200	90	30-40
Pot-roasted beef, 1.5 kg	Cookware, covered	1		200-220	-	130-140
Sirloin, medium, 1.5 kg	Cookware, uncovered	1		220-230	-	60-70
Sirloin, medium, 1.5 kg	Cookware, uncovered	1		240-260	180	30-40

* Preheat

** Do not turn

*** Slide the universal pan in underneath at shelf position 1

**** Turn after $\frac{2}{3}$ of the total time

Dish	Accessories/cookware	Shelf position	Type of heating	Temperature in °C/ grill setting	MW power in watts	Cooking time in mins.
Steak, 3 cm thick, medium	Wire rack	2		3	-	15-20
Burger, 3-4 cm thick****	Wire rack	2		3	-	20-30
Veal						
Joint of veal, 1.5 kg	Cookware, uncovered	1		160-170	-	100-120
Joint of veal, 1.5 kg	Cookware, covered	1		200-210	90	70-80
Knuckle of veal, 1.5 kg	Cookware, uncovered	1		200-210	-	100-110
Knuckle of veal, 1.5 kg	Cookware, uncovered	1		200-220	180	30
					90	30-40
Lamb						
Leg of lamb, boned, medium, 1.5 kg	Cookware, uncovered	1		170-190	-	50-70
Leg of lamb, boned, medium, 1.5 kg	Cookware, covered	1		240-260	360	30
					180	35-40
Saddle of lamb on the bone**	Cookware, uncovered	1		180-190	-	40-50
Saddle of lamb on the bone**	Cookware, uncovered	1		190-210	90	30-40
Lamb cutlet***	Wire rack	2		3	-	12-18
Sausages						
Grilled sausages	Wire rack	2		3	-	10-20
Meat dishes						
Meat loaf, 1 kg	Cookware, uncovered	1		170-180	-	70-80
Meat loaf, 1 kg + 50 ml water	Cookware, uncovered	1		170-190	360	30-40
* Preheat						
** Do not turn						
*** Slide the universal pan in underneath at shelf position 1						
**** Turn after 2/3 of the total time						

Tips on roasting and braising

The cooking compartment becomes very dirty.	Prepare your food in an enclosed roaster with higher temperature or use the grill tray. You will achieve the best roasting results if you use the grill tray. The grill tray can be bought later as a special accessory.
The roast is too dark and the crackling is burned in places, and/or the roast is too dry.	Check the shelf position and temperature. Select a lower temperature the next time and reduce the roasting time if necessary.
The crackling is too thin.	Increase the temperature or switch on the grill briefly at the end of the roasting time.
The roast looks good but the juices are burnt.	Next time, use a smaller roasting dish and add more liquid if necessary.
The roast looks good but the juices are too clear and watery.	Next time, use a larger roasting dish and add less liquid if necessary.
The meat gets burned during braising.	The roasting dish and lid must fit together well and close properly. Reduce the temperature and add more liquid when braising if necessary.
The roast is not well-done enough.	Carve the roast. Prepare the sauce in the roasting dish and add the sliced roast meat to the sauce. Finish cooking the meat using the microwave only.

Fish

Your appliance offers you a range of heating types for preparing fish. You can find the ideal settings for many dishes in the settings tables.

The whole fish does not have to be turned. Place the whole fish into the cooking compartment in swimming position with the dorsal fin facing upwards. Placing half a potato or a small oven-proof container in the stomach cavity of the fish will provide stability.

You can tell when the fish is cooked because the dorsal fin can be removed easily.

Roasting and grilling on the wire rack

Slide the wire rack in at the indicated shelf position with the imprint "Microwave" facing the appliance door and the outer rail facing downwards. In addition, slide the universal pan in at least one shelf position lower, with the slanted edge facing the appliance door.

Pour up to ½ litres of water into the universal pan, depending on the size and type of the fish. Any dripping liquid will be caught. Less smoke is generated and the cooking compartment stays cleaner.

Keep the appliance door closed when using the grill. Never grill with the appliance door open.

When grilling, try wherever possible to use pieces of food which are of a similar thickness and weight. This will allow them to brown evenly and remain succulent and juicy. Place the food to be grilled directly onto the wire rack.

Use tongs to turn the pieces of food you are grilling. If you pierce the fish with a fork, the juices will run out and it will become dry.

Notes

- The grill element switches itself continuously on and off; this is normal. The grill setting determines how frequently this occurs.
- Smoke may be produced when grilling.

Roasting and stewing in cookware

Only use cookware which is suitable for use in an oven. Check whether the cookware fits in the cooking compartment.

Glass cookware is most suitable. Place hot glass cookware onto a dry mat after cooking. If the surface is damp or cold, the glass may crack.

Shiny roasting dishes made from stainless steel or aluminium reflect heat like a mirror and are therefore not particularly suitable. The fish cooks more slowly and browns less. Use a higher temperature and/or a longer cooking time.

Observe the manufacturer's instructions for your roasting cookware.

Uncovered cookware

To cook a whole fish, it is best to use a deep roasting tin/dish. Place the tin/dish onto the wire rack. If you do not have any suitable cookware, use the universal pan.

Covered cookware

When cooking with covered cookware, the cooking compartment remains considerably cleaner. Ensure that

the lid fits well and closes properly. Place the cookware onto the wire rack.

When stewing, add two to three tablespoons of liquid and a little lemon juice or vinegar into the cookware.

Very hot steam may escape when opening the lid after cooking. Lift the lid at the rear, so that the hot steam can escape away from you.

Fish can also become crispy in a covered roasting dish. Here, use a roasting dish with a glass lid and set a higher temperature.

Steaming fish in the microwave

You can also steam fish in the microwave.

To do so, use enclosed cookware that is suitable for microwave use or use a plate or microwave film to cover the dish. Observe the notes on cookware suitable for microwaves. → "Microwave" on page 17

This will help retain the flavour and means you can use salt and seasonings sparingly. If cooking fish whole, add one to three tablespoons of water or lemon juice.

After cooking, leave the fish to rest for another 2-3 minutes to compensate for the temperature difference.

Take ready-to-eat meals out of the packaging. You can cook more quickly and evenly using cookware which is suitable for use in microwaves.

Recommended setting values

You can find the ideal heating type for your fish dishes in the table. The temperature and cooking time depend on the amount, composition and temperature of the food. Settings ranges are indicated for this reason. Try using lower setting values first. You can use a higher setting next time if necessary.

The setting values are based on the assumption that chilled fish is placed into a cold cooking compartment. By doing so, you can make energy savings of up to 20 per cent. If you preheat the oven, you can reduce the indicated cooking times by several minutes.

In the table, you can find information for fish with default values for the weight. If you want to cook a heavier fish, you should definitely use the lower temperature. If cooking several fish, you should use the weight of the heaviest fish as a reference for determining the cooking time. The individual fish should be approximately the same size.



As a general rule: the larger a fish, the lower the cooking temperature and the longer the cooking time.



Turn any fish which is not in swimming position after approx. ½ to ⅔ of the indicated time.















Note: Only use greaseproof paper that is suitable for the selected temperature. Always cut greaseproof paper to size.

Remove unused accessories from the cooking compartment. This will achieve the best possible cooking results and energy savings of up to 20 per cent.

Types of heating used:

-  Circulated air grilling
-  Grill, large area

-  Pizza setting
-  coolStart function
-  Microwave

Dish	Accessories/cookware	Shelf position	Type of heating	Temperature in °C/ grill setting	MW power in watts	Cooking time in mins.
Fish						
Fish, grilled, whole 300 g, e.g. trout	Cookware, uncovered	1		170-190	-	20-30
Fish, grilled, whole 300 g, e.g. trout	Wire rack	2		2	90	15-20
Fish, braised, whole 300 g, e.g. trout	Cookware, covered	1		-	600	3
					360	2-7
Fish, grilled, whole 1.5 kg, e.g. salmon	Cookware, uncovered	1		170-190	-	30-40
Fish, braised, whole 1.5 kg, e.g. salmon	Cookware, covered	1		-	600	10
					360	10-15
Fish fillets						
Fish fillet, plain, grilled	Wire rack	2		1*	-	15-25
Fish fillet, plain, braised, 400 g	Cookware, covered	1		-	600	4
					360	5-15
Fish steaks						
Fish steak, 3 cm thick**	Wire rack	2		3	-	18-22
Fish, frozen						
Fish, whole 300 g, e.g. trout	Cookware, covered	1		-	600	5
					360	7-12
Fish fillet, plain	Cookware, covered	1		210-230	-	25-40
Fish fillet, plain, 400 g	Cookware, covered	1		-	600	10-15
Fish fillet, au gratin***	Baking tray	1		-	-	-
Fish fillet, au gratin, 400 g	Cookware, uncovered	1		3	360	15-20
Fish fingers***	Baking tray	1		-	-	-
Fish dishes						
Fish terrine, 1000 g	Terrine mould	1		-	360	20-25
* Preheat						
** Slide the universal pan in underneath at shelf position 1						
*** Observe information on the packaging						

Vegetables and side dishes

Here, you can find information for preparing grilled vegetables, potatoes and frozen potato products.

Remove unused accessories from the cooking compartment. This will allow you to achieve ideal cooking results and save energy.

Preparing food in combination with a microwave

If you wish to cook in combination with a microwave, you should always use enclosed cookware which is suitable for use in microwaves. If you do not have a lid that fits your cookware, use a plate or microwave film for this purpose. Observe the notes on cookware suitable for microwaves.

Food which lies flat will cook more quickly than food which is piled high. Arrange the food as flat as possible in the cookware for this reason.

Cereal products foam a lot during cooking. For all cereal products, such as rice, use tall cookware with a lid.

This will help the food retain its flavour. This means that you can use salt and seasonings sparingly.

If you cannot find any indicated settings for your food quantity, you should extend or reduce the cooking time according to the following basic rule: double the quantity equates to roughly double the cooking time.

Stir or turn the food two to three times during this time. After heating up the food, leave it to rest for two to three minutes to compensate for the temperature difference.

The food transfers heat to the cookware. It can become very hot when only using a microwave for cooking.

Shelf positions

Use the indicated shelf positions.

Cooking on one level

Adhere to the specifications in the table.

Cooking on two levels

Use 4D hot air. Food on different baking trays placed in the oven at the same time will not necessarily be ready at the same time.

- Universal pan: Level 3
- Baking tray: Level 1

Accessories

Ensure that you always use suitable accessories and that they are placed in the oven the right way around.

Wire rack

Slide the wire rack in with the embossed "microwave" facing the appliance door, and the curved lip pointing downwards. Always place ovenware, tins and dishes on the wire rack.

Universal pan or baking tray

Slide the universal pan or the baking tray in carefully as

far as the limit stop with the bevelled edge facing the appliance door.

Greaseproof paper

Only use greaseproof paper that is suitable for the selected temperature. Always cut greaseproof paper to size.





Recommended setting values













In the table, you can find the ideal heating types for various dishes. The temperature and cooking time depend on the amount and composition of the food. Setting ranges are indicated for this reason. Try using the lower values at first. A lower temperature results in more even browning. You can use a higher setting next time if necessary.

The setting values apply to dishes placed into a cold cooking compartment. If you preheat the oven, the indicated cooking times will be reduced by several minutes.

If you wish to follow one of your own recipes when cooking, you can use similar dishes in the table as a reference.

Types of heating used:

-  4D hot air
-  Circulated air grilling
-  Grill, large area
-  coolStart function
-  Microwave

Dish	Accessories/cookware	Shelf position	Type of heating	Temperature in °C/ grill setting	MW power in watts	Cooking time in mins.
Vegetables, fresh						
Vegetables, fresh, 250 g*	Cookware, covered	1		-	600	8-12
Vegetables, fresh, 500 g*	Cookware, covered	1		-	600	12-17
Vegetables, frozen						
Spinach, 450 g*	Cookware, covered	1		-	600	13-18
Mixed vegetables, 250 g + 25 ml water*	Cookware, covered	1		-	600	10-14
Mixed vegetables, 500 g + 25 ml water*	Cookware, covered	1		-	600	15-20
Vegetable dishes						
Grilled vegetables	Universal pan	3		3	-	10-15
Potatoes						
Baked potatoes, halved	Universal pan	1		160-180	-	45-60
Baked potatoes, halved, 1 kg	Universal pan	2		200-220	360	15-20
Unpeeled potatoes, whole, 250 g*	Cookware, covered	1		-	600	10-13
Boiled potatoes, quartered, 500 g*	Cookware, covered	1		-	600	12-15
Potato products, frozen						
Potato rösti**	Universal pan	2		-	-	-
Potato pockets, filled**	Universal pan	1		-	-	-

* Stir once or twice while cooking

** Observe the information on the packaging

Dish	Accessories/cookware	Shelf position	Type of heating	Temperature in °C/ grill setting	MW power in watts	Cooking time in mins.
Croquettes**	Baking tray	1		-	-	-
Chips**	Baking tray	1		-	-	-
Chips, 2 levels (turn during cooking)	Universal pan + baking tray	3+1		200-220	-	30-40
Rice						
Long-grain rice, 250 g + 500 ml water	Cookware, covered	1		-	600	7-9
					180	13-16
Brown rice, 250 g + 650 ml water	Cookware, covered	1		-	600	11-13
					180	25-30
Risotto, 250 g + 900 ml water	Cookware, covered	1		-	600	12-14
					180	22-27
Cereals						
Couscous, 250 g + 500 ml water	Cookware, covered	1		-	600	6-8
Millet, whole, 250 g + 600 ml water	Cookware, covered	1		-	600	8-10
					180	10-15
Polenta/corn semolina, 125 g + 500 ml water*	Cookware, covered	1		-	600	6-8
Pearl barley, 250 g + 750 ml water	Cookware, covered	1		-	600	11-13
					180	15-20
Egg						
Egg custard with 2 eggs	Cookware, covered	1		-	360	6-8
* Stir once or twice while cooking						
** Observe the information on the packaging						

Dessert

You can prepare yogurt and various desserts using your appliance.

When preparing food in a microwave, always use cookware which is heat-resistant and suitable for microwave use. Observe the notes on cookware suitable for microwaves. → "Microwave" on page 17

If you place your cookware onto the wire rack, slide the wire rack in with the imprint "Microwave" facing the appliance door and the outer rail facing downwards.

Preparing yogurt

Remove accessories and shelves from the cooking compartment. The cooking compartment must be empty.

1. Heat 1 litre of milk (3.5 % fat) to 90 °C on the hob and then cool down to 40 °C. It is sufficient to heat UHT milk to 40 °C.
2. Stir in 150 g (chilled) yogurt.
3. Pour into cups or small jars and cover with cling film.
4. Place the cups or jars onto the cooking compartment floor and use the settings indicated in the table.
5. After preparation, leave the yogurt to cool in the refrigerator.

Custard made from custard powder

Mix custard powder with milk and sugar in a tall, microwave-suitable container according to the information on the packaging. Use the settings indicated in the table.

As soon as the milk starts to rise, stir thoroughly. Repeat this step two to three times.

Making rice pudding

1. Weigh the rice and add 4 times as much milk.
2. Pour the rice and milk into a tall container which is suitable for microwave use.
3. Use the settings indicated in the table.
4. As soon as the milk starts to rise, stir thoroughly and reduce the microwave power as indicated in the table. Stir several times whilst it continues to cook.

Compote

Weigh the fruit in a microwave-suitable container and add a tablespoon of water for every 100 g. Add sugar and spices according to taste. Cover the container and use the settings indicated in the table.

Stir two to three times during the cooking time.

Microwave popcorn

Use flat, heat-resistant glass cookware, e.g. the lid of an ovenproof dish. Do not use porcelain or heavily curved plates.

Place the popcorn bag onto the cookware with the labelled side facing downwards. Use the settings indicated in the table. The time may need to be adjusted, depending on the product and quantity in question.



Remove the popcorn bag after 1½ minutes and shake it to ensure that the popcorn doesn't burn. Wipe the cooking compartment clean after preparation.





Warning – Risk of burns!

Airtight packaging may burst when food is heated. Always observe the instructions on the packaging. Always use oven gloves to remove dishes from the cooking compartment.

Recommended setting values

Types of heating used:

-  Top/bottom heating
-  Microwave

Dish	Accessories/cookware	Shelf position	Type of heating	Temperature in °C	MW power in watts	Cooking time in mins.
Custard made from custard powder*	Cookware, covered	1		-	600	5-8
Yogurt	Individual moulds	Cooking compartment floor		40-45	-	8-9h
Rice pudding, 125 g + 500 ml milk*	Cookware, covered	1		-	600	10
					180	20-25
Fruit compote, 500 g	Cookware, covered	1		-	600	9-12
Microwave popcorn, 1 bag 100 g each**	Cookware, uncovered	1		-	600	4-6
* Stir once or twice while cooking						
** Place sealed bag on cookware						

Eco types of heating

Hot air eco and Top/bottom heating eco are intelligent heating types for the gentle preparation of meat, fish and pastries. The appliance optimally controls the supply of energy to the cooking compartment. The food is prepared in phases using residual heat. This means that it remains more succulent and browns less. Energy can be saved, depending on the preparation and food.

Place the food into the empty cooking compartment before it has heated up. Always keep the appliance door closed when cooking.

Remove unused accessories from the cooking compartment. This will allow you to achieve optimum cooking results and save energy.

Only use original accessories supplied with your appliance. These have been tailored to the cooking compartment and the operating modes of your appliance.

Accessories

Ensure that you always use suitable accessories and that they are placed in the oven the right way around.

Wire rack

Slide the wire rack in with the embossed "microwave" facing the appliance door, and the curved lip pointing downwards. Always place ovenware, tins and dishes on the wire rack.

Universal pan or baking tray

Slide the universal pan or the baking tray in carefully as

far as the limit stop with the bevelled edge facing the appliance door.

Baking tins and cookware

Dark- coloured metal baking tins are most suitable. These allow you to make energy savings of up to 35 per cent.

Cookware made from stainless steel or aluminium reflects heat like a mirror. Non-reflective cookware made from enamel, heat-resistant glass or coated, die-cast aluminium is more suitable.

Tinplate baking tins, ceramic dishes or glass dishes prolong baking time, and the cake will not brown so evenly.

Greaseproof paper

Only use greaseproof paper that is suitable for the selected temperature. Always cut greaseproof paper to size.

Recommended setting values



























Here, you can find specifications for various dishes. The temperature and baking time are dependent on the quantity and composition of the dough. Different settings ranges are indicated for this reason. Try using the lower values at first. A lower temperature results in more even browning. If necessary, use a higher setting the next time.

Note: Baking times can not be reduced by using higher temperatures. Cakes or baked items would only be cooked on the outside, but would not be cooked completely in the middle.

Types of heating used:

■  Hotair Eco

■  Top/bottom heating Eco

Dish	Accessories/cookware	Shelf position	Type of heating	Temperature in °C	Cooking time in mins.
Cakes in tins					
Sponge cake in a tin	Ring tin/cake tin	1		140-160	60-80
Sponge flan base	Flan base tin	1		140-160	20-40
Sponge base, 2 eggs	Flan base tin	1		150-170	20-30
Sponge flan, 3 eggs	Springform cake tin, diameter 26 cm	1		160-170	25-35
Sponge flan, 6 eggs	Springform cake tin, diameter 28 cm	1		150-160	50-60
Bundt yeast cake	Bundt cake tin	1		150-160	65-75
Cakes on baking trays					
Sponge cake with dry topping	Baking tray	1		160-180	20-40
Shortcrust tart with dry topping	Baking tray	1		170-180	25-35
Plaited loaf, savarin	Baking tray	1		150-160	35-45
Yeast cake with dry topping	Baking tray	1		150-170	20-35
Small baked items					
Muffins	Muffin tray	2		160-180	15-30
Small cakes	Baking tray	1		150-160	25-35
Puff pastry	Baking tray	2		170-190	25-50
Choux pastry	Baking tray	1		200-220	35-45
Biscuits	Baking tray	2		140-160	15-30
Whirls	Baking tray	2		140-150	25-40
Small yeast cakes	Baking tray	1		150-160	30-40
Bread and bread rolls					
Multigrain bread, 1.5 kg	Cake tin	1		200-210	35-45
Flatbread	Universal pan	1		250-270	15-20
Bread rolls, sweet, fresh	Baking tray	1		170-190	15-20
Bread rolls, fresh	Baking tray	1		180-200	25-35
Meat					
Joint of pork without rind, e.g. neck, 1.5 kg	Cookware, uncovered	1		180-190	120-140
Pot-roasted beef, 1.5 kg	Cookware, covered	1		200-220	140-160
Joint of veal, 1.5 kg	Cookware, uncovered	1		170-180	110-130
Fish					
Fish, braised, whole 300 g, e.g. trout	Cookware, covered	1		190-210	25-35
Fish, braised, whole 1.5 kg, e.g. salmon	Cookware, covered	1		190-210	45-55
Fish fillet, plain, braised	Cookware, covered	1		190-210	15-35

Acrylamide in foodstuffs

Acrylamide is mainly produced in grain and potato products prepared at high temperatures, such as potato

crisps, chips, sliced bread, bread rolls, bread or fine baked goods (biscuits, gingerbread, spiced biscuit).

Tips for keeping acrylamide to a minimum	
General	<ul style="list-style-type: none"> ■ Keep cooking times as short as possible. ■ Cook food until it is golden brown, but not too dark. ■ Large, thick pieces of food contain less acrylamide.
Baking	With top/bottom heating at max. 200 °C. With hot air at max. 180 °C.
Biscuits	With top/bottom heating at max. 190 °C. With hot air at max. 170 °C. Egg or egg yolk reduces the production of acrylamide.
Oven chips	Spread out a single layer evenly on the baking tray. Cook at least 400 g at once on a baking tray so that the chips do not dry out.

Slow cook

Slow cooking is a technique for cooking food over a long period at low temperatures. For this reason, it is also called "low-temperature cooking".

Slow cooking is ideal for all prime cuts (e.g. tender portions of beef, veal, pork, lamb or poultry) which are to be cooked "à point". The meat will remain succulent and tender.

The benefit of this cooking method is that it allows lots of scope for menu planning because slow-cooked meat is easy to keep warm. You do not have to turn the meat when cooking. Keep the appliance door closed in order to maintain an even cooking climate.

Only use fresh, clean and hygienic meat without bones. Carefully remove sinews and fat from around the edge. Fat develops a strong, distinct flavour during slow cooking. You can also use seasoned or marinated meat. Do not use defrosted meat.

Meat can be carved immediately following slow cooking. No standing time is required. Due to the special cooking method, the meat looks pink, but is not raw or undercooked.

Note: Delayed-start operation with an end time is not possible for the slow cooking heating type.

Cookware

Use flat cookware, e.g. a glass/porcelain serving dish. Place the cookware into the cooking compartment to preheat it.

Always place the uncovered cookware onto the wire rack at level 1.

You can find additional information in the tips on slow cooking attached to the settings table.

Your appliance features the heating type "Slow cook". Only start operation when the cooking compartment has fully cooled down. Allow the cooking compartment to warm up for around 10 minutes with the cookware inside.





Sear the meat on the hotplate at a very high heat and for a sufficiently long time on all sides, even on the ends. Place into the preheated cookware right away. Place the cookware containing the meat into the cooking compartment once again and cook slowly.

Recommended setting values

The slow cooking temperature and cooking time are dependent on the size, thickness and quality of the meat. Different settings ranges are indicated for this reason.

Type of heating used:

-  Slow cooking

Dish	Cookware	Shelf position	Type of heating	Searing time in mins.	Temperature in °C	Cooking time in mins.
Poultry						
Duck breast, 400 g	Cookware, uncovered	1		6-8	90*	45-60
Chicken breast fillet, 200 g each	Cookware, uncovered	1		5-7	90*	45-60
Turkey breast, boned, 1 kg	Cookware, uncovered	1		8-10	90*	120-150
Pork						
Pork tenderloin steak, 5-6 cm thick, 1.5 kg	Cookware, uncovered	1		8-10	85*	210-240
Fillet of pork, whole	Cookware, uncovered	1		6-8	85*	60-90
* Preheat						

Dish	Cookware	Shelf position	Type of heating	Searing time in mins.	Temperature in °C	Cooking time in mins.
Pork medallions, 4 cm thick	Cookware, uncovered	1		5-7	85*	90-120
Beef						
Joint of beef (rump), 6-7 cm thick, 1.5 kg	Cookware, uncovered	1		8-10	85*	240-300
Beef tenderloin, whole, 1 kg	Cookware, uncovered	1		4-6	85*	120-180
Sirloin, 5-6 cm thick	Cookware, uncovered	1		6-8	85*	210-270
Beef medallions/rump steak, 4 cm thick	Cookware, uncovered	1		5-7	85*	60-120
Veal						
Joint of veal, 4-5 cm thick, 1.5 kg	Cookware, uncovered	1		8-10	85*	180-240
Joint of veal, 10-15 cm thick, 1.5 kg	Cookware, uncovered	1		8-10	85*	240-300
Veal fillet, whole, 800 g	Cookware, uncovered	1		5-7	85*	150-210
Veal medallions, 4 cm thick	Cookware, uncovered	1		5-7	85*	90-120
Lamb						
Saddle of lamb, boneless, 200 g each	Cookware, uncovered	1		5-7	85*	45-75
Leg of lamb, boned, medium, 1 kg, tied	Cookware, uncovered	1		6-8	85*	180-240
* Preheat						

Tips for slow cooking

Slow-cooking duck breast.	Place the cold duck breast into a pan and fry the skin side first. After slow cooking, grill for 3 to 5 minutes until crispy.
The slow-cooked meat is not as hot as conventionally roasted meat.	So that the roasted meat does not cool so quickly, warm the plates and serve the sauces very hot.

Drying

With 4D hot air, you can dry foods with outstanding results. With this type of preserving, flavourings are concentrated by the dehydration.

Only use unblemished fruit, vegetables and herbs and wash them thoroughly. Line the wire rack with greaseproof paper or parchment paper. Drain the excess water from the fruit and dry it.

If necessary, cut it into equal chunks or thin slices. Place unpeeled fruit onto the dish with the sliced surfaces facing upwards. Ensure that neither fruit nor mushrooms overlap on the wire rack.

Grate vegetables and then blanch them. Allow the blanched vegetables to drain off and distribute them evenly on the wire rack.

Dry herbs on the stem. Position the herbs evenly and slightly heaped on the wire rack.

Use the following shelf positions for drying:

- 1 wire rack: Level 2
- 2 wire racks: Level 3+1

Turn very juicy fruit and vegetables several times. After drying, remove the dried products from the paper immediately.





Recommended setting values

In the table, you can find settings for drying various foodstuffs. The temperature and cooking time are dependent on the type, moisture, ripeness and thickness of the food to be dried. The longer you leave the food to be dried, the better it will be preserved. The thinner the slices are, the quicker the drying process will be and the more aromatic the dried food will remain. Setting ranges are indicated for this reason.

If you wish to dry additional foodstuffs, you should use similar foodstuffs in the table as a reference.

Type of heating used:

-  4D hot air

Dish	Accessories	Shelf position	Type of heating	Temperature in °C	Cooking time in hours
Pomes (apple rings, 3 mm thick, 200 g per wire rack)	Wire rack	2		80	4-7
Stone fruit (plums)	Wire rack	2		80	8-10
Root vegetables (carrots), grated, blanched	Wire rack	2		80	4-7
Sliced mushrooms	Wire rack	2		60	6-8
Herbs, washed	1-2 wire racks	-		60	2-6

Preserving

You can preserve fruit and vegetables using your appliance.

Warning – Risk of injury!

If the food is preserved incorrectly, the preserving jars may burst. Follow the instructions for preserving.

Jars

Use only clean and undamaged preserving jars. Only use heat-resistant, clean and undamaged rubber rings. Check clips and clamps in advance.

For each preserving process, only use preserving jars that are the same size and contain the same food. In the cooking compartment, you can preserve the contents of a maximum of six ½, 1 or 1½-litre preserving jars at the same time. Do not use jars that are larger or taller than this. The lids could rupture.

Preserving jars must not touch one another in the cooking compartment during the preserving process.

Preparing fruit and vegetables

Only use fruit and vegetables that are in good condition. Wash them thoroughly.

Peel, core and chop fruit and vegetables appropriate to their type and fill the preserving jars with them up to approx. 2 cm below the rim.

Fruit

Fill the preserving jars with the fruit along with a hot, skimmed sugar solution (approx. 400 ml for a 1-litre jar). For one litre of water:

- Approx. 250 g sugar for sweet fruit
- Approx. 500 g sugar for sour fruit

Vegetables

Fill the jars with the vegetables along with hot, boiled water.

Wipe the rims of the jars, as they must be clean. Place a damp rubber ring and a lid on each jar. Seal the jars with clamps. Place the jars into the universal pan so that they do not touch each other. Pour 500 ml hot water (approx. 80 °C) into the universal pan. Use the settings indicated in the table.

Ending the preserving process

Fruit

After a short while, small bubbles will form at short intervals. Switch off the appliance once all preserving jars are bubbling. Remove the jars from the cooking compartment after the indicated cooling time.

Vegetables

After a short while, small bubbles will form at short intervals. As soon as all preserving jars are bubbling, reduce the temperature to 120 °C and allow the jars to continue to bubble in the closed cooking compartment as indicated in the table. After this time has elapsed, switch off the appliance and make use of the residual heat for several minutes as indicated in the table.

After preserving, remove the jars from the cooking compartment and place them onto a clean cloth. Do not place these hot jars onto a cold or damp surface, as they may crack. Cover the preserving jars to protect them from draughts. Only remove the clamps once the jars are cold.



Recommended setting values

The indicated times in the settings table are average values for preserving fruit and vegetables. They may be influenced by room temperature, the number of jars, quantity, heat and quality of the jar contents. The specifications are based on 1-litre round jars. Before you switch off the appliance or change the cooking mode, check whether the contents of the jars are bubbling as they should. The bubbling process starts after approx. 30-60 minutes.

Type of heating used:

-  4D hot air

Dish	Cookware	Shelf position	Type of heating	Temperature in °C	Cooking time in mins.
Preserving					
Vegetables, e.g. carrots	1-litre preserving jars	1		160-170	Before it starts bubbling: 30-40
				120	When it starts to bubble: 30-40
				-	Residual heat: 30

Dish	Cookware	Shelf position	Type of heating	Temperature in °C	Cooking time in mins.
Vegetables, e.g. cucumbers	1-litre preserving jars	1		160-170	Before it starts bubbling: 30-40
				-	Residual heat: 30
Stone fruit, e.g. cherries, damsons	1-litre preserving jars	1		160-170	Before it starts bubbling: 30-40
				-	Residual heat: 35
Pomes, e.g. apples, strawberries	1-litre preserving jars	1		160-170	Before it starts bubbling: 30-40
				-	Residual heat: 25

Prove dough

You can prove yeast dough in your appliance more quickly than at room temperature. Use the top/bottom heating type. Only start operation when the cooking compartment has fully cooled down.

Always allow yeast dough to prove twice. Observe the specifications in the settings tables for the 1st and 2nd proving processes (dough fermentation and final fermentation).

Dough fermentation

Use the settings indicated in the table and heat up the appliance. Position the dough bowl on the wire rack.

Do not open the appliance door during the proving process, as moisture will escape. Cover the dough with a damp cloth.

Final fermentation

Place your baked item into the oven at the shelf position indicated in the table.





If you want to preheat the oven, the final fermentation takes place outside the appliance in a warm place.

Recommended setting values

The temperature and proving time are dependent on the type and quantity of the ingredients. The values in the table are therefore only meant to be average values.

Type of heating used:

-  Top/bottom heating

Dish	Accessories/cookware	Shelf position	Type of heating	Temperature in °C	Cooking time in mins.
Yeast dough, light	Bowl	1		35-40	25-30
	Baking tray	1		35-40	10-20
Yeast dough, heavy and rich	Bowl	1		35-40	20-40
	Baking tray	1		35-40	15-25

Defrosting

Use the "Microwave" operation mode to defrost frozen fruit, vegetables, poultry, meat, fish and baked items.

Remove the frozen food from its packaging and place it onto the wire rack in cookware suitable for microwave use. Observe the notes on cookware suitable for microwaves. → "Microwave" on page 17

Slide the wire rack in with the imprint "Microwave" facing the appliance door and the outer rail facing downwards.

Remove unused accessories from the cooking compartment. This will allow you to achieve optimum cooking results and save energy.

Recommended setting values

The times in the table are average values. They are dependent on the quality, freezing temperature (-18 °C) and composition of the food. Time ranges are indicated. Set the shortest time first and then extend the time if necessary. You can often achieve better results when defrosting in several steps. These are indicated one below the other in the table.

Tip: Items which were frozen flat or portioned defrost faster than those frozen in a block.



















Stir the food or turn it once or twice in between. Large pieces of food should be turned several times. Occasionally split the food or remove items which have already defrosted from the cooking compartment.

Leave the defrosted food to rest for another 10 to 30 minutes in the appliance whilst it is switched off, so that the temperature balances out.

Tip: If you have quantities other than those indicated in the settings table, this basic rule will help: double the quantity equates to roughly double the cooking time.

Type of heating used:

■  Microwave

Dish	Accessories/cookware	Shelf position	Type of heating	Temperature in °C	MW power in watts	Cooking time in mins.
Bread, bread rolls						
Bread, 500 g	Cookware, uncovered	1		-	180	3
				-	90	10-15
Bread rolls	Wire rack	1		140-160	90	2-4
Cake						
Cake, moist, 500 g	Cookware, uncovered	1		-	180	2
				-	90	10-15
Cake, dry, 750 g	Cookware, uncovered	1		-	90	10-15
Meat and poultry						
Chicken, whole, 1.2 kg*	Cookware, uncovered	1		-	180	10
				-	90	10-15
Poultry portions, 250 g*	Cookware, uncovered	1		-	180	10
				-	90	10-15
Duck, 2 kg*	Cookware, uncovered	1		-	180	10
				-	90	40-50
Whole pieces of meat, e.g. joint (raw meat), 800 g	Cookware, uncovered	1		-	180	15
				-	90	10-15
Whole pieces of meat, e.g. joint (raw meat), 1 kg*	Cookware, uncovered	1		-	180	15
				-	90	20-30
Whole pieces of meat, e.g. joint (raw meat), 1.5 kg*	Cookware, uncovered	1		-	180	15
				-	90	25-35
Meat, in pieces or slices, e.g. goulash (raw meat), 500 g*	Cookware, uncovered	1		-	180	8
				-	90	5-10
Minced meat, mixed, 200 g*	Cookware, uncovered	1		-	90	8-15
Minced meat, mixed, 500 g*	Cookware, uncovered	1		-	180	5
				-	90	10-15
Minced meat, mixed, 1000 g*	Cookware, uncovered	1		-	180	10
				-	90	20-30
Fish						
Fish, whole, 300 g*	Cookware, uncovered	1		-	180	3
				-	90	10-15
Fish fillet, 400 g*	Cookware, uncovered	1		-	180	5
				-	90	10-15
Fruit, vegetables						
Berries, 300 g	Cookware, uncovered	1		-	180	5-10
Vegetables, 600 g	Cookware, uncovered	1		-	180	10
				-	90	8-13
Miscellaneous						
Defrosting butter, 125 g	Cookware, uncovered	1		-	90	7-9

* Turn halfway through cooking time

Heating food in a microwave

Using the microwave, you can heat food, or defrost and heat it in a single step.

Take ready-to-eat meals out of the packaging. The food will heat up more quickly and evenly in cookware that is suitable for microwaves. The various components of a dish may require different times to heat up.

Food which lies flat will cook more quickly than food which is piled high. Arrange the food as flat as possible in the cookware for this reason. Food should not be vertically stacked.

Cover the food. This will ensure better cooking results. If you do not have a lid that fits your cookware, use a plate or microwave film for this purpose.

Stir food two to three times during cooking and turn it if necessary. After heating food up, leave it to rest for 1 to 2 minutes to compensate for the temperature difference.

If you are heating up baby food, place the bottle onto the wire rack without the teat or the lid. After heating up, shake well or stir and be sure to check the temperature.

The food transfers heat to the cookware. It can become very hot when only using the microwave for preparation.

Tip: If you have quantities other than those indicated in the settings table, this basic rule will help: double the quantity equates to roughly double the cooking time.

Warning – Risk of scalding!

There is a possibility of delayed boiling when a liquid is heated. This means that the liquid reaches boiling temperature without the usual steam bubbles rising to the surface. Even if the container only vibrates a little, the hot liquid may suddenly boil over and spatter. When heating, always place a spoon in the container. This will prevent delayed boiling.

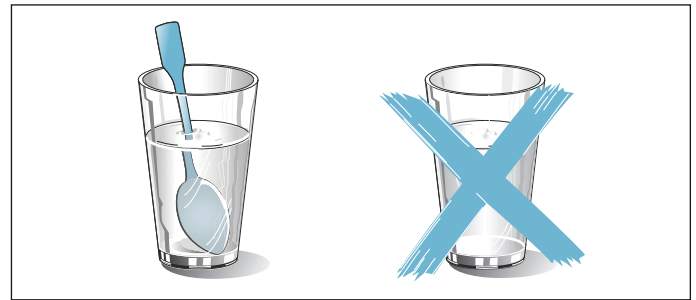

Caution!

Creation of sparks: Metal – e.g. a spoon in a glass – must be kept at least 2 cm from the cooking compartment walls and the inside of the door. Sparks can irreparably damage the glass on the inside of the door.

Recommended setting values

In the table, you can find the setting values for heating various drinks and foodstuffs up in the microwave. The times specified are only average values. These depend on the cookware used, the quality, temperature and composition of the food in question. Time ranges are indicated. Set the shortest time first and then extend the time if necessary.

The values in the table apply to food placed into a cold cooking compartment.









If no values are indicated for your food, use similar foods in the table as orientation.





Remove any accessories from the cooking compartment which are not being used. This will ensure optimum cooking results and will also save energy.

Wipe the cooking compartment clean after cooking.

Type of heating used:

-  Microwave

Dish	Cookware	Shelf position	Type of heating	Temperature in °C	MW power in watts	Cooking time in mins.
Heating drinks						
200 ml (stir well)	Cookware, uncovered	1		-	max	1-3
400 ml (stir well)	Cookware, uncovered	1		-	max	2-6
Heating baby food						
Baby bottles, 150 ml (stir well)	Cookware, uncovered	1		-	360	1-3
Vegetables, chilled						
250 g	Cookware, covered	1		-	600	3-8
Vegetables, frozen						
loose, 250 g	Cookware, covered	1		-	600	8-12
Creamed spinach, frozen block, 450 g	Cookware, covered	1		-	600	11-16
Dishes, chilled						
Plated meal, 1 portion	Cookware, covered	1		-	600	4-8
Soup, stew, 400 ml	Cookware, covered	1		-	600	5-7
Side dishes, e.g. pasta, dumplings, potatoes, rice	Cookware, covered	1		-	600	5-10

Dish	Cookware	Shelf position	Type of heating	Temperature in °C	MW power in watts	Cooking time in mins.
Bakes, 400 g, e.g. lasagne, potato gratin	Cookware, uncovered	1		-	600	5-10
Dishes, frozen						
Plated meal, 1 portion	Cookware, covered	1		-	600	11-15
Soup, stew, 200 ml (stir well)	Cookware, covered	1		-	600	4-6
Side dishes, 500 g, e.g. pasta, dumplings, potatoes, rice	Cookware, covered	1		-	600	7-10
Bakes, 400 g, e.g. lasagne, potato gratin	Cookware, uncovered	1		180-200	180	20-25

Keeping warm

You can keep cooked dishes warm using the "Keeping warm" heating type. This will avoid condensation developing, and means you will not have to wipe out the cooking compartment.

Do not keep cooked dishes warm for longer than two hours. Be aware that some dishes may continue cooking whilst being kept warm. Cover the dishes if necessary.

Test dishes

These tables have been produced for test institutes to facilitate the inspection of the appliance.

As per EN 60350-1:2013 and IEC 60350-1:2011 and as per standard EN 60705:2012, IEC 60705:2010.

Baking

Baked items that are placed into the oven on trays or in baking tins/dishes at the same time will not necessarily be ready at the same time.

Shelf positions for baking on two levels:

- Universal pan: Level 3
- Baking tray: Level 1

Apple pie

Apple pie on one level: place dark-coloured springform cake tins diagonally next to each other.

Cakes in tinplate springform cake tins: bake on one level with top/bottom heating. Place the springform cake tin onto the universal pan instead of onto the wire rack.



Fatless sponge cake

Fatless sponge cake on two levels: vertically stack springform cake tins in an offset manner on the wire racks.

Notes

- The setting values apply to dishes placed into a cold cooking compartment.
- Please note the information in the tables about preheating. The setting values are valid without rapid heating-up.
- For baking, use the lower of the indicated temperatures first.

Types of heating used:

-  4D hot air
-  Top/bottom heating
-  Pizza setting

Dish	Accessories/cookware	Shelf position	Type of heating	Temperature in °C	Cooking time in mins.
Baking					
Shortbread	Baking tray	1		150-160*	20-30
Shortbread	Baking tray	1		140-150*	25-35
Small cakes	Baking tray	1		160*	25-35
Small cakes	Baking tray	1		150*	20-30
Small cakes, 2 levels	Universal pan + baking tray	3+1		140*	30-40
Fatless sponge cake	Springform cake tin, diameter 26 cm	1		160-170**	25-35
Fatless sponge cake	Springform cake tin, diameter 26 cm	1		160-170**	30-45
Apple pie	2 x black plate tins, diameter 20 cm	1		180-200	60-70
Apple pie	2 x black plate tins, diameter 20 cm	1		170-180	60-80

* Preheat for 5 mins, do not use quick heat function

** Preheat, do not use quick heat function



en Tested for you in our cooking studio

Grilling

Also slide in the universal pan. The liquid will be caught and the cooking compartment stays cleaner.

Type of heating used:

-  Grill, large area



Dish	Accessories	Shelf position	Type of heating	Grill setting	Cooking time in mins.
Grilling					
Browning toast	Wire rack	3		3	3-6
Beefburger, 12 pieces*	Wire rack	2		3	20-30
* Turn after 2/3 of the total time					







Preparing food with a microwave

When preparing food in a microwave, always use cookware which is heat-resistant and suitable for microwave use. Observe the notes on cookware suitable for microwaves. → "Microwave" on page 17

If you place your cookware onto the wire rack, slide the wire rack in with the imprint "Microwave" facing the appliance door and the outer rail facing downwards.

Types of heating used:

-  4D hot air
-  Circulated air grilling
-  Microwave

Dish	Accessories/cookware	Shelf position	Type of heating	Temperature in °C	MW power in watts	Cooking time in mins.
Microwave defrosting						
Meat	Cookware, uncovered	1		-	180	5
					90	10-15
Microwave cooking						
Egg wash	Cookware, uncovered	1		-	360	20
					180	20-25
Sponge flan	Cookware, uncovered	1		-	600	7-9
Meat loaf	Cookware, uncovered	1		-	600	22-27
Combined microwave cooking						
Potato gratin	Cookware, uncovered	1		150-170	360	25-30
Cake	Cookware, uncovered	1		190-210	180	12-18
Chicken*	Cookware, uncovered	1		180-200	360	25-35
* Turn after 2/3 of the total time						

BSH Hausgeräte GmbH
Carl-Wery-Str. 34
81739 München, GERMANY

siemens-home.com

Manufactured by BSH Hausgeräte GmbH under Trademark License of Siemens AG



9001221213
960630