

SIEMENS



Hob

ET9..LMP1.

siemens-home.bsh-group.com/welcome

en Instruction manual

Register
your
product
online

ET9..LMP1.

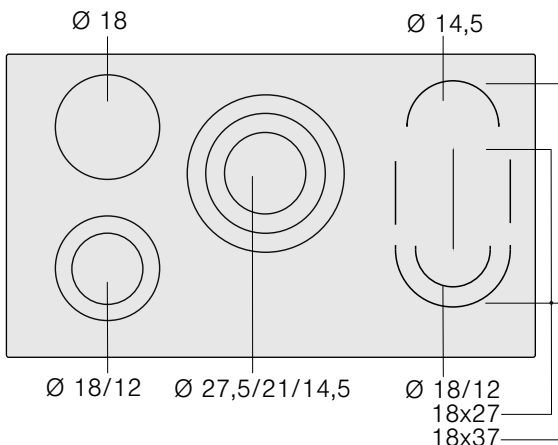

Table of contents

- Intended use** 3
- Important safety information** 3
- Causes of damage** 4
 - Overview 4
- Environmental protection** 4
 - Energy-saving tips 4
 - Environmentally-friendly disposal 4
- Getting to know your appliance** 5
 - The control panel 5
 - The hotplates 5
 - Residual heat indicator 6
- Operating the appliance** 6
 - Switching the hob on and off 6
 - Setting a hotplate 6
 - Table of cooking times 7
- PowerBoost function** 8
 - Switching on PowerBoost 8
 - Switch off PowerBoost 8
- Childproof lock** 8
 - Switching the childproof lock on and off 8
 - Automatic childproof lock 8
- Time-setting options** 8
 - Automatic hotplate switch-off 8
 - Automatic timer 9
 - Kitchen timer 9
 - Stopwatch function 9

- Automatic safety cut-out** 9
- Keep warm function** 9
 - Switching on the Keep warm function 9
 - Switching off the Keep warm function 9
- Wipe protection** 10
- Energy consumption indicator** 10
- Basic settings** 10
 - Changing the basic settings 11
- Cleaning** 11
 - Ceramic 11
 - Hob surround 11
- Trouble shooting** 12
 - E-report in the displays 12
- Customer service** 12
 - E number and FD number 12
- Test dishes** 13

Additional information on products, accessories, replacement parts and services can be found at **www.siemens-home.bsh-group.com** and in the online shop **www.siemens-home.bsh-group.com/eshops**

Intended use

Read these instructions carefully. Please keep the instruction and installation manual, as well as the appliance certificate, in a safe place for later use or for subsequent owners.

Check the appliance for damage after unpacking it. Do not connect the appliance if it has been damaged in transport.

Only a licensed professional may connect appliances without plugs. Damage caused by incorrect connection is not covered under warranty.

This appliance is intended for private domestic use and the household environment only. The appliance must only be used for the preparation of food and beverages. The cooking process must be supervised. A short cooking process must be supervised without interruption. Only use the appliance in enclosed spaces.

This appliance is intended for use up to a maximum height of 2000 metres above sea level.

This appliance may be used by children over the age of 8 years old and by persons with reduced physical, sensory or mental capabilities or by persons with a lack of experience or knowledge if they are supervised or are instructed by a person responsible for their safety how to use the appliance safely and have understood the associated hazards.

Children must not play with, on, or around the appliance. Children must not clean the appliance or carry out general maintenance unless they are at least 15 years old and are being supervised.

Keep children below the age of 8 years old at a safe distance from the appliance and power cable.

Important safety information

Warning – Risk of fire!

- Hot oil and fat can ignite very quickly. Never leave hot fat or oil unattended. Never use water to put out burning oil or fat. Switch off the hotplate. Extinguish flames carefully using a lid, fire blanket or something similar.
- The hotplates become very hot. Never place combustible items on the hob. Never place objects on the hob.
- The appliance gets hot. Do not keep combustible objects or aerosol cans in drawers directly underneath the hob.
- The hob switches off automatically and can no longer be operated. It may switch on unintentionally at a later point. Switch off the circuit breaker in the fuse box. Contact the after-sales service.
- Do not use hob covers here. They can cause accidents, for example due to overheating, catching fire or materials shattering.

Warning – Risk of burns!

- The hotplates and surrounding area (particularly the hob surround, if fitted) become very hot. Never touch the hot surfaces. Keep children at a safe distance.
- The hotplate heats up but the display does not work. Switch off the circuit breaker in the fuse box. Contact the after-sales service.
- It is only allowed to use safety devices, e.g. hob guards, which have been approved by ourselves. Unsuitable safety devices or hob guards may result in accidents.

Warning – Risk of electric shock!

- Incorrect repairs are dangerous. Repairs may only be carried out and damaged power cables replaced by one of our trained after-sales technicians. If the appliance is defective, unplug the appliance from the mains or switch off the circuit breaker in the fuse box. Contact the after-sales service.
- Do not use any high-pressure cleaners or steam cleaners, which can result in an electric shock.

- A defective appliance may cause electric shock. Never switch on a defective appliance. Unplug the appliance from the mains or switch off the circuit breaker in the fuse box. Contact the after-sales service.
- Cracks or fractures in the glass ceramic may cause electric shocks. Switch off the circuit breaker in the fuse box. Contact the after-sales service.

⚠ Warning – Risk of injury!

Saucepans may suddenly jump due to liquid between the pan base and the hotplate. Always keep the hotplate and saucepan bases dry.

Causes of damage

Caution!

- Rough pot and pan bases scratch the ceramic.
- Avoid boiling pots dry. This may cause damage.
- Never place hot pots or pans on the control panel, the display area or the surround. This may cause damage.
- Damage can occur if hard or pointed objects fall on the hob.
- Aluminium foil and plastic containers melt on hot hotplates. Oven protective foil is not suitable for your hob.

Overview

You will find the most frequently caused damage in the following table.

Damage	Cause	Measure
Stains	Boiled over food	Remove boiled over food immediately with a glass scraper.
	Unsuitable cleaning agents	Only use cleaning agents that are suitable for glass ceramic.
Scratches	Salt, sugar and sand	Do not use the hob as a work surface or storage space.
	Rough pot and pan bases scratch the ceramic.	Check your cookware.
Discolouration	Unsuitable cleaning agents	Only use cleaning agents that are suitable for glass ceramic.
	Pan abrasion (e.g. aluminium)	Lift pots and pans when moving them.
Blisters	Sugar, food with a high sugar content	Remove boiled over food immediately with a glass scraper.

Environmental protection

In this section, you can find information about saving energy and disposing of the appliance.

Energy-saving tips

- Always place suitable lids on saucepans. When cooking without a lid, considerably more energy is required. A glass lid means that you can see inside without having to lift the lid.
- Use pots and pans with even bases. Uneven bases increase energy consumption.
- The diameter of pot and pan bases should be the same size as the hotplate. In particular, small saucepans on the hotplate cause energy losses. Please note: cookware manufacturers often indicate the upper diameter of the saucepan. This is usually bigger than the diameter of the base of the pan.
- Use a small saucepan for small quantities. A larger, less full saucepan requires a lot of energy.
- Cook with only a little water. This will save energy. Vitamins and minerals in vegetables are preserved.
- Always cover as large an area of the hotplate as possible with your saucepan.
- Switch to a lower heat setting in good time.
- Select a suitable ongoing cooking setting. You will waste energy by using an ongoing cooking setting which is too high.
- Use the residual heat of the hob. For longer cooking times, you can switch the hotplate off 5-10 minutes before the end of the cooking time.

Environmentally-friendly disposal

Dispose of packaging in an environmentally-friendly manner.



This appliance is labelled in accordance with European Directive 2012/19/EU concerning used electrical and electronic appliances (waste electrical and electronic equipment - WEEE). The guideline determines the framework for the return and recycling of used appliances as applicable throughout the EU.

Getting to know your appliance

The instruction manual is the same for various different hobs. You can find the hob dimensions in the overview of models. → Page 2

The control panel

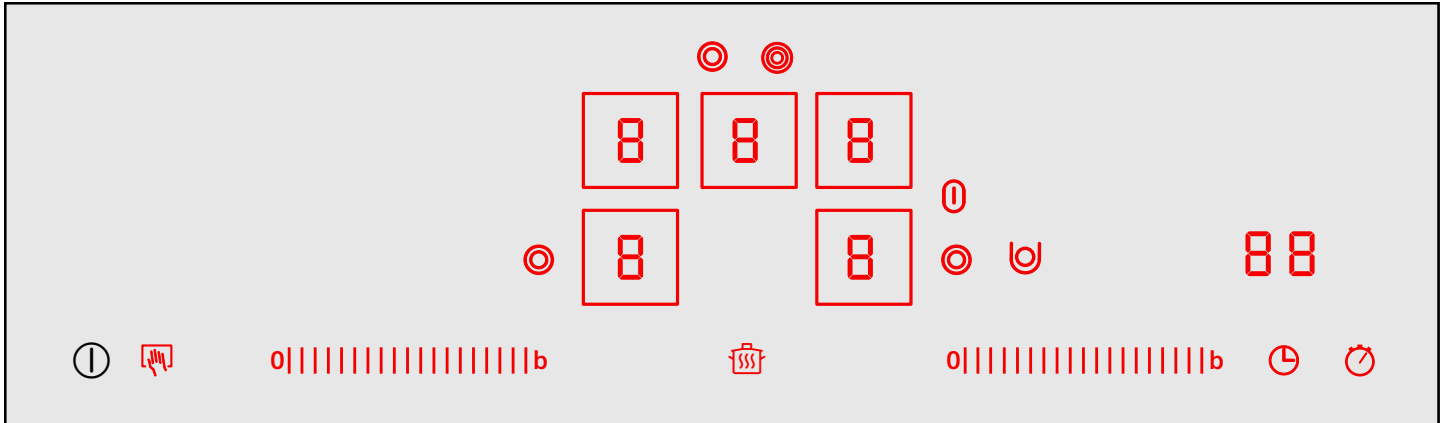

Display

1-9	Heat settings
H/h	Residual heat
b	PowerBoost function
L	Keep warm function
88	Timer

Controls

ⓘ	Main switch
b	PowerBoost function
B	Hotplate selection
🚫	Childproof lock
🧽	Wipe protection
0 1 2 3 4 5 6 7 8 9	Control panel*
⊙	Activating the dual-circuit hotplate
⊙	Activating the tri-circuit hotplate
⊙	Activating the small cooking zone
⊙	Activating the extended cooking zone
🍵	Keep-warm function
🕒	Timer
🕒	Stopwatch function

*The middle hotplate is adjusted on the right-hand control panel

Notes

- Depending on the operating condition of the hob the controls which can currently be selected light up brightly or dimmed. If you touch them, the relevant function is activated.
- The controls which cannot currently be selected do not light up.

- The settings of the hotplates currently selected light up brightly.
- Always keep the controls dry. Moisture reduces their effectiveness.
- Do not pull pans close to the displays and sensors. The electronics could overheat.

The hotplates

Hotplate	Activating and deactivating	
⊙	Single-circuit hot-plate	
⊙	Dual-circuit hotplate	Touch the ⊙ symbol
⊙	Tri-circuit hotplate	Touch the ⊙ symbol; the 2nd filament circuit is activated Touch the ⊙ symbol; the 2nd and 3rd filament circuit are activated
When the hotplate is activated: the corresponding indicator lights up		

Notes

- Any dark areas in the glow pattern of the hotplate are due to technical reasons. The function of the hotplate is not affected.
- Hotplate temperature is regulated by the heat switching on and off. The heat may also switch on and off at the highest setting. This ensures e.g.:
 - sensitive components are protected from overheating
 - the appliance is protected from electrical overload
 - better cooking results are achieved
- With multi-circuit hotplates the heater elements of the inner filament circuits and the heater element of the activations may switch on and off at different times.

Combination cooking zone

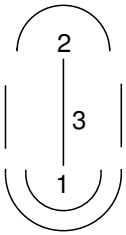

- 1 = dual-circuit hotplate
- 2 = single-circuit hotplate
- 3 = bridge heating element

The single and dual-circuit hotplate can be operated without the bridge heating element independently of each other or combined with the bridge heating element as described in the table.

Combination	Activation	Suitable for
Small roasting zone:	With the symbol activate the bridge heating element.	Small roaster Small teppan yaki
Combination of 1 + 3	symbol lights up brightly.	
Large roasting zone:	Touch the symbol	Large roaster Large teppan yaki
Combination of 1 + 3 + 2	symbol lights up brightly.	Large grill plate

The small roasting zone (1 + 3) and the single-circuit hotplate (2) can also be operated independently of each other with different heat settings. Different temperature ranges are therefore generated at the large roaster, the teppan yaki or the grill plate, for example: the small roasting zone can then be used to fry a meal and the single-circuit hotplate can simultaneously be used to keep a meal warm.

Note: Suitable cookware is available from the after-sales service or our e-Shop.

Residual heat indicator

The hob has a two-stage residual heat indicator for each hotplate.

If **H** appears in the display the hob is still hot. It may be used, for example, to keep a small meal warm or to melt cooking chocolate. As the hotplate cools down further, the display changes to **h**. The display remains lit until the hotplate has cooled sufficiently.

Operating the appliance

In this section, you can find out how to set the hotplates. The table shows heat settings and cooking times for various meals.

Switching the hob on and off

The main switch is used to switch the hob on and off.

Switching on the appliance

Touch the symbol. A signal sounds. The indicator light above the main switch lights up. The control displays and the heat setting displays light up. The hob is ready for use.

The two front hotplates are automatically selected. The heat setting displays light up brightly.

Switching off the appliance

Touch the symbol until the indicator light above the main switch and the displays go out. All hotplates are switched off. The residual heat indicator remains on until the hotplates have cooled down sufficiently.

Notes

- The hob will switch itself off automatically once all hotplates have been switched off for a while (10-60 seconds).
- The settings remain stored for 4 seconds after the hob has been switched off. If you switch it on again during this time, the hob will operate using the previously stored settings.

Setting a hotplate

Select the desired heat setting on the control panel.

Heat setting 1 = Lowest power

Heat setting 9 = Highest power

Every heat setting has an intermediate setting. It appears on the display, e.g. as **4.5**.

Selecting the heat setting

The hob must be on.

1. Touch the heat setting display to select the hotplate.
 lights up brightly on the heat setting display
2. Select the required heat setting on the control panel.

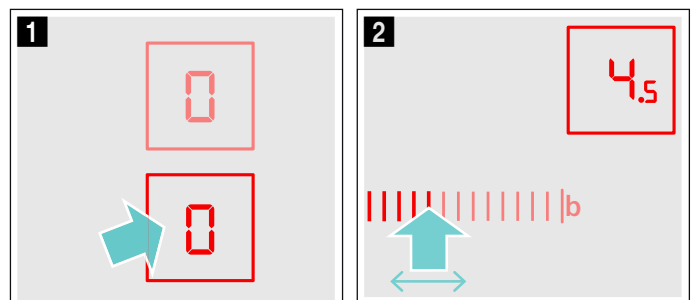

The hotplate is switched on.

Changing the heat setting:

Select the hotplate and set the required heat setting on the control panel.

Switching off the hotplate

Select the hotplate. Set the control panel to 0. After about 10 seconds, the residual heat indicator appears.

Note: The last selected hotplate remains activated. You can set the hotplate without selecting it again.

Table of cooking times

The following table provides some examples.

Cooking times and heat settings may vary depending on the type of food, its weight and quality. Deviations are therefore possible.

For bringing liquids to the boil, use heat setting 9.

Stir thick liquids occasionally.

Food that needs to be seared quickly or food which loses a lot of liquid during initial frying is best seared in several small portions.

Tips for energy-saving cooking can be found in the Environmental protection section. → Page 4

	Ongoing cooking setting	Ongoing cooking time in minutes
Melting		
Chocolate coating	1-1.5	-
Butter, honey, gelatine	1-2	-
Heating and keeping warm		
Stew (e.g. lentil stew)	1-2	-
Milk**	1.5-2.5	-
Heating sausages in water**	3-4	-
Defrosting and heating		
Frozen spinach	2.5-3.5	10-20 min
Frozen goulash	2.5-3.5	20-30 min
Poaching, simmering		
Dumplings	4.5-5.5*	20-30 min
Fish	4-5*	10-15 min
White sauces, e.g. béchamel sauce	1-2	3-6 min
Whisked sauces, e.g. sauce Béarnaise, hollandaise	3-4	8-12 min
Boiling, steaming, braising		
Rice (with double the quantity of water)	2-3	15-30 min
Rice pudding	1.5-2.5	35-45 min
Unpeeled boiled potatoes	4-5	25-30 min
Boiled potatoes	4-5	15-25 min
Pasta, noodles	6-7*	6-10 min
Stew, soups	3.5-4.5	15-60 min
Vegetables	2.5-3.5	10-20 min
Frozen vegetables	3.5-4.5	10-20 min
Cooking in a pressure cooker	4-5	-
Braising		
Roulades	4-5	50-60 min
* Ongoing cooking without a lid		
** Without lid		
*** Turn frequently		

	Ongoing cooking setting	Ongoing cooking time in minutes
Pot roast	4-5	60-100 min
Goulash	2.5-3.5	50-60 min
Frying with little oil**		
Escalope, plain or breaded	6-7	6-10 min
Escalope, frozen	6-7	8-12 min
Chop, plain or breaded***	6-7	8-12 min
Steak (3 cm thick)	7-8	8-12 min
Hamburger, rissoles (3 cm thick)***	4.5-5.5	30-40 min
Poultry breast (2 cm thick)***	5-6	10-20 min
Poultry breast, frozen***	5-6	10-30 min
Fish and fish fillet, plain	5-6	8-20 min
Fish and fish fillet, breaded	6-7	8-20 min
Fish and fish fillet, breaded and frozen, e.g. fish fingers	6-7	8-12 min
Scampi and prawns	7-8	4-10 min
Sautéing vegetables, fresh mushrooms	7-8	10-20 min
Vegetables, meat in Asian-style strips	7.5-8.5	15-20 min
Stir fry, frozen	6-7	6-10 min
Pancakes	6-7	consecutively
Omelette	3.5-4.5	consecutively
Fried eggs	5-6	3-6 min
Deep-fat frying (150-200 g per portion continuously in 1-2 litres oil**)		
Frozen products, e.g. chips, chicken nuggets	8-9	-
Croquettes, frozen	7-8	-
Meat, e.g. chicken portions	6-7	-
Fish, breaded or battered	5-6	-
Vegetables, mushrooms, breaded or battered, tempura	5-6	-
Small baked items, e.g. ring doughnuts/jam-filled doughnuts, fruit in batter	4-5	-
* Ongoing cooking without a lid		
** Without lid		
*** Turn frequently		

PowerBoost function

PowerBoost lets you heat up large volumes of water even faster than on heat setting 9.

PowerBoost is only available on hotplates marked with the **boost** symbol.

With dual-circuit hotplates the second filament circuit has to be activated for use with the PowerBoost function.

Switching on PowerBoost

1. Select the hotplate.
2. Touch the **b** symbol. The **b** display lights up. The PowerBoost function is switched on.

Switch off PowerBoost

1. Select the cooking zone.
2. Select any ongoing cooking setting. The **b** display goes out. PowerBoost is switched off.

Notes



- If you do not turn off the PowerBoost function, it switches off automatically after a certain period of time. The hotplate switches back to the heat setting 9.
- Please remember that oil and fat heat up quickly with PowerBoost. Never leave the hob unattended. Oil and fat that have overheated will catch fire quickly, see section "Important safety information". → Page 3

Childproof lock

You can use the childproof lock to prevent children from switching on the hob.

Switching the childproof lock on and off

The hob must be switched off.

To switch on: Switch on the hob using the main switch ①. Touch the  symbol for 4 seconds. The  display lights up for 10 seconds. The hob is locked.

To switch off: Switch on the hob using the main switch ①. Touch the  symbol for 4 seconds. The lock is released.

Automatic childproof lock

This function automatically activates the childproof lock every time you switch the hob off.

Switching on and off

Find out how to switch the automatic childproof lock on and off in the Basic settings section. → Page 10

Time-setting options

There are 3 different time-setting options:



- A hotplate should switch off automatically
- Kitchen timer
- Stopwatch

Automatic hotplate switch-off

Enter a cooking time for the relevant hotplate. When the cooking time has elapsed, the hotplate switches off automatically.

Setting the cooking time

The hotplate must be switched on.

1. Touch the symbol  2 and then select the hotplate. The  display lights up. **00 min** lights up in the timer display.



2. Touch the desired presetting in the settings range. The possible presetting from left to right is 1, 2, 3, etc. to 9 minutes. Within 10 seconds, slide your finger along the settings range repeatedly until the desired cooking time is reached.

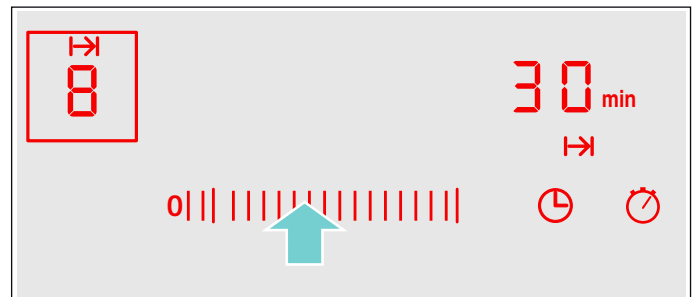

The cooking time counts down. If you have set a cooking time for more than one hotplate, the shortest cooking time is always displayed.

Automatic setting

If you touch settings range presets 1 to 5 for a longer time, the cooking time automatically counts back down to one minute.

If you touch settings range presets 6 to 9 for a longer time, the cooking time automatically counts up to 99 minutes.

When the time has elapsed,

When the cooking time has elapsed, the hotplate switches off. You will hear an audible signal and **00** lights up in the display for 10 seconds. The indicator **l→** flashes. Touch any symbol. The displays go out and the audible signal ceases.

Changing or cancelling the cooking time

Touch the symbol **⊖ 2** and then select the hotplate. Change the cooking time or set to **00** in the settings range.

Notes

- You can set a cooking time of up to 99 minutes.
- If the cooking time has counted down to the last minute, the timer display changes from minutes to seconds.

Automatic timer

You can use this function to preselect a cooking time for all hotplates. Each time a hotplate is switched on, the pre-selected cooking time then counts down. When the cooking time has elapsed, the hotplate switches off automatically.

You can find out how to switch on the automatic timer in the Basic settings section. → *Page 10*

Note: You can change the cooking time for a hotplate or switch off the automatic timer for the hotplates: Touch the symbol **⊖ 2** and then select the hotplate. Change the cooking time or set to **00** in the settings range.

Kitchen timer

You can use the kitchen timer to set a time of up to 99 minutes. It runs independently of all the other settings. To activate it the hob must be on.

Setting the kitchen timer

1. Touch the **⊖** symbol, the **⏰** display lights up. **00 min** lights up in the timer display.
2. Set the desired time in the settings range. The timer starts counting down after a few seconds.

When the time has elapsed,

When the time has elapsed, you will hear an audible signal and **00** lights up in the display for 10 seconds. The indicator **⏰** flashes. Touch any symbol. The displays go out and the audible signal ceases.

Setting the correct time

Use the **⊖** symbol to select the kitchen timer and reset the time.

Stopwatch function

The stopwatch function displays the time that has passed since activating the function.

The stopwatch function only works when the hob is switched on. When the hob is switched off, the stopwatch function is switched off as well.

The stopwatch function is switched on by touching the **⌚** symbol. **00** appears in the timer display and timing starts. Seconds are displayed during the first minute, and then minutes.

The stopwatch function is switched off by touching the **⌚** symbol again. The timer display goes out.

Note: If another time-setting option is selected in addition to the stopwatch function, the setting appears in the timer display for 10 seconds. The stopwatch function is then displayed again.



Automatic safety cut-out

If a hotplate has been switched on for a long time without the setting being changed, the automatic time limit is activated.

The hotplate stops heating. **FB** and the **H/h** residual heat indicator flash alternately on the hotplate display.

The display goes out when you touch any control. You can make new settings.

When the time limit is activated depends on the heat setting selected (1 to 10 hours).



Keep warm function

The Keep warm function is suitable for melting chocolate or butter and for warming food and cookware

Switching on the Keep warm function



1. Touch the **☰** symbol
2. Select the hotplate. **L** lights up on the heat setting display. The Keep warm function is switched on.

Switching off the Keep warm function

1. Touch the **☰** symbol.
2. Select the hotplate. **L** lights up on the heat setting display. The Keep warm function is switched off.

Wipe protection

If you wipe over the control panel while the hob is switched on, settings may be altered.

To prevent this from happening, your hob has a wipe protection function. Touch the  symbol. An audible signal sounds. The  symbol lights up. The control panel is locked for 30 seconds. You can now wipe over the control panel without altering any settings.

Note: The main switch is excluded from the wipe protection function. You can switch off the hob at any time.

Energy consumption indicator

You can use this function to have the total energy consumption between switching the hob on and off displayed.

Once switched off, the consumption in kilowatt hours (e.g. 1.87 kWh) is displayed for 10 seconds

The accuracy of the display depends, amongst other things, on the voltage quality of the power supply.



The display has not been activated. You can find out how to activate the display in the Basic settings section. → Page 10

Basic settings

Your appliance has various basic settings. You can adapt these settings to suit your own needs.

Display screen	Function
c 1	Automatic childproof lock
0	Switched off.*
1	Switched on.
2	Manual and automatic childproof lock switched off.
c 2	Audible signal
0	Confirmation signal and operation error signal are switched off (main switch signal always remains).
1	Only the operation error signal is switched on.
2	Only the confirmation signal is switched on.
3	Confirmation signal and operation error signal switched on.*
c 3	Energy consumption display (Ask your electricity supply company what the mains voltage is)
0	Consumption display switched off.*
1	Consumption display with mains voltage at 230 V.
2	Consumption display with mains voltage at 400 V.
3	Consumption display with mains voltage at 220 V.
4	Consumption display with mains voltage at 240 V.
c 5	Automatic timer
00	Switched off.*
0 1-99	Cooking time, after which the hotplates switch off.
c 6	Duration of the timer end signal
1	10 seconds.*
2	30 seconds
3	1 minute.
c 7	Activation of the heating elements
0	Switched off.
1	Switched on.
2	Last setting before the hotplate was switched off.*
c 0	Reset the basic settings
0	Switched off.*
1	Switched on.

*Basic setting

Changing the basic settings

The hob must be switched off.

1. Switch on the hob.
2. Within the next 10 seconds, touch the ⌚ symbol for 4 seconds.

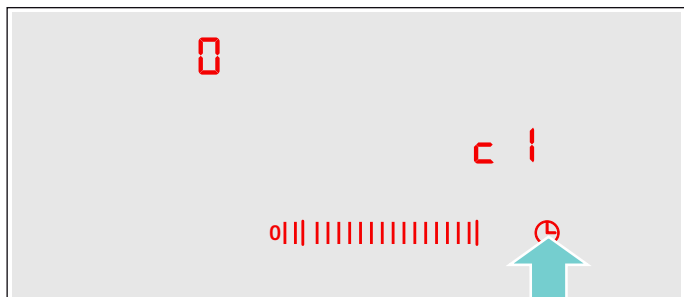

1 appears and 0 lights up in the hotplate display.

3. Touch the ⌚ symbol repeatedly until the desired display appears.
4. Set the desired value on the control panel.

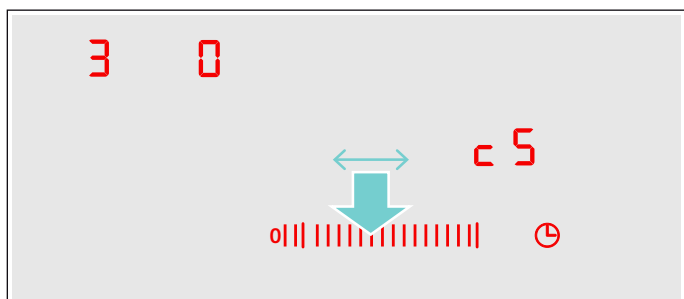

5. Touch the ⌚ symbol for 4 seconds. The setting is activated.

Switching off

To exit the basic setting, switch off the hob with the main switch and make new settings.

Cleaning

Suitable maintenance and cleaning products can be purchased from the after-sales service or in our e-Shop.

Ceramic

Clean the hob after each use. This will prevent spills from burning onto the ceramic.

Only clean the hob when it has cooled down sufficiently.

Use only cleaning agents which are suitable for glass ceramic. Follow the cleaning instructions on the packaging.

Never use:

- Undiluted washing-up liquid
- Detergent intended for dishwashers
- Scouring agents
- Harsh cleaning agents such as oven spray or stain remover
- Abrasive sponges
- High-pressure cleaners or steam jet cleaners

Ground-in dirt can be best removed with a glass scraper, available from retailers. Please note the manufacturer's instructions.

You can also obtain a suitable glass scraper from our after-sales service or from the e-Shop.

Using special sponges to clean glass ceramic achieves great cleaning results.

Hob surround

To prevent damage to the hob surround, observe the following instructions:

- Use only hot soapy water.
- Wash new sponge cloths thoroughly before use.
- Do not use any sharp or abrasive agents.
- Do not use the glass scraper.

Trouble shooting

Faults often have simple explanations. Please read the notes in the table before calling the after-sales service.

The electronics of your hob are underneath the control panel. For various reasons, the temperature in this area may rise sharply.

In order that the electronics do not overheat, the hotplates are switched off as and when necessary. The **F2**, **F4**, or **F5** display appears alternately with the **H** or **h** residual heat indicator.

Display	Fault	Measure
None	The power supply has been disconnected.	Check the household fuse for the appliance. Check whether there is a power cut by trying other electronic appliances.
All displays flash	The touch control is wet or an object is resting on it.	Dry the control or remove the object.
F2	Several hotplates have been used over a prolonged period at high power settings. To protect the electronics, the hotplate has been switched off.	Wait a while. Touch any touch control. When F2 goes out, the electronics have cooled down sufficiently. You can continue cooking.
F4	Despite the switch-off by F2 , the electronics have become hot again. All hotplates have therefore been switched off.	Wait a while. Touch any touch control. When F4 goes out, you can continue cooking.
F5 and the heat setting flash alternately. An audible signal can be heard	Warning: There is a hot pan in the area of the control panel. There is a risk that the electronics will overheat.	Remove the pan. The fault display goes out shortly afterwards. You can continue cooking.
F5 and audible signal	There is a hot pan in the area of the control panel. To protect the electronics, the hotplate has been switched off.	Remove the pan. Wait a while. Touch any control. When F5 goes out, you can continue cooking.
F8	The hotplate was in operation for too long and has switched itself off.	You can switch the hotplate back on again immediately.
dE The hotplates do not heat up	Demo mode is switched on	Switching off the demo mode: Disconnect the appliance for 30 seconds from the power supply (switch off the household fuse or the circuit breaker in the fuse box). Touch any touch control after 3 minutes. The demo mode is switched off.

E-report in the displays

When an error message with "E" appears in the display, e.g. E0111, switch the appliance off and on again.

If it was a one-off error, the display goes out. If the error message appears again, call the after-sales service and quote the exact error message.

Customer service

Our after-sales service is there for you if your appliance needs to be repaired. We will always find an appropriate solution, also in order to avoid after-sales personnel having to make unnecessary visits.

E number and FD number

Please quote the E-number (product number) and the FD number (production number) of your appliance when contacting the after-sales service. The rating plate bearing these numbers can be found on the appliance certificate.

Please note that a visit from an after-sales service engineer is not free of charge in the event of misuse of the appliance, even during the warranty period.

Please find the contact data of all countries in the enclosed customer service list.

To book an engineer visit and product advice

GB 0344 892 8999

Calls charged at local or mobile rate.

IE 01450 2655

0.03 € per minute at peak. Off peak 0.0088 € per minute.

Rely on the professionalism of the manufacturer. You can therefore be sure that the repair is carried out by trained service technicians who carry original spare parts for your appliances.

Test dishes

This table has been produced for test institutes to facilitate the testing of our appliances.

The data in the table refers to our accessory cookware from Schulte Ufer (4-part induction pot set HZ 390042) with the following dimensions:

- Saucepan dia. 16 cm, 1.2 litres, for 14.5 cm dia. single-circuit hotplate

- Cooking pot dia. 16 cm, 1.7 litres, for 14.5 cm dia. single-circuit hotplate
- Cooking pot dia. 22 cm, 4.2 litres, for 18 cm dia. or 17 cm dia. hotplate
- Frying pan dia. 24 cm, for 18 cm dia. or 17 cm dia. hotplate

Test dishes	Heating up/bringing to boil		Ongoing cooking		
	Heat setting	Cooking time (min:sec)	Lid	Ongoing cooking setting	Lid
Melting chocolate					
Cookware: saucepan					
Chocolate couverture (e.g. Dr. Oetker dark chocolate, 150 g) on 14.5 cm dia. hotplate	-	-	-	1.	No
Heating and keeping lentil stew warm					
Cookware: cooking pot					
<i>Lentil stew made to DIN 44550</i>					
Initial temperature 20° C					
Amount: 450 g for 14.5 cm dia. hotplate	9	approx. 2:00 without stirring	Yes	1.	Yes
Amount: 800 g for 18 cm dia. or 17 cm dia. hotplate	9	approx. 2:00 without stirring	Yes	1.	Yes
<i>Lentil stew from the tin</i>					
e.g lentils with Erasco sausages:					
Initial temperature 20° C					
Amount 500 g for 14.5 cm dia. hotplate	9	approx. 2:00 (Stir after approx. 1:30)	Yes	1.	Yes
Amount: 1000 g for 18 cm dia. or 17 cm dia. hotplate	9	approx. 2:30 (Stir after approx. 1:30)	Yes	1.	Yes
Simmering Béchamel sauce					
Cookware: saucepan					
Milk temperature: 7° C					
Recipe: 40 g butter, 40 g flour, 0.5 l milk (3.5% fat content) and one pinch of salt for 14.5 cm dia. hotplate	g ²	approx. 5:20	No	1 ^{1,3}	No
				¹ Melt the butter, stir in the flour and salt, and keep cooking the roux for 3 minutes	
				² Add the milk to the roux and bring to the boil, stirring continuously	
				³ After the Béchamel sauce has come to the boil, keep cooking it at setting 1 for a further 2 minutes, stirring all the time	

Test dishes	Heating up/bringing to boil		Ongoing cooking		
	Heat setting	Cooking time (min:sec)	Lid	Ongoing cooking setting	Lid
Cooking rice pudding - Ongoing cooking with lid					
Cookware: cooking pot					
Milk temperature: 7° C					
Recipe: 190 g round grain rice, 90 g sugar, 750 ml milk (3.5% fat content) and 1 g salt for 14.5 cm dia. hotplate	9	approx. 6:45 Heat the milk until it starts to rise up. Switch down to the ongoing cooking setting and add the rice, sugar and salt to the milk Total cooking time (incl. bringing to boil) approx. 45 minutes	No	2	Yes
Stir the rice pudding after 10 minutes					
Recipe: 250 g round grain rice, 120 g sugar, 1 l milk (3.5% fat content) and 1.5 g salt for 18 cm dia. or 17 cm dia. hotplate	9	approx. 7:20 Heat the milk until it starts to rise up. Switch down to the ongoing cooking setting and add the rice, sugar and salt to the milk Total cooking time (incl. bringing to boil) approx. 45 minutes	No	2	Yes
Stir the rice pudding after 10 minutes					
Cooking rice pudding - Ongoing cooking without lid					
Cookware: cooking pot					
Milk temperature: 7° C					
Recipe: 190 g round grain rice, 90 g sugar, 750 ml milk (3.5% fat content) and 1 g salt for 14.5 cm dia. hotplate	9	approx. 7:30 Add rice, sugar and salt to the milk and heat the mixture up, stirring continuously. At a milk temperature of approx. 90°C switch down to the ongoing cooking setting. Simmer for approx. 50 minutes	No	2	No
Recipe: 250 g round grain rice, 120 g sugar, 1 l milk (3.5% fat content) and 1.5 g salt for 18 cm dia. or 17 cm dia. hotplate	9	approx. 8:00 Add rice, sugar and salt to the milk and heat the mixture up, stirring continuously. At a milk temperature of approx. 90°C switch down to the ongoing cooking setting. Simmer for approx. 50 minutes	No	2	No
Cooking rice					
Cookware: cooking pot					
Water temperature 20° C					
Recipe acc. to DIN 44550:					
125 g long grain rice, 300 g water and a pinch of salt for 14.5 cm dia. hotplate	9	approx. 2:48	Yes	2	Yes
Recipe acc. to DIN 44550:					
250 g long grain rice, 600 g water and a pinch of salt for 18 cm dia. or 17 cm dia. hotplate	9	approx. 3:15	Yes	2.	Yes

Test dishes	Heating up/bringing to boil		Ongoing cooking		
	Heat setting	Cooking time (min:sec)	Lid	Ongoing cooking setting	Lid
Frying pork loin chops					
Cookware: frying pan					
Initial temperature loin chops: 7° C					
Amount: 3 loin chops (total weight approx. 300 g, about 1 cm thick) 15 g sunflower oil for 18 cm dia. or 17 cm dia. hotplate	9	approx. 2:40	No	7	No
Frying pancakes					
Cookware: frying pan					
Recipe acc. to DIN EN 60350-2					
Amount: 55 ml batter per pancake for 18 cm dia. or 17 cm dia. hotplate	9	approx. 2:40	No	6 or 6. depending on browning level	No
Deep-fat frying frozen chips					
Cookware: cooking pot					
Amount: 1.8 kg sunflower oil, per portion: 200 g frozen chips (e.g. McCain 123 Original fries) for 18 cm dia. or 17 cm dia. hotplate	9	Until oil temperature reaches 180 °C	No	9	No

If the tests are carried out with an 18 cm dia. hotplate with a power rating of 1500 W, the boiling time is increased by approx. 20% and the ongoing cooking setting by one ongoing cooking setting.

BSH Hausgeräte GmbH
Carl-Wery-Str. 34, 81739 München
GERMANY

siemens-home.bsh-group.com

Manufactured by BSH Hausgeräte GmbH under Trademark License of Siemens AG



9001154288
971018