



SIEMENS



Washing machine

WM14W750GB

siemens-home.com/welcome

en Instruction Manual and Installation Instructions

Register
your
product
online

Your new washing machine

You have chosen a Siemens washing machine.

Please take a few minutes to read and become familiar with the advantages of your washing machine.

To meet the high quality demands required by Siemens, every washing machine that leaves our factory is carefully checked to ensure that it functions correctly and is in perfect condition.

For more information on our products, accessories, replacement parts and services, see our website www.siemens-home.com or contact our after-sales service centres.

If the operating and installation instructions describe different models, any differences will be pointed out at the relevant points in the text.



Read these operating and installation instructions before switching on the washing machine.

Display rules

Warning!

This combination of symbol and signal word indicates a possibly dangerous situation. Not heeding the warning can cause death or injuries.

Caution!

This signal word indicates a possibly dangerous situation. Not heeding the caution can cause property and/or environmental damage.

Note/tip

Information about the optimum use of the appliance/any other useful information.















1. 2. 3. / a) b) c)









The steps are represented by numbers or letters.

■ / -

Lists are represented by a small box or a dash.

Contents

	Intended use	5		Laundry	28
	Safety instructions	6		Prepare the laundry	28
	Children/people/pets	6		Sorting laundry	28
	Installation	7		Detergent	29
	Operation	10		Correct selection of detergent	29
	Cleaning/Maintenance	11		Saving energy and detergent	29
	Environmental protection	13		Overview of programmes	30
	Packaging/used appliance	13		Programmes on the programme	
	Tips on economical use	13		selector	30
	Positioning and connecting	14		sensoFresh 	35
	Included with the appliance	14		Starching	35
	Safety instructions	15		Dyeing/bleaching	35
	Installation surface	15		Soaking	35
	Installation on a base or			Programme default settings	36
	a wooden joist floor	15		Temperature	36
	Installation on a platform			Spin speed	36
	with drawer	15		Finish in	36
	Installing the appliance in			Additional programme	
	a kitchenette	16		settings	37
	Removing the transport locks	16		speedPerfect 	37
	Hose and cable lengths	17		ecoPerfect 	37
	Water inlet	18		Prewash	37
	Water outlet	19		Extra Rinse	37
	Levelling	20		Less Ironing	37
	Electrical connection	20		sensoFresh Intensity	37
	Before using the appliance for				
	the first time	21			
	Transportation	22			
	Main points in brief	23			
	Getting to know the				
	appliance	24			
	Washing machine	24			
	Control panel	25			
	Display panel	26			

	Operating the appliance.	38
	Preparing the washing machine . . .	38
	Switching on the appliance/ selecting a programme	38
	Placing laundry into the drum	38
	Measure and add detergent and care products	39
	Change the programme default settings	40
	Select additional programme settings	40
	Start the programme	40
	Child lock	41
	Adding laundry	41
	Changing the programme	41
	Cancel the programme	42
	Programme end during rinse hold. .	42
	Programme end.	42
	Removing laundry/switching off the appliance.	42
	Appliance settings	43
	Activating the setting mode	43
	Changing the signal volume	43
	Selecting/deselecting the appliance automatic switch-off.	43
	Switching the drum-care information signal on/off	43
	Exiting setting mode	43
	Sensors	44
	Automatic load sensing.	44
	Unbalanced load detection system .	44
	AquaSensor.	44
	Cleaning and maintenance . . .	44
	Machine housing/control panel. . . .	45
	Drum	45
	Descaling.	45
	Detergent drawer and housing	45
	The drain pump is blocked, emergency draining.	46
	The drain hose at the siphon is blocked	47
	Filter in the water supply blocked . .	47
	Faults and what to do about them.	48
	Emergency release.	48
	Information on the display panel . . .	49
	Faults and what to do about them. . .	50
	After-sales service	52
	Consumption rates.	53
	Energy and water consumption, programme duration and residual moisture for the main washing programmes.	53
	Efficiency test programmes for cotton fabrics	54
	Technical data.	54
	Aqua-Stop warranty	55



Intended use

- This appliance is intended for private domestic use only.
- Do not install or operate this appliance anywhere that is liable to experience frost and/or outdoor conditions. There is a risk that the appliance will be damaged if residual water in it freezes. If hoses freeze up, they may crack/burst.
- This appliance must only be used for washing domestic laundry, consisting of machine-washable items and hand-washable woollens (see label on item). Using the appliance for any other purpose is outside of the scope of its intended application and is forbidden.
- This appliance is suitable for operation with cold mains water and commercially available detergents and care products (must be suitable for use in washing machines).
- This appliance is intended for use up to a maximum height of 4000 metres above sea level.

Before you switch on the appliance:

Check that there is no visible damage to the appliance. Do not operate the appliance if it is damaged. Should you have any problems, please contact your specialist dealer or our customer service.

Read and follow the operating and installation instructions and all other information provided with this appliance.

Retain the documents for subsequent use or for subsequent owners.

Safety instructions

The following safety information and warnings are provided to protect you from injury and to prevent material damage to your surroundings.

It is nevertheless important to take the necessary precautions and to proceed with care when installing, maintaining, cleaning and operating the appliance.

Children/people/pets

Warning **Risk of death!**

Children and other people who are unable to assess the risks involved when using the appliance may injure themselves or may find themselves in life-threatening situations. Therefore please note:

- The appliance may be used by children over the age of 8 years and by persons with reduced physical, sensory or mental capacity or by persons with a lack of experience or knowledge as long as they are supervised or have received instruction on how to use the appliance safely and they have understood the potential risks of using the appliance.
- Children must not play with this appliance.

- Do not allow children to clean or maintain this appliance unsupervised.
- Keep children under 3 years and pets away from this appliance.
- Do not leave the appliance unattended when children or other people who are unable to assess the risks are in the vicinity.

Warning **Risk of death!**

Children may lock themselves inside appliances and find themselves in a life-threatening situation.

- Do not position the appliance behind a door, as this may obstruct the appliance door or prevent it from opening completely.
- Once an appliance has reached the end of its life, pull the mains plug from the socket **before** severing the mains cable, and then destroy the lock on the appliance door.

⚠ Warning**Risk of suffocation!**

If allowed to play with the packaging/plastic film or packing components, children may become caught in these or pull them over their heads and suffocate.

Keep packaging, plastic film and packing components away from children.

⚠ Warning**Risk of poisoning!**

Detergents and care products may result in poisoning if consumed.

If accidentally swallowed, seek medical advice. Keep detergents and care products out of the reach of children.

⚠ Warning**Risk of burns!**

When washing at high temperatures, the glass in the appliance door becomes hot. Stop children from touching the appliance door when it is hot.

⚠ Warning**Eye/skin irritation!**

Contact with detergents or care products may cause eye/skin irritation.

Rinse eyes/skin thoroughly if they/it come(s) into contact with detergents or care products. Keep detergents and care products out of the reach of children.

Installation**⚠ Warning****Risk of electric shock/fire/material damage/damage to the appliance!**

If the appliance is not installed properly, this may lead to a dangerous situation. Make sure that:

- The mains voltage on your power socket matches the rated voltage specified on the appliance (identification plate). The connected loads and the required fuse protection are specified on the identification plate.
- The appliance is only connected to a source of alternating current via a nationally recognized and grounded outlet that has been correctly installed.
- The mains plug and the grounded socket match and the earthing system has been correctly installed.
- The cross section of the cable is sufficiently large enough.
- The mains plug is accessible at all times.
- If using a residual current circuit breaker, only use one that bears the following mark: . The presence of this mark is the only way to be sure that it fulfils all the applicable regulations.

⚠ Warning

**Risk of electric shock/fire/
material damage/damage to
the appliance!**

If the appliance's mains cable is altered or damaged, this may result in electric shock, short circuiting or fire due to overheating.

The mains cable must not be kinked, crushed or altered, and must not come into contact with any heat sources.

⚠ Warning

**Risk of fire/material damage/
damage to the appliance!**

The use of extension cords or power strips may result in fire due to overheating or short circuiting.

Connect the appliance directly to an earthed socket that has been correctly installed. Do not use extension cords, power strips or multi-way couplers.

⚠ Warning

**Risk of injury/material
damage/damage to the
appliance!**

- The appliance may vibrate or move when in operation, potentially resulting in injury or material damage.
Place the appliance on a clean, even, solid surface and, using a spirit level to guide you, level it with the screw-in feet.

- If you take hold of any of the appliance's protruding parts (e.g. the appliance door) in order to lift or move it, these parts may break off and cause injury.

Do not take hold of any of the appliance's protruding parts in order to move the appliance.

⚠ Warning

Risk of injury!

- The appliance is very heavy. Lifting it may result in injury. Do not lift the appliance on your own.
- The appliance has sharp edges on which you could cut your hands. Do not take hold of the appliance by its sharp edges. Wear protective gloves to lift it.
- If the hoses and mains cables are not correctly routed, they may constitute a tripping hazard, which may result in injury. Route hoses and cables such that they do not constitute a tripping hazard.

Caution!**Material damage/damage to the appliance**

- If the water pressure is too high or too low, the appliance may not be able to operate properly, and it may also result in material damage or damage to the appliance.
Make sure that the water pressure in the water supply facility is at least 100 kPa (1 bar), and does not exceed 1000 kPa (10 bar).
- If the water hoses are altered or damaged, this may result in material damage or damage to the appliance. The water hoses must not be kinked, crushed, altered or severed.
- The use of hoses supplied by other brands to connect to the water supply may result in material damage or damage to the appliance. Use the hoses supplied with the appliance or genuine spare part hoses only.
- The appliance is secured for transportation by transport locking devices. If the transport locking devices are not removed before the appliance is operated, this may result in damage to the appliance.
It is important to completely remove all transport locking devices before using the appliance for the first time. Make sure that you retain these transport locking devices separately. It is important to refit the transport locking devices if the appliance is to be transported, in order to prevent the appliance from being damaged in transit.

Operation

Warning

Risk of explosions/fire!

Laundry that has been pretreated with cleaning agents that contain solvents, e.g. stain remover/cleaning solvent, may cause an explosion in the drum. Rinse the laundry thoroughly with water before washing it in the machine.

Warning

Risk of poisoning!

Poisonous fumes may be given off by cleaning agents that contain solvents, e.g. cleaning solvent.

Do not use cleaning agents that contain solvents.

Warning

Risk of injury!

- If you support your weight/sit on the appliance door when it is open, the appliance may tip over, which may result in injury.

Do not support your weight on the appliance door when it is open.

- If you climb onto the appliance, the worktop may break, which may result in injury.

Do not climb onto the appliance.

- If you reach into the drum while it is still rotating, you risk injuring your hands. Wait until the drum has stopped rotating.

Warning

Risk of scalding!

When washing at high temperatures, there is a risk of scalding if you come into contact with hot detergent solution (e.g. when draining hot detergent solution into a washbasin).

Do not reach into the hot detergent solution.

Warning

Irritation of the respiratory tract/eyes!

This appliance runs programmes that use active oxygen. Active oxygen can irritate the mucosa and cause eyes to water.

Do not open the door using the emergency release if a programme is running with active oxygen. Wait until the door has been released.

⚠ Warning**Eye/skin irritation!**

Detergent and care products may spray out if the detergent drawer is opened while the appliance is in operation. Rinse eyes/skin thoroughly if they/it come(s) into contact with detergents or care products. If accidentally swallowed, seek medical advice.

Caution!**Material damage/damage to the appliance**

- If the amount of laundry in the appliance exceeds its maximum load capacity, it may not be able to operate properly, or this may result in material damage or damage to the appliance.
Do not exceed the maximum load capacity of dry laundry. Make sure you comply with the maximum load capacities specified for each of the programs. → *Page 30*
- If you pour the wrong quantity of detergent or cleaning agent into the appliance, this may result in material damage or damage to the appliance.
Use detergents/care products/cleaning agents and softeners in accordance with the manufacturers' instructions.

Cleaning/Maintenance**⚠ Warning****Danger of death!**

The appliance is powered by electricity. There is a risk of electric shock if you come into contact with live components. Therefore please note:

- Switch off the appliance. Disconnect the appliance from the power supply (pull out the plug).
- Never take hold of the mains plug with wet hands.
- When removing the mains plug from the socket, always take hold of the plug itself and never the mains cable, otherwise this may damage the mains cable.
- Do not make any technical modifications to the appliance or its features.
- Repairs and any other work on the appliance must only be conducted by our customer service or by an electrician. The same applies for replacing the mains cable (when necessary).
- Spare mains cables can be ordered from our customer service.

 Warning

Risk of poisoning!

Poisonous fumes may be given off by cleaning agents that contain solvents, e.g. cleaning solvent.

Do not use cleaning agents that contain solvents.

 Warning

Risk of electric shock/material damage/damage to the appliance!

If moisture penetrates the appliance, this may cause it to short circuit.

Do not use a pressure washer or steam cleaner to clean your appliance.

 Warning

Risk of injury/material damage/damage to the appliance!

The use of spare parts and accessories supplied by other brands is dangerous and may result in injury, material damage or damage to the appliance.

For safety reasons, use genuine spare parts and accessories only.

Caution!

Material damage/damage to the appliance

Cleaning agents and agents for pretreating laundry (e.g. stain removers, prewash sprays, etc.) may cause damage if they come into contact with the surfaces of the appliance. Therefore please note:

- Do not allow these agents to come into contact with the surfaces of the appliance.
- Clean the appliance with nothing but water and a soft, damp cloth.
- Remove any detergent, spray or other residues immediately.



Environmental protection

Packaging/used appliance



Dispose of packaging in an environmentally-responsible manner.

This appliance is labelled in accordance with European Directive 2012/19/EU concerning used electrical and electronic appliances (waste electrical and electronic equipment - WEEE).

The guideline determines the framework for the return and recycling of used appliances as applicable throughout the EU.

Tips on economical use

- Always fill the appliance with the maximum amount of laundry for the relevant programme.
Overview of programmes
→ *Page 30*
- Wash normally soiled laundry without a prewash.
- Save energy and detergent when washing lightly and normally soiled laundry. → *Page 29*
- The selectable temperatures apply to the care labels on the textiles. The temperatures in the machine may deviate from this so that you get the optimum mix of energy-saving and washing results.
- **Information on energy and water consumption:** → *Page 26*
The displays provide information about the relative level of energy and water consumption in the selected programmes.
The more indicator lights light up, the higher the programme's consumption.
This enables you to compare the consumption levels of the different programmes when choosing your programme settings and decide on an energy- and water-saving programme setting.
- **Energy-saving mode:** The display panel lighting goes out after a few minutes and the ►|| button flashes. Press any button to activate the lighting.
Energy-saving mode is not activated if a programme is running.
- **Automatic switch off:** If the appliance is not operated for a prolonged period, it may automatically switch off before the programme starts and when the programme has ended to save energy. Press the main switch again to switch on the appliance. Switching the → *Page 43* function on/off
- If the laundry is subsequently dried in a tumble dryer, select the spin speed according to the tumble dryer manufacturer's instructions.



Positioning and connecting

Included with the appliance

Note: Check the machine for transport damage. Never use a damaged machine. If you have any complaints, contact the dealer from whom you purchased the appliance or our customer services. → Page 52

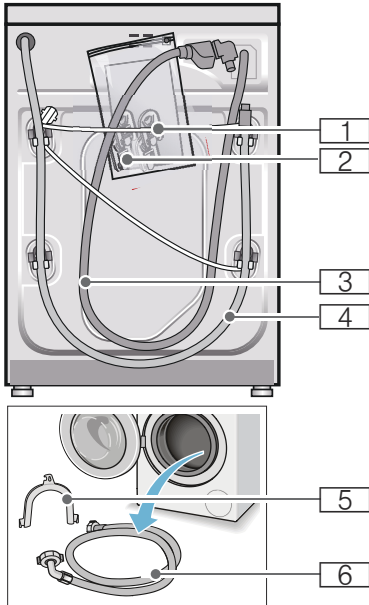

- 1 Mains cable
 - 2 Bag:
 - Installation and operating instructions
 - Customer services location directory*
 - Warranty*
 - Cover caps for openings after the transport braces have been removed
 - Adaptor with sealing washer from 21 mm = 1/2" to 26.4 mm = 3/4" *
 - 3 Water supply hose on Aqua-Stop models
 - 4 Water drain hose
 - 5 Elbow for securing the water drain hose*
 - 6 Water supply hose on standard/ Aqua-Secure models
- * depending on the model

In addition, a hose clamp (24 - 40 mm diameter, available from specialist dealers) is required to connect the water drain hose to a siphon.

Useful tools

- Spirit level for aligning
- Spanner with:
 - WAF13 for loosening the transport braces, and
 - WAF17 for aligning the appliance feet

Safety instructions

Warning

Risk of injury!

- The washing machine is very heavy. Be careful when lifting/transporting the washing machine.
- When the washing machine is lifted by its protruding parts (e.g. the washing machine door), the components may break off and cause injuries. Do not lift the washing machine by protruding parts.
- If the hose and mains cables are not routed properly, there is a risk of tripping and injury. Lay hoses and cables in such a way that there is no risk of tripping.

Caution!

Damage to the appliance

Frozen hoses may rip/burst. Do not install the washing machine in areas exposed to frost or outdoors.

Caution!

Water damage

The connection points for the water supply hose and water drain hose are under high water pressure. To prevent leaks and water damage, you must follow the instructions in this section.

Notes

- In addition to the safety information listed here, the local water and electricity supplier may have special requirements.
- If in doubt, have the appliance connected by a specialist.

Installation surface

Note: The washing machine be stable so that it does not move around.

- The installation surface must be firm and level.
- Soft floors/floor coverings are not suitable.

Installation on a base or a wooden joist floor

Caution!

Damage to the appliance

The washing machine may "wander" and tip/topple from the base when spinning.

The feet of the appliance must be secured with holding brackets. Order no. WMZ 2200, WX 9756, Z 7080X0

Note: On wooden joist floors, install the washing machine:

- In a corner, if possible,
- On a water-resistant wooden board (min. 30 mm thick) which is screwed tightly to the floor.

Installation on a platform with drawer

Platform order no.: WMZ 20490, WZ 20490, WZ 20510, WZ 20520

Installing the appliance in a kitchenette

Warning **Danger of death!**

There is a risk of electric shock if you touch live components.
Do not remove the appliance covering plate.

Notes

- Recess width of 60 cm required.
- Only install the washing machine underneath a continuous worktop that is securely connected to adjacent cabinets.

Removing the transport locks

Caution! **Damage to the appliance**

- The machine is secured for transportation using transport locks. If the transport locks are not removed, the drum, for example, may become damaged when the machine is operated. Before using the appliance for the first time, make sure that you completely remove all four transport locks. Keep the locks in a safe place.
- To prevent transport damage from occurring if the appliance is moved at a later date, you must refit the transport locks before transporting the appliance.

Note: Keep the screws and sleeves in a safe place.

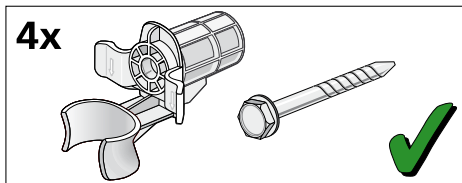

1. Take the hoses out of the holders.

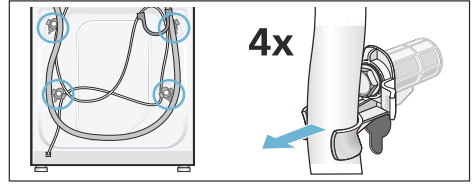

2. Unscrew and remove all four transportation securing bolts with a wrench (WAF 13). Remove the sleeves. Remove the mains cable from the holders.

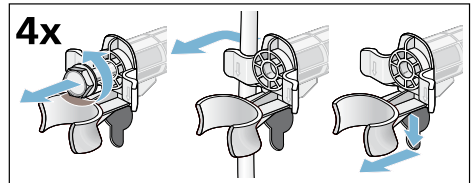

3. Insert the covers. Lock the covers firmly in place by applying pressure to the snap-in hooks.

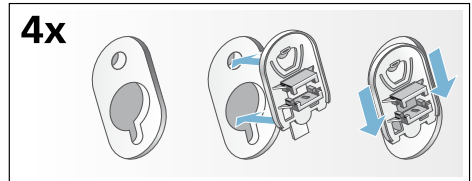

Hose and cable lengths

■ Left-hand connection

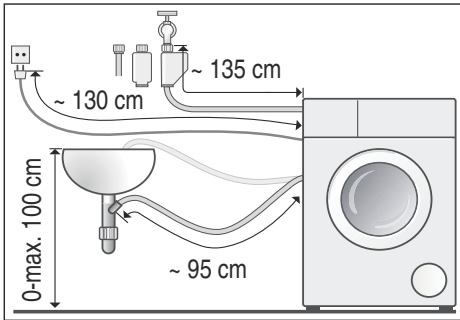

■ Right-hand connection

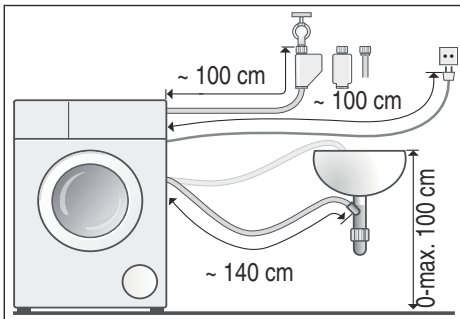

Tip: The following are available from specialist dealers/customer services:

- Extension for Aqua-Stop and cold water supply hose (approx. 2.50 m); order no. WM Z2380, WZ 10130, CZ 11350, Z 7070X0
- A longer supply hose (approx. 2.20 m) for standard models; individual component number for customer services: 00353925

Water inlet

Warning **Danger of death!**

There is a risk of electric shock if you touch live components.
Do not immerse the Aqua-Stop safety valve in water (it contains an electric valve).

Notes

- Only operate the washing machine using cold mains water.
 - Do not connect the machine to the mixer tap of an unpressurised hot-water boiler.
 - Do not use a used supply hose. Only use the supply hose supplied or one that was purchased from an authorised specialist retailer.
 - Do not kink or squash the water supply hose.
 - Do not alter (shorten, cut through) the water supply hose (otherwise its strength is no longer guaranteed).
 - Only tighten the screw connections by hand. If the screw connections are tightened too much with a tool (pliers), the thread may become damaged.
 - When connecting to a 21 mm = 1/2" tap, first fit an adapter* with a sealing washer from 21 mm = 1/2" to 26.4 mm = 3/4".
- *supplied depending on the model

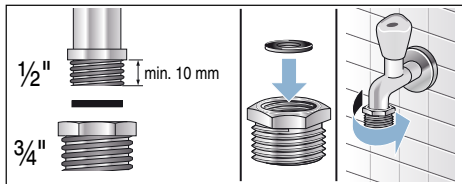

Optimum water pressure in the supply network

At least 100 kPa (1 bar)

Maximum 1000 kPa (10 bar)

When the tap is open, the water flow rate is at least 8 l/min.

If the water pressure is higher than this, a pressure-reducing valve must be installed.

Connection

Connect the water supply hose to the tap (26.4 mm = 3/4") and to the appliance (not necessary for Aqua-Stop models as this is permanently installed):

- Model: **Standard**

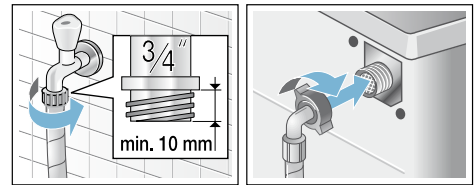

- Model: **Aqua-Secure**

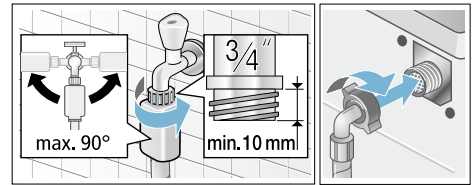

- Model: **Aqua-Stop**

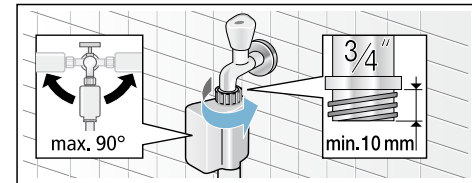

Note: Turn on the tap carefully, checking the leak tightness of the connection points. The screw connection is under mains water pressure.

Water outlet

Warning

Risk of scalding!

When you are washing at high temperatures, there is a risk of scalding if you come into contact with hot water (e.g. when draining hot water into a washbasin).

Do not reach into the hot water.

Caution!

Water damage

If the drain hose slips out of the washbasin or the connection point during draining due to high water pressure, any escaping water may cause water damage.

Secure the drain hose so that it cannot slip out.

Caution!

Damage to the appliance/fabrics

If the end of the drain hose is immersed in the drained water, water may be sucked back into the appliance and may damage the appliance/fabrics.

Make sure that:

- The plug does not block drainage from the washbasin.
- The end of the drain hose is not immersed in the drained water.
- The water drains away quickly enough.

Note: Do not kink the water drain hose or put strain on it lengthways.

Connection

■ Drainage into a washbasin

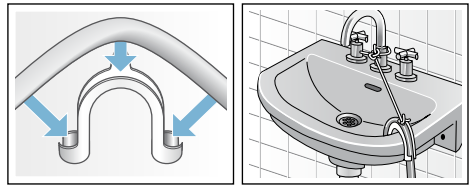

■ Drainage into a siphon

The connection point must be secured using a hose clamp with a diameter of 24 - 40 mm (available from specialist dealers).

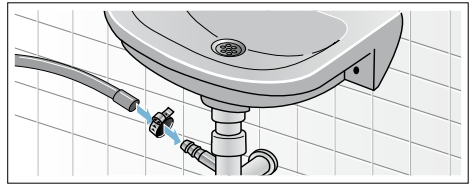

■ Drainage into a plastic pipe with rubber bushing or into a drainage pit

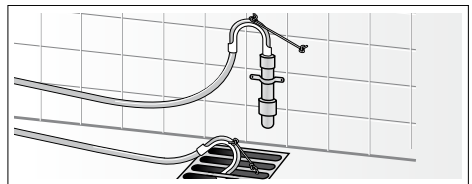

Levelling

Align the appliance using a spirit level.

Incorrect alignment may result in loud noises, vibrations and machine "movement".

1. Loosen the lock nuts using a WAF17 spanner, by turning it in a clockwise direction.
2. Check the alignment of the washing machine with a spirit level, and adjust it if necessary. Change the height by turning the appliance feet. All four appliance feet must stand firmly on the ground.
3. The lock nuts on all four appliance feet must be screwed tightly against the housing using a suitable WAF17 spanner. In doing so, hold the foot tight and do not adjust its height.

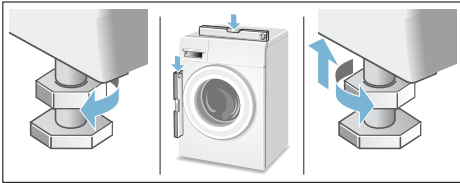

Electrical connection

Warning **Danger of death!**

There is a risk of electric shock if you touch live components.

- Never touch or hold the mains plug with wet hands.
- Only pull out the mains cable by the plug and never by the cable, as this could damage it.
- Never unplug the mains plug during operation.

Observe the following information and ensure that:

Notes

- The mains voltage and voltage indicated on the washing machine (rating plate) are the same. The connected load and fuse required are specified on the rating plate.
- The washing machine is only connected to an alternating current supply via a properly installed earthed socket.
- The mains plug fits the socket.
- The cable cross-section is adequate.
- The earthing system is properly installed.
- The mains cable is only replaced by a qualified electrician (if this is necessary). Replacement mains cables are available from customer services.
- No multiple plugs/couplings or extension cables are used.
- If an earth-leakage circuit breaker is used, only a type which displays the  symbol is used. Only this symbol guarantees compliance with the currently applicable regulations.
- The mains plug can be accessed at all times.
- The mains cable is not kinked, squashed, altered or cut through.
- The mains cable does not come into contact with heat sources.

Before using the appliance for the first time

The washing machine was thoroughly tested before leaving the factory. To remove any water that may be left over from the test, run the first wash cycle **without** any laundry.

Notes

- The washing machine **must be correctly installed and connected**. From → *Page 14*
- Never use a machine if it is damaged. Inform the after-sales service.

Preparatory work:

1. Check the machine.
2. Remove the protective film from the control panel.
3. Plug in the mains plug.
4. Turn on the tap.

Running the programme without laundry:

1. Switch on the appliance.
2. Close the door (do not load any laundry).
3. Set the **Drum Clean**  **90 °C** programme.
4. Open the detergent drawer.
5. Pour approximately 1 litre of water into compartment **II**.
6. Pour standard washing powder into compartment **II**.

Note: To prevent foaming, only use half the amount of detergent recommended by the detergent manufacturer. Do not use detergents intended for woollens or delicates.

7. Close the detergent drawer.
8. Press the ►|| button.
9. Switch off the appliance at the end of the programme.

Your washing machine is now ready to use.

Transportation

E.g. when moving house

Preparatory work:

1. Turn off the tap.
2. Reduce the water pressure in the supply hose: → *Page 47*; Cleaning and maintenance – filter in the water supply blocked
3. Disconnect the washing machine from the mains.
4. Drain the remaining water: → *Page 46*; cleaning and maintenance – the drain pump is blocked, emergency draining
5. Remove the hoses.

Fitting the transportation securing means:

1. Remove the covers and keep them in a safe place.
If required, use a screwdriver.

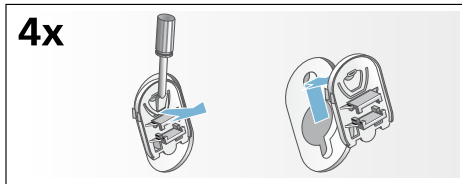

2. Insert all four sleeves.
Clip the mains cable securely in the holders. Insert the transportation securing bolts and tighten them with a wrench (WAF 13).

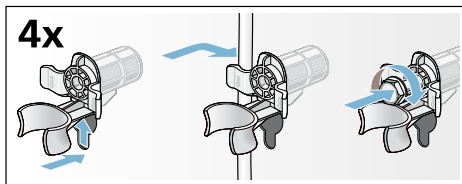

Before switching on the appliance again:

Notes

- The transport braces **must** be removed.
- Pour approx. 1 litre of water into compartment **II**, select the **Empty** programme and start.
This will prevent detergent from flowing unused into the drain during the next wash.



Main points in brief

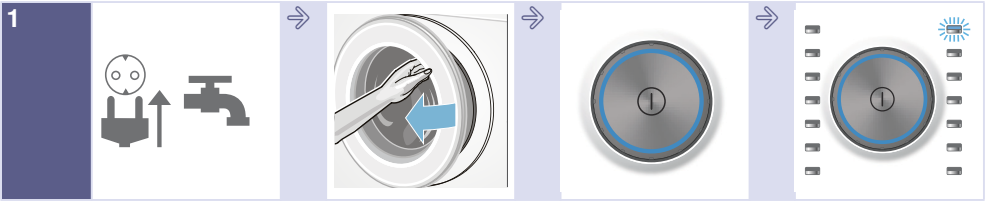

1

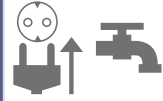

Connect the mains plug. Turn on the tap.

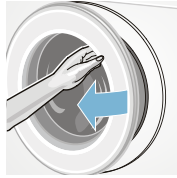

Open the door.



To switch on, press the  button.



Select a programme, e.g. **Cottons**.



2



Sort the laundry.



Observe the maximum load (depending on the model) on the display panel.



Load the laundry.



Close the door.



3

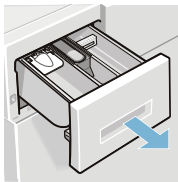

Add detergent.



If necessary, change the default programme settings and/or select additional settings.



Start the programme.

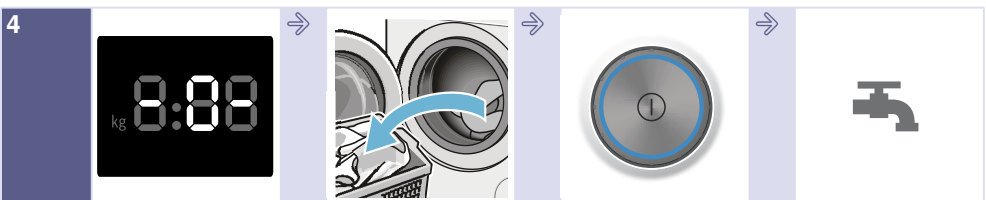

4



End of the programme



Open the door and remove the laundry.



To switch off, press the  button.



Turn off the tap (for models without Aqua-Stop).

Getting to know the appliance

Washing machine

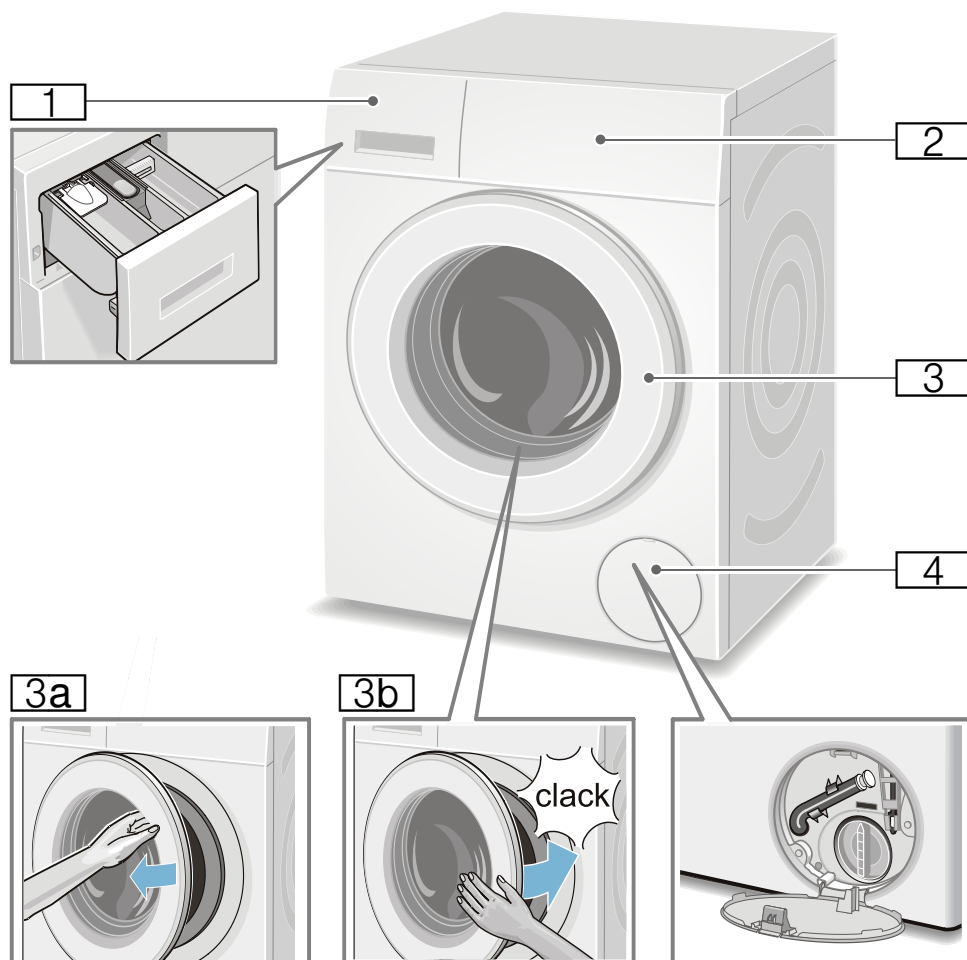

- 1** Detergent drawer → *Page 39*
- 2** Operating/display panel
- 3** Door with door handle
- 3a** Open the door
- 3b** Close the door
- 4** Service flap

Control panel

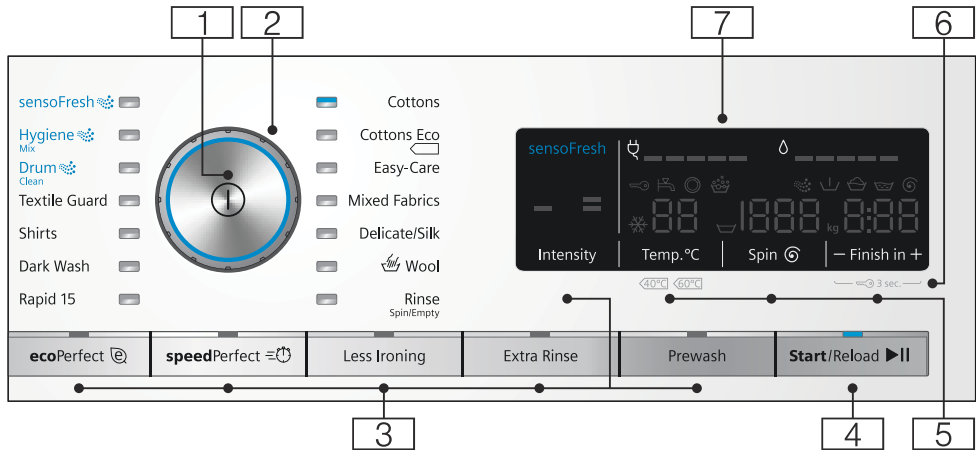

Note: All the buttons are sensitive (except for the main switch) and only need to be pressed lightly.

- 1 Main switch**
for switching the washing machine on and off:
Press the ① button.
- 2 Programme selector**
for selecting a programme.
Programme overview → *Page 30*
- 3 Additional programme settings:**
→ *Page 37*
 - speedPerfect
 - ecoPerfect
 - Prewash ,
 - Extra Rinse,
 - Less Ironing ,
 - sensoFresh Intensity
- 4 ▶|| button for:**
 - Starting a programme,
 - Interrupting a programme, e.g. to add items of laundry
→ *Page 41*,
 - Cancelling a programme
→ *Page 42*

- 5 Changing the default programme settings:** → *Page 36*
 - Temperature (Temp. °C),
 - Spin speed (Spin) ,
 - Finish in
- 6 Child lock** (3 sec.)
to prevent the set functions from being changed accidentally:
To do so, press the **Finish in +** and - buttons at the same time for approx. 3 seconds.
→ *Page 41*
- 7 Display panel** for settings and information. → *Page 26*

Display panel

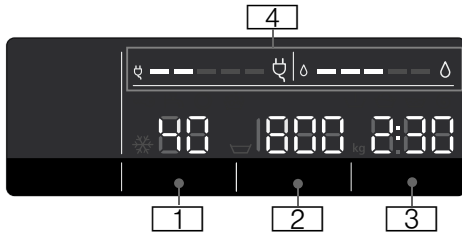







Default programme settings:

- 1 **Temperature** in °C
 - * - 90 (* = cold)
- 2 **Spin speed** in rpm,
 - ▽, 0 - 1600*;
 - * Max. spin speed, depending on the selected programme and model,
 - 0 = no spin cycle, draining only → *Page 36*,
 - ▽ = Rinse Stop → *Page 36*
- 3 **Finish in**
 - e.g. 2:30;
 - Programme duration depends on the programme selection in h:min (hours:minutes)
 - **End time preselection**
 - 1 - 24 h;
 - Programme ends after ... h (h = hours),
 - **Load recommendation**
 - e.g. kg 9*;
 - * depending on the selected programme
- 4 **Information on energy and water consumption:** → *Page 13*
 - ◊ = = = = =
 - Water consumption display,
 - ◊ = = = = =
 - Energy consumption display

Further information

 sensoFresh Intensity
→ Page 37

Programme progress:

	Active oxygen phase
	Prewash
	Wash
	Rinse
	Spin
- 0 -	Programme end
	Programme end during Rinse Stop
- P -	Pause, e.g. to reload laundry

Loading door:

 lights up The washing machine door can be opened.

 flashes When the programme has started: The washing machine door is not closed properly.

Tap:

 lights up Tap not turned on, no water pressure

 flashes Water pressure too low (may increase the programme duration)

Childproof lock: → Page 41

 lights up Childproof lock activated

 flashes Childproof lock activated, programme selector adjusted

Foam detection function:

 lights up → Page 40

Fault display:

E: - - → Page 49

Signal setting:

0 - 4 → Page 43

Further information**Automatic switch-off** of the appliance:

On OFF → Page 13, → Page 43



Laundry

Prepare the laundry

Caution!

Damage to the appliance/fabrics

Foreign objects (e.g. coins, paperclips, needles, nails) may damage the laundry or components in the washing machine.

You should therefore note the following tips when preparing your laundry:

- Empty any pockets.

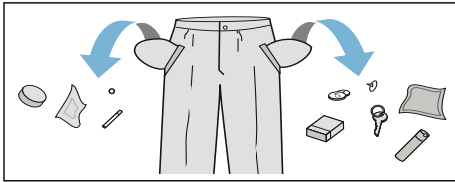

- Look out for metal items (paperclips, etc.) and remove them.
- Wash delicates in a laundry bag (tights, underwired bras, etc.).
- Close any zips; button up any cover buttons.
- Brush sand out of pockets and collars.
- Remove curtain fittings or place curtains in a laundry bag.

Sorting laundry

Sort your laundry according to the care instructions and manufacturer's information on the care labels, depending on:







- Type of fabric/fibre
- Colour
 - Note:** Laundry may discolour. Wash white and coloured items separately. Wash new coloured items separately the first time you wash them.
- Soiling
 - Wash laundry with the same level of soiling together.

Some examples of soiling levels can be found on → *Page 29*

- **Light:** Do not prewash, select the **speedPerfect**  setting if necessary
- **Normal**
- **Heavy:** Load less laundry, select a programme with prewash
- **Stains:** Remove/pretreat stains while they are fresh. Firstly, dab with soapy water; do not rub. Then wash the items of laundry with the appropriate programme. Stubborn or dried-in stains can sometimes only be removed by washing several times.

- Symbols on the care labels

Note: The numbers in the symbols indicate the maximum washing temperature that may be used.

-  Suitable for normal washing process; e.g. Cottons programme
-  A gentle washing process is required; e.g. Easy-Care programme
-  An especially gentle washing process is required; e.g. Delicate/Silk programme
-  Suitable for washing by hand; e.g.  Woollens programme
-  Do not machine wash.

Detergent

Correct selection of detergent

The care label is crucial for selecting the correct detergent, temperature and treatment of the laundry. → See also www.sartex.ch

If you visit www.cleanright.eu, you will find further information on detergents, care products and cleaning agents for domestic use.

- **Standard detergent with optical brighteners**

Suitable for boil-washable white laundry made from linen or cotton
Programme: Cottons/
cold - max. 90 °C

- **Detergent for colours without bleach or optical brighteners**

Suitable for coloured laundry made from linen or cotton
Programme: Cottons/
cold - max. 60 °C

- **Detergent for colours/delicates without optical brighteners**

Suitable for coloured laundry made from easy-care fibres, synthetic fibres
Programme: Easy-Care/
cold - max. 60 °C

- **Detergent for delicates**

Suitable for delicate, fine fabrics, silk or viscose
Programme: Delicate/Silk/
cold - max. 40 °C

- **Detergent for woollens**

Suitable for wool
Wool programme/
cold - max. 40 °C

Saving energy and detergent

For light and normal soiling, you can save energy (lower washing temperature) and detergent.







Saving	Soiling/note
Reduced temperature and detergent quantity as per the recommended dosage	<p>Light No visible dirt or stains. Clothing has taken on some body odour, e.g.:</p> <ul style="list-style-type: none"> ■ Light summer/sports clothing (worn for a few hours) ■ T-shirts, shirts, blouses (worn for up to one day) ■ Guest bed linen and hand towels (used for one day)
	<p>Normal Visible dirt or a few light stains, e.g.:</p> <ul style="list-style-type: none"> ■ T-shirts, shirts, blouses (sweat soaked, worn a few times) ■ Towels, bedding (used for up to one week)
	<p>Heavy Dirt and/or stains clearly visible, e.g. tea towels, baby items, work clothing</p>
Temperature as per the care label and detergent quantity as per the recommended dosage for heavy soiling	







Note: When measuring the amount of all detergents/additives/care products and cleaning agents, please always check the manufacturer's instructions and information. → *Page 39*









Overview of programmes

Programmes on the programme selector

Programme/Type of laundry/Instructions	Settings
<p>Name of the programme</p> <p>Brief explanation of the programme and for which fabrics it is suitable.</p>	<p>Max. load</p> <p>Temperature that can be selected (☼ = cold)</p> <p>Spin speed that can be selected**; ☐ = Rinse Stop, 0 = no spin cycle, draining only</p> <p>programme additional settings that can be selected</p>
<p>Cottons</p> <p>Hard-wearing fabrics, heat-resistant fabrics made of cotton or linen</p> <p>Note: . The speedPerfect ☐ setting is suitable as a short programme for lightly soiled laundry.</p>	<p>Max. 9 kg/5* kg</p> <p>☼ - 90 °C</p> <p>☐, 0 - 1600** rpm</p> <p>ecoPerfect @, speedPerfect ☐, Prewash , Extra Rinse, Less Ironing</p>
<p>Cottons Eco ☐</p> <p>Hard-wearing fabrics, heat-resistant fabrics made of cotton or linen;</p> <p>Energy-optimised washing by reducing the temperature while achieving a comparable washing result for the Cottons programme.</p> <p>Note: . The washing temperature is lower than the selected temperature. If you want to achieve a higher water temperature, use the Cottons programme with a higher temperature as required.</p>	<p>Max. 9 kg</p> <p>☼ - 90 °C</p> <p>☐, 0 - 1600** rpm</p> <p>Prewash , Extra Rinse, Less Ironing</p>
<p>Easy-Care</p> <p>Textiles made of synthetic materials or blended fabrics</p>	<p>Max. 4 kg</p> <p>☼ ... 60 °C</p> <p>☐, 0 - 1200 rpm</p> <p>ecoPerfect @, speedPerfect ☐, Prewash , Extra Rinse, Less Ironing</p>
<p>* Reduced load for the speedPerfect ☐ setting</p> <p>** Max. spin speed, depending on the model</p> <p>*** Programme depending on the model</p>	

Programme/Type of laundry/Instructions	Settings
Mixed Fabrics Mixed load of cottons and synthetic fabrics	Max. 4 kg ❄ - 40 °C 🌀, 0 - 1600** rpm ecoPerfect  , speedPerfect  , Prewash , Extra Rinse, Less Ironing
Delicate / Silk For delicate, washable fabrics, e.g. made of silk, satin, synthetic fibres or blends (e.g. silk blouses, silk scarves) Note: . Use a detergent that is suitable for machine-washing delicate fabrics or silk.	Max. 2 kg ❄ - 40 °C 🌀, 0 - 800 rpm ecoPerfect  , speedPerfect  , Prewash , Extra Rinse, Less Ironing
 Wool Hand- or machine-washable fabrics that are made of wool or contain wool; particularly gentle wash programme to prevent laundry from shrinking, with longer pauses in the programme (during which the items rest in the water) Notes <ul style="list-style-type: none"> ■ Wool is of animal origin, e.g. angora, alpaca, llama, sheep. ■ Use a detergent that is suitable for machine-washing wool. 	Max. 2 kg ❄ - 40 °C 🌀, 0 - 800 rpm -
Rinse / Spin / Empty Combined extra programme for rinsing and spinning the laundry, and draining the rinsing water Note: . The Extra Rinse button is activated at the factory for this programme. If you only want to spin the laundry: Deactivate the Extra Rinse button and, if required, adjust the spin speed. If you only want to drain the water: Deactivate the Extra Rinse button and select the spin speed 0 .	- - 🌀, 0 - 1600** rpm Extra Rinse, Less Ironing
* Reduced load for the speedPerfect  setting ** Max. spin speed, depending on the model *** Programme depending on the model	

Programme/Type of laundry/Instructions	Settings
<p>sensofresh </p> <p>Mixed load of cottons, synthetic fabrics, silk, satin, wool; programme suitable for removing odours, e.g. the smell of cigarettes and kitchen odours → Page 35</p> <p>Notes</p> <ul style="list-style-type: none"> ■ Observe max. load. ■ Not a washing programme/not suitable for removing stains and sweat. ■ Load dry laundry only. ■ Before loading the laundry, wipe the drum dry if necessary, turning it as you do so to remove all water. 	<p>Max. 1 kg</p> <p>-</p> <p>-</p> <p>sensofresh Intensity</p>
<p>Drum Clean </p> <p>The cleaning programme, combined with an active oxygen phase followed by a washing programme, thoroughly cleans and cares for the drum and outer tub, and eliminates odours.</p> <p>Run the programme, e.g.:</p> <ul style="list-style-type: none"> ■ before using the appliance for the first time, ■ if you regularly wash at low temperatures (40 °C or lower) or ■ if there are odours due to a long absence. <p>Notes</p> <ul style="list-style-type: none"> ■ The Drum Clean  indicator lamp flashes when you use have not used a programme at 60 °C or higher for a long time. ■ Run the programme without laundry. ■ Use washing powder or a detergent containing bleach. To prevent foaming, only use half the amount of detergent recommended by the detergent manufacturer. Do not use detergent designed for woollens or delicates. 	<p>0 kg</p> <p>80, 90 °C</p> <p>1200 rpm</p> <p>-</p>
<p>rapid 15'</p> <p>Extra-short programme of approx. 15 minutes, suitable for small items of lightly soiled laundry</p>	<p>Max. 2 kg</p> <p> - 40 °C</p> <p>, 0 - 1200 rpm</p> <p>-</p>
<p>* Reduced load for the speedPerfect  setting</p> <p>** Max. spin speed, depending on the model</p> <p>*** Programme depending on the model</p>	

Programme/Type of laundry/Instructions	Settings
<p>Dark Wash</p> <p>Dark-coloured cottons and dark-coloured easy-care fabrics; Turn items inside-out before washing.</p>	<p>Max. 3.5 kg</p> <p>❄ - 40 °C</p> <p>☒, 0 - 1200 rpm</p> <p>ecoPerfect , speedPerfect ,</p> <p>Prewash ,</p> <p>Extra Rinse,</p> <p>Less Ironing</p>
<p>Hygiene Mix </p> <p>Mixed load of cottons, synthetic fabrics, silk, satin; The washing programme, combined with an active oxygen laundry treatment followed by a washing programme, is particularly suitable for delicate fabrics with high hygiene requirements.</p>	<p>Max. 4 kg</p> <p>❄ - 40 °C</p> <p>☒, 0 - 1600** rpm</p> <p>ecoPerfect , speedPerfect ,</p> <p>Prewash ,</p> <p>Extra Rinse,</p> <p>Less Ironing</p>
<p>*** Textile Guard</p> <p>Wash cycle followed by waterproofing of membrane-coated weatherproof and outdoor clothing or water-resistant fabrics</p> <ol style="list-style-type: none"> 1. Select a programme. 2. Add special detergent for outdoor clothing to compartment II. 3. Add a waterproofing agent (max. 170 ml) to compartment . 4. Press the ▶ button. After-treat the laundry in accordance with the manufacturer's instructions. <p>Notes</p> <ul style="list-style-type: none"> ■ Use a special detergent suitable for machine washing and dose in accordance with the manufacturer's instructions: ■ Laundry must not be treated with fabric softener. ■ Before washing, clean the detergent drawer thoroughly (all compartments) to remove fabric softener residue. 	<p>Max. 1 kg</p> <p>❄ - 40 °C</p> <p>☒, 0 - 800 rpm</p> <p>ecoPerfect , speedPerfect ,</p> <p>Extra Rinse,</p>
<p>* Reduced load for the speedPerfect  setting</p> <p>** Max. spin speed, depending on the model</p> <p>*** Programme depending on the model</p>	

Programme/Type of laundry/Instructions	Settings
<p>*** Outdoor</p> <p>Membrane-coated weatherproof or outdoor clothing and water-resistant fabrics</p> <p>Notes</p> <ul style="list-style-type: none"> ■ Use special detergent suitable for machine-washing; add the correct dosage to compartment II in accordance with the manufacturer's instructions. ■ Laundry must not be treated with fabric softener. ■ Before washing, clean the detergent drawer thoroughly (all compartments) to remove fabric softener residue. 	<p>Max. 2 kg</p> <p>✳ - 40 °C</p> <p>☒, 0 - 800 rpm</p> <p>ecoPerfect @, speedPerfect ≡☒, Extra Rinse,</p>
<p>Shirts</p> <p>Non-iron shirts or blouses made of cotton, linen, synthetic fibres or blended fabrics</p> <p>Notes</p> <ul style="list-style-type: none"> ■ Shirts/blouses are only given a short spin on the Less Ironing setting. Hang them up to dry while still dripping wet. → Self-smoothing effect ■ Use the Delicate / Silk programme to wash shirts/blouses made of silk or delicate fabrics. 	<p>Max. 2 kg</p> <p>✳ - 60 °C</p> <p>☒, 0 - 800 rpm</p> <p>ecoPerfect @, speedPerfect ≡☒, Prewash , Extra Rinse, Less Ironing</p>
<p>* Reduced load for the speedPerfect ≡☒ setting</p> <p>** Max. spin speed, depending on the model</p> <p>*** Programme depending on the model</p>	

sensoFresh

sensoFresh  is an innovative programme that is designed to refresh laundry and remove odours (e.g. the smell of cigarettes and kitchen odours). Sweaty fabrics must be washed.

In this programme, your laundry is treated with active oxygen and water mist; detergent is not added.



Active oxygen is a special type of oxygen which effectively reduces odours.

The programme is suitable for all types of material and fabric, even for those which should only be professionally cleaned.

Once the programme has started, the drum inside the appliance lights up and the mist that is created can be seen.

Once the programme has finished, take the laundry out of the drum and shake it out briefly.

Notes

- Leave the door and detergent drawer open slightly when the appliance is not in use. → *Page 44*
- The active oxygen treatment is less effective if the drum is dirty. Run the **Drum Clean**  programme regularly.
- It is not possible to add laundry once the programme has started.
- If you cancel the programme or switch to a different one, the door will remain locked until there is no longer any active oxygen in the drum. This may take up to 25 minutes. The two symbols  and  will flash during this time. The door will then unlock automatically.

Starching

Note: Laundry should not be treated with fabric softener.



Liquid starch can be used to stiffen fabrics particularly in the Rinse and Cottons programmes. Measure starch into compartment  in accordance with the manufacturer's instructions (clean first if necessary).

Dyeing/bleaching

Dye should only be used in normal household quantities. Salt may damage stainless steel. Always follow the dye manufacturer's instructions.

Do **not** use the washing machine to bleach clothes.

Soaking

1. Switch on the appliance.
2. Select the **Cottons 30 °C** programme.
3. Pour soaking agent/detergent into compartment **II** in accordance with the manufacturer's instructions.
4. Press the  button. The programme starts.
5. After approx. 10 minutes, press the  button to pause the programme.
6. Leave the laundry to soak for as long as required, then either press the  button again to continue the programme or change the programme.

Notes

- Load laundry of the same colour.
- No additional detergent is required; the soaking solution is used for washing.

P+ Programme default settings

The default programme settings are displayed in the display panel after selecting the programme.

You can change the default settings.

An overview of all programme settings, which can be selected depending on the programme, can be found from → *Page 30*.

Temperature

(Temp. °C)

Depending on what stage the programme is in, you can change the set temperature before and during the programme.

The maximum temperature that can be set depends on the programme that has been selected.

Spin speed

(Spin )

Depending on what stage the programme is in, you can change the spin speed (in rpm; revolutions per minute) before and during the programme.

Setting 0: The rinsing water is drained but there is no final spin. The laundry stays wet inside the drum, e.g. for items that should not be spun.

Setting : Rinse Stop = no final spin. The laundry stays in the water after the final rinse.

You can select "Rinse Stop" to prevent creasing if the laundry will not be taken out of the washing machine immediately after the programme has ended.

To continue/end the programme
→ *Page 42*

The maximum speed that can be set depends on the model and programme that has been selected.

Finish in

Before starting the programme, you can preselect the programme end ("Ready in" time) in hourly increments (h = hour) up to a maximum of 24 hours.

To do this:

1. Select a programme.
The programme duration is displayed for the selected programme, e.g. **2:30** (hours:minutes).
2. Press the **Finish in** button repeatedly until the required number of hours is displayed.
Note: The setting values are increased using the **Finish in +** button, and decreased using the **Finish in -** button.
3. Press the **▶||** button.
The programme starts.
The selected number of hours (e.g. **8 h**) is shown in the display panel and counts down until the wash programme starts. The duration of the programme is then displayed.

Note: The length of the programme is automatically adjusted when the programme is running. Changes to the default programme settings or programme settings may also change the programme duration.

After starting the programme (if a Finish in time has been selected and the wash programme has not yet started), you can change the preselected number of hours as follows:

1. Press the ►|| button.
2. Use the **Finish in -** or **+** button to change the number of hours.
3. Press the ►|| button.

After starting the programme, you can add or remove laundry if necessary.

→ Page 41

P+ Additional programme settings

An overview of all additional settings, which can be selected depending on the programme, can be found from → Page 30.

speedPerfect

Washing in a shorter time while achieving a washing result that is consistent with, but uses more energy than, the selected programme, without the speedPerfect  setting.

Note: Do not exceed the maximum load.

Overview of programmes → Page 30

ecoPerfect

Energy-optimised washing by reducing the temperature while achieving a washing result that is consistent with the selected programme, without the ecoPerfect  setting.

Prewash

For heavily soiled laundry.

Note: Pour detergent into compartments **I** and **II**.

Extra Rinse

Additional rinse cycle for particularly sensitive skin and/or for areas with very soft water.



Less Ironing

Reduces creasing thanks to a special spin sequence followed by fluffing and reduced spin speed.

Note: The washing's residual moisture is increased.

sensoFresh Intensity

The intensity of the active oxygen treatment can be set at 2 levels:

-  normal; for light odours
-  intensive; for strong odours (cigarettes, kitchen odours)



Operating the appliance

Preparing the washing machine

Note: The washing machine **must be correctly installed** and **connected**.

From → *Page 14*.

1. Connect the mains plug.
2. Turn on the tap.
3. Open the door.
4. Check that the drum is completely drained. Drain if necessary.

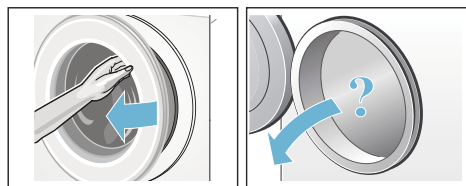

Switching on the appliance/ selecting a programme

Press the  button. The appliance is switched on.

The **Cottons** programme set at the factory is then always displayed.

You can use this programme or select a different programme. The programme selector can be turned in either direction.

Note: If you have activated the childproof lock, you must deactivate it before you can set a different programme. → *Page 41*

The indicator light on the programme selector lights up and the **default programme settings** for the selected programme appear in the display panel:

- Temperature
- Spin speed
- The maximum load and the duration of the programme (alternately)
- Information on water and energy consumption

In appliances with a **drum light**:

The drum is lit after switching on the appliance, after opening and closing the door and after starting the programme. The light switches off automatically.

Placing laundry into the drum



Warning **Danger of death!**

Items of laundry pretreated with cleaning agents that contain solvents, e.g. stain remover/cleaning solvent, may cause an explosion after being loaded into the washing machine. Hand-rinse these items of laundry thoroughly beforehand.

Notes

- Mix items of laundry of varying sizes. Laundry items of different sizes distribute themselves better during the spin cycle. Individual laundry items may cause an unbalanced load.
 - Observe the maximum specified load. Overfilling adversely affects the washing result and promotes creasing.
1. Unfold presorted laundry items and place them in the drum.
 2. Make sure that no items of laundry are trapped between the door and the rubber seal, and close the door.

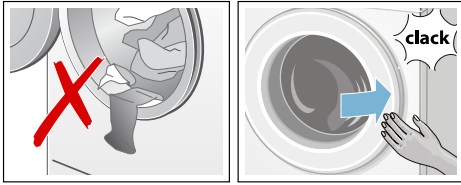

The ►|| button indicator lamp flashes and the programme settings appear in the display panel.

Measure and add detergent and care products

Caution!

Damage to the appliance

Cleaning agents and agents for pre-treating laundry (e.g. stain removers, prewash sprays, etc.) may cause damage if they come into contact with the surfaces of the washing machine. Do not allow these agents to come into contact with the surfaces of the washing machine. If necessary, immediately wipe away spray residue and other residues/droplets with a damp cloth.

Dosing

Dose the detergents and care products according to:

- Water hardness (ask your water supply company)
- The manufacturer's instructions on the packaging
- The amount of laundry
- Soiling → *Page 29*

Filling

⚠ Warning Eye/skin irritation!

Detergents and care products may spray out if the detergent drawer is opened while the machine is in operation. Open the drawer carefully. Rinse eyes/skin thoroughly if they come into contact with detergents or care products. If accidentally swallowed, seek medical advice.

Note: Dilute viscous fabric softener and fabric conditioner with a little water. This prevents blockages in the washing machine's piping.

Pour the detergent and care products into the appropriate compartments:

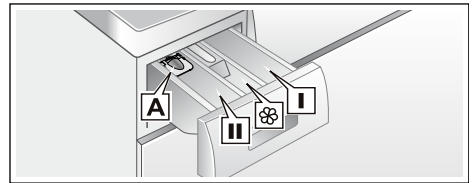

- | | |
|------------------------|--|
| Measuring aid A | For liquid detergent |
| Compartment II | Detergent for the main wash, water softener, bleach, stain remover |
| Compartment ☼ | Fabric softener, liquid starch; do not exceed max. |
| Compartment I | Detergent for prewash |

1. Pull out the detergent drawer as far as possible.
2. Add detergent and/or care products.
3. Close the detergent drawer.

Measuring aid* for liquid detergent

*depending on the model

Position the measuring aid for dosing the correct amount of liquid detergent:

1. Pull out the detergent drawer. Press down the insert and fully remove the drawer.
2. Slide the measuring aid forwards, fold it down and click it into place.
3. Reinsert the drawer.

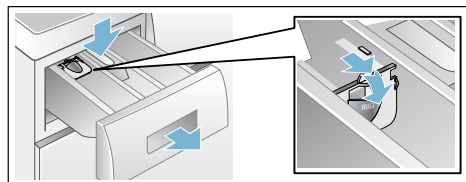

Note: Do not use the measuring aid for gel detergents and washing powder, or for programmes with prewash or when the "Ready in" time is selected.

For models without a measuring aid, pour the liquid detergent into the appropriate dispenser and place it in the drum.

Change the programme default settings

You can use or change the default settings for this washing cycle.

To do this, repeatedly press the corresponding button until the required setting is displayed.

Note: Pressing and holding the button automatically runs through the set values to the end. Then press the button once more and you can then change the setting values again.

The settings are activated without needing to be confirmed.

The settings are not saved after switching off the washing machine.

Default programme settings → Page 36

Select additional programme settings

By selecting additional settings, you can better adapt the washing process to your items of laundry.

The settings can be selected or deselected depending on the programme progress.

The button indicator lamps light up if a setting is activated.

The settings are not saved after switching off the washing machine.

Additional programme settings
→ Page 37

Start the programme

Press the ► button. The indicator lamp lights up and the programme starts.

The display panel shows the "Ready in" time while the programme is running or the programme length and the programme progress symbols when the washing programme has started.
Display panel → Page 26

Note: Foam detection

If the 🍽️ symbol also lights up in the display panel, the washing machine has detected too much foam during the wash programme and automatically activated additional rinse cycles to remove the foam.

Add less detergent to the next washing cycle with the same load.



If you want to lock the programme to prevent it from being inadvertently adjusted, you can select the childproof lock as follows.

Child lock

( 3 sec.)

You can lock the washing machine to prevent the functions you have set from being changed inadvertently. To do this, activate the childproof lock.

To **activate/deactivate**, press and hold the **Finish in -** and **+** buttons at the same time for approx. three seconds. The  symbol appears in the display panel.

-  lights up: The childproof lock is active.
-  flashes briefly: The childproof lock is active and the programme selector was turned or a button was pressed.

Note: The childproof lock remains active, even once the washing machine has been switched off. Before selecting the next programme, deactivate the childproof lock.

Adding laundry

After starting the programme, you can add or remove laundry if necessary.

Press the  button to do this.

The  button indicator lamp flashes and the machine checks whether it is possible to add laundry.

If the following appears in the display panel:

- **Both** the - P - and  symbols light up, it is possible to add laundry.
- - P - lights up, it is not possible to add laundry.



To continue the programme, press the  button. The programme continues automatically.

Notes



- Do not leave the door open for too long when adding laundry as water from the laundry may leak out.
- For safety reasons, the door remains locked when the water level or temperature is high, while the drum is turning or during the active oxygen phase, and it is not possible to add laundry during this time.
- It is possible to add laundry during the sensoFresh  programme.
- The load display is not active during reloading.

Changing the programme

If you have started the wrong programme by mistake, you can change the programme as follows:

1. Press the  button.
2. Select another programme.
3. Press the  button. The new programme starts from the beginning.

Note: When switching from programmes that use active oxygen to those that do not, the door will remain locked for up to 25 minutes until there is no longer any active oxygen in the drum.

The  and  symbols will flash. If the symbols are off, the door can be opened.

Cancel the programme

For programmes at high temperatures:

1. Press the ►|| button.
2. To cool down laundry: Select **Rinse**.
3. Press the ►|| button.

For programmes at low temperatures:

1. Press the ►|| button.
2. Select **Spin** or **Empty**.
3. Press the ►|| button.

Note: When cancelling programmes that use active oxygen, the door will remain locked for up to 25 minutes until there is no longer any active oxygen in the drum.

Switch the appliance on again if necessary. The ☉ and 🌀 symbols will flash. If the symbols are off, the door can be opened.

Programme end during rinse hold

In the display panel, ☹ flashes, and the preset spin speed and remaining programme length are displayed for the selected programme.

Continue the programme by:

- Pressing the ►|| button or
- Changing the spin speed, or setting the programme selector to **Empty** and then pressing the ►|| button.

Programme end

- 0 - and ☉ appear in the display panel. The ►|| button indicator lamp is off.

Removing laundry/switching off the appliance

1. Open the door and remove the laundry.
2. Press the ① button. The appliance is switched off.
3. Turn off the tap.

Note: Not required for Aqua-Stop models.

Notes

- Do not leave any items of laundry in the drum. They may shrink in the next wash or discolour another item.
- Remove any foreign objects from the drum and the rubber seal – risk of rusting.
- Wipe the rubber seal dry.

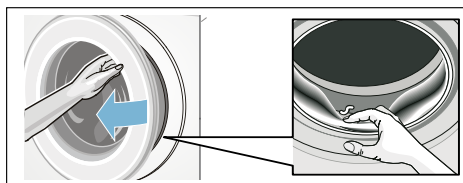

- Leave the door and detergent drawer open so that any residual water can evaporate. → Page 44
- Always wait until the programme ends, as the appliance could still be locked. Then switch the appliance on and wait for it to unlock.
- If the display panel goes off at the end of a programme, the energy-saving mode is active. Press any button to activate the panel.

Appliance settings

You can change the following settings:

- The volume of the buttons and the information signals (e.g. at the end of the programme)
- Select/deselect the appliance's automatic switch-off function → *Page 13*
- Switch the drum-care information signal on/off (depending on the model). From → *Page 30* onwards

You will need to activate the setting mode in order to change these settings.

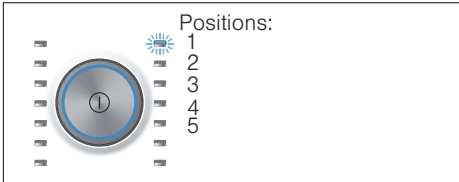

Activating the setting mode

1. Press the **ⓘ** button.
The appliance is switched on and the **Cottons** programme is shown at position 1.
2. Press the **Temperature** button and, at the same time, turn the programme selector clockwise to position 2. Release the button.
The setting mode is activated and the preset volume for the information signals appears in the display panel.

You can now change the settings:

Changing the signal volume

Use the **Finish in +** or **-** button to change the following settings at the corresponding programme selector positions:

- 2: The volume of the information signals and/or
- 3: The volume of the button signals.



0 = off,
1 = quiet,
2 = medium,
3 = loud,
4 = very loud

Exit setting mode or:

Selecting/deselecting the appliance automatic switch-off

With the programme selector in position 4, press the **Finish in +** or **-** button to turn the automatic switch-off function on or off.

Exit setting mode or:

Switching the drum-care information signal on/off

depending on the model

With the programme selector in position 5, press the **Finish in +** or **-** button to switch the **Drum Clean**  information signal on or off.

Exiting setting mode

To exit and save the settings, press the **ⓘ** button.

The appliance is switched off. The selected settings will take effect the next time the washing machine is switched on.



Sensors

Automatic load sensing

Depending on the type of fabric and load, the automatic load sensing function optimally adjusts the water consumption and programme duration in each programme.

Unbalanced load detection system

The automatic unbalanced load detection system detects imbalances and ensures even distribution of the laundry by repeatedly starting and stopping drum spinning.

If the laundry is extremely unevenly distributed, the speed is reduced or the spin cycle is not performed for safety reasons.

Note: Place large and small items of laundry evenly in the drum.
→ Page 38, → Page 50

AquaSensor

depending on the model

During the rinse cycle, the AquaSensor checks the degree of turbidity (turbidity is caused by dirt and detergent residue) of the rinsing water. The duration and the number of rinse cycles depend on the turbidity of the water.



Cleaning and maintenance



Warning

Danger of death!

There is a risk of electric shock if you touch live components. Switch off the appliance and pull out the mains plug.



Warning

Risk of poisoning!

Toxic vapours can be produced by cleaning agents that contain solvents, e.g. cleaning solvent. Do not use cleaning agents that contain solvents.

Caution!

Damage to the appliance

Cleaning agents that contain solvents, e.g. cleaning solvent, can damage surfaces and components in the machine.

Do not use cleaning agents that contain solvents.

Prevent detergent residue from building up and odours from forming by following these instructions:

Notes

- Ensure the room in which the washing machine is set up is well ventilated.
- Leave the door and detergent dispenser tray open slightly when the washing machine is not in use.
- Occasionally run a wash using the **Cottons 60 °C** programme and powder detergent.

Machine housing/control panel

- Wipe the housing and the control panel with a soft, damp cloth.
- Remove the detergent residue immediately.
- Do not clean with a water jet.

Drum

Use chlorine-free cleaning agents, do not use steel wool.

If there are odours in the washing machine, or to clean the drum, run the **Drum Clean**  **90 °C** programme without laundry. Add washing powder.

Descaling

Descaling should not be necessary if the detergent is measured out correctly. However, if it is required, follow the manufacturer's instructions for the descaling agent. Suitable descalers can be obtained via our website or from customer services. → *Page 52*

Detergent drawer and housing

If the washing machine contains detergent or fabric softener residues:

1. Pull out the detergent drawer. Press down the insert and fully remove the drawer.
2. To remove the insert: Push the insert upwards from below with your finger.

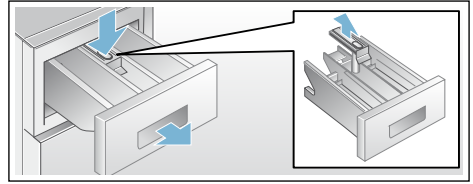

3. Clean the detergent dispenser tray and insert with water and a brush, and dry it. Clean the inside of the housing as well.
4. Fit the insert and lock it in place (push the cylinder onto the guide pin).
5. Push in the detergent drawer.

Note: Leave the detergent drawer open so that any residual water can evaporate.

The drain pump is blocked, emergency draining



Warning Risk of scalding!

When you wash at high temperatures, the water gets very hot. If you come into contact with the hot water, you may be scalded.

Allow the water to cool down.

1. Turn off the tap so that no more water can flow in and has to be drained via the drain pump.
2. Switch off the appliance. Pull out the mains plug.
3. Open and remove the service flap.

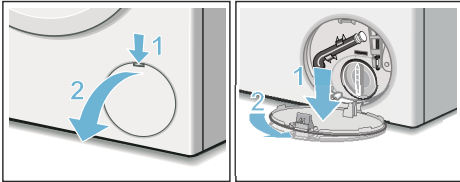

4. Take the drain hose out of the retainer.
Remove the sealing cap and pour the water out into a suitable container.
Replace the sealing cap and place the drain hose back in the retainer.

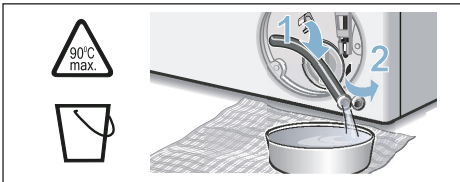

5. Carefully unscrew the pump cover; residual water may leak out.
Clean the interior, pump-cover thread and pump housing. The impeller in the drain pump must be able to rotate.
Refit the pump cover and screw it on tightly. The handle must be in a vertical position.

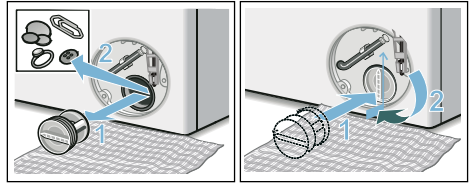

6. Place the service flap back on, lock it into place, and close it.

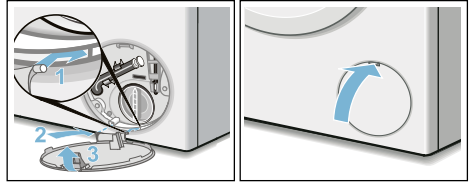

Note: To prevent unused detergent from flowing straight into the drain during the next wash: Pour 1 litre of water into compartment **II** and start the **Empty** programme.

The drain hose at the siphon is blocked

1. Switch off the appliance. Pull out the mains plug.
2. Loosen the hose clamp. Carefully remove the drain hose; residual water may leak out.
3. Clean the drain hose and siphon connecting piece.

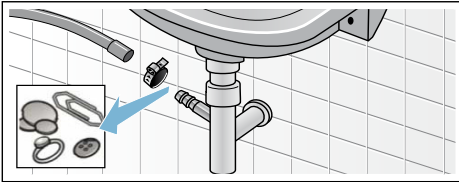

4. Re-attach the drain hose and secure the connection point using the hose clamp.

Filter in the water supply blocked

First, reduce the water pressure in the supply hose:

1. Turn off the tap.
2. Select any programme (except Rinse/Spin/Empty).
3. Press the ►|| button. Allow the programme to run for approximately 40 seconds.
4. Press the Ⓛ button. The appliance is switched off.
5. Pull out the mains plug.

Then clean the filter:

1. Disconnect the hose from the tap. Clean the filter with a small brush.

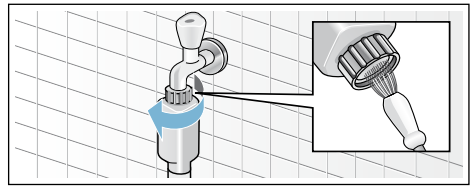

2. For standard and Aqua-Secure models, clean the filter on the rear of the appliance: Remove the hose from the rear of the appliance. Use pliers to remove the filter and then clean it.

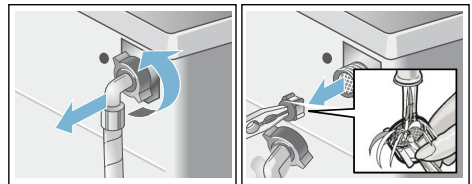

3. Connect the hose and check for leaks.

Faults and what to do about them.

Emergency release

E.g. in the event of a power cut

The programme continues when the power supply is restored.

However, if the laundry has to be removed, the washing machine door can be opened as follows:

Warning **Risk of scalding!**

When you are washing at high temperatures, there is a risk of scalding if you come into contact with hot detergent solution and laundry. If possible, leave it to cool down first.

Warning **Risk of injury!**

Reaching into the drum while it is still turning may cause hand injuries. Do not reach into the drum when it is turning. Wait until the drum has stopped turning.

Warning **Irritation of the respiratory tract!**

Any active oxygen that is emitted may irritate the mucosa and cause eyes to water.

Do not open the door using the emergency release if a programme is running with active oxygen. Wait until there is no active oxygen in the drum.

Caution! **Water damage**







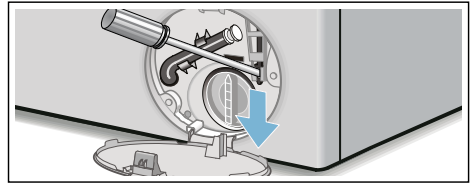

Any escaping water may cause water damage.

Do not open the washing machine door if water can be seen through the glass.

1. Switch off the appliance. Pull out the mains plug.
2. Drain the water. → *Page 46*
3. Use a tool to pull the emergency release downwards and then release.
The washing machine door can then be opened.











Information on the display panel

Indicator/symbol	Cause/remedy
- P - and 	The door is unlocked. It is possible to add laundry.
- P -	<ul style="list-style-type: none"> ■ The temperature is too high. Wait until the temperature drops. ■ The water level is too high. It is not possible to add laundry. Close the door immediately, if necessary. Press the ► button to resume the programme.
 is flashing	<ul style="list-style-type: none"> ■ Laundry may be trapped. Open and close the door again and press the ► button. ■ If necessary, push the door closed or remove the laundry and then push the door closed again. ■ If necessary, switch the appliance off and on again; set the programme and select the individual settings you require; start the programme.
 and the sensoFresh  indicator light are flashing	The door cannot be opened due to the programme. If the lights are off, the door can be opened.
 is lit	<ul style="list-style-type: none"> ■ Turn the tap on fully, ■ Supply hose kinked/trapped, ■ The water pressure is too low. Clean the filter. → <i>Page 47</i>
	The childproof lock is activated – deactivate it. → <i>Page 41</i>
 is lit	Too much foam has been detected and additional wash cycles have been activated. Add less detergent to the next wash cycle with the same load.
The indicator light for the Drum Clean  programme is flashing	<p>Run the Drum Clean  90 °C programme or a 60 °C programme with standard washing powder to clean and care for the drum and the outer tub.</p> <p>Notes</p> <ul style="list-style-type: none"> ■ Run the programme without laundry. ■ Use standard washing powder or a detergent containing bleach. To prevent foaming, only use half the amount of detergent recommended by the detergent manufacturer. Do not use detergents intended for woollens or delicates. ■ Switch the information signal on/off. → <i>Page 43</i>
E:18	<ul style="list-style-type: none"> ■ The drain pump is blocked. Clean the drain pump. → <i>Page 46</i> ■ The drain hose/drain pipe is blocked. Clean the drain hose at the siphon. → <i>Page 47</i>
E:23	There is water in the base trough; the appliance is leaking. Turn off the tap. Call the after-sales service. → <i>Page 52</i>
Other indicators/symbols	Switch off the appliance, wait for five seconds and then switch it on again. If the indicator/symbol appears again, call the after-sales service. → <i>Page 52</i>

Faults and what to do about them.

Faults	Cause/remedy
Water is leaking from the machine.	<ul style="list-style-type: none"> ■ Attach the drain hose correctly or replace it. ■ Tighten the threaded joint on the supply hose.
The appliance is not filling with water.	<ul style="list-style-type: none"> ■ Have you pressed the ► button? ■ Is the tap turned on?
Detergent is not being dispensed.	<ul style="list-style-type: none"> ■ Could the filter be clogged? Clean the filter. → <i>Page 47</i> ■ Is the supply hose kinked or trapped?
The door will not open.	<ul style="list-style-type: none"> ■ The safety function is activated. Have you stopped the programme? → <i>Page 42</i> ■ Is the ☹ childproof lock activated? Deactivate it. → <i>Page 41</i> ■ Is ☹ selected (Rinse Stop = no final spin)? → <i>Page 42</i> ■ Can the door only be opened by the emergency release? → <i>Page 48</i> ■ When switching from a programme that uses active oxygen to one that does not, the door will remain locked for up to 25 minutes until there is no longer any active oxygen in the drum.
The programme will not start.	<ul style="list-style-type: none"> ■ Have you pressed the ► or Finish in button? ■ Is the door closed? ■ Is the ☹ childproof lock activated? Deactivate it. → <i>Page 41</i>
The drum briefly jerks or judders after the programme has started.	Not a fault – the internal motor test may cause the drum to jerk or judder briefly when the wash programme starts.
The water is not draining.	<ul style="list-style-type: none"> ■ Is ☹ selected (Rinse Stop = no final spin)? → <i>Page 42</i> ■ Clean the drain pump. → <i>Page 46</i> ■ Clean the drain pipe and/or the drain hose.
Water is not visible in the drum.	Not a fault – the water is below the visible area.
The spin result is not satisfactory. Laundry wet/too damp.	<ul style="list-style-type: none"> ■ Not a fault – the unbalanced load detection system has interrupted the spin cycle because the laundry is unevenly distributed. Distribute small and large items of laundry evenly in the drum. ■ Is Less Ironing selected (depending on the model)? → <i>Page 37</i> ■ Is the selected speed too low?
The appliance restarts the spin cycle several times.	Not a fault – the unbalanced load detection system is adjusting an imbalance.
The programme is taking longer than usual.	<ul style="list-style-type: none"> ■ Not a fault – the unbalanced load detection system is adjusting an imbalance by repeatedly redistributing the laundry. ■ Not a fault – the foam detection system is on – a rinse cycle has been activated.
The length of the programme changes during the wash cycle.	Not a fault – the programme sequence is optimised for the specific washing process. This may change the length of the programme shown on the display panel.

Faults	Cause/remedy
Water remaining in the care product compartment  .	<ul style="list-style-type: none"> ■ Not a fault – the effectiveness of the care product is not affected. ■ Clean the insert if necessary.
Odours in the washing machine.	<p>Run the Drum Clean  or Cottons 90 °C programme without laundry. Add standard washing powder or a detergent that contains bleach.</p> <p>Note: . To prevent foaming, only use half the amount of detergent recommended by the detergent manufacturer. Do not use detergents intended for woollens or delicates.</p>
The  symbol is lit on the display panel. Foam may also be leaking from the detergent drawer.	<p>Have you used too much detergent?</p> <p>Mix one tablespoon of fabric softener with 1/2 litre of water and pour it into compartment II (not suitable for outdoor clothing, sportswear or items made with down).</p> <p>Use less detergent for the next wash cycle.</p>
Loud noises, vibrations and machine “wandering” during the spin cycle.	<ul style="list-style-type: none"> ■ Is the appliance level? Level the appliance. → <i>Page 20</i> ■ Are the appliance's feet secured? Secure the appliance's feet. → <i>Page 20</i> ■ Have the transportation securing means been removed? Remove the transportation securing means. → <i>Page 16</i>
The display panel/indicator lights do not work while the appliance is running.	<ul style="list-style-type: none"> ■ Has there been a power failure? ■ Have the fuses blown/has the circuit breaker tripped? Switch on the circuit breaker/replace the fuses. ■ If the fault occurs repeatedly, call the after-sales service.
There are noises after the programme starts sensoFresh  .	<p>Not a fault – the appliance is filled with water to create mist; operating noises from the fan and pump can be heard when it is doing this.</p>
Water stains on dry laundry after the sensoFresh  programme.	<ul style="list-style-type: none"> ■ Was residual water removed before laundry was added? ■ Level the appliance. The active oxygen treatment can only work properly if the appliance is levelled correctly. → <i>Page 20</i>
Noises can be heard after the sensoFresh  programme.	<p>Active oxygen leaves a specific odour on the laundry following treatment. Shake out the laundry briefly.</p>
Odour has not been removed satisfactorily after the sensoFresh  programme.	<ul style="list-style-type: none"> ■ The active oxygen treatment is less effective if the drum is dirty. Run the Drum Clean  programme before using the appliance for the first time, and regularly thereafter. ■ Have you loaded too much laundry? Do not exceed the maximum load. ■ Have you selected a high enough intensity? Select a higher intensity. → <i>Page 37</i> ■ Leave the door and detergent drawer open so that any residual water can evaporate. → <i>Page 44</i>
There is detergent residue on the laundry.	<ul style="list-style-type: none"> ■ Some phosphate-free detergents contain water-insoluble residue. ■ Select Rinse or brush the laundry after washing.

Faults	Cause/remedy
- P - appears on the display panel when the cycle is paused.	<ul style="list-style-type: none">■ The water level is too high. It is not possible to add laundry. Close the door immediately, if necessary.■ Press the ► button to resume the programme.
- P - and  appear on the display panel when the cycle is paused.	The door is unlocked. It is possible to add laundry.
If you cannot rectify a fault yourself (after switching the machine off and then on again) or a repair is required:	
<ul style="list-style-type: none">■ Switch off the appliance and pull the mains plug out of the socket.■ Turn off the tap and call the after-sales service.	



After-sales service

If you cannot rectify a fault yourself, contact customer services. → Cover page

We will always find an appropriate solution in order to avoid unnecessary visits by engineers.

Please give customer services the product number (E no.) and the production number (FD) of the appliance.

E-Nr. _____	FD _____
-------------	----------

E no. Product number
FD Production number

You can find this information
*depending on the model:

On the inside of the door*/in the opened service flap* and on the rear of the appliance.

Trust the expertise of the manufacturer.

Contact us for assistance. By doing so, you will ensure that the repairs are carried out by trained service personnel using genuine spare parts.



Consumption rates

Energy and water consumption, programme duration and residual moisture for the main washing programmes







(approximate values)

Programme	Load	Energy consumption*	Water consumption*	Programme duration*
Cottons 20 °C	9 kg	0,25 kWh	90 l	2 ¾ h
Cottons 40 °C	9 kg	1,10 kWh	90 l	3 h
Cottons 60 °C	9 kg	1,06 kWh	90 l	2 ¾ h
Cottons 90 °C	9 kg	2,14 kWh	100 l	2 ¾ h
Easy-Care 40 °C	4 kg	0,71 kWh	64 l	2 h
Mixed Fabrics 40 °C	4 kg	0,60 kWh	45 l	1 ¼ h
Delicate / Silk 30 °C	2 kg	0,19 kWh	37 l	¾ h
Wool 30 °C	2 kg	0,19 kWh	41 l	¾ h
sensoFresh 🌿	1 kg	0,01 kWh	0 l	½ h
sensoFresh 🌿 + sensoFresh Intensity 🌿	1 kg	0,02 kWh	0 l	¾ h
Hygiene 🌿	4 kg	0,61 kWh	44 l	1 ¾ h
Drum Clean 🌿	0 kg	1,41 kWh	27 l	1 ½ h

Programme	Approximate information on the residual moisture**			
	WM16W... Max. 1600 rpm	WM14W... Max. 1400 rpm	WM12W... Max. 1200 rpm	WM10W... Max. 1000 rpm
Cottons	44 %	48 %	53 %	62 %
Easy-Care	40 %	40 %	40 %	40 %
Delicate / Silk	30 %	30 %	30 %	30 %
Wool	45 %	45 %	45 %	45 %
* Observed values may deviate from the indicated values due to influence of water pressure, hardness and inlet temperature, ambient temperature, type, amount and soiling of laundry, detergent used, fluctuations in power supply and selected additional functions.				
** Information on residual moisture based on programme-dependent spin-speed limit and maximum loads.				

Efficiency test programmes for cotton fabrics

The following programmes (standard programmes, indicated by ) are suitable for cleaning normally soiled cotton fabrics and are the most efficient with respect to combined energy and water consumption.

Standard programmes for cottons in accordance with Regulation (EU) no. 1015/2010		
Programme + temperature	Load	Approximate programme duration
Cottons Eco  + 	9 kg	4 ¾ h
Cottons Eco  + 	4,5 kg	4 ½ h
Cottons Eco  + 	4,5 kg	4 ½ h

Programme setting at maximum speed for testing and energy labelling in accordance with Directive 2010/30/EU with cold water (15 °C).
The stated programme temperature is based on the temperature indicated on the care label in the laundry items. The actual washing temperature may differ from the stated programme temperature for energy-saving reasons; the washing performance corresponds to the selected temperature.

Technical data

Dimensions:

850 x 600 x 590 mm

(height x width x depth)

Weight:

70 - 85 kg (depending on model)

Mains connection:

Mains voltage 220 - 240 V, 50 Hz

Nominal current 10 A

Nominal power 1900 – 2300 W

Water pressure:

100 - 1000 kPa (1 - 10 bar)

Power consumption when switched off:

0,12 W

Power consumption when left on:

0,43 W



Aqua-Stop warranty

Only for appliances with Aqua-Stop

In addition to warranty claims against the vendor based on the purchase agreement and to our appliance warranty, we will provide compensation under the following conditions:

1. If water damage is caused due to a fault in our Aqua-Stop system, we will compensate domestic customers for the damage caused.
2. The liability guarantee is valid for the service life of the appliance.
3. It is a prerequisite of all warranty claims that the appliance with Aqua-Stop must have been installed and connected correctly in accordance with our instructions; this also includes a correctly fitted Aqua-Stop extension (genuine accessories). Our warranty does not cover defective feed lines or fittings leading to the Aqua-Stop connection at the tap.
4. Appliances with Aqua-Stop do not need to be supervised during operation, nor secured afterwards by turning off the tap.
The tap only needs to be turned off if you are away from home for a long period, e.g. for several weeks' holiday.

Repair order and advice in the event of faults

GB 0344 892 8999 (Calls charged at local or mobile rate.)

IE 01450 2655 (0.03 € per minute at peak. Off peak 0.0088 € per minute.)

You can find the contact information for all countries in the attached after-sales service directory.

BSH Hausgeräte GmbH

Carl-Wery-Straße 34

81739 München

GERMANY

siemens-home.com

Manufactured by BSH Hausgeräte GmbH under Trademark License of Siemens AG



9001149801 (9602)