



SIEMENS



Washer-Dryer

WD14D361HK, WD14D366HK

siemens-home.com/welcome

en Washer-Dryer
Instruction Manual and Installation Instructions

Register
your
product
online

Your new washer-dryer

You have chosen a Siemens washer-dryer.

Please take a few minutes to read and become familiar with the advantages of your washing machine.

To meet the high quality demands required by Siemens, every washer-dryer that leaves our factory is carefully checked to ensure that it functions correctly and is in perfect condition.

For more information on our products, accessories, replacement parts and services, see our website www.siemens-home.com or contact our after-sales service centres.

If the operating and installation instructions describe different models, any differences will be pointed out at the relevant points in the text.



Read these operating and installation instructions before switching on the washer-dryer.

Contents

Operation instructions	General safety information	4
	Environmental protection/economy tips	6
	Your new washer-dryer	7
	Before washing for the first time	9
	Preparing and sorting the laundry	10
	Detergents and Care Products.....	12
	Programmes.....	14
	Washing and drying options	16
	Washing and drying	18
	Cleaning and care	20
	What to do if... ..	22
	After-sales service	25
Installation instructions	Installation instructions	26
Appendix	Table of programmes.....	30
	Consumption rates.....	31

General safety information

Intended use

- For private domestic use only.
- The washer dryer is suitable for machine washable textiles and hand washable wool and for drying certain types of textiles according to care instructions.
- The appliance is suitable for operation with cold mains water and commercially available detergents and care products which are suitable for use in a washer dryer.
- Always follow the manufacturer's instructions when dosing all detergents, cleaning aids, cleaning products and cleaning agents.
- The washer dryer may be operated by children from 8 years of age, by persons who have limited physical, sensory or mental abilities and by persons who have inadequate experience or knowledge, provided they **are supervised** or **have been instructed** by a responsible person. Children must not perform any cleaning or maintenance work without supervision.
- Keep children under the age of 3 years away from the washer dryer.
- Keep pets away from the washer dryer.
- Install and operate the washer dryer in a room which has an outflow.

This washer-dryer complies with the relevant safety regulations.

Electrical safety

Warning

Danger of death!

Danger of death if live parts are touched.

- When disconnecting the mains plug, always pull the plug itself and not the cable, otherwise the cable could be damaged.
- Never touch or hold the mains plug with wet hands.

Risk of injury

Warning

Risk of injury!

- If the washer dryer is lifted using projecting parts (e.g. the washer dryer door), these components may break off and cause injuries.
- Do not lift the washer dryer by its projecting parts.
- If you climb onto the washer dryer, the worktop may break and cause injuries.
- Do not climb onto the washer dryer.
- If you lean/support yourself on the open door, the washer dryer may overturn and cause injuries.
- Do not lean on the open washer dryer door.
- If you reach into the rotating drum, you may injure your hands.
- Do not grip the rotating drum. Wait until the drum stops rotating.

Warning

Risk of scalding!

- When washing at high temperatures, you may be scalded if you touch the hot washing water (e.g. if draining hot washing water into a washbasin).
- Do not touch the hot washing water.
- If a drying programme was interrupted, the washer dryer and laundry may be very hot. Select **Intensive Dry** ☼ or **Low Heat Dry** ☼ and select 15 min drying time to cool down the washing and then remove.

Safety for children

Warning

Danger of death!

If children play with the washer dryer, they may get into life-threatening situations or injure themselves.

- Do not leave children unattended near the washer dryer.
- Do not let children play with the washer dryer.

Warning

Danger of death!

Children may lock themselves in appliances, putting their lives at risk.

For appliances that have reached the end of their service life:

- Disconnect the mains plug.
- Cut through the mains cable and remove it, along with plug.
- Destroy the lock on the washer dryer door.

Warning

Risk of choking!

Children may become wrapped in packaging/film or packing parts if allowed to play with them, or they may pull them over their heads and suffocate.

Keep packaging, film and packaging parts out of the reach of children.

Warning

Risk of poisoning!

Detergents and care products may be poisonous if consumed.

Keep detergents and care products out of the reach of children.

Warning

Eye / skin irritation!

Detergents and care products may cause irritation if they come into contact with the eyes or skin.

Keep detergents and care products out of the reach of children.

Warning

Risk of injury!

When you wash/dry at high temperatures, the glass in the washer dryer door gets hot.

Do not let children touch the hot washer dryer door.

Environmental protection/economy tips

- Separate out the various waste materials of the packaging and take them to the nearest collection point.
- Always fill the appliance with a maximum amount of laundry for the relevant programme.
- Wash normally soiled laundry without a prewash.
- Instead of **Cottons**  **(Cottons/Coloureds) 90 °C**, select the **Cottons Eco @ 60 °C** programme → page 14.
This gives comparable results, but uses less energy.
- Measure the detergent according to the manufacturer's instructions and in line with the local water hardness.
- If the laundry is subsequently dried in a tumble drier, select the spin speed according to the tumble drier manufacturer's instructions.

WEEE



This appliance is labelled in accordance with European Directive 2012/19/EU concerning used electrical and electronic appliances (waste electrical and electronic equipment - WEEE). The guideline determines the framework for the return and recycling of used appliances as applicable throughout the EU.

Your new washer-dryer

Description of the washer dryer

The washer-dryer can be used in 3 ways -> page 18:

- washing only
- drying only
- successive washing and drying.

The successive wash-dry programme shifts automatically from the wash cycle to the dry cycle without further intervention.

Drying is achieved using the condensation principle. The condensate that is produced during drying runs via the drain hose and into the drainage reservoir.

Caution: the water supply hose and water drain hose must be correctly connected during washing and drying -> page 29. The tap must be open.

Door

A safety device prevents the door from being opened during operation.

Before opening

Make sure that there is no water in the drum and that the drum is not moving.

Emergency release

In the event of a power cut, the door can be released mechanically -> page 24.

Control panel

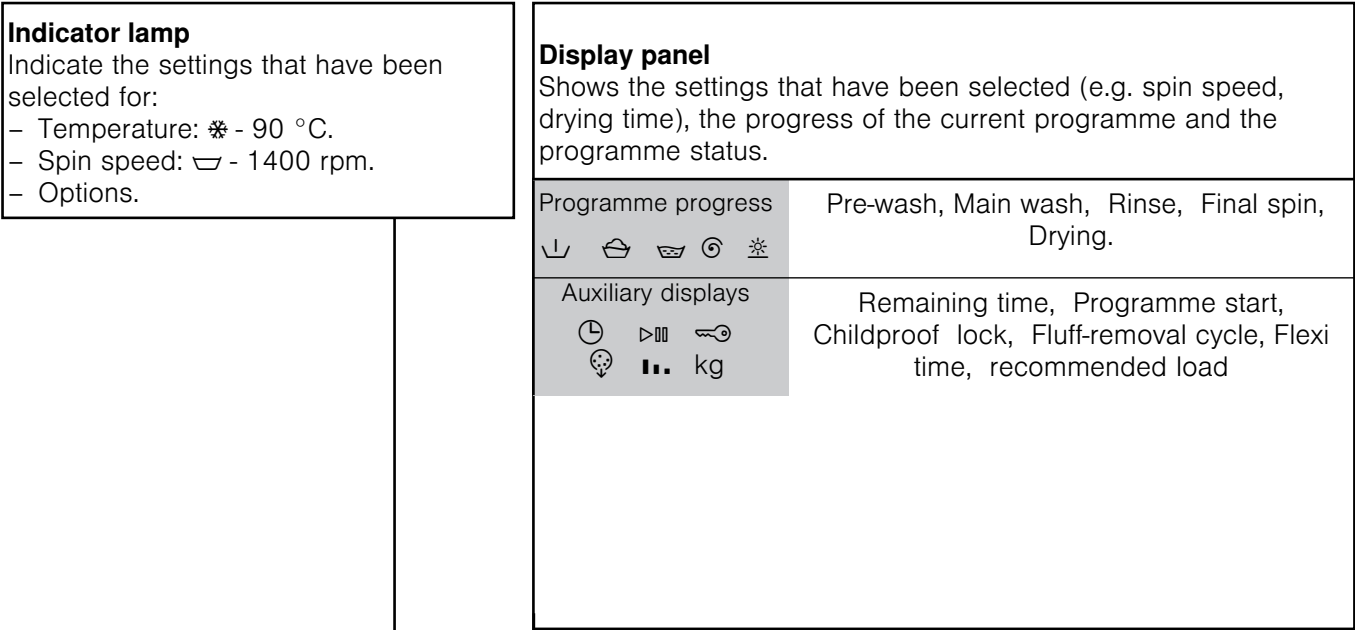

Indicator lamp **Display panel**

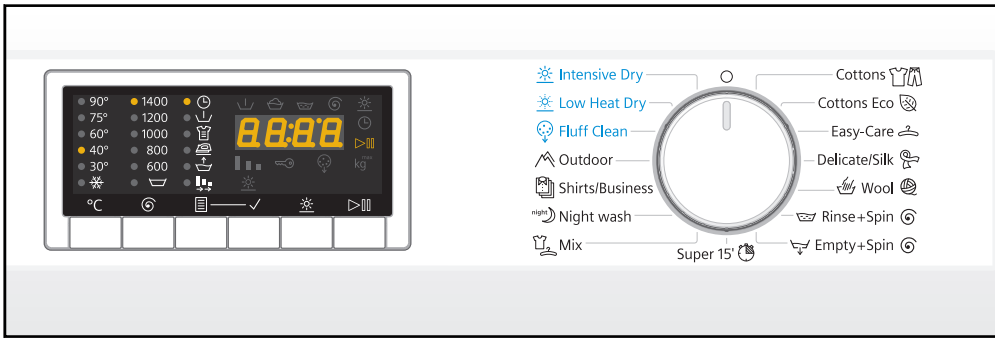

Buttons **Programme selector**

Washing and drying options -> page 16

- **Temperature °C:** individual adjustment of the washing temperature.
- **Spin speed ☹:** individual adjustment of the spin speed.
- **Option button:** sets washing options.
- **Set button:** activation/deactivation of the selected washing options.
- **Drying ☼:** sets the drying time

Start/Pause ▶⏸:
Starts and stops the washing programme -> page 17.

Programme selector -> page 14
For switching the washer-dryer on and off and for selecting the programme, can be turned in both directions. Do not adjust the programme selector while washing/drying is in progress.

Before washing for the first time

The washer-dryer was tested before leaving the factory. To remove any water that may be left over from the test, you should not load any laundry the first time that you run a wash programme.

- Make sure that the transport safety bolts on the rear of the washer-dryer have been removed → page 27.
- Do not load any laundry.
- Close the door.
- Turn on the tap.
- Pull out the detergent drawer.
- Add ½ a measuring cup of detergent to **compartment II** → page 12.

i Do not use detergents for wool or delicates (these cause foam to be created).

- Close the detergent drawer.
- Turn the programme selector to **the 60°C** programme.
- Press the ▶|| (Start/Pause) button.
- At the end of the programme, turn the programme selector to **Off**.
- Open the door.

i Leave the door open to allow the inside of the washer-dryer to dry out.





Preparing and sorting the laundry

Sorting laundry for washing

Sorting laundry according to the information on the care labels

- Wash white laundry separately from coloureds.
- Unhemmed or torn items should not be washed in the machine, as they may fray.
- The laundry may be damaged if you do not observe the fabric care symbols.

Only wash laundry with the following care labels:



Care label	Type of laundry
	Cottons 90 °C.
	Coloureds 60 °C, 40 °C, 30 °C.
	Easy-care 60 °C, 40 °C, 30 °C.
	Hand- and machine-washable silk, 40 °C, 30 °C, cold.

Do  **not** wash laundry with the care symbol in the washer-dryer

Sorting laundry for drying

Sorting laundry according to the information on the care labels

Only dry laundry that is labelled "**suitable for tumble-drying**" or which has the following care symbols:

Care label	Type of laundry
	Dry at normal temperature
	Dry at low temperature (delicate drying)

Do **not** wash the following fabrics in the washer-dryer:

- Do not machine dry laundry with the  care symbol.
- Airtight fabrics (e.g. rubber-coated fabrics).
- Delicate materials (silk, curtains made from synthetic fabrics) - **they may crease.**
- Dripping-wet laundry - **high energy consumption**
- Wool or fabrics containing wool.

Preparing laundry for washing

Loose foreign bodies (e.g. coins, paper-clips, needles, nails) may damage the laundry and components of the washer-dryer (e.g. the drum).

- Empty the pockets of all items.
- Brush any sand out of pockets and collars.
- Pretreat any stains.
- Close zips, do up cover buttons.
- Remove curtain fittings or place curtains in a laundry bag.
- Wash the following in a laundry bag/pillowcase:
 - Delicates, e.g. tights, curtains,
 - Small items, e.g. socks or handkerchieves,
 - Underwired bras (the underwiring may come loose during the washing process and cause damage).
- Turn trousers, knitwear and jersey fabrics, e.g. hosiery, T-shirts or sweatshirts, inside out.

Preparing laundry for drying

- Only dry fabrics that have already been washed, rinsed and spun.
- Also spin easy-care fabrics before drying.
- Sort the items for washing according to material and desired level of dryness to ensure even drying.

Loading the laundry



Before loading the washer-dryer, make sure that there are no foreign bodies or pets in the drum.

Risk of explosion. items that have been treated with cleaning agents containing solvents, e.g. stain remover or, must be carefully rinsed out before they are loaded into the washer-dryer, otherwise there is the risk of an explosion.

- Unfold the laundry and place it loosely in the drum. Load a mixture of small and large items.
- Observe the maximum load, Programme table → page 30.
- Take care not to trap items of laundry between the door and the rubber seal.
- Close the door. You will hear it click shut.
- Measure out and add detergent and care products for just a washing programme or a combined washing and drying programme.
- Turn on the tap.

Detergents and Care Products

Detergent drawer

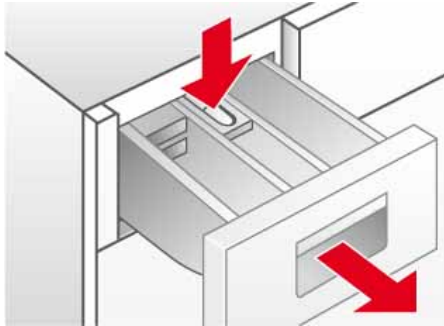

The detergent drawer is divided into three compartments

Compartment I : detergent for Pre-wash

Compartment II : detergent for Main wash

Compartment ☼ : Liquid additives, such as starch or fabric softener. Additives are automatically dispensed during the final rinse cycle.

- Do not exceed the maximum capacity, otherwise compartment ☼ may be emptied too early.
- Dilute viscous additives with water to prevent blockages.

Liquid detergent insert: this must be inserted before liquid detergents are used.

To do this:

- Pull out the detergent drawer as far as the stop.
- Press on the zone labelled **PUSH** and take out the detergent drawer.
- Pull the insert in **compartment II** forwards as far as the stop **and** push it down.
- Insert the detergent drawer.

Descaler

Descaler can be added to **compartments I** and **II** according to the manufacturer's instructions. Add detergent first, followed by the descaler.

Detergents and care products



Risk of poisoning

Keep detergents and care products out of the reach of children.

Risk of chemical burns

Take care when opening the detergent drawer. There may still be detergent residues in the drawer.

Select the correct dosage for the detergent according to:

- the water hardness. You can find out about water hardness in your area from your local waterworks.
- the load size,
- the instructions of the detergent manufacturer.
- how dirty the laundry is.

i Using the correct dosage reduces the impact on the environment and gives a good washing result.

i Only use pH-neutral wool detergent for woollens programmes.

Measuring washing powder

Normally soiled laundry

- Set the programme.
- Do **not** select  **Pre-wash** -> page 16.
- Add all the detergent, according to the manufacturer's instructions, to **compartment II** of the detergent drawer.

Heavily soiled laundry

- Set the programme.
- Select  **Pre-wash** -> page 16.
- Add 1/4 of the recommended amount of detergent to **compartment I** of the detergent drawer and 3/4 of the detergent to **compartment II**.

Measuring liquid detergent

Only use liquid detergent for the main wash cycle **with no prewash**.

To do this:

- Pour the recommended amount of detergent into a measure for liquid detergent and place it in the drum.

or

- After folding down the **liquid detergent insert**, pour the detergent into **compartment II** of the detergent drawer.

 The scale on the **liquid detergent insert** helps to measure the correct dosage of liquid detergent.

 If **compartment II** is used for washing powder, the **liquid detergent insert** must be folded up.

Programmes

Programme selector

The programme selector is used to set the washing and drying programmes.



The time remaining until the end of the programme and the recommended load are shown on the display panel.

Washing programmes*

*depends on the model

Cottons

Suitable for hard-wearing fabrics, heat-resistant fabrics made from cotton or linen.

- Coloureds up to 60 °C.
- Whites 60 °C to 90 °C.

Cottons Eco

Washing programme for the best possible washing result with minimum energy and water consumption.

Easy Care

Washing programme for less hard-wearing fabrics made from cotton, linen, synthetic fibres or blended fabrics. It is advisable to sort the laundry by colour.

Delicate/Silk

Gentle programme for delicate, washable fabrics, e.g. silk, satin, synthetics or blended fabrics (e.g. curtains). Gentle spinning between the rinse cycles and reduced final spin speed.

Wool **(Woollens)**

Wool becomes matted when subjected to heat, moisture and movement. The woollens programme takes these qualities into account and finds a compromise between standing still and movement.

Suitable for hand or machine-washable fabrics made from wool or a wool blend.

Super 15' **(Rapid 15)**

Short programme for easy-care, lightly soiled fabrics made from cotton, linen, synthetics or blends. Suitable for freshening up items or for washing new items before wearing for the first time. The programme takes 15 minutes.

Mix

For mixed items of laundry made of various hard-wearing and easy-care fabrics.

Night wash

Particularly quiet wash programme with a reduced final spin.

Sleep mode. Once the programme has finished, the display goes out, but can be reactivated by pressing any button.

Washing programmes*

*depends on the model

Shirts/Business

Non-iron shirts made of cotton, linen, synthetic fibres or blended fabrics. Gentle spin only, hang up dripping wet.

Outdoor

For washing functional clothing and sports wear made from microfibre and synthetics. Reduced creasing and additional rinse cycle.

Drying programmes

Intensive Dry

Intensive drying for  (robust fabrics).

Low Heat Dry



Gentle drying for  (easy-care fabrics).

Special programmes



Fluff Clean



The drum must be empty.

This programme is designed to clean the drying cycle of any fluff deposits. The washer-dryer uses the flashing symbol  (**Fluff removal cycle**) in the display panel to show that this programme must be run. The  (**Fluff removal cycle**) symbol goes out after the programme starts.

To run the **Fluff removal cycle**, proceed as follows:

- Make sure that the drum is completely empty and close the door.
- Set the programme selector to  (**Fluff-removal cycle**).
- Press the  (**Start/Pause**) button.







The  (**Fluff-removal cycle**) programme can also be run at any time without prompting by the appliance.

Rinse + **Spin**

An additional rinse cycle with a final spin. If the laundry is to be removed dripping wet, set the Spin speed to  (**Rinse hold**) before Programme start -> page 16.





Empty + **Spin**

Drain the rinsing water following a programme with  (Rinse hold) -> page 16.

- Turn the programme selector to **Empty**  + **Spin** .
- Set the Spin speed to  (**Rinse hold**).
- Press the  (**Start/Pause**) button.

or

Drain **and** spin at the desired spin speed:

- Turn the programme selector to **Empty**  + **Spin** .
- Press the  **Spin** button repeatedly until the desired spin speed is set.
- Press the  (**Start/Pause**) button.

Washing and drying options

Temperature °C button

The temperature can be adjusted individually for each programme. To adjust it, press the **°C Temperature button** repeatedly until the required temperature is displayed.

Spin speed button

The spin speed can be individually adjusted for each programme. To set the spin speed, press the **Spin button** repeatedly until the required spin speed is displayed.

Rinse Hold

 **(Rinse hold)** deactivates the spin function. The laundry remains in the rinsing water.

Unbalanced load detection system

The automatic unbalanced load detection system ensures that the laundry is evenly distributed using several initial spins. If the laundry is extremely unevenly distributed, the speed of the final spin is reduced or the spin cycle is not performed for safety reasons.

Option button

The set programmes can be individually adjusted.

To choose the required option:

- Press the **Option button** repeatedly until the required option is selected (indicator lamp flashes).
- Press the **Set button** to switch the option on/off (indicator lamp lights up/does not light up).

Set button



If you press and hold the **Option button**, all the options scroll through.

Options (symbols on the display panel)

Finished in button

You can postpone the Programme start before it begins. Using the Remaining time, you can determine when the selected programme is to end. The remaining time can be set in one-hour increments, up to a maximum of 24 hours. Press the **Finished in** button repeatedly until the required number of hours is displayed.

Then press the **Start/Pause** button, the programme will start after a delay according to the set Fertig in Zeit (Finished in time). The required time to the end of the programme is shown on the display panel.

Pre-wash

Prewash at 35 °C. Suitable for heavily soiled laundry.

Intensive

Washing time lengthened at 60 °C. Suitable for delicate, soiled laundry. Cannot be combined with **Flexi Time**

Easy-iron

Special spin sequence with subsequent fluffing. Gentle final spin at reduced speed. Slightly increased residual moisture in the laundry. Reduces creasing and laundry is easier to iron.

Water plus

Increased water level and additional rinse cycle. For regions with very soft water or for further improving the rinsing result. Any detergent residues are removed.

Flexi Time

Sets the washing time, *normal-medium-short*.

Drying button ☼

The drying programmes → page 15 can be individually adapted by selecting the drying time.

- Press the ☼ (**Drying**) button repeatedly until the required drying time is shown on the display panel.
- To deactivate, press the ☼ (**Drying**) button repeatedly until  is shown on the display panel.



Drying options (symbols on the display panel)

 Time-controlled drying The drying time can be set to between 2:40 and 0:00 by repeatedly pressing the ☼ (**Drying**) button.

Start/Pause button





Press the  (**Start/Pause**) button to start the selected programme.



The  (Remaining time) appears on the display panel. The  symbol (Programme start) lights up.

Programme progress

The programme progress is shown on the display panel:

-  - Pre-wash
-  - Main wash
-  - Rinse
-  - Final spin
-  - Drying

Changing the programme





To change the programme:

- Select a new programme.
- Press the  (**Start/Pause**) button.



The new programme starts.

Pausing the programme



Press and hold the  (**Start/Pause**) button while the programme is in progress until  appears on the display panel.  and the Remaining time  appear alternately on the display while the programme is paused.

Press the  (**Start/Pause**) button to continue with the programme.

Cancelling the programme

Press and hold  (**Start/Pause**) until  is displayed.

For washing programmes at high temperatures:

- Cooling down laundry: choose **Rinse**  + **Spin** .
- Press the  (**Start/Pause**) button.

For programmes at low temperatures:







- choose **Empty**  + **Spin** .
- Press the  (**Start/Pause**) button.



If you cancel the drying programme, the laundry may still be very hot.







Washing and drying

Washing only

- Turn the programme selector to the desired programme, e.g. **Cottons**  **60°C**.
 -  (**Remaining time**) and the recommended load in **kg** appear alternately on the display panel. The  (**Start/Pause**) symbol flashes.
- If necessary, adjust the temperature and the spin speed and select any options for your individualised programme → page 16.
 - The  (**Drying**) function must not be selected.
- Load the laundry → page 11.
 - Observe the maximum load capacity, Programme table → page 30.
- Press the  (**Start/Pause**) button.
 -  (**Remaining time**) is displayed on the display panel. The  (**Programme start**) symbol lights up.
 - The washing programme starts.







Drying only

- Turn the programme selector to the desired drying programme.
 - The display panel alternately shows  (**Remaining time**) and the recommended load in **kg**.
- Press the  (**Drying**) button to select the drying time.
- Load the laundry → page 11.
 - Observe the maximum load, Programme table → page 30.
- Press the  (**Start/Pause**) button.
 -  (**Remaining time**) is shown on the display panel and the  (**Drying**) and  (**Programme start**) symbols light up.
 - The drying programme starts.



Washing and drying

- Successive washing and drying.
- Set the programme selector to the desired programme, e.g. **Cottons**  **60°C**.
 -  (**Remaining time**) and the recommended load in **kg** appear alternately on the display panel. The  symbol flashes.
 - If necessary, adjust the temperature and the spin speed and select any options for your individualised programme → page 16.
 - Press the  (**Drying**) button to set the drying options → page 17
 - Load the laundry → page 11.
 - Observe the maximum load, Programme table → page 30.
 - Press the  (**Start/Pause**) button.





The drying programme that is carried out is automatically determined by the washing programme, see the Programme table → page 30.

End of the programme



The washing and drying programmes are ended automatically.  appears on the display panel.

- Set the programme selector to **Off**.
- Remove the washing from the drum.
- Leave the door open so that the inside of the washer-dryer can dry out.
- Turn off the tap (not necessary on models with Aqua-Stop).

Rinse Hold

If the spin function was deactivated at the start of the wash cycle,  (no final spin = laundry remains in last rinsing water), the washing programme is automatically stopped after the final rinse. The display panel shows  alternating with .



In order to drain the rinsing water and, if required, spin the laundry:

- Press the  (**Spin**) button repeatedly until the required spin speed is set. The water is drained and the washer-dryer spins the laundry. The programme is completed when  appears in the display field.



The maximum spin speed depends on the selected wash programme.





If you do **not** wish to spin the laundry:

- Press the  (**Spin**) button until the Rinse Hold option is selected again (indicator lamp lights up). The pump-out will be run without spin. The programme is complete when  appears on the display panel.
- Set the programme selector to **Off**.
- Remove the laundry.
- Leave the door open to allow the inside of the washer-dryer to dry out.
- Turn off the tap (not necessary on models with Aqua-Stop).

Childproof lock

For preventing the washer-dryer functions that you have set from being changed inadvertently.

Activate/deactivate:

- Press and hold the **Set** button  until the Childproof lock symbol  starts to flash for 3 seconds.
- Press the **Option** button  within these 3 seconds to activate or deactivate the Childproof lock.
- The symbol  lights/disappears when activated/deactivated.

Cleaning and care

Safety information

Risk of electric shock

You must disconnect the appliance from the mains first. Never clean the washer-dryer with a water jet.



Risk of explosion.

Never clean the washer-dryer with solvents.

Risk of scalding

Hot washing water must be cooled before draining.

Housing and control panel

Wipe with a soft, damp cloth.



Remove detergent and cleaning agent residue immediately.

Do not clean with a jet of water.

Drum

Remove any foreign bodies from the drum and rubber seals.

Descaling the drum:

- Only use a proprietary brand of descaler with corrosion inhibitor for washing machines for descaling the washer-dryer.
- Observe the manufacturer's instructions regarding use and dosage.
- After descaling and removing rust from the drum, run the **Rinse**  + **Spin**  programme several times to remove any remaining acid.

If any remaining metal objects (e.g. coins, paper clips, needles, nails) have caused rust spots:

- Use chlorine-free cleaning agents; observe the manufacturer's instructions. Never use steel wool.

Detergent drawer

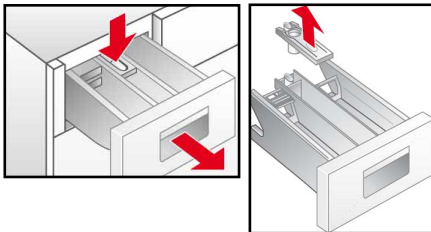

If there are detergent or care product residues:

- Pull out the detergent drawer as far as the stop.
- Press on the blue zone labelled **PUSH** and take out the detergent drawer.
- Clean the detergent drawer guide.
- Remove the blue fabric softener compartment insert.
- Clean the detergent drawer and fabric softener compartment insert under running water.
- Insert the fabric softener compartment insert.
- Insert the detergent drawer.

Drain pump

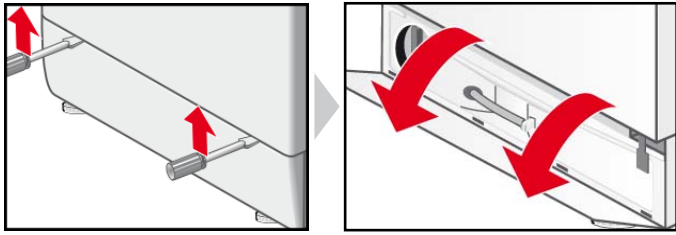

- Set the programme selector to **Off**.
- Use a screwdriver to release the lock pins.
- Tip the kick panel and pull upwards to remove.

Draining the water



- Take the drain hose out of the retainer.
- Remove the plug from the drain hose and release the washing water.
 - The container for the drained water may have to be emptied several times.
 - When no more water runs out, replace the plug.
- Place the drain hose into the retainer.

Cleaning the drain pump

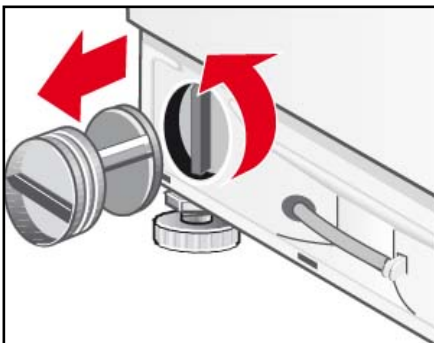

- Unscrew the pump cover.
 - Clean the pump housing and remove any foreign objects.
 - Make sure that the impeller can turn freely.
- Replace the pump cover and screw firmly in place.
- Place the kick panel in the 4 clip-in slots and secure to the housing using the lock pins.

Filter in the water supply hose

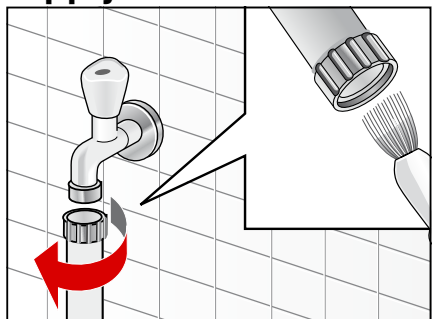

If no water runs into the washer-dryer, or only an insufficient amount, you must first reduce the water pressure in the supply hose:

- Turn off the tap.
- Choose any programme (except **Rinse** + **Spin** / **Empty** + **Spin**).
- Press the (**Start/Pause**) button.
- Allow the programme to run for approximately 40 seconds.
- Set the programme selector to **Off**.
- Unplug the mains plug from the socket.
- Unscrew the water supply hose from the tap.
- Clean the filter with a small brush.
- Reconnect the hose.
- Turn on the tap.
- Check whether water comes out of the end of the hose.
- If water is escaping, check that the filter is correctly seated.

Descaling the washer-dryer

This should not be necessary if the correct detergent dosage has been used. If it is necessary, however, proceed according to the descaling agent manufacturer's instructions. Suitable descalers can be obtained via our website or from our after-sales service → page 25.

What to do if...



Risk of electric shock

Repairs must only be carried out by customer services or authorised technicians.

If repairs are needed, or if you cannot rectify a fault yourself with the help of the following table:

- Set the programme selector to **Off**.
- Disconnect the washer-dryer from the power supply.
- Turn off the tap.
- Call the after-sales service → page 25.



Fault code

	The door is not closed properly. Try to close the door properly.
	The water protection system has been activated. Disconnect the appliance from the mains, turn off the tap and contact the after-sales service
	Water is not entering the appliance. See the fault Water is not flowing in .
	The water is not drained. See the fault Water is not drained .
	Not a fault! The unbalanced load detection system has detected an unbalanced load caused by laundry items. The fluff removal cycle cannot start. Remove the laundry.
	Maximum or minimum drying load not taken into account. HI/End or LO/End flash alternately in the display. See information for the Drying result not satisfactory fault.

Other fault codes are only for use by the after-sales service. Make a note of the fault code to inform the after-sales service.

Fault	Possible cause	Remedial action
Programme does not start.	The ▶ (Start/Pause) button has not been pressed.	Press the ▶ (Start/Pause) button.
	A delayed start time has been selected.	The washer-dryer starts once the delay time has elapsed. If necessary, change the finished in time → page 16.
	Power cut. The delayed start time that was selected has been cleared.	Make a new delayed start time selection or start a programme immediately: Press the ▶ (Start/Pause) button.
	The door is not properly closed.	Close the door.
	Plug not inserted properly into socket.	Insert plug correctly.
The maximum spin speed cannot be set.	The maximum spin speed depends on the programme selected.	Change programme as required.
The water is not drained.	Drain hose is twisted.	Fit the drain hose correctly.
	Detergent pump is blocked.	Clean the drain pump → page 21.
Detergent residues in the detergent drawer.	Damp or lumpy detergent.	Clean and dry the detergent drawer –> page 20.
		Use the measuring aid for liquid detergent.

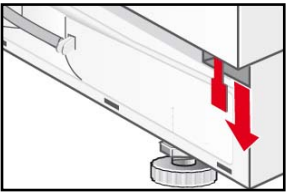
Water is not flowing in.	The mains plug is not correctly plugged in.	Plug in the mains plug correctly.
	The door is not properly closed.	Close the door.
	The tap is not turned on.	Turn on the tap.
	The filter in the water supply hose is blocked.	Clean the filter in the water supply hose → page 21.
	The water supply hose is pinched or kinked.	Check the water inlet hose.
Intense vibrations during spinning.	The washer-dryer is not correctly levelled.	Level the washer-dryer → page 28.
	The transport safety bolts have not been removed.	Remove the transport safety bolts → page 27.
Washer-dryer fills with water and continuously drains it away.	Drain hose fitted too low.	Fit the drain hose correctly – > page 29.
No water can be seen in the drum.	Not a fault.	During certain programmes the water level is below the visible range.
Water leaks from the bottom of the appliance.	Supply hose screw connection is leaking.	Tighten the screw connection.
	Drain hose is leaking.	Have the drain hose replaced by the after-sales service.
Foam escapes from detergent drawer.	Too much detergent has been used.	Only use detergent which is correct for textiles, and suitable for use in automatic washing machines. Make sure that you use the correct dosage.
Several attempts to start spinning.	Not a fault. The unbalanced load detection system attempts to redistribute an unbalanced load by starting to spin several times.	Always wash large and small items together.
Washing is not spun properly.	Large items of laundry are not evenly distributed in the drum. The spin speed is automatically reduced for safety reasons.	Always wash large and small items together.
Washing results not satisfactory.	Uncleaned areas worse than expected.	Select a suitable programme, e.g. a programme with prewash. Pretreat stains if necessary.
	Too little or incorrect detergent used.	Use the correct dosage of a suitable detergent, in accordance with the manufacturer's instructions.
	Maximum load exceeded.	Select the correct load for the programme.
Detergent residues on the washing.	Some phosphate-free detergents contain water-insoluble residues which appear on washing as light specks.	Rinse the laundry again or change to using liquid detergent. Brush the laundry after it has dried.
Grey residues on the washing.	Soiling caused by ointments, grease or oil.	Wash the laundry using the maximum detergent dosage and the maximum permissible temperature – see the care label.
Programme terminated unexpectedly.	The ▶ (Start/Pause) button was selected accidentally.	Press the button again to restart the programme.

Spinning during drying	No fault	"Thermo spin", which is for energy-efficient drying, starts after a drying time of approx. 10 minutes.
Drying result not satisfactory.	The laundry clings to the sides of the drum after being spun.	Loosen up the laundry by hand, start the drying programme → page 18.
	Closed tap	Turn on the tap.
	Selected drying time too short.	Select the drying time according to the load size.
	Maximum or minimum load not taken into account → page 30.	Once the programme has ended: adjust the load quantity, select a suitable drying programme and restart.
The fabric softener is not completely flushed in or too much water remains in the compartment ☼.	The fabric softener compartment insert is not correctly attached or is blocked.	If necessary, clean the fabric softener compartment insert and fit it correctly in compartment ☼.
The laundry is not dried.	The tap is turned off.	Turn on the tap.
	The load is too large.	Reduce the load size.
	The drying time is too short.	Select a suitable drying time.
No display on the display panel.	Power cut.	The programme continues when power is restored. If you wish to remove the laundry during a power cut, you must first drain out the water → page 21. Check whether: - the plug is plugged into the socket correctly - the circuit breaker (fuse) has tripped; call the after-sales service. – > page 25.
Door cannot be opened.	☹ (Rinse hold) has been selected.	Select the programme Empty ☹ + Spin Ⓞ and press ▷ Start/Pause .
	The programme is running or the door is locked for safety reasons.	Wait until  appears on the display panel.
	Power cut.	Unlock the door mechanically.
Emergency release	To release the door mechanically in the event of a power cut:	
	<input type="checkbox"/> turn the programme selector to Off and unplug the mains plug from the socket.	
	<input type="checkbox"/> open the base panel and drain out the water → page 21.	
	<input type="checkbox"/> remove the panel.	
	<input type="checkbox"/> pull the emergency release downwards and open the door at the same time.	
	Before opening the door, make sure that there is no water or hot detergent solution in the washer dryer.	
	Under no circumstances open the door with the emergency release while the drum is still turning.	

If you cannot correct a fault yourself (switching on/off) or a repair is required:
– Turn the programme selector to Off and unplug the mains plug from the socket.
– Turn off the tap and call the after-sales service → page 25.

After-sales service

Before you call the after-sales service, please check whether you can correct the fault yourself -> page 22.

You will be charged if a technician is called out, even during the warranty period.

You can find information about your nearest after-sales service here or in the After-sales service directory (depending on the model).

Please give the after-sales service the product number (E-Nr.) and production number (FD) of the appliance.

E-Nr. _____ FD _____

Enter the numbers of your appliance here.

You can find this information on the rating plate in the frame of the door.

Please help us to avoid unnecessary call-outs by quoting the product and production numbers. This will also save you the associated additional costs.

You can rely on the competence of the manufacturer. Please contact us. This way, you can ensure the repair is carried out by trained service technicians who are equipped with genuine spare parts.

Installation instructions

Safety information



The washer-dryer is very heavy. Take care when lifting it.

Do not operate the washer-dryer if it has any visible damage. If you are in any doubt, please consult our after-sales service or your retailer.

Do not install the washer-dryer outdoors or in areas exposed to frost. Frozen hoses can crack or burst. As a result, the washer-dryer could be damaged.

Do not stand the washer-dryer upside down or on its side. Do not lift the washer-dryer by protruding parts (e.g. door).

Do not place the washer-dryer behind a door or a sliding door which could prevent the washer-dryer door from being opened. This will prevent children from locking themselves in and putting their lives in danger.

Remove the transport braces and cross connectors and store in a safe place.

In addition to the instructions provided in this document, special regulations from the relevant water and electric utility companies may apply.

If in doubt, have a technician connect the appliance.

Included with the appliance

Number	Description
5	Covers for openings left after removing the transport bolts.
1	Spanner
1	24-40 mm dia. hose clamp for connection to a siphon.

On the back of the washer-dryer:

- Water drain hose
- Water supply hose
- Mains cable with plug
- Instruction manual and booklet containing after-sales service addresses

Moisture may remain in the drum following the final inspection which every washer-dryer undergoes before leaving the factory.

Removing the transport safety bolts

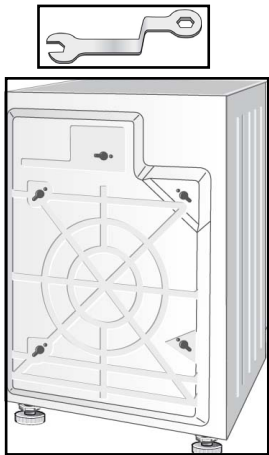
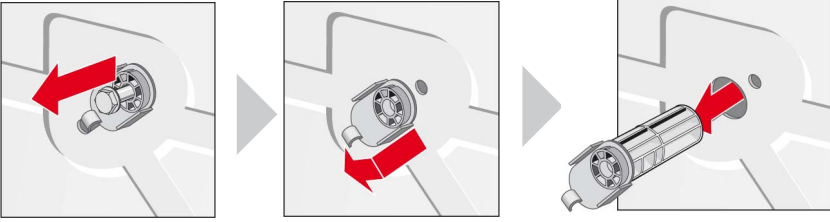
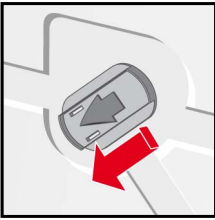
	
	<p>Unscrew all screws using the spanner supplied</p>
 <p>Insert the protective covers.</p>	<ul style="list-style-type: none"> – Before using the appliance for the first time, you must make sure that all transport safety bolts have been removed and kept safe for any subsequent transport. – If you need to transport the appliance at a later date, always re-affix the transport safety bolts to prevent damage to the machine.

Positioning and levelling

- Appliance stability is essential to ensure that the washer-dryer does not “creep” during spin cycles.
- The installation area must be firm, clean and level.
- Parquet floors and soft floor coverings, e.g. carpets or foam-backed floor coverings, are unsuitable.

Positioning

- Slide sheets make it easier to slide the washing machine into the installation recess.
- Can be ordered from the after-sales service, spare part no. 66 1827.
 - Moisten the slide sheets with a mixture of water and washing-up liquid before sliding the machine into place. Do not use grease and/or oil.

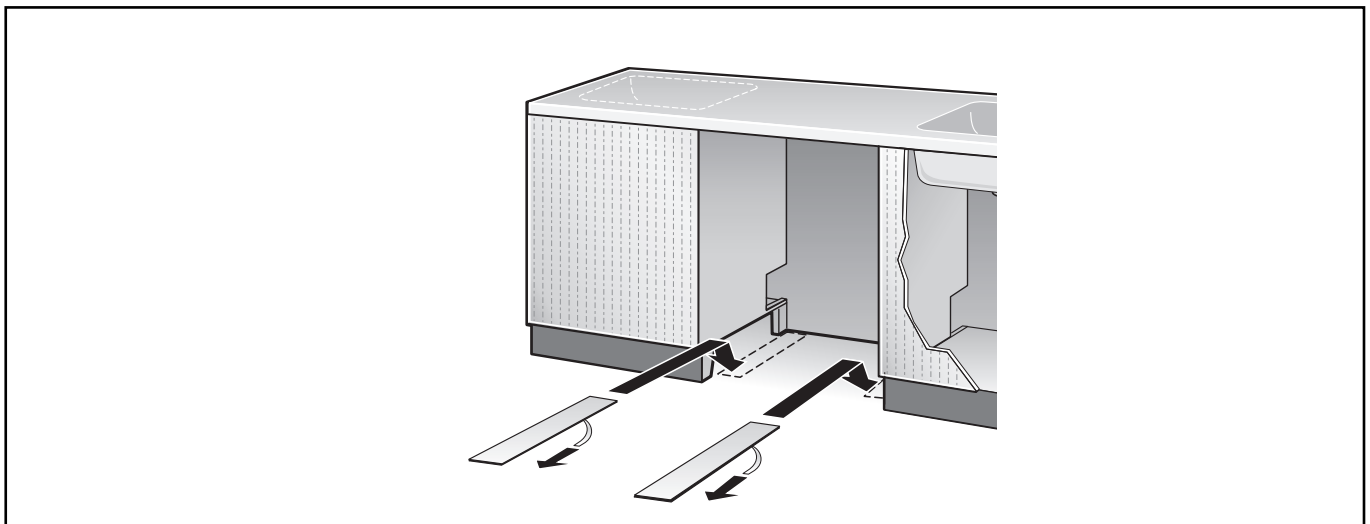

Levelling

Intense noise, vibrations and “wandering” may be the result of incorrect levelling.

- All four appliance feet must be firmly on the ground.
- The washing machine must not wobble.
- Check the alignment of the washing machine with a spirit level and adjust if necessary.
- The washing machine must not rest against the side panels of the installation recess.
- The lock nuts of the front appliance feet must be screwed tightly against the housing.

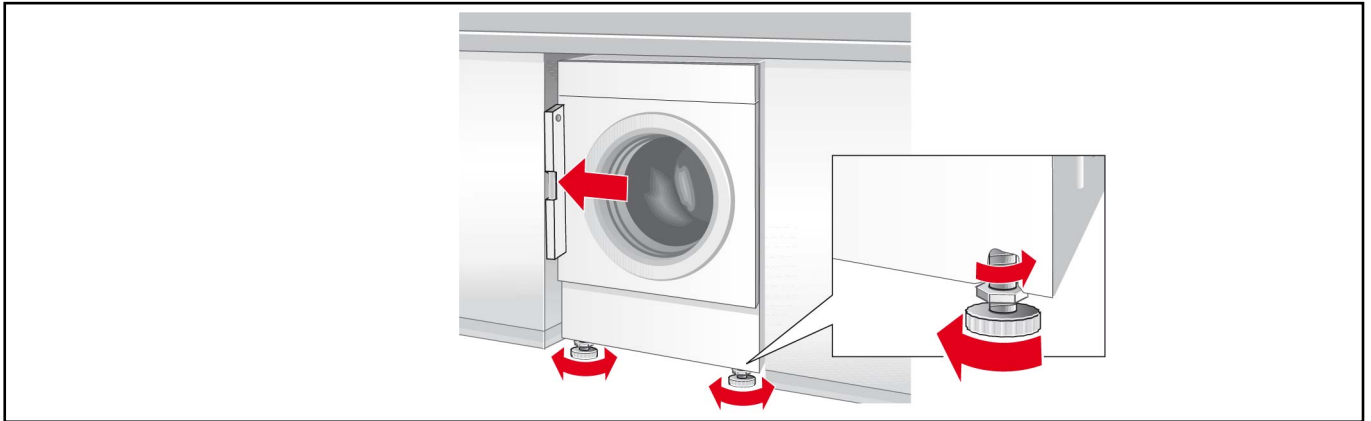

Hose and cable lengths

Left-hand connection

or

Right-hand connection

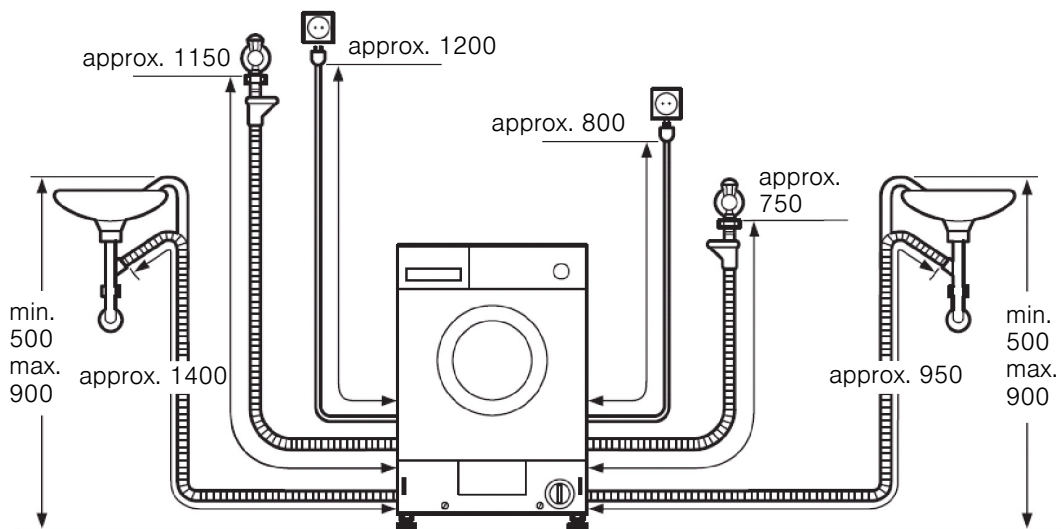

Dimensions in mm

Dimensions

Width x depth x height

595 mm x 584 mm x 820 mm

Weight

85 kg

Water connection

To prevent leaks or water damage, you must observe the instructions in this section.

If in doubt, have a technician connect the appliance.

The water supply and drain hoses can be routed to the left or right, depending on installation conditions.

Do not use a used inlet hose. Only use the inlet hose supplied or one which was purchased from an authorised specialist retailer.

Water supply

Do not allow the water supply hose to be:

- kinked or squashed
- altered or cut (strength no longer guaranteed).

Note the water pressure in the mains supply:

The water pressure should be between 50-900 kPa (0.5-9 bar) (at least 8 litres of water flow out per minute when the tap is turned on).

If the water pressure is higher, a pressure reducing valve must be fitted.

Connect the cold-water supply hose (**blue** union nut) to the cold water tap with $\frac{3}{4}$ " pipe thread.

Only tighten plastic screw connections by hand.

Do not remove the filter from the supply hose.

After connecting the water supply hose:

- Turn the tap on fully.
- Check the connections for leaks.

Water drainage

Drainage into a siphon

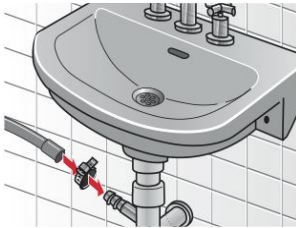

- Do not kink the drain hose or pull it lengthways.
- Height difference between the installation surface and the drain: max. 90 cm, min. 50 cm.

Secure the connection with a 24-40 mm hose clamp (available from specialist retailers).

Electrical connection

The washer-dryer must only be connected to an alternating current supply via a properly installed earthed socket.

If a residual current circuit breaker is used, only use a type which displays this symbol: .

Only this symbol guarantees compliance with the currently applicable regulations.

The mains voltage must match the voltage specifications on the washer-dryer (rating plate).

The connected load and fuse required are shown on the rating plate.

Make sure that:

- the mains plug fits the socket.
- the cable cross-section is adequate.
- the earthing system is properly installed.
- the appliance is not standing on the mains cable.
- the mains plug is accessible at all times.

Changes to the mains cable may only be carried out by a qualified electrician.











Do not use multiple plugs/adapters or extension cables.

Do not plug in or unplug the mains plug with wet hands.

Only pull the mains plug out by the plug itself.

Table of programmes





In order to select the most suitable programme for the laundry, observe the information on the labels that are attached to most items.

Programmes*	°C	max.	Type of laundry 	Options*					Drying		
				山	留	皇	👉	!!	☀	☀	
Cottons 	cold-60-90	7 kg/ 4 kg**	Hard-wearing fabrics, heat-resistant fabrics made of cotton or linen	✓	✓	✓	✓	✓	✓	☀	-
Cottons Eco 	cold-60			✓	-	✓	✓	✓	✓	✓	-
Night wash 	cold-40-60	3 kg**	Quiet wash programme with a reduced final spin	✓	✓	✓	✓	-	✓	☀	-
Easy Care 	cold-40-60	3.5 kg	Easy-care fabrics made of cotton, linen, synthetic fibres or blended fabrics	✓	✓	-	✓	✓	-	☀	✓
Mix 	cold-40	3 kg	Fabrics made of cotton or easy-care fabrics	✓	✓	✓	✓	✓	-	☀	✓
Delicate/Silk 	cold-30-40		For delicate, washable fabrics, e.g. made of silk, satin, synthetic fibres or blended fabrics (e.g. curtains)	-	✓	-	✓	-	-	☀	-
Wool 	cold-30-40		Hand or machine-washable fabrics made of wool or containing wool	-	-	-	-	-	-	☀	-
Shirts/Businessness 	cold-30-40	2 kg	Non-iron shirts made of cotton, linen, synthetic fibres or blended fabrics. Gentle spin only, hang up dripping wet.	-	✓	-	✓	✓	-	☀	-
Super 15' 	cold-30		Easy-care fabrics made of cotton, linen, synthetic fibres or blended fabrics	-	-	-	-	-	-	☀	-
Outdoor 	cold-30-40		Fabrics made from microfibre	-	✓	-	✓	✓	-	☀	-

*Programmes and options depend on the model



**Reduced load quantity for successive washing and drying programme

Consumption rates

Washing				
Programme	Load	Energy**	Water**	Programme duration**
Cottons 40 °C	7 kg	0.83 kWh	62 l	1:51 h
Cottons 90 °C		2.30 kWh	70 l	2:45 h
e Cottons eco 60 °C*		0.85 kWh	54 l	2:30 h
Mixed Fabrics 40 °C	3.5 kg	0.45 kWh	40 l	0:49 h
Easy-Care 40 °C		0.62 kWh	45 l	1:43 h
Delicates cold	2 kg	0.05 kWh	35 l	0:36 h
Delicates 30 °C		0.20 kWh	49 l	0:36 h
Wool   cold		0.10 kWh	49 l	0:47 h
Wool  30 °C		0.20 kWh	49 l	0:47 h
e Cottons eco 60 °C intensive dry  (2 cycles)	7 kg/4 kg	5.50 kWh	105 l	7:00 h
Power consumption when switched off			0.20 W	
Power consumption when left on			0.80 W	

* Program setting with maximum spin speed for testing according to IEC60456:2010 with cold water (15°C).

** The values may deviate from the stated values depending on the following factors: water pressure and hardness, inlet temperature, ambient temperature, type and amount of laundry, type and amount of detergent used, fluctuations of power supply, and additional functions selected.

Drying*			
Programme	Load	Cupboard dry*	Iron dry*
Intensive Dry 	1.5 kg	1:30 h	1:00 h
	2 kg	1:30 h	1:00 h
	2.5 kg	1:40 h	1:30 h
	3 kg	1:50 h	1:35 h
	3.5 kg	2:00 h	1:40 h
	4 kg	2:10 h	1:50h
Gentle Dry 	1.5 kg	1:30 h	1:00 h
	2 kg	1:30 h	1:00 h
	2.5 kg	1:50 h	1:30 h
	3 kg	2:10 h	1:40 h

*)The values may diverge from those specified depending on over and undervoltage, fabric type, composition of the laundry to be dried, residual moisture in the fabric and the amount of the load.

Further information about our products, accessories, spare parts and service can be found at:
www.siemens-home.com or via our after-sales service centres.

BSH Hausgeräte GmbH

Carl-Wery-Str. 34
81739 München / GERMANY

WD14D361HK,
WD14D366HK
09.2015
9001141751
19291029300

Manufactured by BSH Hausgeräte GmbH under Trademark License of Siemens AG